

High Efficiency Synchronous Rectifier Boost Converter

General Description

The uP6014 is a power supply solution for products powered by a single-cell Li-Ion or Li-Polymer battery. The uP6014 is a high efficiency synchronous step-up converter which integrated power MOSFETs and includes the output true shutdown function. The quiescent current is 50uA (Typ). The uP6014 uses fixed-frequency PWM current mode control at 500kHz for fast transient response with internal compensation. Protect function includes cycle-by-cycle current limit, output over voltage protection, over current flag and over temperature protection. The uP6014 is suitable for tablet computers, smart phones, and portable handheld devices.

The uP6014 is available in WDFN3x3-10L and PSOP-8L packages.

Ordering Information

Order Number	Package Type	Top Marking
uP6014PDDA	WDFN3x3 - 10L	uP6014P
uP6014PSW8	PSOP - 8L	uP6014P

Note: uPI products are compatible with the current IPC/ JEDEC J-STD-020 requirement. They are halogen-free, RoHS compliant and 100% matte tin (Sn) plating that are suitable for use in SnPb or Pb-free soldering processes.

Features

- ❑ Up to 90% Efficient Synchronous Boost Converter with 2.4A Output Current from 3.6V Input
- ❑ Quiescent Current < 70uA
- ❑ Shutdown Current < 1uA
- ❑ 500kHz PWM Switching Frequency
- ❑ Integrated Power MOSFET
- ❑ Internal Soft-Start to Limit Inrush Current
- ❑ Adjustable Output Voltage
- ❑ 5.2V Output Voltage (Fixed Mode)
- ❑ Protection:
 - Output Turn-Off True Shutdown Function
 - Overload/Short-Circuit Protection with Hiccup control
 - Input Under Voltage Lockout Protection
 - Output Over Voltage Protection
- ❑ WDFN3X3-10L and PSOP-8L Packages
- ❑ RoHS Compliant and Halogen Free

Applications

- ❑ Power Bank
- ❑ Portable Device
- ❑ USB OTG Output

Pin Configuration

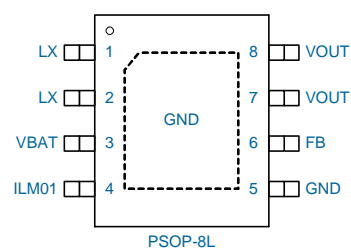
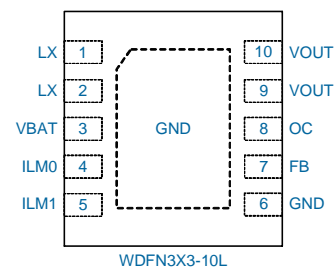

Typical Application Circuit

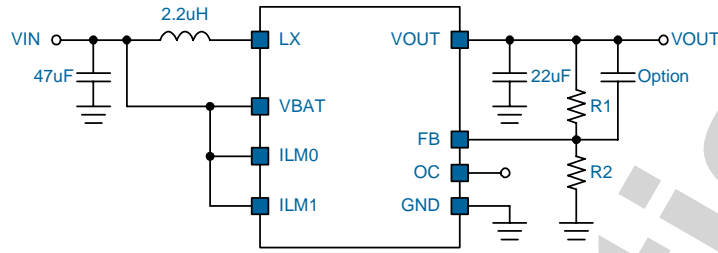

Adjustable Output Voltage by R1 and R2

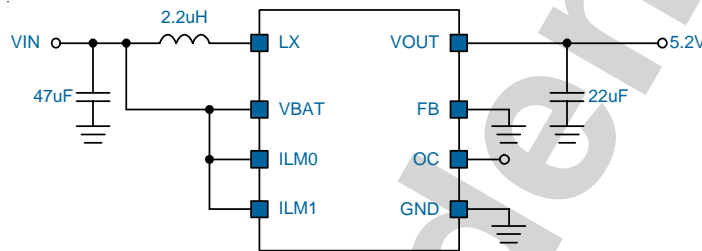

5.2V Output Voltage by Fixed Mode

Functional Pin Description

Pin No.		Pin Name	Pin Function
QSU8	QDDA		
1, 2	1, 2	LX	Switch Nodes. Connect these pins to the inductor.
3	3	VBAT	Supply Input. Input voltage that supplies current to the output voltage and powers the internal control circuit.
4	--	ILM01	Current Limit Setting. Adjustable output current limiting control pin.
--	4,5	ILM0, ILM1	Current Limit Setting. Adjustable output current limiting control pin.
5	6	GND	Ground. Ties this pin directly to the cathode terminal of CIN and COUT and ground plane with the lowest impedance. All small-signal, compensation and feedback components should connect to this pin.
6	7	FB	Feedback Voltage. This pin is the inverting input of the error amplifier. Connected to GND for Fixed Mode application.
7, 8	9, 10	VOUT	Converter Output Pins.
--	8	OC	Open-Drain Flag for Over Load, Short Circuit, and Thermal Shutdown. Active Low.
Exposed Pad			Power Ground. The Exposed Pad should be well soldered to ground plane with multiple vias for effective thermal conduction.

Functional Block Diagram

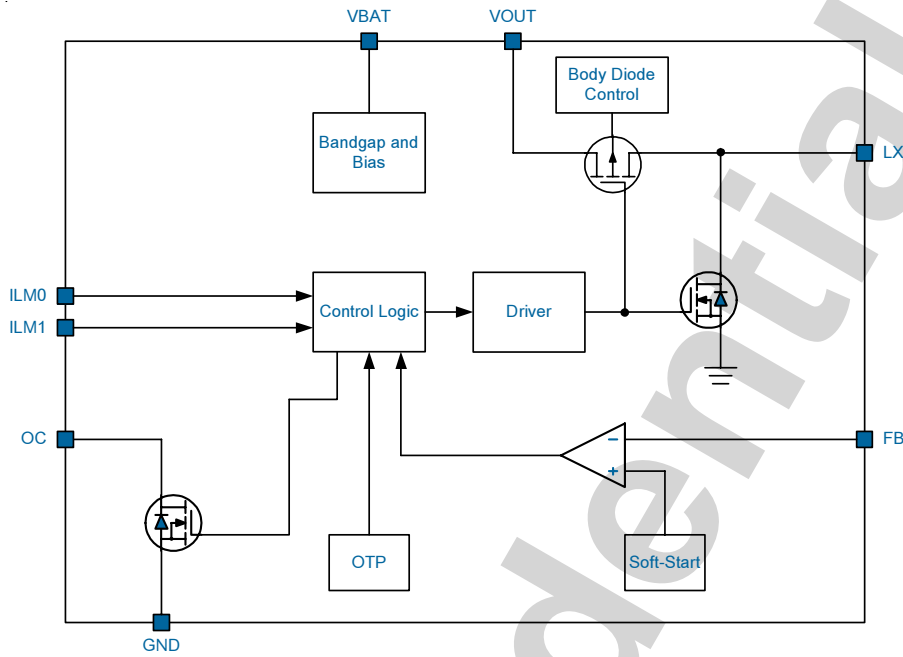

UPI Confidential

Functional Description

The uP6014 integrates an N-channel and P-channel MOSFETs to realize a synchronous rectifier. The power conversion efficiency is up to 90%. Since a typical step-up converter has a conduction path from the input to the output via the body diode of the P-channel MOSFET, a specific circuit is used to reverse the polarity of the P-channel body diode when the part is shutdown. It certainly protects battery from being completely depleted during shutdown.

Input Supply Voltage, V_{BAT}

V_{BAT} supplies current to internal control circuits and output voltages. The supply voltage range is from 2.5V to 5.5V. A power on reset (POR) continuously monitors the input supply voltage. The POR level is typically 2.2V at V_{BAT} rising. A minimum 47µF ceramic capacitor with shortest PCB traces is highly recommended for bypassing the supply input.

Current Limit Function

When the inductor current is higher than current limit threshold, the current limit function activates and forces the N-channel MOSFET turning off to limit inductor current cycle-by-cycle. The current limit threshold will be setting to 3A when $V_{BAT} > V_{OUT} - 0.5V$. If output voltage is drop under 73% (Typ) of setting, the short circuit protect function (SCP) will be active.

Output Voltage Setting and Feedback Network

The output voltage can be set from VFB to VOUT by a voltage divider as:

$$V_{OUT} = V_{FB} \times \left(1 + \frac{R1}{R2} \right)$$

The internal VREF is 1.227V with 1.5% accuracy. In real applications, a 22pF feedforward ceramic capacitor is recommended in parallel with R1 for better transient response.

Over Voltage Protection

When output voltage reached 6V (Typ), the output over voltage will be triggered to prevent external component from being damaged.

Over Temperature Protection (OTP)

The OTP is triggered and shuts down the uP6014 if the junction temperature is higher than 160°C. The OTP is a non-latch type protection. The uP6014 automatically initiates another soft start cycle if the junction temperature drops below 140°C.

Fixed Mode

The uP6014 is implemented with a fixed 5.2V output voltage function without the need of an external feedback voltage divider. If the FB pin is shorted to GND during device start-up, the uP6014 will automatically activate its internal feedback network and regulate its output at 5.2V(typ.).

Absolute Maximum Rating

(Note 1)

VOUT, VBAT, LX, ILM0, ILM1, ILM01, FB, OC to GND	-----	-0.3V to +6V
Storage Temperature Range	-----	-65°C to +150°C
Junction Temperature	-----	150°C
Lead Temperature (Soldering, 10 sec)	-----	260°C
ESD Rating (Note 2)		
HBM (Human Body Mode)	-----	2kV
MM (Machine Mode)	-----	200V

Thermal Information

Package Thermal Resistance (Note 3)

PSOP - 8L θ_{JA}	-----	47°C/W
PSOP - 8L θ_{JC}	-----	17.9°C/W
WDFN3x3 - 10L θ_{JA}	-----	68°C/W
WDFN3x3 - 10L θ_{JC}	-----	6°C/W
Power Dissipation, P_D @ $T_A = 25^\circ\text{C}$		
PSOP - 8L	-----	2.13W
WDFN3x3 - 10L	-----	1.47W

Recommended Operation Conditions

(Note 4)

Operating Junction Temperature Range	-----	-40°C to +125°C
Operating Ambient Temperature Range	-----	-40°C to +85°C
Supply Input Voltage, V_{IN}	-----	2.5V to 5.5V

- Note 1.** Stresses listed as the above *Absolute Maximum Ratings* may cause permanent damage to the device. These are for stress ratings. Functional operation of the device at these or any other conditions beyond those indicated in the operational sections of the specifications is not implied. Exposure to absolute maximum rating conditions for extended periods may remain possibility to affect device reliability.
- Note 2.** Devices are ESD sensitive. Handling precaution recommended.
- Note 3.** θ_{JA} is measured in the natural convection at $T_A = 25^\circ\text{C}$ on a low effective thermal conductivity test board of JEDEC 51-3 thermal measurement standard.
- Note 4.** The device is not guaranteed to function outside its operating conditions.

Electrical Characteristics
 $(V_{BAT} = 3.6V, V_{OUT} = 5V, L = 2.2\mu H, C_{IN} = 47\mu F, C_{OUT} = 22\mu F, T_A = 25^\circ C, \text{ unless otherwise specified})$

Parameter	Symbol	Test Conditions	Min	Typ	Max	Units
Supplies						
Supply Voltage Range	V_{BAT}		2.5	--	5.5	V
Quiescent Current	I_{BAT}	$V_{BAT} = 3.6V, FB > 1.3V, \text{ No switching}$	--	50	70	μA
Shutdown Current	I_{SHT}	$ILM0 = ILM1 = 0V, ILM01 = 0V$	--	0.1	1	μA
Under Voltage Lockout	V_{UVLO}	V_{BAT} Falling Edge	1.8	2	2.2	V
		V_{BAT} Rising Edge	2	2.2	2.4	V
Oscillator & Driver						
Switching Frequency	F_{OSC}		0.35	0.5	0.65	MHz
Maximum Duty Cycle	D_{MAX}		86	91	96	%
LX Leakage Current	I_{LX_LK}		--	1	5	μA
VOU Leakage Current	V_{OUT_LK}		--	--	20	μA
Soft Start Time	T_{SS}		6	8	10	ms
Switch On Resistance	R_{DS-P}		--	32	48	$m\Omega$
	R_{DS-N}		--	24	40	$m\Omega$
Reference						
FB Reference Voltage	V_{FB}		1.208	1.227	1.246	V
FB Sink Current	I_{FB}	$V_{FB} = 1.0V$	--	--	100	nA
Output Voltage	V_{OUT}	$I_{OUT} > 100mA \text{ at CCM}$	4.925	5	5.075	V
		$I_{OUT} > 100mA, FB = 0V \text{ (fixed mode)}$	5.122	5.2	5.278	
Logic Input						
ILM0, ILM1, ILM01 Logic Low	V_{ILM_L}		--	--	0.5	V
ILM0, ILM1, ILM01 Logic High	V_{ILM_H}		1.5	--	--	V
Open Drain MOS Resistance(OC)	R_{DS-OC}		--	50	100	Ω
ILM0, ILM1 Pull-Low Resistance	R_{ILM}		--	500	--	$k\Omega$
ILM01 Pull-Low Resistance	R_{ILM01}		--	250	--	$k\Omega$
Protection						
Thermal Shutdown Temperature	T_{SHDN}		--	160	--	$^\circ C$
Thermal Shutdown Hysteresis	ΔT_{SHDN}		--	20	--	$^\circ C$

Electrical Characteristics

Parameter	Symbol	Test Conditions	Min	Typ	Max	Units
Current Limit	I_{LX_1}	ILM0 = 0, ILM1 = 0	--	0	--	A
	I_{LX_2}	ILM0 = 1, ILM1 = 0	--	2.3	--	
	I_{LX_3}	ILM0 = 0, ILM1 = 1	--	3.9	--	
	I_{LX_4}	ILM0 = 1, ILM1 = 1	--	6.5	--	
	I_{LX_5}	ILM01 = 1 (PSOP - 8L)	5.52	6.5	7.48	
Output Over Voltage Protection	$V_{_OVP}$	Rising	--	6	--	V
Output Over Voltage Protection Hysteresis	$V_{_OVPHYS}$	Falling	--	0.2	--	V
OC De-Glitch Time	$T_{_DEGLITCH}$	OC Flag from 1 to 0	--	7	--	ms
SCP Restart Time	$T_{_RESTART}$	OC Flag keep 0	--	64	--	ms
Vout Short-Circuit Threshold	$V_{_SCP_1}$	Falling	--	Vout* 73%	--	V
		Rising	--	Vout* 81%	--	

Typical Operation Characteristics

Operating Waveform

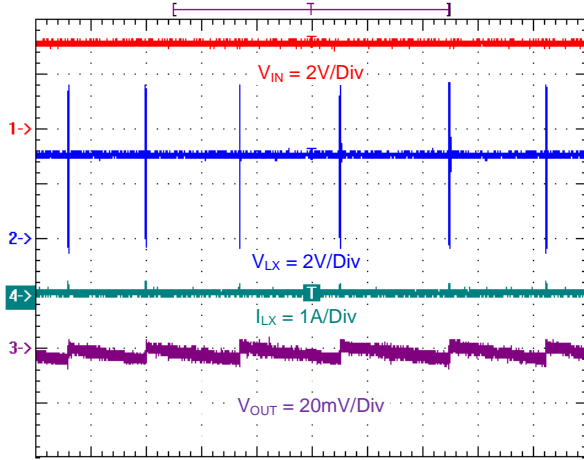

Time (1ms/Div)
 $V_{IN} = 3V, I_{OUT} = 0A$

Operating Waveform

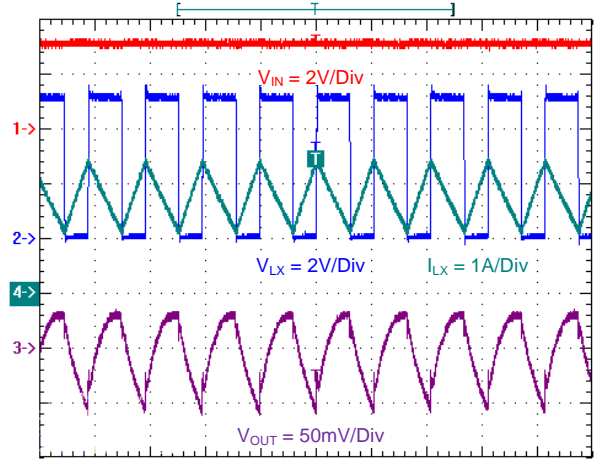

Time (2us/Div)
 $V_{IN} = 3V, I_{OUT} = 1A$

Operating Waveform

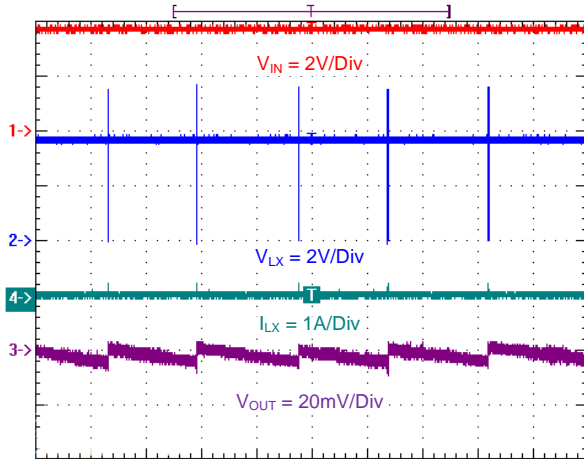

Time (1ms/Div)
 $V_{IN} = 3.6V, I_{OUT} = 0A$

Operating Waveform

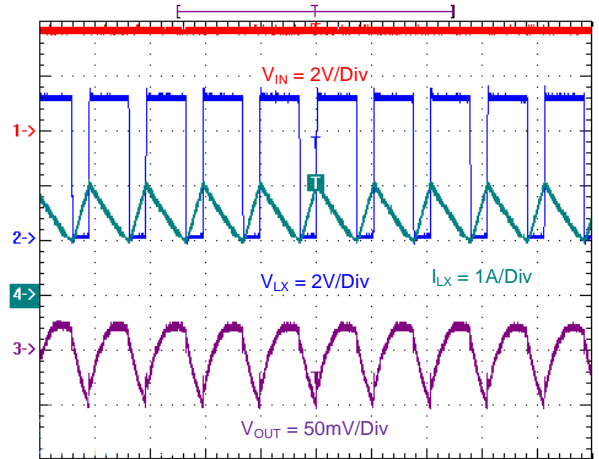

Time (2us/Div)
 $V_{IN} = 3.6V, I_{OUT} = 1A$

Operating Waveform

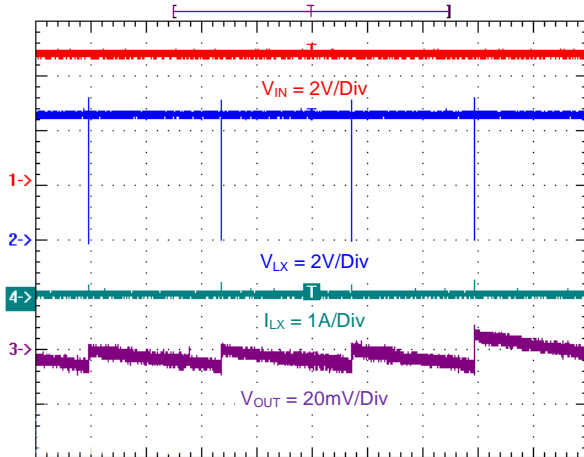

Time (1ms/Div)
 $V_{IN} = 4.5V, I_{OUT} = 0A$

Operating Waveform

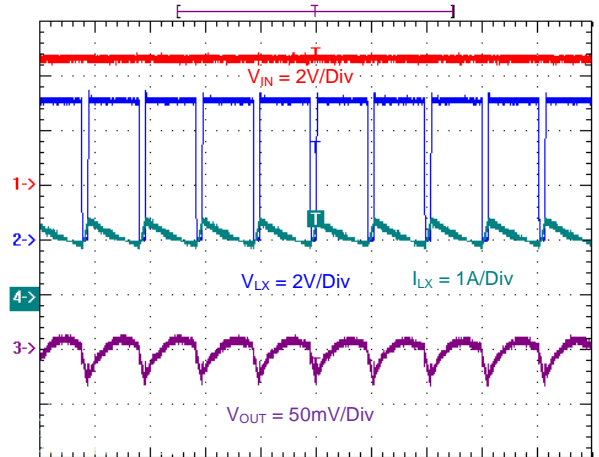

Time (2us/Div)
 $V_{IN} = 4.5V, I_{OUT} = 1A$

Typical Operation Characteristics

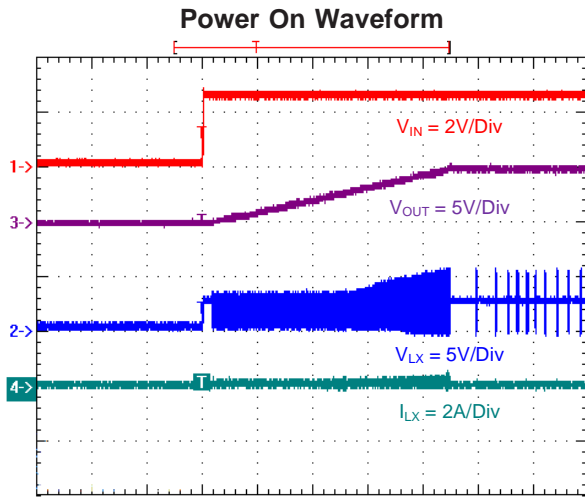

Time (2ms/Div)
 $V_{IN} = 2.5V, I_{OUT} = 0A$

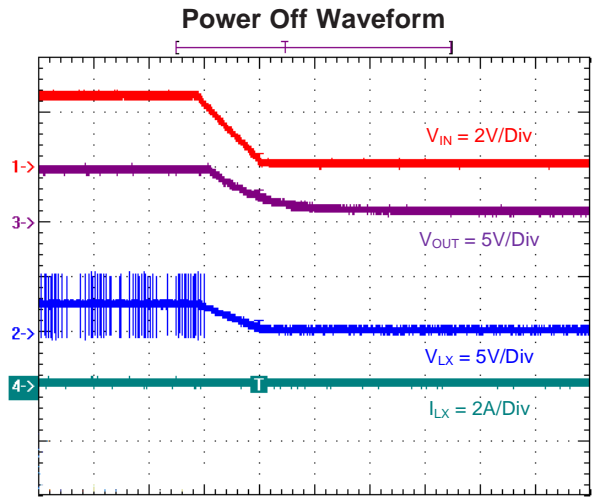

Time (20ms/Div)
 $V_{IN} = 2.5V, I_{OUT} = 0A$

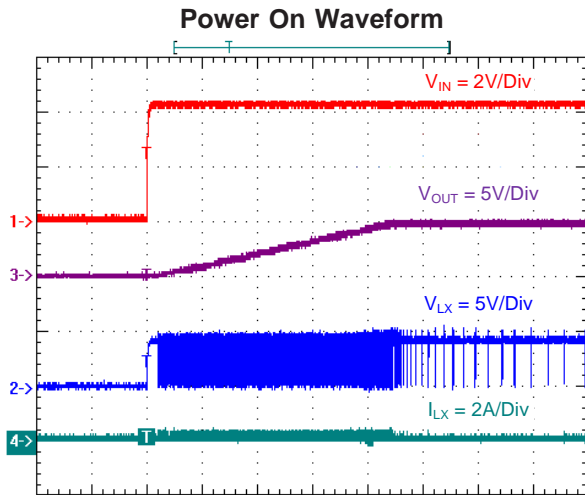

Time (2ms/Div)
 $V_{IN} = 4.2V, I_{OUT} = 0A$

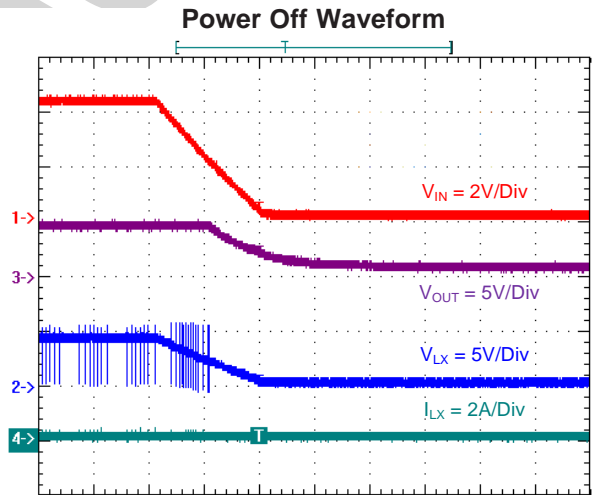

Time (20ms/Div)
 $V_{IN} = 4.2V, I_{OUT} = 0A$

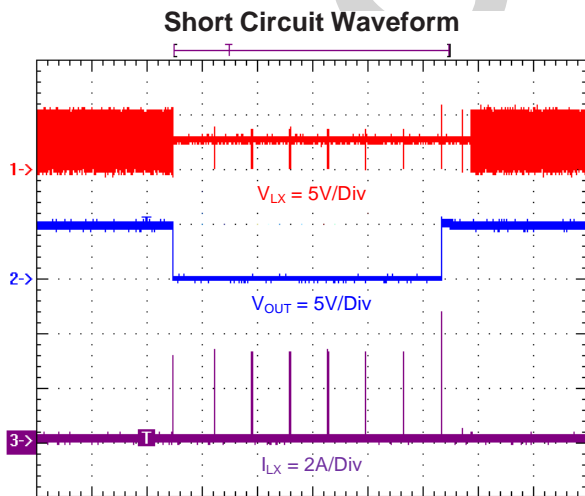

Time (100ms/Div)
 $V_{IN} = 2.5V$

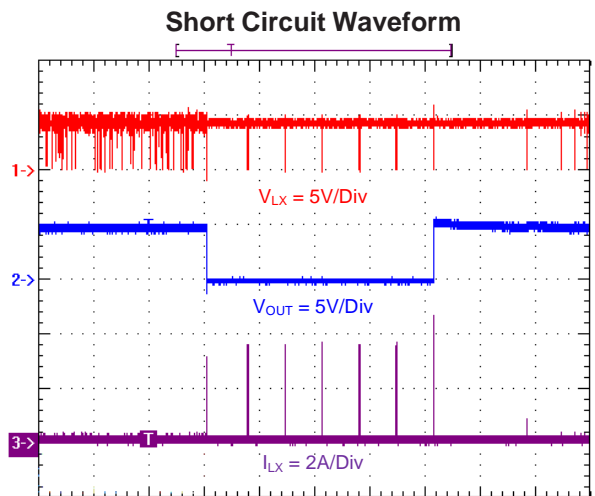

Time (100ms/Div)
 $V_{IN} = 4.2V$

Typical Operation Characteristics

200mA ~ 1.5A Load Transient Waveform

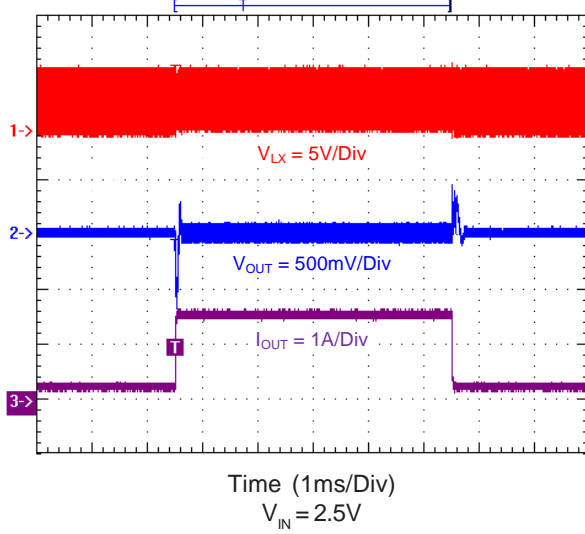

200mA ~ 1.5A Load Transient Waveform

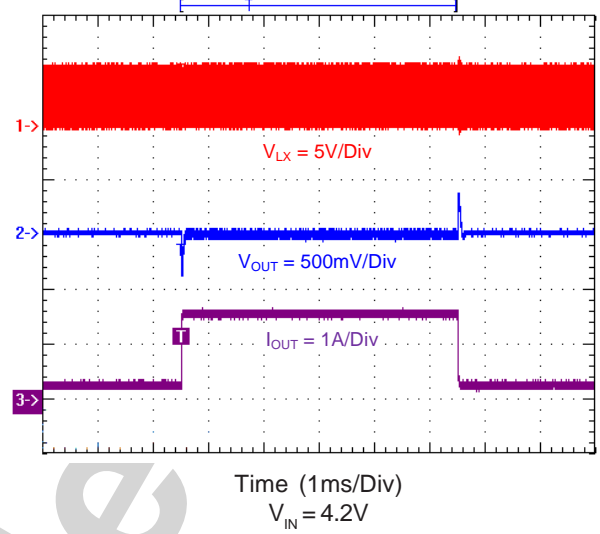

Efficiency vs. Load Current

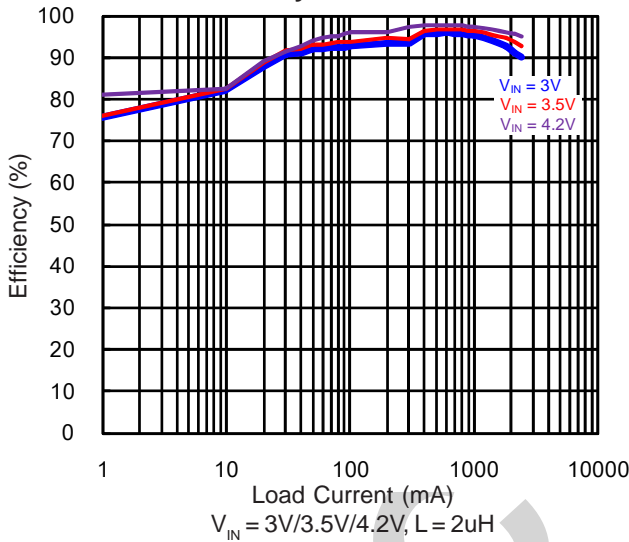

Line Regulation vs. Input Voltage

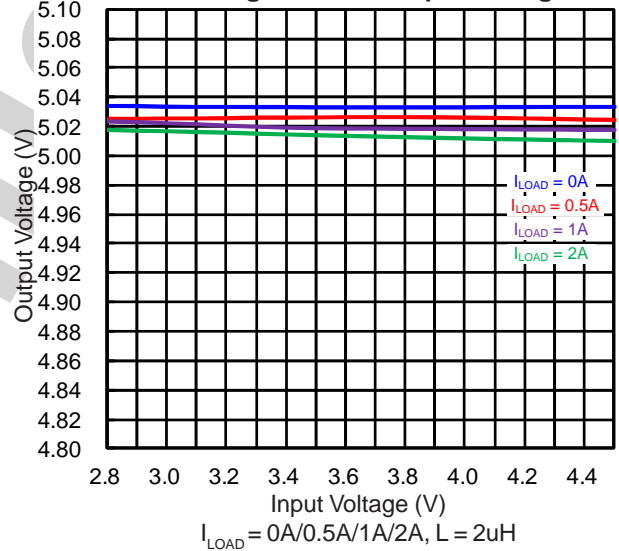

VFB vs. Temperature

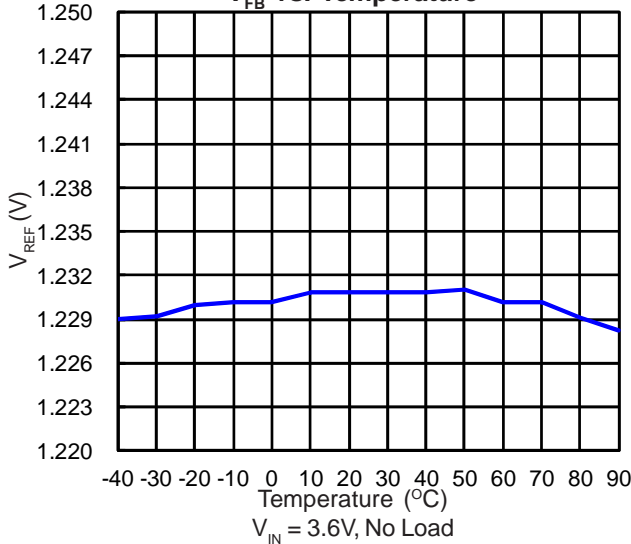

Switching Frequency vs. Temperature

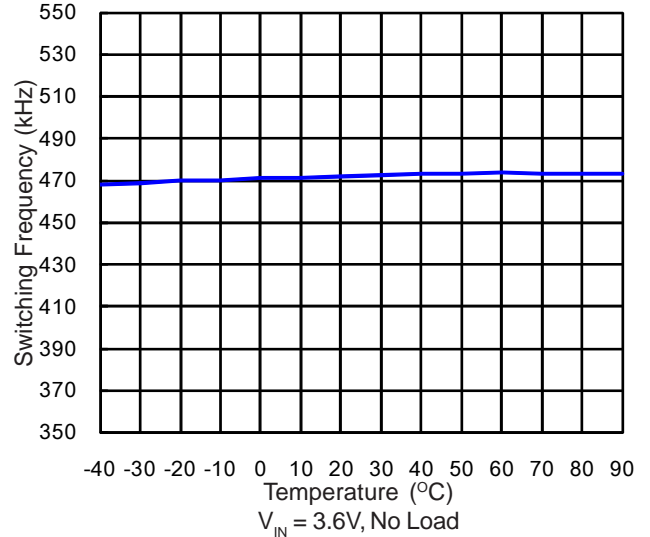

Typical Operation Characteristics

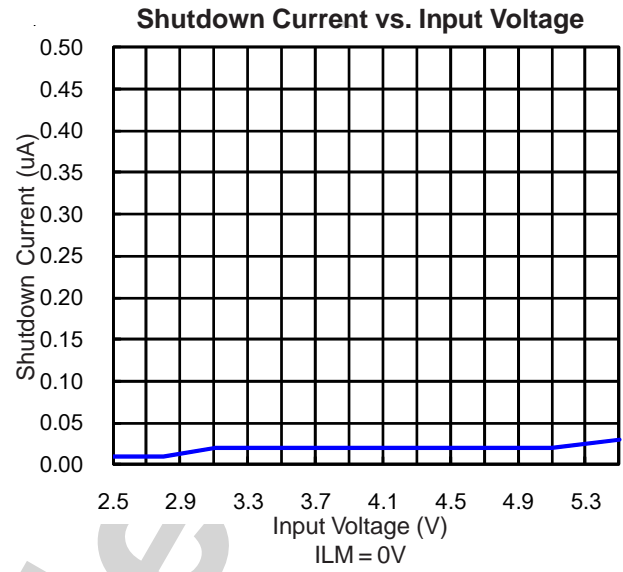
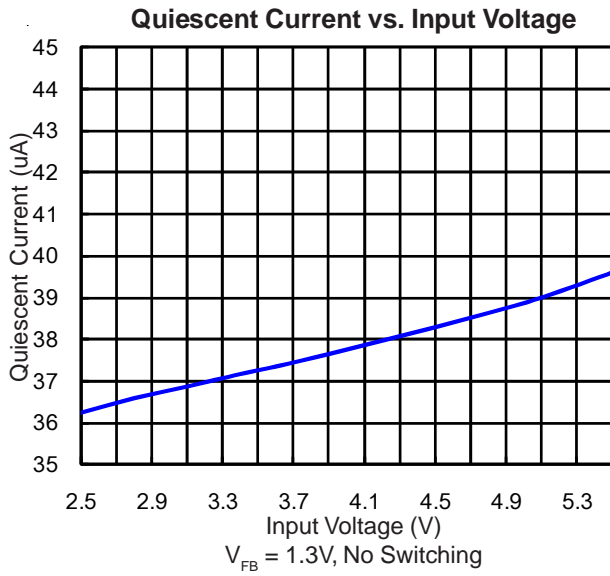

UPI Confidential

Application Information

Component Selection

External component selection begins with inductor value selection based on the considerations of the output voltage, output current, and the maximum/minimum input voltages.

Inductor Selection

Inductor selection should consider the inductor value, rated current, DCR, size, core material, and cost. The inductor value is selected based on the consideration of inductor ripple current and the inductor rated saturation current should be higher than the peak current at maximum load. The inductor should have low core loss at 500kHz and low DCR for better efficiency. Depending on the application, inductor values between 2uH and 2.2uH are recommended.

Capacitor Selection

For better voltage filtering, the low ESR of capacitor is recommended. It is recommended to use X5R or X7R type capacitor for the best performance.

Layout Consideration

For best performance of the uP6014, the following guidelines are recommended.

1. Input and output capacitors should be placed close to the IC and connected to ground plane to reduce noise coupling.
2. The GND should be connected to a strong ground plane for heat sinking and noise protection.
3. Keep the main current traces as short and wide as possible.
4. LX node of DC-DC converter is with high frequency voltage swing. It should be kept at a small area.
5. Please keep the V_{BAT} trace away from the noise source such as LX node and place C_{BAT} close to the IC and connected to ground plane to reduce noise coupling.
6. Place the feedback components as close as possible to the IC and keep away from the noisy devices.

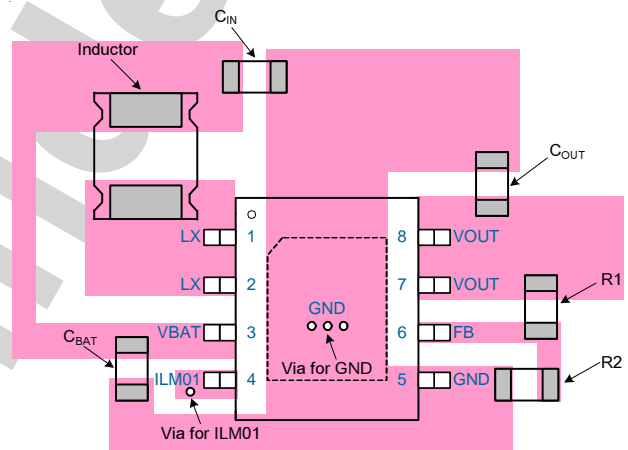
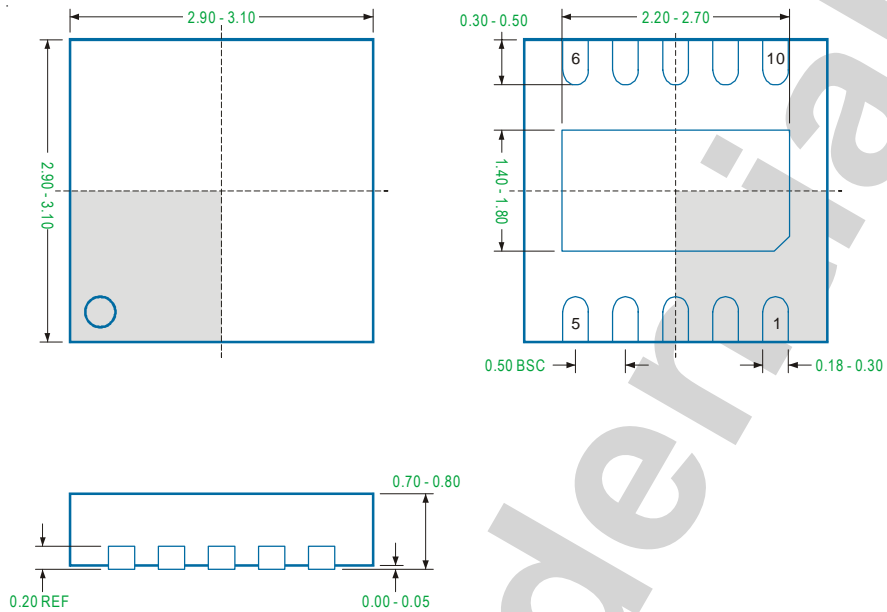

Figure 1. PSOP - 8L Layout Reference

WDFN3x3 - 10L



Note

1. Package Outline Unit Description:

BSC: Basic. Represents theoretical exact dimension or dimension target

MIN: Minimum dimension specified.

MAX: Maximum dimension specified.

REF: Reference. Represents dimension for reference use only. This value is not a device specification.

TYP: Typical. Provided as a general value. This value is not a device specification.

2. Dimensions in Millimeters.

3. Drawing not to scale.

4. These dimensions do not include mold flash or protrusions. Mold flash or protrusions shall not exceed 0.15mm.

PSOP - 8L

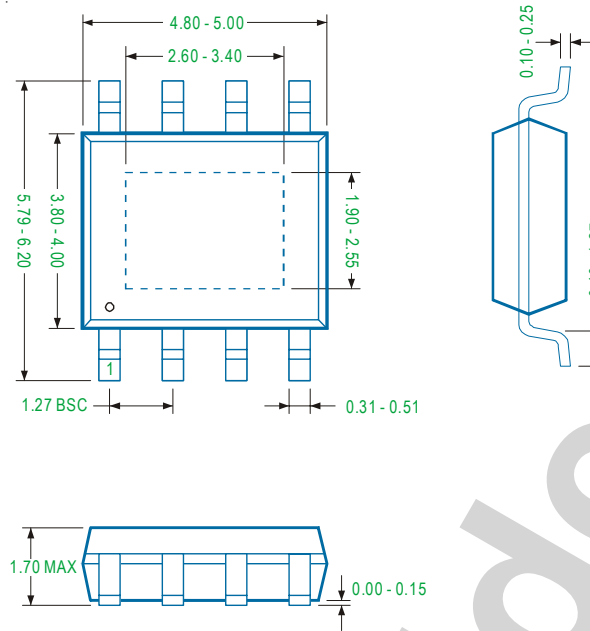

Note

1. Package Outline Unit Description:

BSC: Basic. Represents theoretical exact dimension or dimension target

MIN: Minimum dimension specified.

MAX: Maximum dimension specified.

REF: Reference. Represents dimension for reference use only. This value is not a device specification.

TYP: Typical. Provided as a general value. This value is not a device specification.

2. Dimensions in Millimeters.

3. Drawing not to scale.

4. These dimensions do not include mold flash or protrusions. Mold flash or protrusions shall not exceed 0.15mm.

Important Notice

uPI and its subsidiaries reserve the right to make corrections, modifications, enhancements, improvements, and other changes to its products and services at any time and to discontinue any product or service without notice. Customers should obtain the latest relevant information before placing orders and should verify that such information is current and complete.

uPI products are sold subject to the terms and conditions of sale supplied at the time of order acknowledgment. However, no responsibility is assumed by uPI or its subsidiaries for its use or application of any product or circuit; nor for any infringements of patents or other rights of third parties which may result from its use or application, including but not limited to any consequential or incidental damages. No uPI components are designed, intended or authorized for use in military, aerospace, automotive applications nor in systems for surgical implantation or life-sustaining. No license is granted by implication or otherwise under any patent or patent rights of uPI or its subsidiaries.

COPYRIGHT (c) 2015, UPI SEMICONDUCTOR CORP.

uPI Semiconductor Corp.

Headquarter
9F., No.5, Taiyuan 1st St. Zhubei City,
Hsinchu Taiwan, R.O.C.
TEL : 886.3.560.1666 FAX : 886.3.560.1888

Sales Branch Office
12F-5, No. 408, Ruiguang Rd. Neihu District,
Taipei Taiwan, R.O.C.
TEL : 886.2.8751.2062 FAX : 886.2.8751.5064