



Micro Commercial Components



Micro Commercial Components
20736 Marilla Street Chatsworth
CA 91311
Phone: (818) 701-4933
Fax: (818) 701-4939

2SC2881-O 2SC2881-Y

Features

- Lead Free Finish/RoHS Compliant ("P" Suffix designates RoHS Compliant. See ordering information)
- With SOT-89 package
- Power amplifier applications
- Epoxy meets UL 94 V-0 flammability rating
- Moisture Sensitivity Level 1
- Halogen free available upon request by adding suffix "-HF"

Maximum Ratings

Symbol	Rating	Rating	Unit
V _{CEO}	Collector-Emitter Voltage	120	V
V _{CBO}	Collector-Base Voltage	120	V
V _{EBO}	Emitter-Base Voltage	5.0	V
I _C	Collector Current	800	mA
I _B	Base Current	160	mA
P _C	Collector power dissipation	500 1000(Note 1)	mW
T _J	Junction Temperature	150	°C
T _{STG}	Storage Temperature	-55 to +150	°C

Note 1: Mounted on ceramic substrate (250mm² x 0.8t)

Electrical Characteristics @ 25°C Unless Otherwise Specified

Symbol	Parameter	Min	Typ.	Max	Units
--------	-----------	-----	------	-----	-------

OFF CHARACTERISTICS

V _{(BR)CEO}	Collector-Emitter Breakdown Voltage* (I _C =10mA, I _B =0)	120	---	---	Vdc
V _{(BR)EBO}	Collector-Emitter Breakdown Voltage* (I _E =1mA, I _C =0)	5	---	---	Vdc
I _{CBO}	Collector-Base Cutoff Current (V _{CB} =120Vdc, I _E =0)	---	---	0.1	uA
I _{EBO}	Emitter-Base Cutoff Current (V _{EB} =5.0Vdc, I _C =0)	---	---	0.1	uA

ON CHARACTERISTICS

h _{FE}	Forward Current Transfer ratio (I _C =0.1A, V _{CE} =5.0Vdc)	80	---	240	---
V _{CE(sat)}	Collector-Emitter Saturation Voltage (I _C =0.5A, I _B =50mA)	---	---	1.0	Vdc
V _{BE}	Base-Emitter Voltage (I _C =0.5A, V _{CE} =5.0Vdc)	---	---	1.0	Vdc
f _T	Transition Frequency (I _C =0.1A, V _{CE} =5.0Vdc)	---	120	---	MHz
C _{ob}	Collector Output Capacitance (V _{CB} =10V, I _E =0, f=1MHz)	---	---	30	pF

CLASSIFICATION OF H_{FE}

Rank	O	Y
Range	80-160	120-240
Marking	CO1	CY1

NPN Silicon Power Transistors

SOT-89

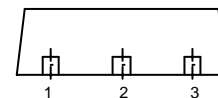
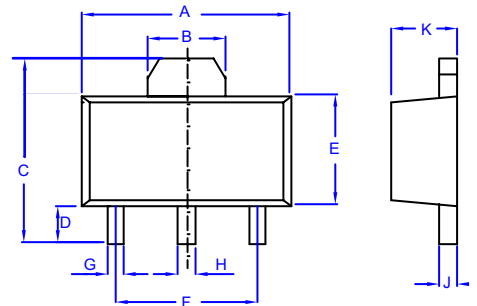

- 1.BASE
- 2.COLLECTOR
- 3.EMITTER

DIM	DIMENSINS				NOTES
	INCHES		MM		
	MIN	MAX	MIN	MAX	
A	.173	.181	4.39	4.60	
B	.063	.071	1.60	1.80	
C	.154	.165	3.91	4.25	
D	.031	.039	0.80	1.00	
E	.092	.100	2.34	2.54	
F	.118	----	3.00	----	TYP
G	.013	.019	0.33	0.48	
H	.015	.021	0.38	0.53	
J	.015	.016	0.38	0.41	
K	.055	.063	1.40	1.60	

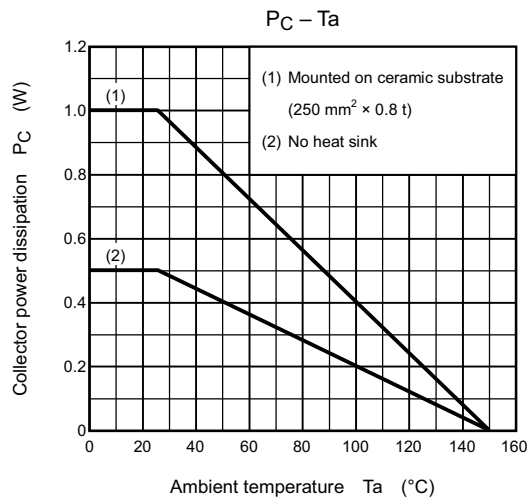
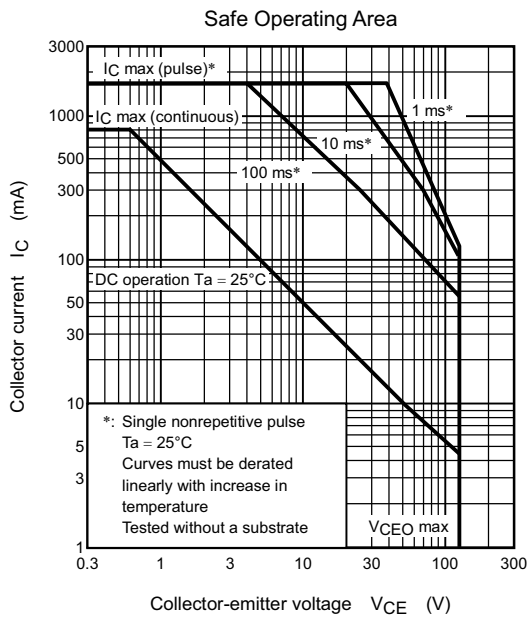
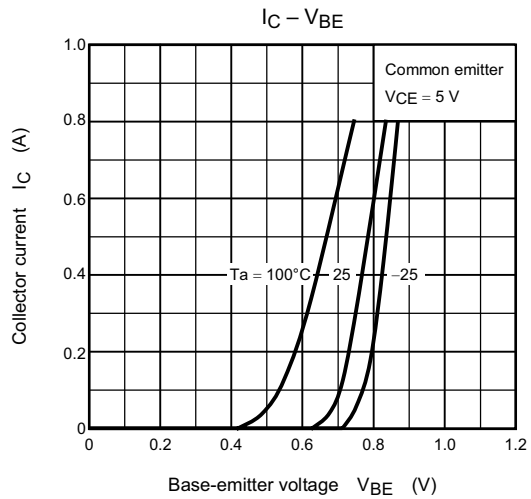
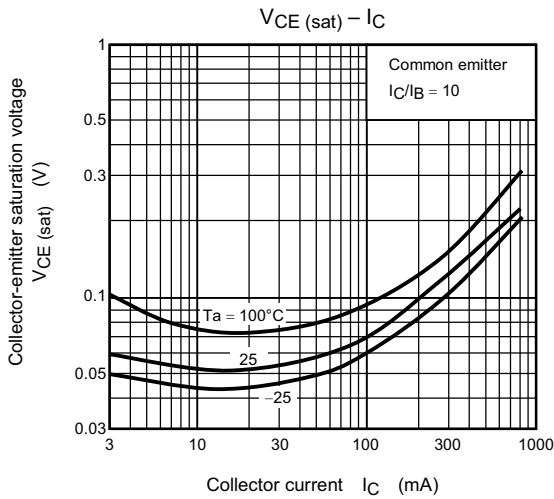
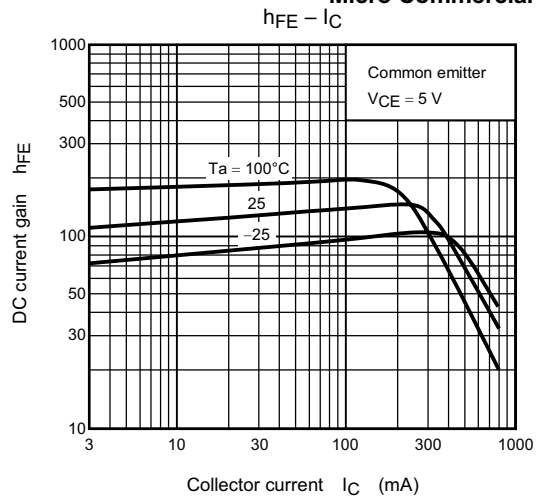
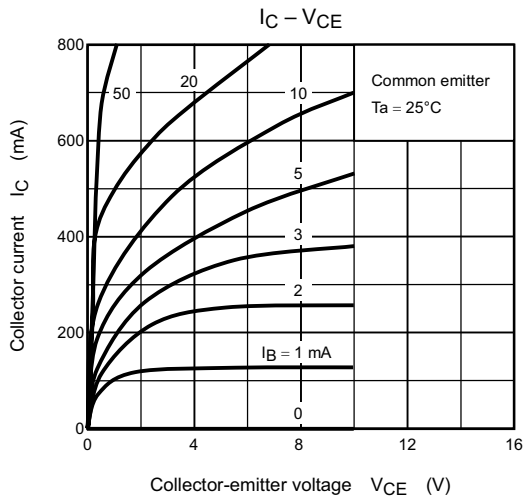



Micro Commercial Components

Ordering Information :

Device	Packing
Part Number-TP	Tape&Reel; 1Kpcs/Reel

Note : Adding "-HF" suffix for halogen free, eg. Part Number-TP-HF

IMPORTANT NOTICE

Micro Commercial Components Corp. reserves the right to make changes without further notice to any product herein to make corrections, modifications, enhancements, improvements, or other changes. **Micro Commercial Components Corp.** does not assume any liability arising out of the application or use of any product described herein; neither does it convey any license under its patent rights, nor the rights of others. The user of products in such applications shall assume all risks of such use and will agree to hold **Micro Commercial Components Corp.** and all the companies whose products are represented on our website, harmless against all damages.

LIFE SUPPORT

MCC's products are not authorized for use as critical components in life support devices or systems without the express written approval of Micro Commercial Components Corporation.

CUSTOMER AWARENESS

Counterfeiting of semiconductor parts is a growing problem in the industry. Micro Commercial Components (MCC) is taking strong measures to protect ourselves and our customers from the proliferation of counterfeit parts. MCC strongly encourages customers to purchase MCC parts either directly from MCC or from Authorized MCC Distributors who are listed by country on our web page cited below. Products customers buy either from MCC directly or from Authorized MCC Distributors are genuine parts, have full traceability, meet MCC's quality standards for handling and storage. **MCC will not provide any warranty coverage or other assistance for parts bought from Unauthorized Sources.** MCC is committed to combat this global problem and encourage our customers to do their part in stopping this practice by buying direct or from authorized distributors.

www.mccsemi.com