

NCV8501 Series

Micropower 150 mA LDO Linear Regulators with ENABLE, DELAY, RESET, and Monitor FLAG

The NCV8501 is a family of precision micropower voltage regulators. Their output current capability is 150 mA. The family has output voltage options for adjustable, 2.5 V, 3.3 V, 5.0 V, 8.0 V, and 10 V.

The output voltage is accurate within $\pm 2.0\%$ with a maximum dropout voltage of 0.6 V at 150 mA. Low quiescent current is a feature drawing only 90 μA with a 100 μA load. This part is ideal for any and all battery operated microprocessor equipment.

Microprocessor control logic includes an active $\overline{\text{RESET}}$ (with DELAY), and a FLAG monitor which can be used to provide an early warning signal to the microprocessor of a potential impending $\overline{\text{RESET}}$ signal. The use of the FLAG monitor allows the microprocessor to finish any signal processing before the $\overline{\text{RESET}}$ shuts the microprocessor down.

The active $\overline{\text{RESET}}$ circuit operates correctly at an output voltage as low as 1.0 V. The $\overline{\text{RESET}}$ function is activated during the power up sequence or during normal operation if the output voltage drops outside the regulation limits.

The regulator is protected against reverse battery, short circuit, and thermal overload conditions. The device can withstand load dump transients making it suitable for use in automotive environments. The device has also been optimized for EMC conditions.

Features

- Output Voltage Options: Adjustable, 2.5 V, 3.3 V, 5.0 V, 8.0 V, 10 V
- $\pm 2.0\%$ Output
- Low 90 μA Quiescent Current
- Fixed or Adjustable Output Voltage
- Active $\overline{\text{RESET}}$
- ENABLE
- 150 mA Output Current Capability
- Fault Protection
 - ◆ +60 V Peak Transient Voltage
 - ◆ -15 V Reverse Voltage
 - ◆ Short Circuit
 - ◆ Thermal Overload
- Early Warning through $\overline{\text{FLAG/MON}}$ Leads
- NCV Prefix for Automotive and Other Applications Requiring Site and Change Control
- Pb-Free Packages are Available



ON Semiconductor®

<http://onsemi.com>



SO-8
D SUFFIX
CASE 751

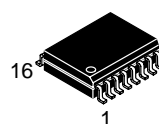

SOIC 16 LEAD
WIDE BODY
EXPOSED PAD
PDW SUFFIX
CASE 751R

MARKING DIAGRAMS

SO-8

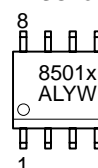

SOW-16
E PAD

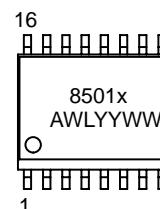

- x = Voltage Ratings as Indicated Below:
- A = Adjustable
 - 2 = 2.5 V
 - 3 = 3.3 V
 - 5 = 5.0 V
 - 8 = 8.0 V
 - 1 = 10 V
- A = Assembly Location
WL, L = Wafer Lot
YY, Y = Year
WW, W = Work Week

ORDERING INFORMATION

See detailed ordering and shipping information in the package dimensions section on page 13 of this data sheet.

NCV8501 Series

PIN CONNECTIONS, ADJUSTABLE OUTPUT

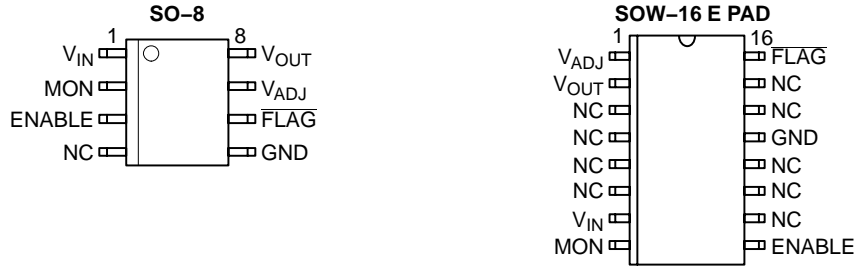

PIN CONNECTIONS, FIXED OUTPUT

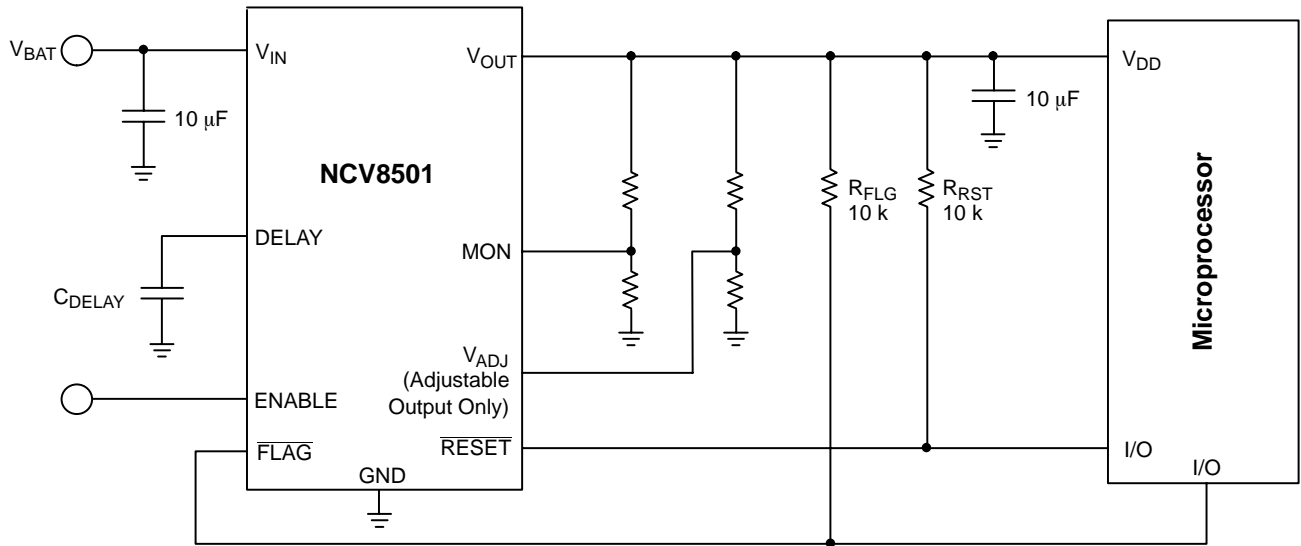
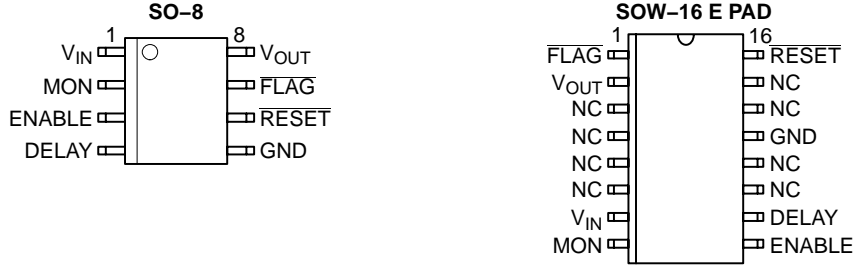

Figure 1. Application Diagram

NCV8501 Series

MAXIMUM RATINGS*

Rating	Value	Unit
V_{IN} (dc)	-15 to 45	V
Peak Transient Voltage (46 V Load Dump @ $V_{IN} = 14$ V)	60	V
Operating Voltage	45	V
V_{OUT} (dc)	16	V
Voltage Range (\overline{RESET} , \overline{FLAG})	-0.3 to 10	V
Input Voltage Range (MON)	-0.3 to 10	V
Input Voltage Range (ENABLE)	-0.3 to 10**	V
ESD Susceptibility (Human Body Model)	2.0	kV
Junction Temperature, T_J	-40 to +150	°C
Storage Temperature, T_S	-55 to 150	°C
Package Thermal Resistance, SO-8:	Junction-to-Case, $R_{\theta JC}$ Junction-to-Ambient, $R_{\theta JA}$	45 165 °C/W °C/W
Package Thermal Resistance, SOW-16 E PAD:	Junction-to-Case, $R_{\theta JC}$ Junction-to-Ambient, $R_{\theta JA}$ Junction-to-Pin, $R_{\theta JP}$ (Note 1)	15 56 35 °C/W °C/W °C/W
Lead Temperature Soldering:	Reflow: (SMD styles only) (Note 2)	240 peak 260 Peak (Pb-Free) (Note 3) °C

Maximum ratings are those values beyond which device damage can occur. Maximum ratings applied to the device are individual stress limit values (not normal operating conditions) and are not valid simultaneously. If these limits are exceeded, device functional operation is not implied, damage may occur and reliability may be affected.

*During the voltage range which exceeds the maximum tested voltage of V_{IN} , operation is assured, but not specified. Wider limits may apply. Thermal dissipation must be observed closely.

**Reference Figure 14 for switched-battery ENABLE application.

1. Measured to pin 16.
2. 150 second maximum above 183°C, Pb-Free – 150 second maximum above 217°C.
3. -5°C / +0°C allowable conditions, applies to both Pb and Pb-Free devices.

NCV8501 Series

ELECTRICAL CHARACTERISTICS ($I_{OUT} = 1.0 \text{ mA}$, $ENABLE = 5.0 \text{ V}$, $-40^{\circ}\text{C} \leq T_J \leq 125^{\circ}\text{C}$; V_{IN} dependent on voltage option (Note 4); unless otherwise specified.)

Characteristic	Test Conditions	Min	Typ	Max	Unit
Output Stage					
Output Voltage for 2.5 V Option	$6.5 \text{ V} < V_{IN} < 16 \text{ V}$, $100 \mu\text{A} \leq I_{OUT} \leq 150 \text{ mA}$	2.450	2.5	2.550	V
	$5.5 \text{ V} < V_{IN} < 26 \text{ V}$, $100 \mu\text{A} \leq I_{OUT} \leq 150 \text{ mA}$	2.425	2.5	2.575	V
Output Voltage for 3.3 V Option	$7.3 \text{ V} < V_{IN} < 16 \text{ V}$, $100 \mu\text{A} \leq I_{OUT} \leq 150 \text{ mA}$	3.234	3.3	3.366	V
	$5.5 \text{ V} < V_{IN} < 26 \text{ V}$, $100 \mu\text{A} \leq I_{OUT} \leq 150 \text{ mA}$	3.201	3.3	3.399	V
Output Voltage for 5.0 V Option	$9.0 \text{ V} < V_{IN} < 16 \text{ V}$, $100 \mu\text{A} \leq I_{OUT} \leq 150 \text{ mA}$	4.90	5.0	5.10	V
	$6.0 \text{ V} < V_{IN} < 26 \text{ V}$, $100 \mu\text{A} \leq I_{OUT} \leq 150 \text{ mA}$	4.85	5.0	5.15	V
Output Voltage for 8.0 V Option	$9.0 \text{ V} < V_{IN} < 26 \text{ V}$, $100 \mu\text{A} \leq I_{OUT} \leq 150 \text{ mA}$	7.76	8.0	8.24	V
Output Voltage for 10 V Option	$11 \text{ V} < V_{IN} < 26 \text{ V}$, $100 \mu\text{A} \leq I_{OUT} \leq 150 \text{ mA}$	9.7	10	10.3	V
Output Voltage for Adjustable Option	$V_{OUT} = V_{ADJ}$ (Unity Gain)				
	$6.5 \text{ V} < V_{IN} < 16 \text{ V}$, $100 \mu\text{A} < I_{OUT} < 150 \text{ mA}$ $5.5 \text{ V} < V_{IN} < 26 \text{ V}$, $100 \mu\text{A} < I_{OUT} < 150 \text{ mA}$	1.254 1.242	1.280 1.280	1.306 1.318	V V
Dropout Voltage ($V_{IN} - V_{OUT}$) (5.0 V, 8.0 V, 10 V, and Adj. > 5.0 V Options Only)	$I_{OUT} = 150 \text{ mA}$	–	400	600	mV
	$I_{OUT} = 1.0 \text{ mA}$	–	100	150	mV
Load Regulation	$V_{IN} = 14 \text{ V}$, $5.0 \text{ mA} \leq I_{OUT} \leq 150 \text{ mA}$	–30	5.0	30	mV
Line Regulation	$[V_{OUT}(\text{Typ}) + 1.0] < V_{IN} < 26 \text{ V}$, $I_{OUT} = 1.0 \text{ mA}$	–	15	60	mV
Quiescent Current, Low Load 2.5 V Option 3.3 V Option 5.0 V Option 8.0 V Option 10 V Option Adjustable Option	$I_{OUT} = 100 \mu\text{A}$, $V_{IN} = 12 \text{ V}$, $MON = V_{OUT}$	–	90	125	μA
	–	–	90	125	μA
	–	–	90	125	μA
	–	–	100	150	μA
	–	–	100	150	μA
	–	–	100	150	μA
	–	–	50	75	μA
Quiescent Current, Medium Load All Options	$I_{OUT} = 75 \text{ mA}$, $V_{IN} = 14 \text{ V}$, $MON = V_{OUT}$	–	4.0	6.0	mA
Quiescent Current, High Load All Options	$I_{OUT} = 150 \text{ mA}$, $V_{IN} = 14 \text{ V}$, $MON = V_{OUT}$	–	12	19	mA
Quiescent Current, (I_Q) Sleep Mode	$ENABLE = 0 \text{ V}$, $V_{IN} = 12 \text{ V}$	–	12	30	μA
Current Limit	–	151	300	–	mA
Short Circuit Output Current	$V_{OUT} = 0 \text{ V}$	40	190	–	mA
Thermal Shutdown	(Guaranteed by Design)	150	180	–	$^{\circ}\text{C}$

Reset Function (RESET)

RESET Threshold for 2.5 V Option HIGH (V_{RH}) LOW (V_{RL})	$5.5 \text{ V} \leq V_{IN} \leq 26 \text{ V}$ (Note 5) V_{OUT} Increasing	2.28	2.350	$0.98 \times V_{OUT}$	V
	V_{OUT} Decreasing	2.25	2.300	$0.97 \times V_{OUT}$	V
RESET Threshold for 3.3 V Option HIGH (V_{RH}) LOW (V_{RL})	$5.5 \text{ V} \leq V_{IN} \leq 26 \text{ V}$ (Note 5) V_{OUT} Increasing	3.00	3.102	$0.98 \times V_{OUT}$	V
	V_{OUT} Decreasing	2.97	3.036	$0.97 \times V_{OUT}$	V
RESET Threshold for 5.0 V Option HIGH (V_{RH}) LOW (V_{RL})	V_{OUT} Increasing	4.55	4.70	$0.98 \times V_{OUT}$	V
	V_{OUT} Decreasing	4.50	4.60	$0.97 \times V_{OUT}$	V

4. Voltage range specified in the Output Stage of the Electrical Characteristics in boldface type.

5. For $V_{IN} \leq 5.5 \text{ V}$, a RESET = Low may occur with the output in regulation.

NCV8501 Series

ELECTRICAL CHARACTERISTICS ($I_{OUT} = 1.0 \text{ mA}$, $ENABLE = 5.0 \text{ V}$, $-40^{\circ}\text{C} \leq T_J \leq 125^{\circ}\text{C}$; V_{IN} dependent on voltage option (Note 4); unless otherwise specified.)

Characteristic	Test Conditions	Min	Typ	Max	Unit
Reset Function (RESET)					
RESET Threshold for 8.0 V Option HIGH (V_{RH}) LOW (V_{RL})	V_{OUT} Increasing V_{OUT} Decreasing	6.86 6.80	7.52 7.36	$0.98 \times V_{OUT}$ $0.97 \times V_{OUT}$	V V
RESET Threshold for 10 V Option HIGH (V_{RH}) LOW (V_{RL})	V_{OUT} Increasing V_{OUT} Decreasing	8.60 8.50	9.40 9.20	$0.98 \times V_{OUT}$ $0.97 \times V_{OUT}$	V V
Output Voltage Low (V_{RLO})	$1.0 \text{ V} \leq V_{OUT} \leq V_{RL}$, $R_{RESET} = 10 \text{ k}$	–	0.1	0.4	V
DELAY Switching Threshold (V_{DT})	–	1.4	1.8	2.2	V
DELAY Low Voltage	$V_{OUT} < \overline{RESET}$ Threshold Low(min)	–	–	0.1	V
DELAY Charge Current	DELAY = 1.0 V, $V_{OUT} > V_{RH}$	1.5	2.5	3.5	μA
DELAY Discharge Current	DELAY = 1.0 V, $V_{OUT} = 1.5 \text{ V}$	5.0	–	–	mA

FLAG/Monitor

Monitor Threshold	Increasing and Decreasing	1.10	1.20	1.31	V
Hysteresis	–	20	50	100	mV
Input Current	MON = 2.0 V	–0.5	0.1	0.5	μA
Output Saturation Voltage	MON = 0 V, $I_{FLAG} = 1.0 \text{ mA}$	–	0.1	0.4	V

Voltage Adjust (Adjustable Output only)

Input Current	$V_{ADJ} = 1.28 \text{ V}$	–0.5	–	0.5	μA
---------------	----------------------------	------	---	-----	---------------

ENABLE

Input Threshold	Low High	– 3.0	– –	0.5 –	V V
Input Current	ENABLE = 5.0 V	–	1.0	5.0	μA

4. Voltage range specified in the Output Stage of the Electrical Characteristics in boldface type.
5. For $V_{IN} \leq 5.5 \text{ V}$, a RESET = Low may occur with the output in regulation.

NCV8501 Series

PACKAGE PIN DESCRIPTION, ADJUSTABLE OUTPUT

Package Pin Number		Pin Symbol	Function
SO-8	SOW-16 E PAD		
1	7	V _{IN}	Input Voltage.
2	8	MON	Monitor. Input for early warning comparator. If not needed connect to V _{OUT} .
3	9	ENABLE	ENABLE control for the IC. A high powers the device up.
4	3-6, 10-12, 14, 15	NC	No connection.
5	13	GND	Ground. All GND leads must be connected to Ground.
6	16	FLAG	Open collector output from early warning comparator.
7	1	V _{ADJ}	Voltage Adjust. A resistor divider from V _{OUT} to this lead sets the output voltage.
8	2	V _{OUT}	±2.0%, 150 mA output.

PACKAGE PIN DESCRIPTION, FIXED OUTPUT

Package Pin Number		Pin Symbol	Function
SO-8	SOW-16 E PAD		
1	7	V _{IN}	Input Voltage.
2	8	MON	Monitor. Input for early warning comparator. If not needed connect to V _{OUT} .
3	9	ENABLE	ENABLE control for the IC. A high powers the device up.
4	10	DELAY	Timing capacitor for RESET function.
5	13	GND	Ground. All GND leads must be connected to Ground.
6	16	RESET	Active reset (accurate to V _{OUT} ≥ 1.0 V)
7	1	FLAG	Open collector output from early warning comparator.
8	2	V _{OUT}	±2.0%, 150 mA output.
-	3-6, 11, 12, 14, 15	NC	No connection.

TYPICAL PERFORMANCE CHARACTERISTICS

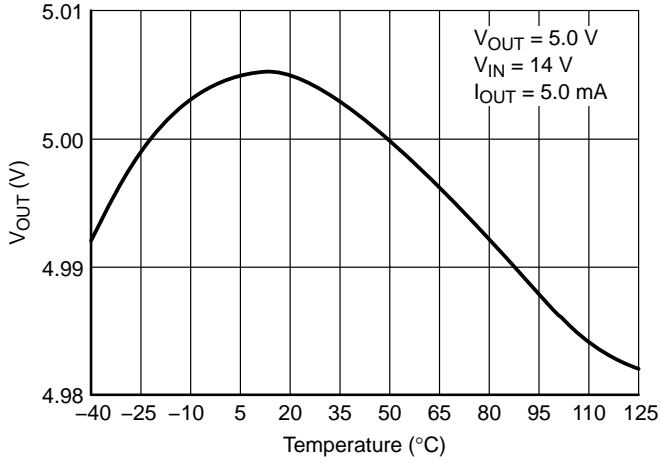

Figure 2. Output Voltage vs. Temperature

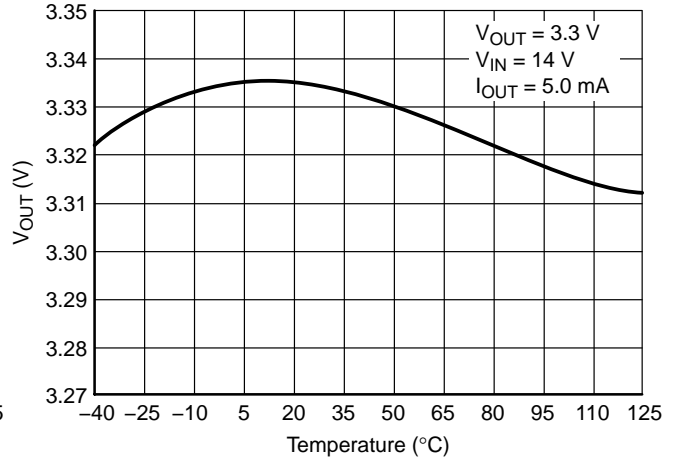

Figure 3. Output Voltage vs. Temperature

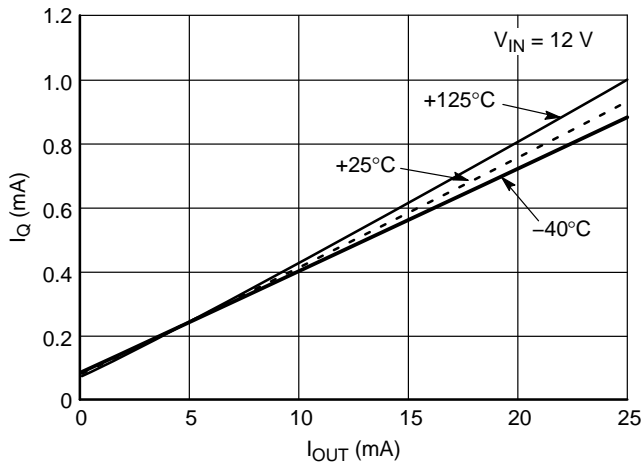

Figure 4. Quiescent Current vs. Output Current

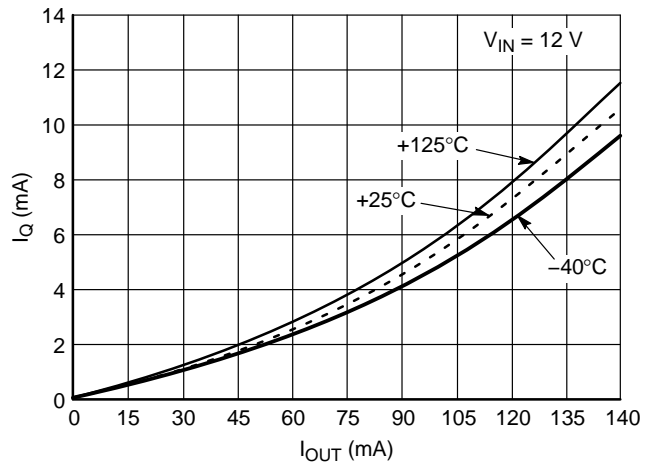

Figure 5. Quiescent Current vs. Output Current

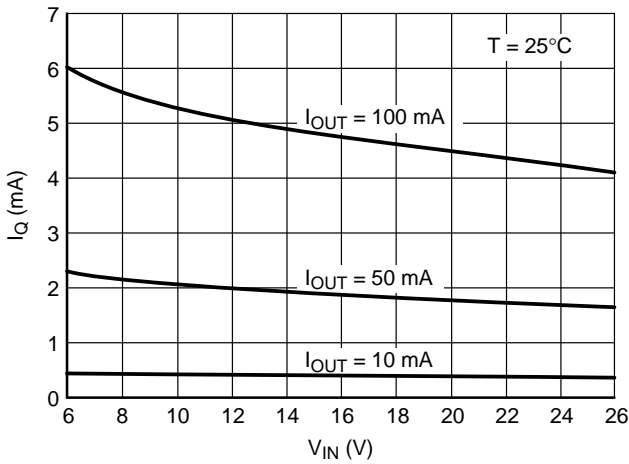

Figure 6. Quiescent Current vs. Input Voltage

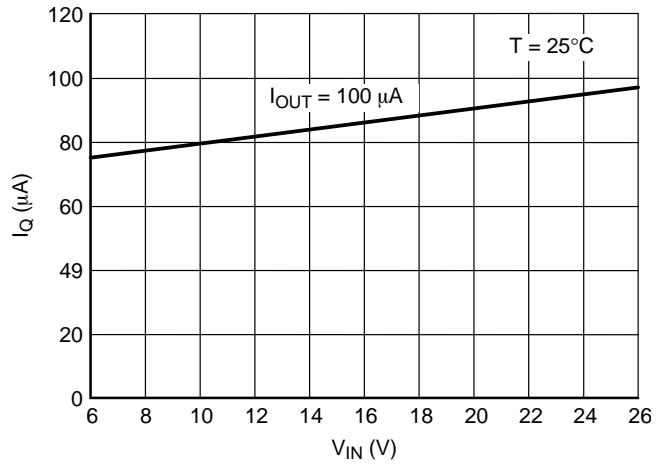

Figure 7. Quiescent Current vs. Input Voltage

TYPICAL PERFORMANCE CHARACTERISTICS

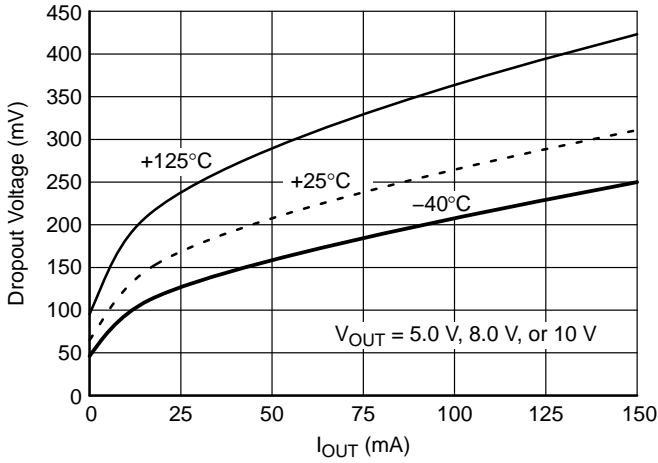

Figure 8. Dropout Voltage vs. Output Current

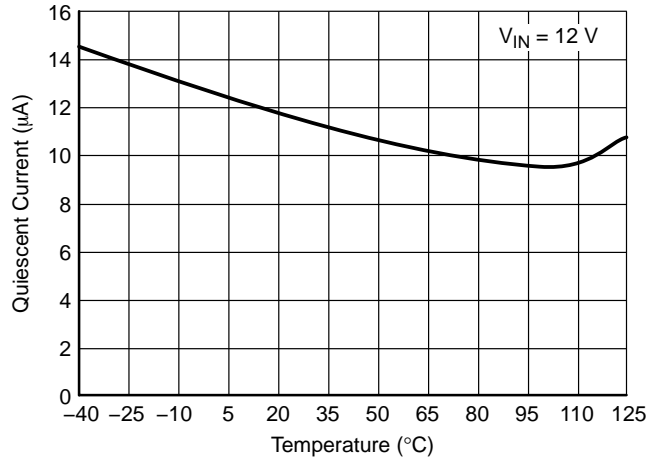

Figure 9. Sleep Mode I_Q vs. Temperature

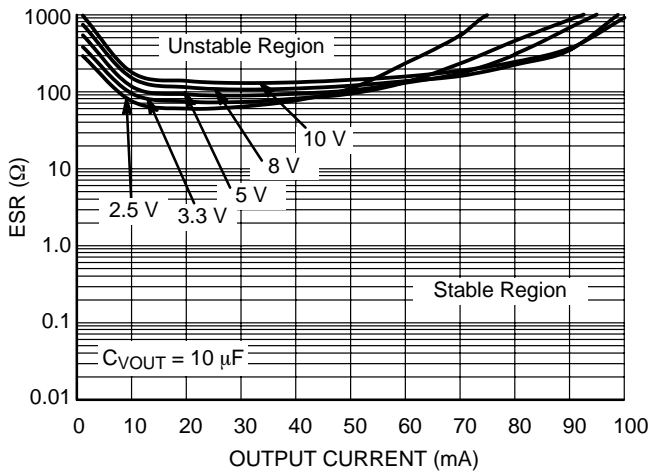

Figure 10. Output Stability with Output Voltage Change

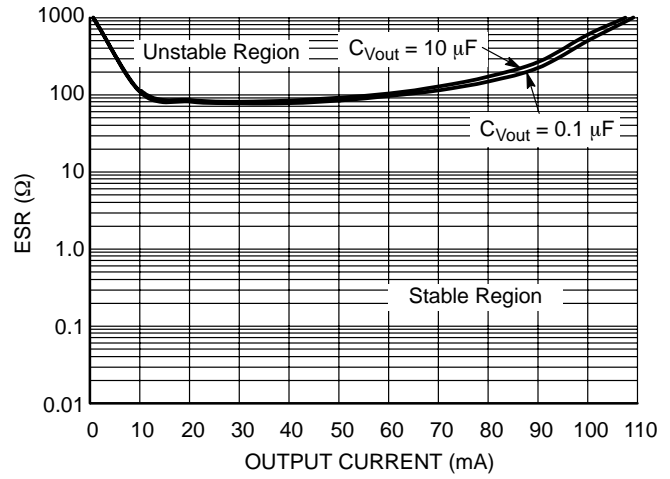

Figure 11. Output Stability with Output Capacitor Change

NCV8501 Series

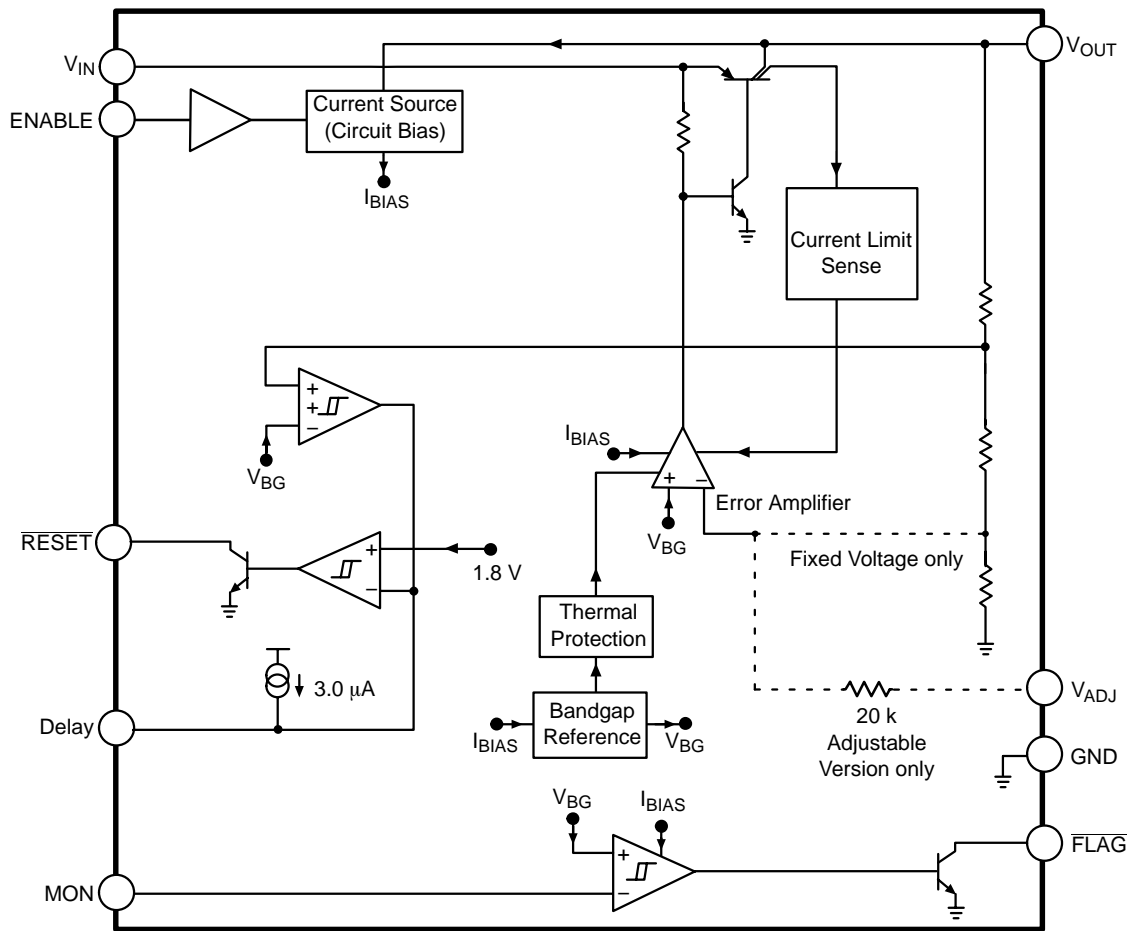

Figure 12. Block Diagram

CIRCUIT DESCRIPTION

REGULATOR CONTROL FUNCTIONS

The NCV8501 contains the microprocessor compatible control function $\overline{\text{RESET}}$ (Figure 13).

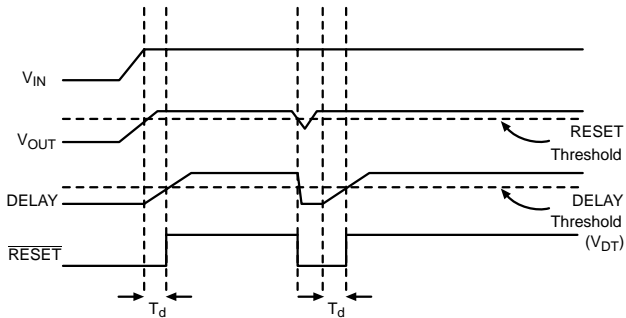

Figure 13. Reset and Delay Circuit Wave Forms

$\overline{\text{RESET}}$ Function

A $\overline{\text{RESET}}$ signal (low voltage) is generated as the IC powers up until V_{OUT} is within 6.0% of the regulated output voltage, or when V_{OUT} drops out of regulation, and is lower than 8.0% below the regulated output voltage. Hysteresis is included in the function to minimize oscillations.

The $\overline{\text{RESET}}$ output is an open collector NPN transistor, controlled by a low voltage detection circuit. The circuit is functionally independent of the rest of the IC thereby guaranteeing that the $\overline{\text{RESET}}$ signal is valid for V_{OUT} as low as 1.0 V.

ENABLE Function

The part stays in a low I_{Q} sleep mode when the ENABLE pin is held low. The part has an internal pull down if the pin is left floating. This is intended for failure modes only. An external connection (active pulldown, resistor, or switch) for normal operation is recommended.

The integrity of the ENABLE pin allows it to be tied directly to the battery line through an external resistor. It will withstand load dump potentials in this configuration.

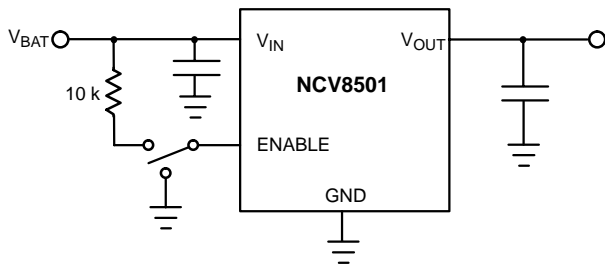

Figure 14. ENABLE Function

DELAY Function

The reset delay circuit provides a programmable (by external capacitor) delay on the $\overline{\text{RESET}}$ output lead.

The DELAY lead provides source current (typically 2.5 μA) to the external DELAY capacitor during the following proceedings:

1. During Power Up (once the regulation threshold has been verified).
2. After a reset event has occurred and the device is back in regulation. The DELAY capacitor is discharged when the regulation ($\overline{\text{RESET}}$ threshold) has been violated. This is a latched incident. The capacitor will fully discharge and wait for the device to regulate before going through the delay time event again.

$\overline{\text{FLAG}}$ /Monitor Function

An on-chip comparator is provided to perform an early warning to the microprocessor of a possible reset signal. The reset signal typically turns the microprocessor off instantaneously. This can cause unpredictable results with the microprocessor. The signal received from the $\overline{\text{FLAG}}$ pin will allow the microprocessor time to complete its present task before shutting down. This function is performed by a comparator referenced to the bandgap reference. The actual trip point can be programmed externally using a resistor divider to the input monitor (MON) (Figure 15). The typical threshold is 1.20 V on the MON pin.

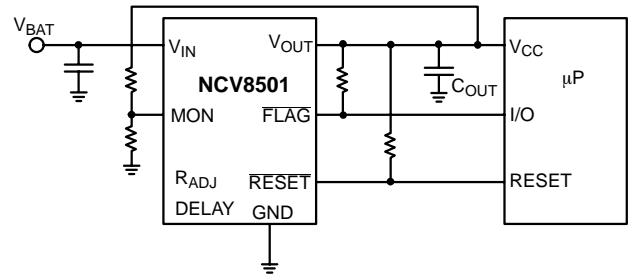

Figure 15. $\overline{\text{FLAG}}$ /Monitor Function

Voltage Adjust

Figure 16 shows the device setup for a user configurable output voltage. The feedback to the V_{ADJ} pin is taken from a voltage divider referenced to the output voltage. The loop is balanced around the Unity Gain threshold (1.28 V typical).

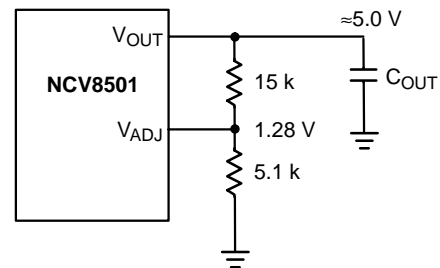

Figure 16. Adjustable Output Voltage

APPLICATION NOTES

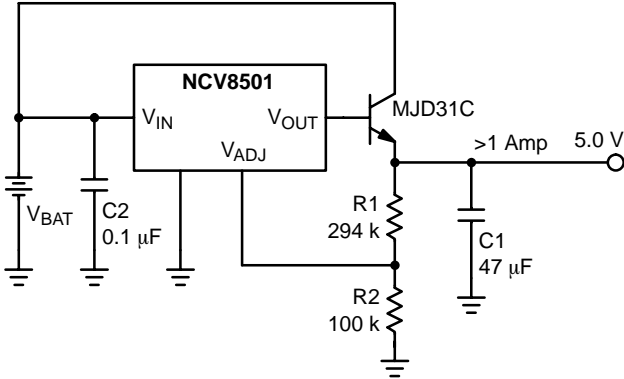

Figure 17. Additional Output Current

Adding Capability

Figure 17 shows how the adjustable version of parts can be used with an external pass transistor for additional current capability. The setup as shown will provide greater than 1 Amp of output current.

FLAG MONITOR

Figure 18 shows the FLAG Monitor waveforms as a result of the circuit depicted in Figure 15. As the output voltage falls (V_{OUT}), the Monitor threshold is crossed. This causes the voltage on the \overline{FLAG} output to go low sending a warning signal to the microprocessor that a \overline{RESET} signal may occur in a short period of time. $T_{WARNING}$ is the time the microprocessor has to complete the function it is currently working on and get ready for the \overline{RESET} shutdown signal.

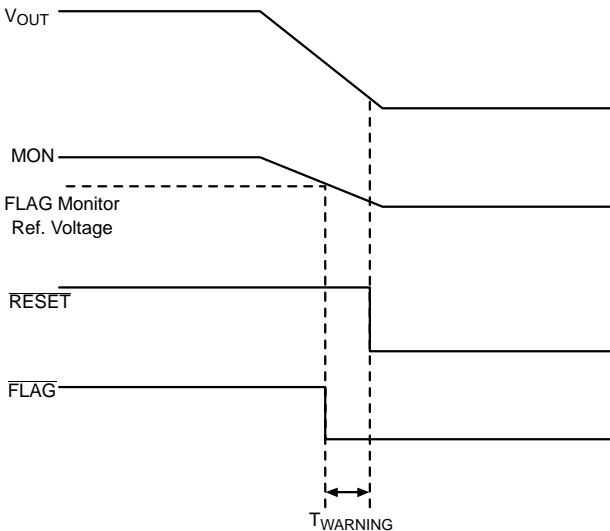
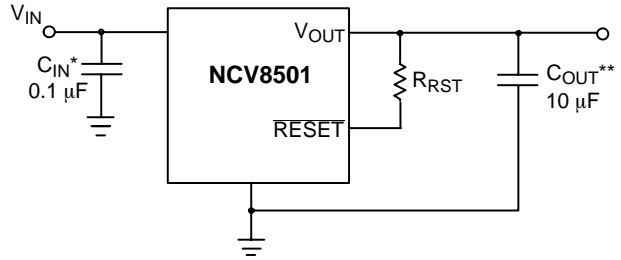

Figure 18. FLAG Monitor Circuit Waveform



* C_{IN} required if regulator is located far from the power supply filter
 ** C_{OUT} required for stability. Capacitor must operate at minimum temperature expected

Figure 19. Test and Application Circuit Showing Output Compensation

SETTING THE DELAY TIME

The delay time is controlled by the Reset Delay Low Voltage, Delay Switching Threshold, and the Delay Charge Current. The delay follows the equation:

$$t_{DELAY} = \frac{[C_{DELAY}(V_{dt} - \text{Reset Delay Low Voltage})]}{\text{Delay Charge Current}}$$

Example:

Using $C_{DELAY} = 33 \text{ nF}$.

Assume reset Delay Low Voltage = 0.

Use the typical value for $V_{dt} = 1.8 \text{ V}$.

Use the typical value for Delay Charge Current = $2.5 \mu\text{A}$.

$$t_{DELAY} = \frac{[33 \text{ nF}(1.8 - 0)]}{2.5 \mu\text{A}} = 23.8 \text{ ms}$$

STABILITY CONSIDERATIONS

The output or compensation capacitor helps determine three main characteristics of a linear regulator: start-up delay, load transient response and loop stability.

The capacitor value and type should be based on cost, availability, size and temperature constraints. A tantalum or aluminum electrolytic capacitor is best, since a film or ceramic capacitor with almost zero ESR can cause instability. The aluminum electrolytic capacitor is the least expensive solution, but, if the circuit operates at low temperatures (-25°C to -40°C), both the value and ESR of the capacitor will vary considerably. The capacitor manufacturers data sheet usually provides this information.

The value for the output capacitor C_{OUT} shown in Figure 19 should work for most applications, however it is not necessarily the optimized solution.

CALCULATING POWER DISSIPATION IN A SINGLE OUTPUT LINEAR REGULATOR

The maximum power dissipation for a single output regulator (Figure 20) is:

$$P_{D(max)} = [V_{IN(max)} - V_{OUT(min)}]I_{OUT(max)} + V_{IN(max)}I_Q \quad (eq. 1)$$

where:

- $V_{IN(max)}$ is the maximum input voltage,
- $V_{OUT(min)}$ is the minimum output voltage,
- $I_{OUT(max)}$ is the maximum output current for the application, and
- I_Q is the quiescent current the regulator consumes at $I_{OUT(max)}$.

Once the value of $P_{D(max)}$ is known, the maximum permissible value of $R_{\theta JA}$ can be calculated:

$$R_{\theta JA} = \frac{150^{\circ}C - T_A}{P_D} \quad (eq. 2)$$

The value of $R_{\theta JA}$ can then be compared with those in the package section of the data sheet. Those packages with $R_{\theta JA}$'s less than the calculated value in Equation 2 will keep the die temperature below 150°C.

In some cases, none of the packages will be sufficient to dissipate the heat generated by the IC, and an external heatsink will be required.

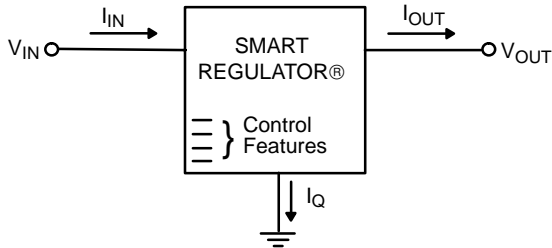

Figure 20. Single Output Regulator with Key Performance Parameters Labeled

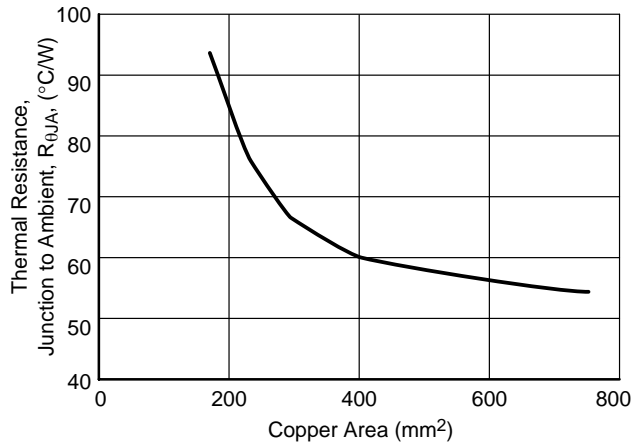

Figure 21. 16 Lead SOW (Exposed Pad), θ_{JA} as a Function of the Pad Copper Area (2 oz. Cu Thickness), Board Material = 0.0625" G-10/R-4

HEATSINKS

A heatsink effectively increases the surface area of the package to improve the flow of heat away from the IC and into the surrounding air.

Each material in the heat flow path between the IC and the outside environment will have a thermal resistance. Like series electrical resistances, these resistances are summed to determine the value of $R_{\theta JA}$:

$$R_{\theta JA} = R_{\theta JC} + R_{\theta CS} + R_{\theta SA} \quad (eq. 3)$$

where:

- $R_{\theta JC}$ = the junction-to-case thermal resistance,
- $R_{\theta CS}$ = the case-to-heatsink thermal resistance, and
- $R_{\theta SA}$ = the heatsink-to-ambient thermal resistance.

$R_{\theta JC}$ appears in the package section of the data sheet. Like $R_{\theta JA}$, it too is a function of package type. $R_{\theta CS}$ and $R_{\theta SA}$ are functions of the package type, heatsink and the interface between them. These values appear in heatsink data sheets of heatsink manufacturers.

NCV8501 Series

ORDERING INFORMATION

Device	Output Voltage	Package	Shipping†
NCV8501DADJ	Adjustable	SO-8	98 Units/Rail
NCV8501DADJG	Adjustable	SO-8 (Pb-Free)	98 Units/Rail
NCV8501DADJR2	Adjustable	SO-8	2500 Tape & Reel
NCV8501DADJR2G	Adjustable	SO-8 (Pb-Free)	2500 Tape & Reel
NCV8501PDWADJ	Adjustable	SOW-16 Exposed Pad	47 Units/Rail
NCV8501PDWADJR2			1000 Tape & Reel
NCV8501D25	2.5 V	SO-8	98 Units/Rail
NCV8501D25G	2.5 V	SO-8 (Pb-Free)	98 Units/Rail
NCV8501D25R2	2.5 V	SO-8	2500 Tape & Reel
NCV8501D25R2G	2.5 V	SO-8 (Pb-Free)	2500 Tape & Reel
NCV8501PDW25	2.5 V	SOW-16 Exposed Pad	47 Units/Rail
NCV8501PDW25R2			1000 Tape & Reel
NCV8501D33	3.3 V	SO-8	98 Units/Rail
NCV8501D33G	3.3 V	SO-8 (Pb-Free)	98 Units/Rail
NCV8501D33R2	3.3 V	SO-8	2500 Tape & Reel
NCV8501D33R2G	3.3 V	SO-8 (Pb-Free)	2500 Tape & Reel
NCV8501PDW33	3.3 V	SOW-16 Exposed Pad	47 Units/Rail
NCV8501PDW33R2			1000 Tape & Reel
NCV8501D50	5.0 V	SO-8	98 Units/Rail
NCV8501D50G	5.0 V	SO-8 (Pb-Free)	98 Units/Rail
NCV8501D50R2	5.0 V	SO-8	2500 Tape & Reel
NCV8501D50R2G	5.0 V	SO-8 (Pb-Free)	2500 Tape & Reel
NCV8501PDW50	5.0 V	SOW-16 Exposed Pad	47 Units/Rail
NCV8501PDW50R2			1000 Tape & Reel
NCV8501D80	8.0 V	SO-8	98 Units/Rail
NCV8501D80G	8.0 V	SO-8 (Pb-Free)	98 Units/Rail
NCV8501D80R2	8.0 V	SO-8	2500 Tape & Reel
NCV8501D80R2G	8.0 V	SO-8 (Pb-Free)	2500 Tape & Reel
NCV8501PDW80	8.0 V	SOW-16 Exposed Pad	47 Units/Rail
NCV8501PDW80R2			1000 Tape & Reel
NCV8501D100	10 V	SO-8	98 Units/Rail
NCV8501D100G	10 V	SO-8 (Pb-free)	98 Units/Rail
NCV8501D100R2	10 V	SO-8	2500 Tape & Reel
NCV8501D100R2G	10 V	SO-8 (Pb-Free)	2500 Tape & Reel
NCV8501PDW100	10 V	SOW-16 Exposed Pad	47 Units/Rail
NCV8501PDW100R2			1000 Tape & Reel

†For information on tape and reel specifications, including part orientation and tape sizes, please refer to our Tape and Reel Packaging Specification Brochure, BRD8011/D.

NCV8501 Series

PACKAGE DIMENSIONS

SO-8 NB
D SUFFIX
CASE 751-07
ISSUE AB

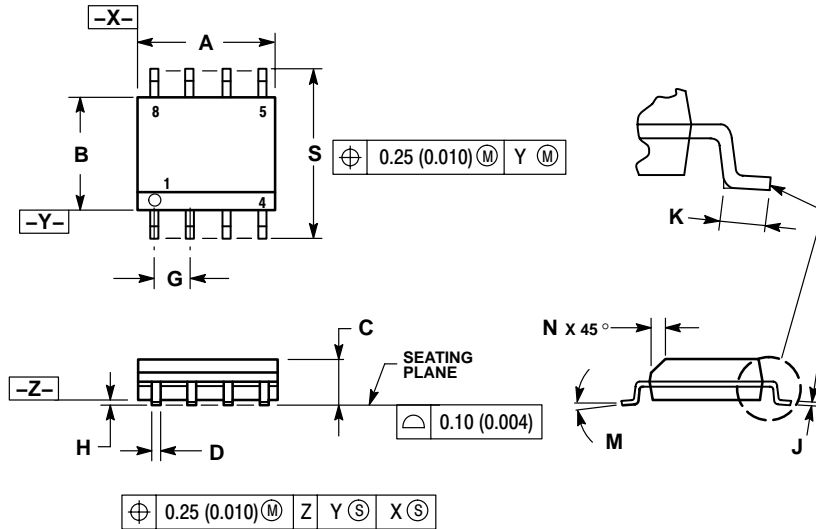

NOTES:

1. DIMENSIONING AND TOLERANCING PER ANSI Y14.5M, 1982.
2. CONTROLLING DIMENSION: MILLIMETER.
3. DIMENSION A AND B DO NOT INCLUDE MOLD PROTRUSION.
4. MAXIMUM MOLD PROTRUSION 0.15 (0.006) PER SIDE.
5. DIMENSION D DOES NOT INCLUDE DAMBAR PROTRUSION. ALLOWABLE DAMBAR PROTRUSION SHALL BE 0.127 (0.005) TOTAL IN EXCESS OF THE D DIMENSION AT MAXIMUM MATERIAL CONDITION.
6. 751-01 THRU 751-06 ARE OBSOLETE. NEW STANDARD IS 751-07.

DIM	MILLIMETERS		INCHES	
	MIN	MAX	MIN	MAX
A	4.80	5.00	0.189	0.197
B	3.80	4.00	0.150	0.157
C	1.35	1.75	0.053	0.069
D	0.33	0.51	0.013	0.020
G	1.27 BSC		0.050 BSC	
H	0.10	0.25	0.004	0.010
J	0.19	0.25	0.007	0.010
K	0.40	1.27	0.016	0.050
M	0°	8°	0°	8°
N	0.25	0.50	0.010	0.020
S	5.80	6.20	0.228	0.244

SOLDERING FOOTPRINT*

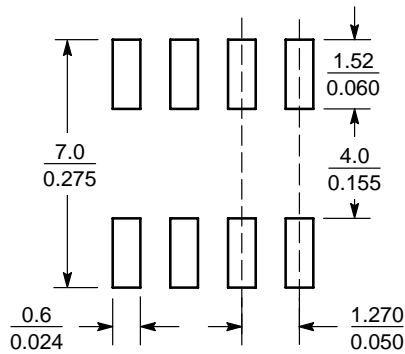

SCALE 6:1 $\left(\frac{\text{mm}}{\text{inches}}\right)$

*For additional information on our Pb-Free strategy and soldering details, please download the ON Semiconductor Soldering and Mounting Techniques Reference Manual, SOLDERRM/D.

NCV8501 Series

PACKAGE DIMENSIONS

SOIC 16 LEAD WIDE BODY
EXPOSED PAD
PDW SUFFIX
CASE 751R-02
ISSUE A

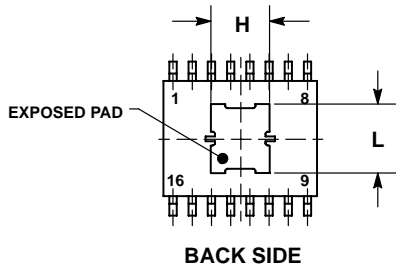
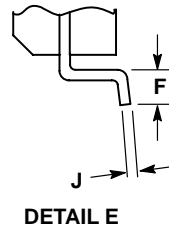
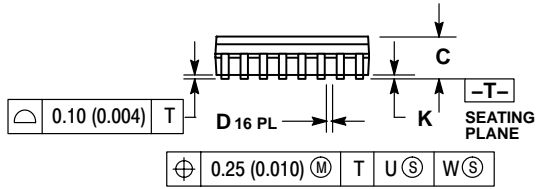
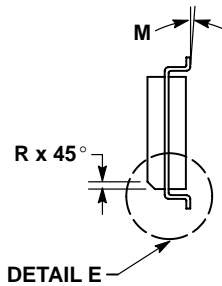
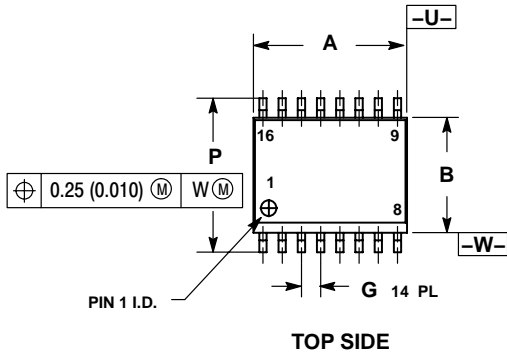

NOTES:

1. DIMENSIONING AND TOLERANCING PER ANSI Y14.5M, 1982.
2. CONTROLLING DIMENSION: MILLIMETER.
3. DIMENSION A AND B DO NOT INCLUDE MOLD PROTRUSION.
4. MAXIMUM MOLD PROTRUSION 0.15 (0.006) PER SIDE.
5. DIMENSION D DOES NOT INCLUDE DAMBAR PROTRUSION. ALLOWABLE PROTRUSION SHALL BE 0.13 (0.005) TOTAL IN EXCESS OF THE D DIMENSION AT MAXIMUM MATERIAL CONDITION.
6. 751R-01 OBSOLETE, NEW STANDARD 751R-02.

DIM	MILLIMETERS		INCHES	
	MIN	MAX	MIN	MAX
A	10.15	10.45	0.400	0.411
B	7.40	7.60	0.292	0.299
C	2.35	2.65	0.093	0.104
D	0.35	0.49	0.014	0.019
F	0.50	0.90	0.020	0.035
G	1.27 BSC		0.050 BSC	
H	3.76	3.86	0.148	0.152
J	0.25	0.32	0.010	0.012
K	0.10	0.25	0.004	0.009
L	4.58	4.78	0.180	0.188
M	0 °	7 °	0 °	7 °
P	10.05	10.55	0.395	0.415
R	0.25	0.75	0.010	0.029

NCV8501 Series

SMART REGULATOR is a registered trademark of Semiconductor Components Industries, LLC.

ON Semiconductor and  are registered trademarks of Semiconductor Components Industries, LLC (SCILLC). SCILLC reserves the right to make changes without further notice to any products herein. SCILLC makes no warranty, representation or guarantee regarding the suitability of its products for any particular purpose, nor does SCILLC assume any liability arising out of the application or use of any product or circuit, and specifically disclaims any and all liability, including without limitation special, consequential or incidental damages. "Typical" parameters which may be provided in SCILLC data sheets and/or specifications can and do vary in different applications and actual performance may vary over time. All operating parameters, including "Typicals" must be validated for each customer application by customer's technical experts. SCILLC does not convey any license under its patent rights nor the rights of others. SCILLC products are not designed, intended, or authorized for use as components in systems intended for surgical implant into the body, or other applications intended to support or sustain life, or for any other application in which the failure of the SCILLC product could create a situation where personal injury or death may occur. Should Buyer purchase or use SCILLC products for any such unintended or unauthorized application, Buyer shall indemnify and hold SCILLC and its officers, employees, subsidiaries, affiliates, and distributors harmless against all claims, costs, damages, and expenses, and reasonable attorney fees arising out of, directly or indirectly, any claim of personal injury or death associated with such unintended or unauthorized use, even if such claim alleges that SCILLC was negligent regarding the design or manufacture of the part. SCILLC is an Equal Opportunity/Affirmative Action Employer. This literature is subject to all applicable copyright laws and is not for resale in any manner.

PUBLICATION ORDERING INFORMATION

LITERATURE FULFILLMENT:

Literature Distribution Center for ON Semiconductor
P.O. Box 61312, Phoenix, Arizona 85082-1312 USA
Phone: 480-829-7710 or 800-344-3860 Toll Free USA/Canada
Fax: 480-829-7709 or 800-344-3867 Toll Free USA/Canada
Email: orderlit@onsemi.com

N. American Technical Support: 800-282-9855 Toll Free
USA/Canada

Japan: ON Semiconductor, Japan Customer Focus Center
2-9-1 Kamimeguro, Meguro-ku, Tokyo, Japan 153-0051
Phone: 81-3-5773-3850

ON Semiconductor Website: <http://onsemi.com>

Order Literature: <http://www.onsemi.com/litorder>

For additional information, please contact your
local Sales Representative.