

PRELIMINARY

PD-97178

International  
**IR** Rectifier

**RADIATION HARDENED  
LOGIC LEVEL POWER MOSFET  
THRU-HOLE (MO-036AB)**

**2N7612M1  
IRHLG77110  
100V, Quad N-CHANNEL  
TECHNOLOGY**



**Product Summary**

| Part Number | Radiation Level | RDS(on) | ID   |
|-------------|-----------------|---------|------|
| IRHLG77110  | 100K Rads (Si)  | 0.22Ω   | 1.8A |
| IRHLG73110  | 300K Rads (Si)  | 0.22Ω   | 1.8A |

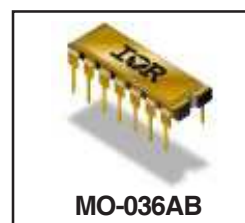

International Rectifier's R7™ Logic Level Power MOSFETs provide simple solution to interfacing CMOS and TTL control circuits to power devices in space and other radiation environments. The threshold voltage remains within acceptable operating limits over the full operating temperature and post radiation. This is achieved while maintaining single event gate rupture and single event burnout immunity.

These devices are used in applications such as current boost low signal source in PWM, voltage comparator and operational amplifiers.

**Features:**

- 5V CMOS and TTL Compatible
- Fast Switching
- Single Event Effect (SEE) Hardened
- Low Total Gate Charge
- Simple Drive Requirements
- Ease of Paralleling
- Hermetically Sealed
- Light Weight

**Absolute Maximum Ratings**

**Pre-Irradiation**

|                           | Parameter                       |                                       | Units |
|---------------------------|---------------------------------|---------------------------------------|-------|
| ID @ VGS = 4.5V, TC=25°C  | Continuous Drain Current        | 1.8                                   | A     |
| ID @ VGS = 4.5V, TC=100°C | Continuous Drain Current        | 1.1                                   |       |
| IDM                       | Pulsed Drain Current ①          | 7.2                                   |       |
| PD @ TC = 25°C            | Max. Power Dissipation          | 1.4                                   | W     |
|                           | Linear Derating Factor          | 0.01                                  | W/°C  |
| VGS                       | Gate-to-Source Voltage          | ±10                                   | V     |
| EAS                       | Single Pulse Avalanche Energy ② | 97                                    | mJ    |
| IAR                       | Avalanche Current ①             | 1.8                                   | A     |
| EAR                       | Repetitive Avalanche Energy ①   | 0.14                                  | mJ    |
| dv/dt                     | Peak Diode Recovery dv/dt ③     | 11                                    | V/ns  |
| TJ                        | Operating Junction              | -55 to 150                            | °C    |
| TSTG                      | Storage Temperature Range       |                                       |       |
|                           | Lead Temperature                | 300 (0.063in/1.6mm from case for 10s) |       |
|                           | Weight                          | 1.3 (Typical)                         | g     |

For footnotes refer to the last page

www.irf.com

## PRELIMINARY

IRHLG77110, 2N7612M1

Pre-Irradiation

### Electrical Characteristics For Each N-Channel Device @ T<sub>J</sub> = 25°C (Unless Otherwise specified)

|                                       | Parameter                                    | Min | Typ  | Max  | Units | Test Conditions  |
|---------------------------------------|--|-----|------|------|-------|--|
| B <sub>V</sub> DSS                    | Drain-to-Source Breakdown Voltage            | 100 | —    | —    | V     | V <sub>GS</sub> = 0V, I <sub>D</sub> = 250μA   |
| ΔB <sub>V</sub> DSS/ΔT <sub>J</sub>   | Temperature Coefficient of Breakdown Voltage | —   | 0.11 | —    | V/°C  | Reference to 25°C, I <sub>D</sub> = 1.0mA  |
| R <sub>DS(on)</sub>                   | Static Drain-to-Source On-State Resistance   | —   | —    | 0.22 | Ω     | V <sub>GS</sub> = 4.5V, I <sub>D</sub> = 1.1A <sup>④</sup>   |
| V <sub>GS(th)</sub>                   | Gate Threshold Voltage                       | 1.0 | —    | 2.0  | V     | V <sub>DS</sub> = V <sub>GS</sub> , I <sub>D</sub> = 250μA   |
| ΔV <sub>GS(th)</sub> /ΔT <sub>J</sub> | Gate Threshold Voltage Coefficient           | —   | -4.4 | —    | mV/°C |  |
| g <sub>fs</sub>                       | Forward Transconductance                     | 3.0 | —    | —    | S     | V <sub>DS</sub> = 10V, I <sub>DS</sub> = 1.1A <sup>④</sup>   |
| I <sub>DSS</sub>                      | Zero Gate Voltage Drain Current              | —   | —    | 1.0  | μA    | V <sub>DS</sub> = 80V, V <sub>GS</sub> = 0V  |
|                                       |  | —   | —    | 10   |       | V <sub>DS</sub> = 80V, V <sub>GS</sub> = 0V, T <sub>J</sub> = 125°C  |
| I <sub>GSS</sub>                      | Gate-to-Source Leakage Forward               | —   | —    | 100  | nA    | V <sub>GS</sub> = 10V  |
| I <sub>GSS</sub>                      | Gate-to-Source Leakage Reverse               | —   | —    | -100 |       | V <sub>GS</sub> = -10V   |
| Q <sub>g</sub>                        | Total Gate Charge                            | —   | —    | 15   | nC    | V <sub>GS</sub> = 4.5V, I <sub>D</sub> = 1.8A  |
| Q <sub>gs</sub>                       | Gate-to-Source Charge                        | —   | —    | 2.5  |       | V <sub>DS</sub> = 50V  |
| Q <sub>gd</sub>                       | Gate-to-Drain ('Miller') Charge              | —   | —    | 6.0  |       |  |
| t <sub>d(on)</sub>                    | Turn-On Delay Time                           | —   | —    | 15   | ns    | V <sub>DD</sub> = 50V, I <sub>D</sub> = 1.8A, V <sub>GS</sub> = 4.5V, R <sub>G</sub> = 7.5Ω  |
| t <sub>r</sub>                        | Rise Time                                    | —   | —    | 20   |       |  |
| t <sub>d(off)</sub>                   | Turn-Off Delay Time                          | —   | —    | 65   |       |  |
| t <sub>f</sub>                        | Fall Time                                    | —   | —    | 25   |       |  |
| L <sub>S</sub> + L <sub>D</sub>       | Total Inductance                             | —   | 10   | —    | nH    | Measured from Drain lead (6mm /0.25in from pack.) to Source lead (6mm/0.25in from pack.) with Source wire internally bonded from Source pin to Drain pad |
| C <sub>iss</sub>                      | Input Capacitance                            | —   | 653  | —    | pF    | V <sub>GS</sub> = 0V, V <sub>DS</sub> = 25V<br>f = 1.0MHz  |
| C <sub>oss</sub>                      | Output Capacitance                           | —   | 119  | —    |       |  |
| C <sub>rss</sub>                      | Reverse Transfer Capacitance                 | —   | 2.7  | —    |       |  |
| R <sub>g</sub>                        | Gate Resistance                              | —   | 16   | —    | Ω     | f = 1.0MHz, open drain   |

### Source-Drain Diode Ratings and Characteristics (Per Die)

|                 | Parameter                                      | Min  | Typ | Max | Units | Test Conditions   |
|-----------------|--|--|-----|-----|-------|---|
| I <sub>S</sub>  | Continuous Source Current (Body Diode)         | —  | —   | 1.8 | A     | T <sub>J</sub> = 25°C, I <sub>S</sub> = 1.8A, V <sub>GS</sub> = 0V <sup>④</sup> |
| I <sub>SM</sub> | Pulse Source Current (Body Diode) <sup>①</sup> | —  | —   | 7.2 |       |   |
| V <sub>SD</sub> | Diode Forward Voltage                          | —  | —   | 1.2 | V     | T <sub>J</sub> = 25°C, I <sub>F</sub> = 1.8A, di/dt ≤ 100A/μs                   |
| t <sub>rr</sub> | Reverse Recovery Time                          | —  | —   | 100 | ns    | V <sub>DD</sub> ≤ 25V <sup>④</sup>  |
| Q <sub>RR</sub> | Reverse Recovery Charge                        | —  | —   | 223 | nC    |   |
| t <sub>on</sub> | Forward Turn-On Time                           | Intrinsic turn-on time is negligible. Turn-on speed is substantially controlled by L <sub>S</sub> + L <sub>D</sub> . |     |     |       |   |

### Thermal Resistance (Per Die)

|                   | Parameter           | Min | Typ | Max | Units | Test Conditions      |
|-------------------|---------------------|-----|-----|-----|-------|----------------------|
| R <sub>thJA</sub> | Junction-to-Ambient | —   | —   | 90  | °C/W  | Typical socket mount |

Note: Corresponding Spice and Saber models are available on International Rectifier Web site.

For footnotes refer to the last page

## PRELIMINARY

### Radiation Characteristics

IRHLG77110, 2N7612M1

International Rectifier Radiation Hardened MOSFETs are tested to verify their radiation hardness capability. The hardness assurance program at International Rectifier is comprised of two radiation environments. Every manufacturing lot is tested for total ionizing dose (per notes 5 and 6) using the TO-39 package. Both pre- and post-irradiation performance are tested and specified using the same drive circuitry and test conditions in order to provide a direct comparison.

**Table 1. Electrical Characteristics @ Tj = 25°C, Post Total Dose Irradiation ⑤⑥ (Per Die)**

|                     | Parameter   | Up to 300K Rads (Si) <sup>1</sup> |      | Units | Test Conditions  |
|---------------------|---|-----------------------------------|------|-------|--|
|                     |   | Min                               | Max  |       |  |
| BV <sub>DSS</sub>   | Drain-to-Source Breakdown Voltage                       | 100                               | —    | V     | V <sub>GS</sub> = 0V, I <sub>D</sub> = 250μA               |
| V <sub>GS(th)</sub> | Gate Threshold Voltage                                  | 1.0                               | 2.0  |       | V <sub>GS</sub> = V <sub>DS</sub> , I <sub>D</sub> = 250μA |
| I <sub>GSS</sub>    | Gate-to-Source Leakage Forward                          | —                                 | 100  | nA    | V <sub>GS</sub> = 10V                                      |
| I <sub>GSS</sub>    | Gate-to-Source Leakage Reverse                          | —                                 | -100 |       | V <sub>GS</sub> = -10V                                     |
| I <sub>DSS</sub>    | Zero Gate Voltage Drain Current                         | —                                 | 10   | μA    | V <sub>DS</sub> = 80V, V <sub>GS</sub> = 0V                |
| R <sub>DS(on)</sub> | Static Drain-to-Source On-State Resistance (TO-39) ④    | —                                 | 0.25 | Ω     | V <sub>GS</sub> = 4.5V, I <sub>D</sub> = 1.1A              |
| R <sub>DS(on)</sub> | Static Drain-to-Source On-state Resistance (MO-036AB) ④ | —                                 | 0.22 | Ω     | V <sub>GS</sub> = 4.5V, I <sub>D</sub> = 1.1A              |
| V <sub>SD</sub>     | Diode Forward Voltage ④                                 | —                                 | 1.2  | V     | V <sub>GS</sub> = 0V, I <sub>D</sub> = 1.8A                |

1. Part numbers IRHLG77110, IRHLG73110

International Rectifier radiation hardened MOSFETs have been characterized in heavy ion environment for Single Event Effects (SEE). Single Event Effects characterization is illustrated in Fig. a and Table 2.

**Table 2. Typical Single Event Effect Safe Operating Area (Per Die)**

| Ion | LET<br>(MeV/(mg/cm <sup>2</sup> )) | Energy<br>(MeV) | Range<br>(μm) | VDS (V)     |              |              |              |              |              |              |              |
|-----|------------------------------------|-----------------|---------------|-------------|--------------|--------------|--------------|--------------|--------------|--------------|--------------|
|     |                                    |                 |               | @VGS=<br>0V | @VGS=<br>-1V | @VGS=<br>-2V | @VGS=<br>-4V | @VGS=<br>-5V | @VGS=<br>-6V | @VGS=<br>-7V | @VGS=<br>-8V |
| Br  | 37                                 | 305             | 39            | 100         | 100          | 100          | 100          | 100          | 100          | 100          | 100          |
| I   | 60                                 | 370             | 34            | 100         | 100          | 100          | 100          | 100          | 100          | -            | -            |
| Au  | 84                                 | 390             | 30            | 100         | 100          | 100          | 100          | 100          | -            | -            | -            |

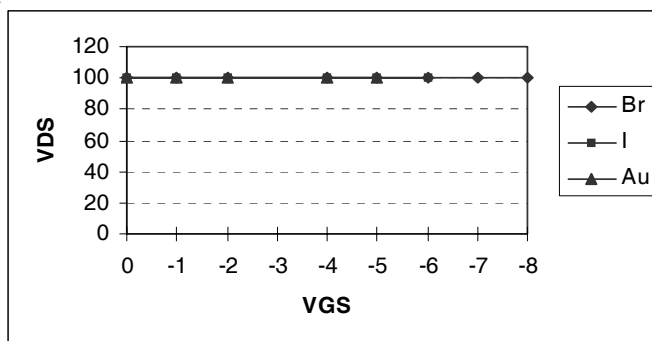

**Fig a. Typical Single Event Effect, Safe Operating Area**

For footnotes refer to the last page

www.irf.com

PRELIMINARY

IRHLG77110, 2N7612M1

Pre-Irradiation

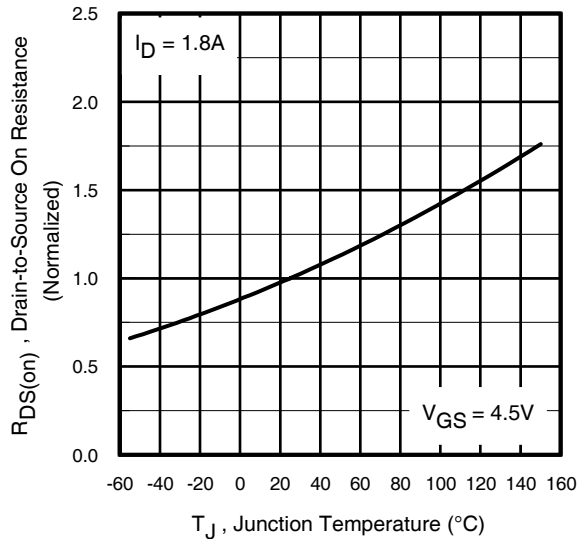
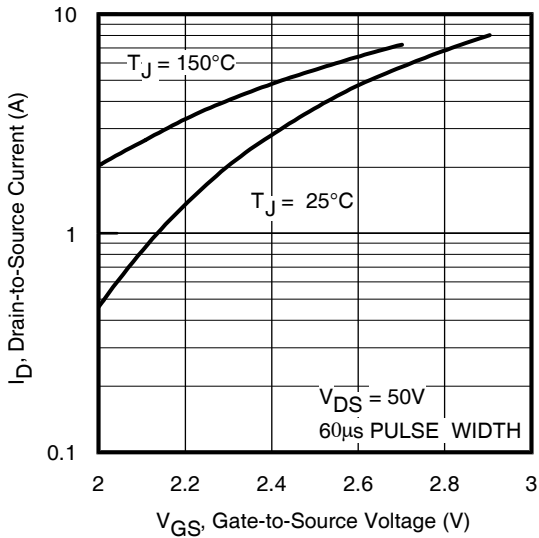
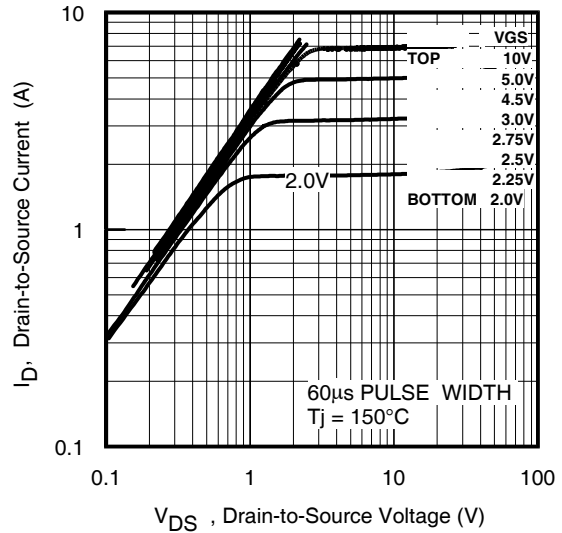
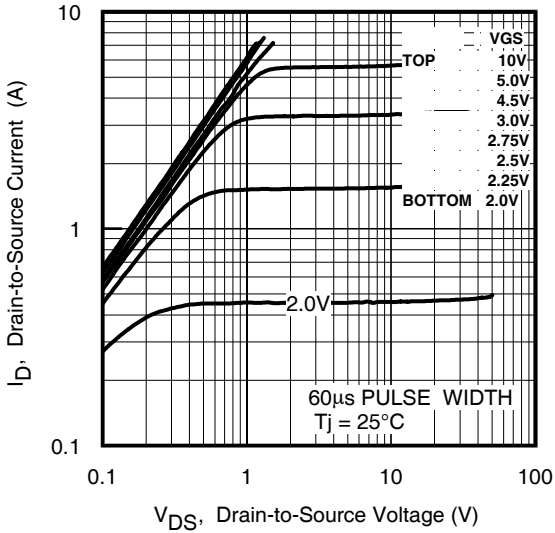

PRELIMINARY

Pre-Irradiation

IRHLG77110, 2N7612M1

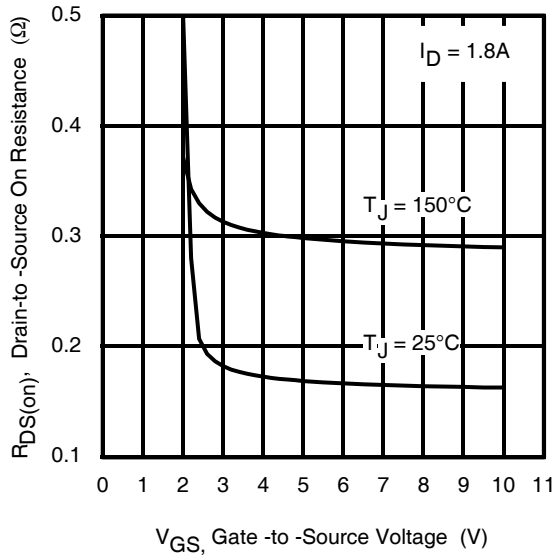

Fig 5. Typical On-Resistance Vs Gate Voltage

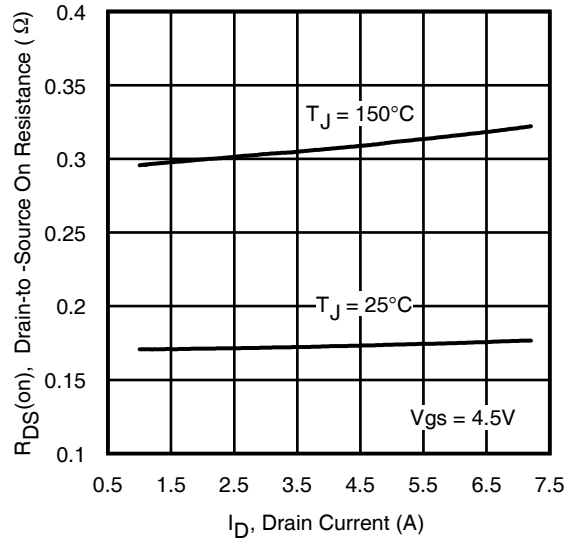

Fig 6. Typical On-Resistance Vs Drain Current

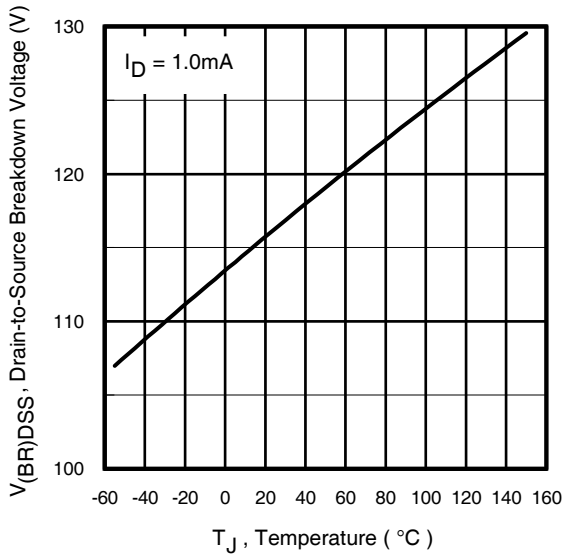

Fig 7. Typical Drain-to-Source Breakdown Voltage Vs Temperature

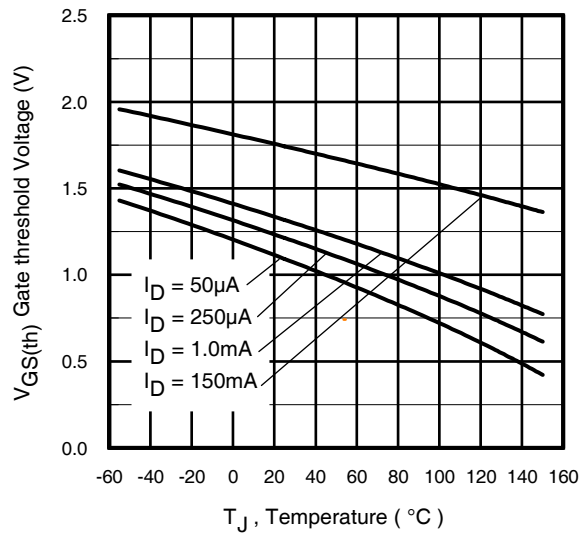

Fig 8. Typical Threshold Voltage Vs Temperature

PRELIMINARY

IRHLG77110, 2N7612M1

Pre-Irradiation

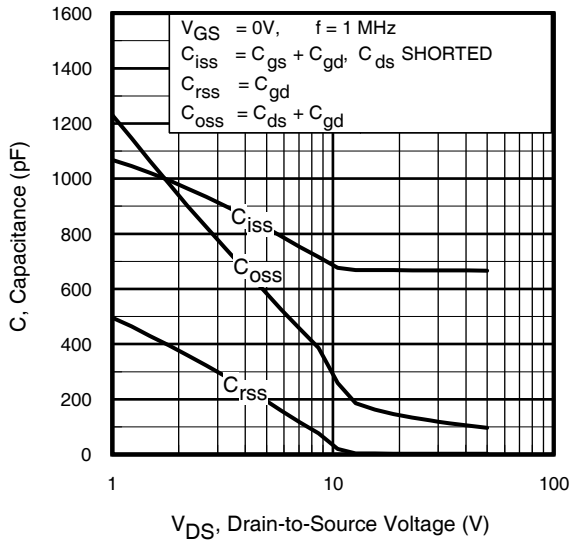

Fig 9. Typical Capacitance Vs. Drain-to-Source Voltage

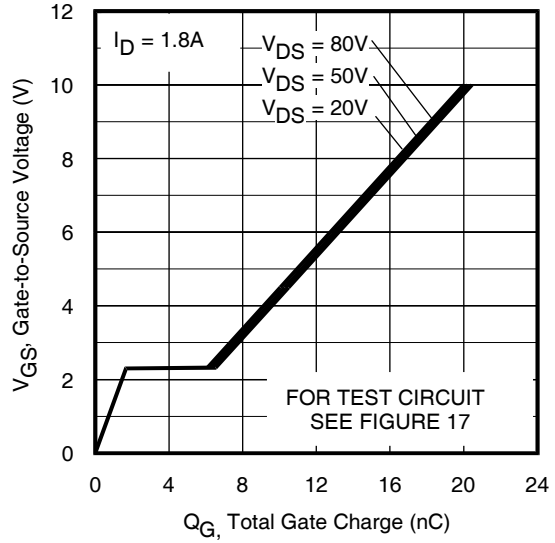

Fig 10. Typical Gate Charge Vs. Gate-to-Source Voltage

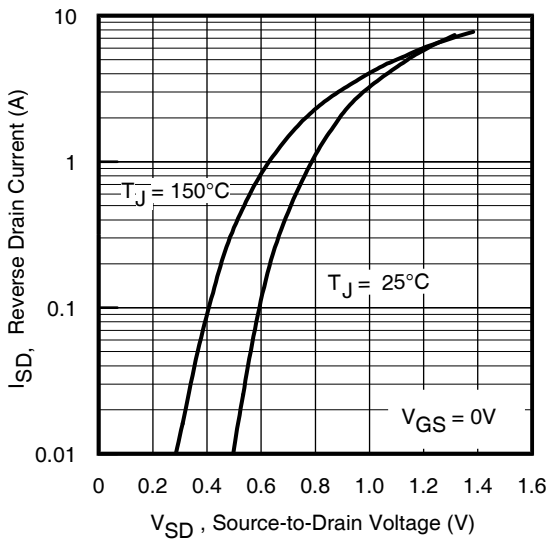

Fig 11. Typical Source-to-Drain Diode Forward Voltage

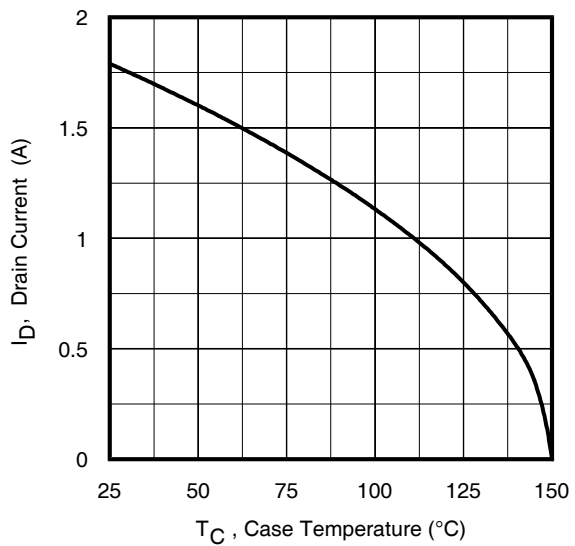

Fig 12. Maximum Drain Current Vs. Case Temperature

PRELIMINARY

Pre-Irradiation

IRHLG77110, 2N7612M1

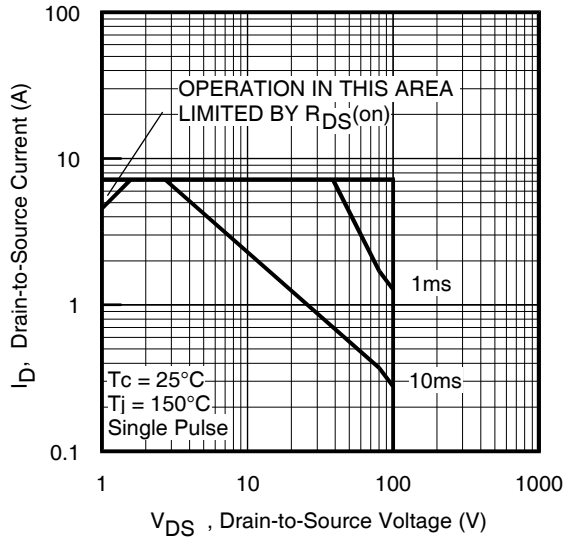

Fig 13. Maximum Safe Operating Area

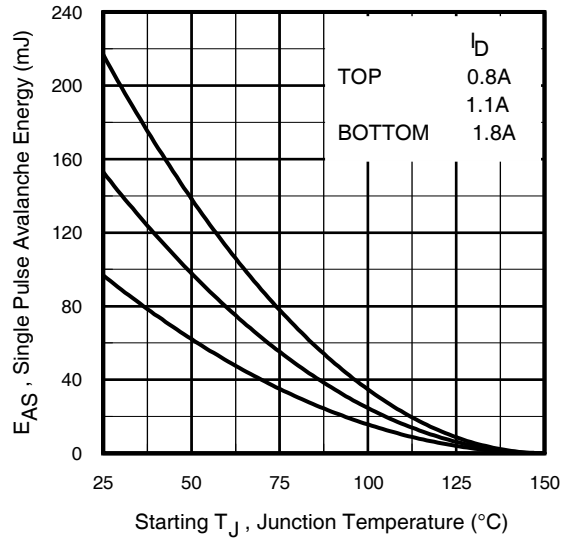

Fig 14. Maximum Avalanche Energy Vs. Drain Current

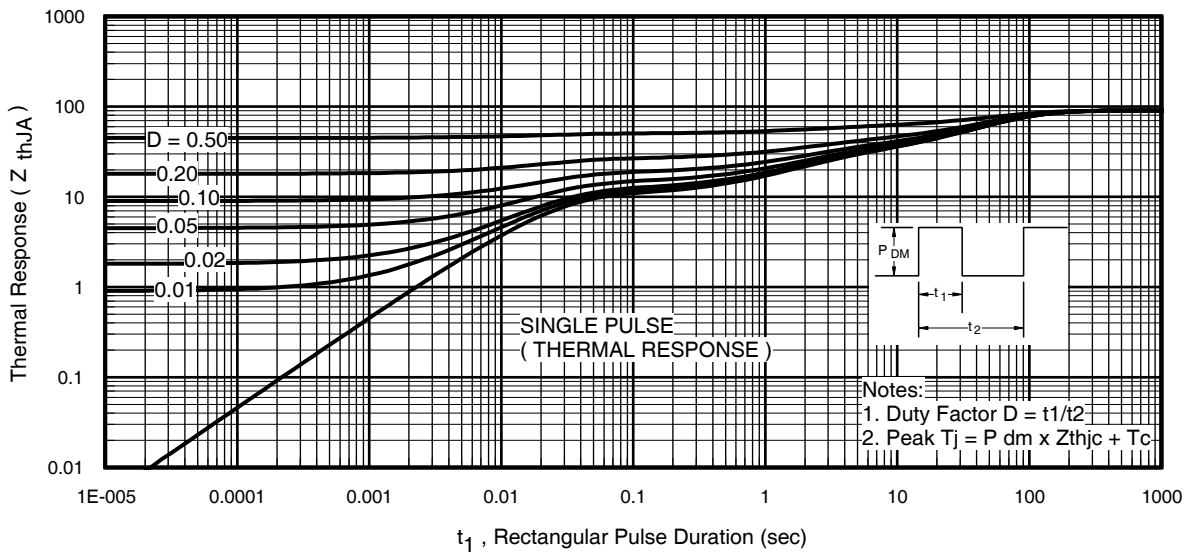

Fig 15. Maximum Effective Transient Thermal Impedance, Junction-to-Ambient

PRELIMINARY

IRHLG77110, 2N7612M1

Pre-Irradiation

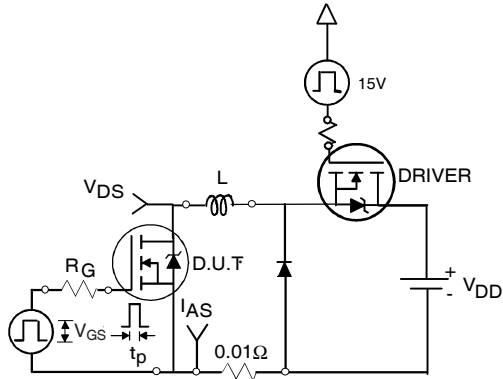

Fig 16a. Unclamped Inductive Test Circuit

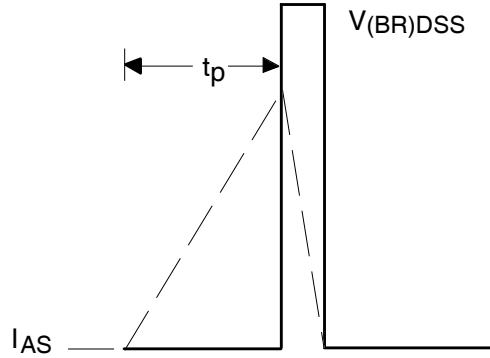

Fig 16b. Unclamped Inductive Waveforms

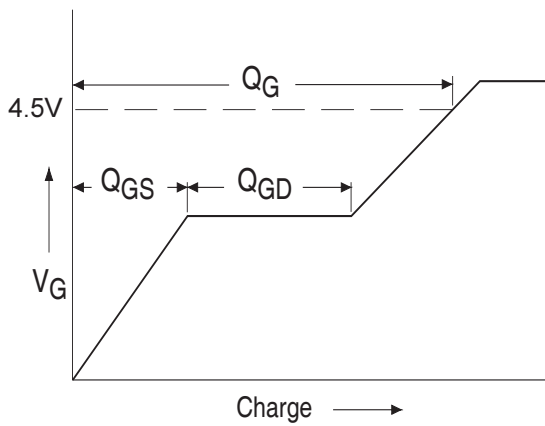

Fig 17a. Basic Gate Charge Waveform

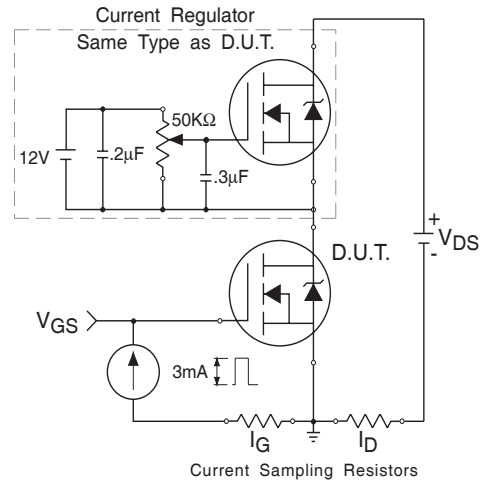

Fig 17b. Gate Charge Test Circuit

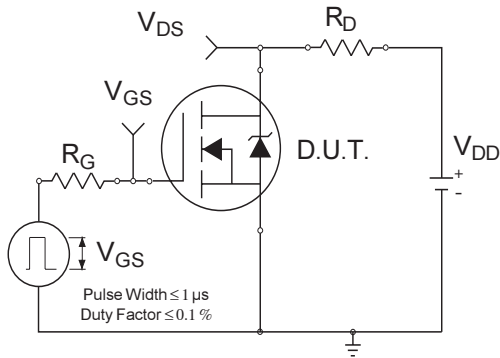

Fig 18a. Switching Time Test Circuit

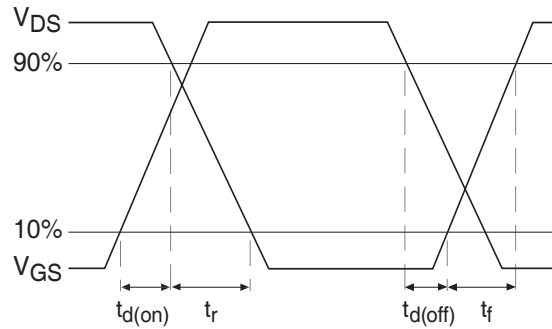

Fig 18b. Switching Time Waveforms



## PRELIMINARY

Pre-Irradiation

IRHLG77110, 2N7612M1

### Footnotes:

- ① Repetitive Rating; Pulse width limited by maximum junction temperature.
- ②  $V_{DD} = 25V$ , starting  $T_J = 25^\circ C$ ,  $L = 6.6mH$   
Peak  $I_L = 1.8A$ ,  $V_{GS} = 10V$
- ③  $I_{SD} \leq 1.8A$ ,  $di/dt \leq 497A/\mu s$ ,  
 $V_{DD} \leq 100V$ ,  $T_J \leq 150^\circ C$
- ④ Pulse width  $\leq 300 \mu s$ ; Duty Cycle  $\leq 2\%$
- ⑤ **Total Dose Irradiation with  $V_{GS}$  Bias.**  
10 volt  $V_{GS}$  applied and  $V_{DS} = 0$  during irradiation per MIL-STD-750, method 1019, condition A.
- ⑥ **Total Dose Irradiation with  $V_{DS}$  Bias.**  
80 volt  $V_{DS}$  applied and  $V_{GS} = 0$  during irradiation per MIL-STD-750, method 1019, condition A.

### Case Outline and Dimensions — MO-036AB

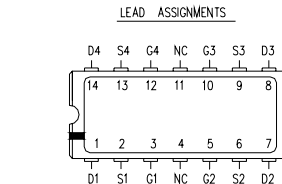
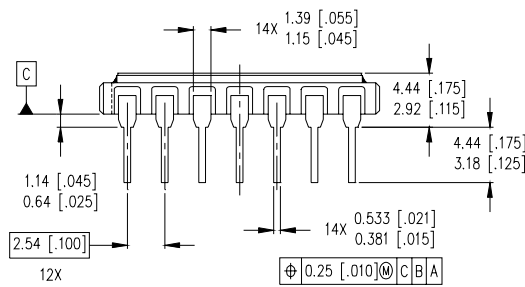
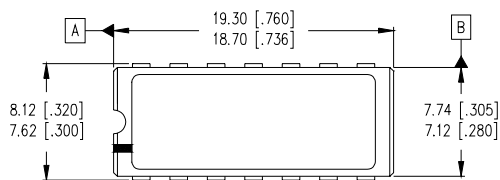

**LEGEND**  
 G = GATE      S = SOURCE  
 D = DRAIN    NC = NO CONNECTION

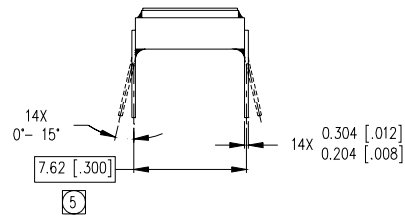

**NOTES:**

- 1. DIMENSIONING & TOLERANCING PER ASME Y14.5M-1994.
- 2. CONTROLLING DIMENSION: INCH.
- 3. DIMENSIONS ARE SHOWN IN MILLIMETERS [INCHES].
- 4. OUTLINE CONFORMS TO JEDEC OUTLINE MO-036AB.
- ⑤ MEASURED WITH THE LEADS CONSTRAINED TO BE PERPENDICULAR TO DATUM PLANE C.

International  
**IR** Rectifier

**IR WORLD HEADQUARTERS:** 233 Kansas St., El Segundo, California 90245, USA Tel: (310) 252-7105  
**IR LEOMINSTER :** 205 Crawford St., Leominster, Massachusetts 01453, USA Tel: (978) 534-5776  
 TAC Fax: (310) 252-7903

Visit us at [www.irf.com](http://www.irf.com) for sales contact information.  
*Data and specifications subject to change without notice. 03/2011*

[www.irf.com](http://www.irf.com)