

# High-Intensity LED in Plastic T-1<sup>3</sup>/<sub>4</sub> Package



## OVLGx0CyB9 Series

### Features:

- Narrow beam angle
- High brightness LED
- Water clear plastic package
- UV resistant epoxy



### Description:

Each device in the **OVLG Series** is a high intensity LED mounted in a clear plastic T-1<sup>3</sup>/<sub>4</sub> package. Each device incorporates an integral molded lens that enables a narrow beam angle and provides an even emission pattern. Designed to produce light over a wide range of drive currents, these LEDs are useful in applications that require a higher on-axis brightness than that achievable with standard lamps.

### Applications:

- Indoor/outdoor applications
- Variable message boards
- Store front signage

Part Number	Material	Emitted Color	Intensity Typ. mcd	Lens Color
OVLGB0C6B9	InGaN	Blue	7,200	Clear
OVLGC0C6B9		Blue-Green	23,000	
OVLGS0C8B9	AlInGaP	Red	14,000	
OVLGY0C9B9		Yellow	14,000	

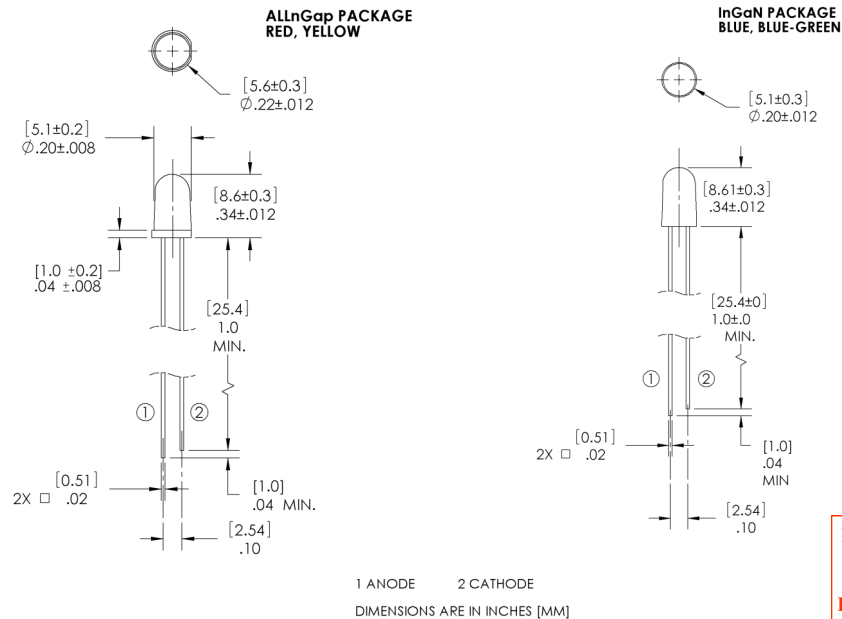

**DO NOT LOOK DIRECTLY  
AT LED WITH  
UNSHIELDED EYES OR  
DAMAGE TO RETINA MAY**

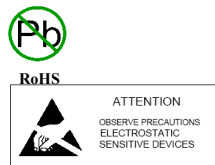

### General Note

TT Electronics reserves the right to make changes in product specification without notice or liability. All information is subject to TT Electronics' own data and is considered accurate at time of going to print.

TT Electronics | Optek Technology, Inc.  
1645 Wallace Drive, Ste. 130, Carrollton, TX USA 75006 | Ph: +1 972 323 2200  
www.ttelectronics.com | sensors@ttelectronics.com

# High-Intensity LED in Plastic T-1<sup>3/4</sup> Package



## OVLGx0CyB9 Series

### Absolute Maximum Ratings ( $T_A = 25^\circ\text{C}$ unless otherwise noted)

Storage Temperature Range		-40 ~ +100 °C
Operating Temperature Range		-40 ~ +100 °C
Reverse Voltage		5 V
Continuous Forward Current	Blue, Blue-Green	25 mA
	Red, Yellow	50 mA
Peak Forward Current (10% Duty Cycle, 1 kHz)		100 mA
Power Dissipation	Blue, Blue-Green	100 mW
	Red, Yellow	120 mW
Current Linearity vs Ambient Temperature	Blue, Blue-Green	-0.29 mA/° C
	Red, Yellow	-0.72 mA/° C
LED Junction Temperature		125° C
Electrostatic Discharge Classification (JEDEC-JESD22-A114F)		Class 1C
Lead Soldering Temperature (3 mm from the base of the epoxy bulb) <sup>1</sup>		260° C / 5 seconds

### Electrical Characteristics ( $T_A = 25^\circ\text{C}$ unless otherwise noted)

SYMBOL	PARAMETER	COLOR	MIN	TYP	MAX	UNITS	CONDITIONS
$I_V$	Luminous Intensity	Blue	4,360	7,200	----	mcd	$I_F = 20\text{ mA}$
		Blue-Green	11,970	23,000	----		
		Red	8,550	14,000	----		
		Yellow	8,550	14,000	----		
$V_F$	Forward Voltage	Blue	2.6	3.2	4.0	V	$I_F = 20\text{ mA}$
		Blue-Green					
		Red	1.8	2.0	2.4		
		Yellow					
$I_R$	Reverse Current	Blue	----	----	10	$\mu\text{A}$	$V_R = 5\text{ V}$
		Blue-Green					
		Red					
		Yellow					
$\lambda_D$	Dominant Wavelength	Blue	460	470	475	nm	$I_F = 20\text{ mA}$
		Blue-Green	499	505	511		
		Red	620	623	630		
		Yellow	585	589	595		
20% $\theta$ -H	50% Power Angle	Blue	----	15	----	deg	$I_F = 20\text{ mA}$
		Blue-Green	----	15	----		
		Red	----	8	----		
		Yellow	----	8	----		

#### General Note

TT Electronics reserves the right to make changes in product specification without notice or liability. All information is subject to TT Electronics' own data and is considered accurate at time of going to print.

TT Electronics | Optek Technology, Inc.  
1645 Wallace Drive, Ste. 130, Carrollton, TX USA 75006 | Ph: +1 972 323 2200  
www.ttelectronics.com | sensors@ttelectronics.com

# High-Intensity LED in Plastic T-1<sup>3</sup>/<sub>4</sub> Package



## OVLGx0CyB9 Series

### Typical Electro-Optical Characteristics Curves—Blue & Blue-Green

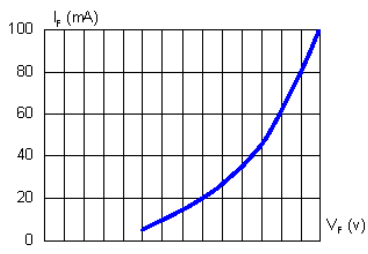

Fig.1 Forward Current vs. Forward Voltage

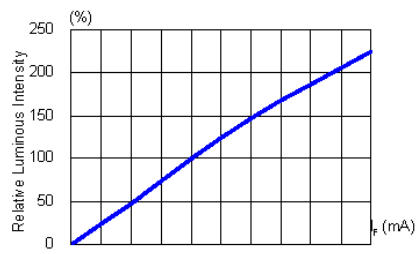

Fig.2 Luminous Intensity vs. Forward Current

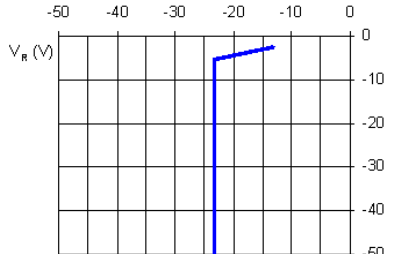

Fig.3 Reverse Current vs. Reverse Voltage

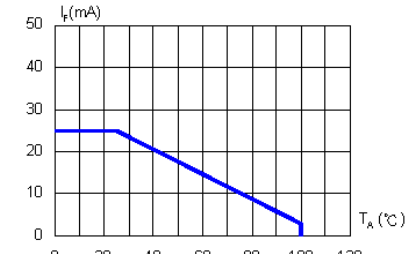

Fig.4 Allowable Forward Current vs. Ambient Temperature

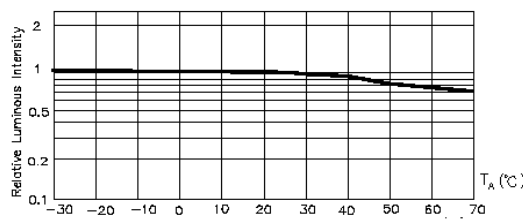

Fig.5 Luminous Intensity at I<sub>f</sub> = 20mA vs. Ambient Temperature

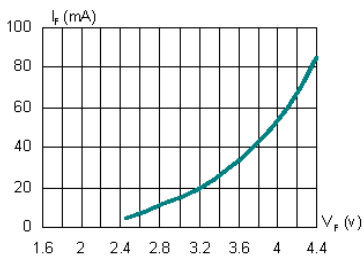

Fig.1 Forward Current vs. Forward Voltage

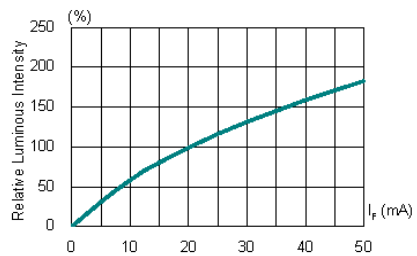

Fig.2 Luminous Intensity vs. Forward Current

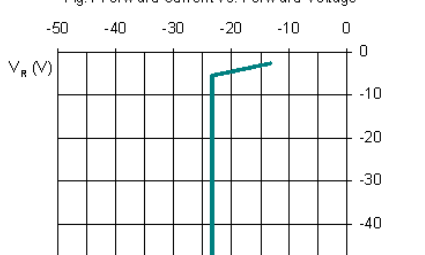

Fig.3 Reverse Current vs. Reverse Voltage

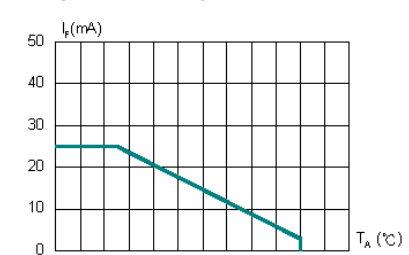

Fig.4 Allowable Forward Current vs. Ambient Temperature

**General Note**

TT Electronics reserves the right to make changes in product specification without notice or liability. All information is subject to TT Electronics' own data and is considered accurate at time of going to print.

TT Electronics | Optek Technology, Inc.  
1645 Wallace Drive, Ste. 130, Carrollton, TX USA 75006 | Ph: +1 972 323 2200  
www.ttelectronics.com | sensors@ttelectronics.com

# High-Intensity LED in Plastic T-1<sup>3/4</sup> Package



## OVLGx0CyB9 Series

### Typical Electro-Optical Characteristics Curves—Red & Yellow

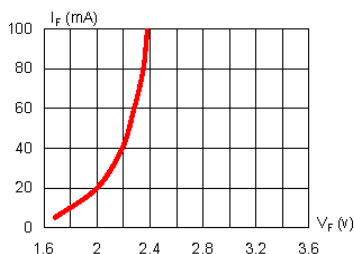

Fig.1 Forward Current vs. Forward Voltage

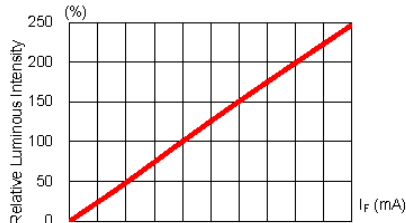

Fig.2 Luminous Intensity vs. Forward Current

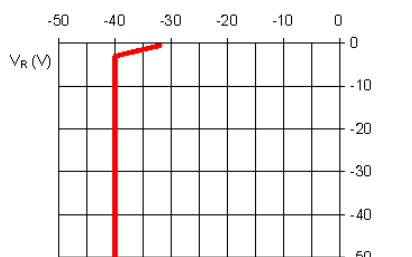

Fig.3 Reverse Current vs. Reverse Voltage



Fig.4 Allowable Forward Current vs. Ambient Temperature

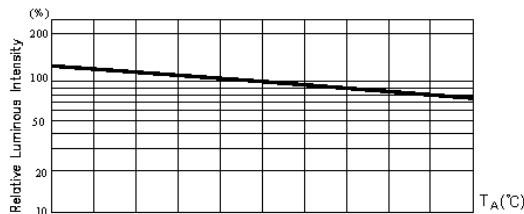

Fig.5 Luminous Intensity at I<sub>F</sub> = 20mA vs. Ambient Temperature

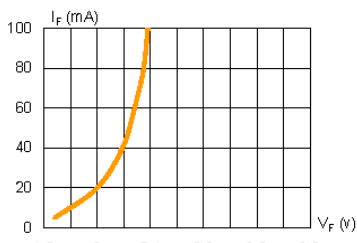

Fig.1 Forward Current vs. Forward Voltage

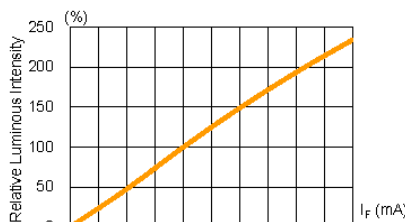

Fig.2 Luminous Intensity vs. Forward Current

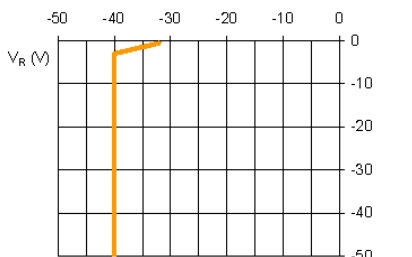

Fig.3 Reverse Current vs. Reverse Voltage

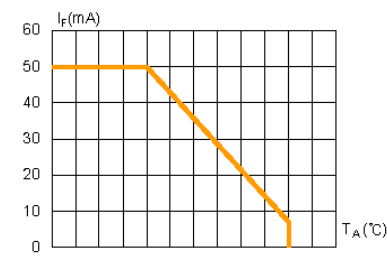

Fig.4 Allowable Forward Current vs. Ambient Temperature

#### General Note

TT Electronics reserves the right to make changes in product specification without notice or liability. All information is subject to TT Electronics' own data and is considered accurate at time of going to print.

TT Electronics | Optek Technology, Inc.  
1645 Wallace Drive, Ste. 130, Carrollton, TX USA 75006 | Ph: +1 972 323 2200  
www.ttelectronics.com | sensors@ttelectronics.com

# High-Intensity LED in Plastic T-1<sup>3</sup>/<sub>4</sub> Package



## OVLGx0CyB9 Series

Beam Angle:

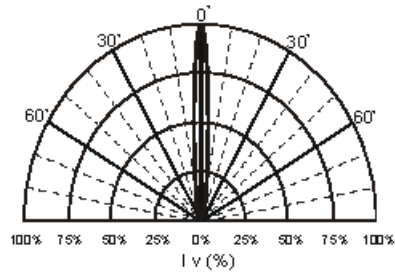

Packaging: 500 pcs per anti-static bag with desiccant

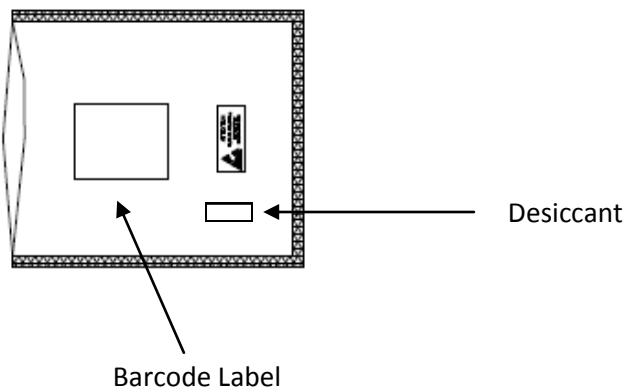

# High-Intensity LED in Plastic T-1<sup>3/4</sup> Package



## OVLGx0CyB9 Series

### Reliability Test

LED lamps are checked by reliability tests based on MIL standards.

#### 1. Test Conditions, Acceptable Criteria & Results

Classification	Test Item	Std. Test Method	Test Conditions	Duration	Unit	Acc / Rej Criteria	Result
Life Test	Operation Life Test (OLT)	MIL-STD-750D Method 1026.3	T <sub>A</sub> =25°C , I <sub>F</sub> =30mA *	1000 Hrs	100	0 / 1	Pass
Environmental Test	High Temperature Storage (HTS)	MIL-STD-750D Method 1032.1	T <sub>A</sub> =100°C	1000 Hrs	100	0 / 1	Pass
	Low Temperature Storage (LTS)	MIL-STD-750D Method 1032.1	T <sub>A</sub> =-40°C	1000 Hrs	100	0 / 1	Pass
	Temp. & Humidity with Bias (THB)	MIL-STD-750D Method 103B	T <sub>A</sub> =85°C , Rh=85% I <sub>F</sub> =20mA	500 Hrs	100	0 / 1	Pass
	Thermal Shock Test (TST)	MIL-STD-750D Method 1056.1	0°C ~ 100°C 2min 2min	100 cycles	100	0 / 1	Pass
	Temperature Cycling Test (TCT)	MIL-STD-750D Method 1051.5	-40°C ~ 25°C ~ 100°C ~ 25°C 30min 5min 30min 5min	100 cycles	100	0 / 1	Pass
Mechanical Test	Solderability	MIL-STD-750D Method 2026.4	235±5°C , 5 sec.	1 time	20	0 / 1	Pass
	Resistance to Soldering Heat	MIL-STD-750D Method 2031.1	260±5°C , 5 sec.	1 time	20	0 / 1	Pass
	Lead Integrity	MIL-STD-750D Method 2036.3	Load 2.5N (0.25kgf) 0°~90°~0° , bend	3 times	20	0 / 1	Pass

Remark: ( \* ) I<sub>F</sub> = 30mA for AllnGaP chip; I<sub>F</sub> = 20mA for InGan chip  
( \*\* ) I<sub>F</sub> = 20mA for AllnGaP chip; I<sub>F</sub> = 10mA for InGan chip

#### 2. Failure Criteria (T<sub>A</sub> = 25°C):

Test Item	Symbol	Test Conditions	Criteria for Judgment	
			Min.	Max
Luminous Intensity	I <sub>V</sub>	I <sub>F</sub> = 20mA	LSLx0.7 **	
Forward Voltage	V <sub>F</sub>	I <sub>F</sub> = 20mA		USLx1.1 *

( \* ) USL: Upper Standard Level, ( \*\* ) LSL: Lower Standard Level