

## DESCRIPTION

The EV8764GLE-L-00A is an evaluation board for the MP8764GLE, a high efficiency monolithic synchronous step-down converter.

The EV board can deliver 12A continuous load current over a wide 4.5V to 18V operating input range. High efficiency can be achieved over a wide output current load range.

Constant-On-Time (COT) control mode provides fast transient response and eases loop stabilization.

This EV board can be turned on or shut down via a remote ON/OFF input that is referenced to ground. This input is compatible with popular logic devices.

## ELECTRICAL SPECIFICATION

Parameter	Symbol	Value	Units
Input Voltage	$V_{IN}$	4.5 – 18	V
Output Voltage	$V_{OUT}$	3	V
Output Current	$I_{OUT}$	12	A

## FEATURES

- Wide 4.5V to 18V Operating Input Range
- 12A Output Current
- Low  $R_{DS(ON)}$  Internal Power MOSFETs
- Proprietary Switching Loss Reduction Technique
- Adaptive COT for Ultrafast Transient Response
- Programmable Soft Start Time
- Pre-Bias Start up
- Programmable Switching Frequency from 200kHz to 1MHz
- Latch-off SCP, and non-latch OVP Protection and Thermal Shutdown
- Output Adjustable from 0.611V to 13V
- Available in a QFN3x4 Package

## APPLICATIONS

- Set-top Boxes
- XDSL Modem/DSLAM
- Samll-cell Base Stations
- Personal Video Recorders
- Flat Panel Television and Monitors
- Distributed Power Systems

All MPS parts are lead-free and adhere to the RoHS directive. For MPS green status, please visit MPS website under Products, Quality Assurance page. "MPS" and "The Future of Analog IC Technology" are registered trademarks of Monolithic Power Systems, Inc.

## EV8764GLE-L-00A EVALUATION BOARD



(L x W x H) 85.5 mm x 85.5mm x 1.6 mm)

Board Number	MPS IC Number
EV8764GLE-L-00A	MP8764GLE

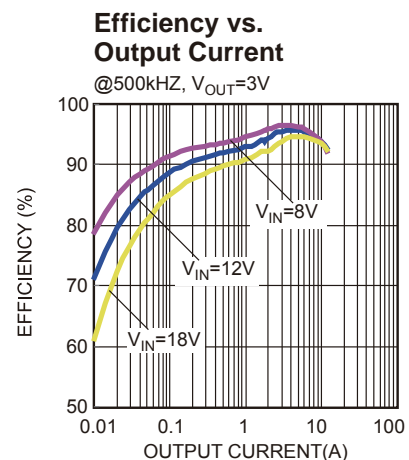



**EV8764GLE-L-00A BILL OF MATERIALS**

Qty	Ref	Value	Description	Package	Manufacture	Part Number
2	C1A, C1B	22 $\mu$ F	Ceramic Capacitor; 25V;X7R;1210;	1210	muRata	GRM32ER61E226M
4	C1C, C1D, C2E, C3	0.1 $\mu$ F	Ceramic Capacitor; 50V;X7R;0603	0603	muRata	GRM188R71H104KA93D
0	C2A	NS		POSCAP		
3	C2B, C2C, C2D	47 $\mu$ F	Ceramic Capacitor; 6.3V;X5R;1206	1206	TDK	C3216X5R0J476M
1	C4	100pF	Ceramic Capacitor; 50V;X7R;0603	0603	muRata	GRM1885C1H101JA01D
1	C5	1 $\mu$ F	Capacitor;25V;X7R	0603	muRata	GRM188R71E105KA12
1	C6	220nF	Ceramic Capacitor; 25V;X7R;0603	0603	muRata	GRM188R71E223JA01D
0	C7, C8, R8	NS		0603		
1	L1	1 $\mu$ H	Inductor;1 $\mu$ H; 1.35mOhm;32A	SMD	Würth	7443330100
1	R1	40.2k	Film Resistor;1%	0603	Yageo	RC0603FR-0740K2L
1	R2	10K	Film Resistor;1%;	0603	Yageo	RC0603FR-0710KL
1	R3	4.7 $\Omega$	Film Resistor;5%	0603	Yageo	RC0603JR-074R7L
2	R4, R7	1M	Film Resistor;5%;	0603	Yageo	RC0603JR-071ML
1	R5	499k	Film Resistor;1%	0603	Yageo	RC0603FR-07499KL
1	R6	100k	Film Resistor;1%;	0603	Yageo	RC0603FR-07100KL
1	R9	2k	Film Resistor;1%;	0603	Yageo	RC0603FR-072KL
1	U1		Step Down Converter	QFN 3X4	MPS	MP8764GLE

## EVB TEST RESULTS

Performance waveforms are tested on the EV8764GLE-L-00A evaluation board.

$V_{IN} = 12V$ ,  $V_{OUT} = 3V$ ,  $L = 1\mu H$ ,  $T_A = +25^\circ C$ , unless otherwise noted.

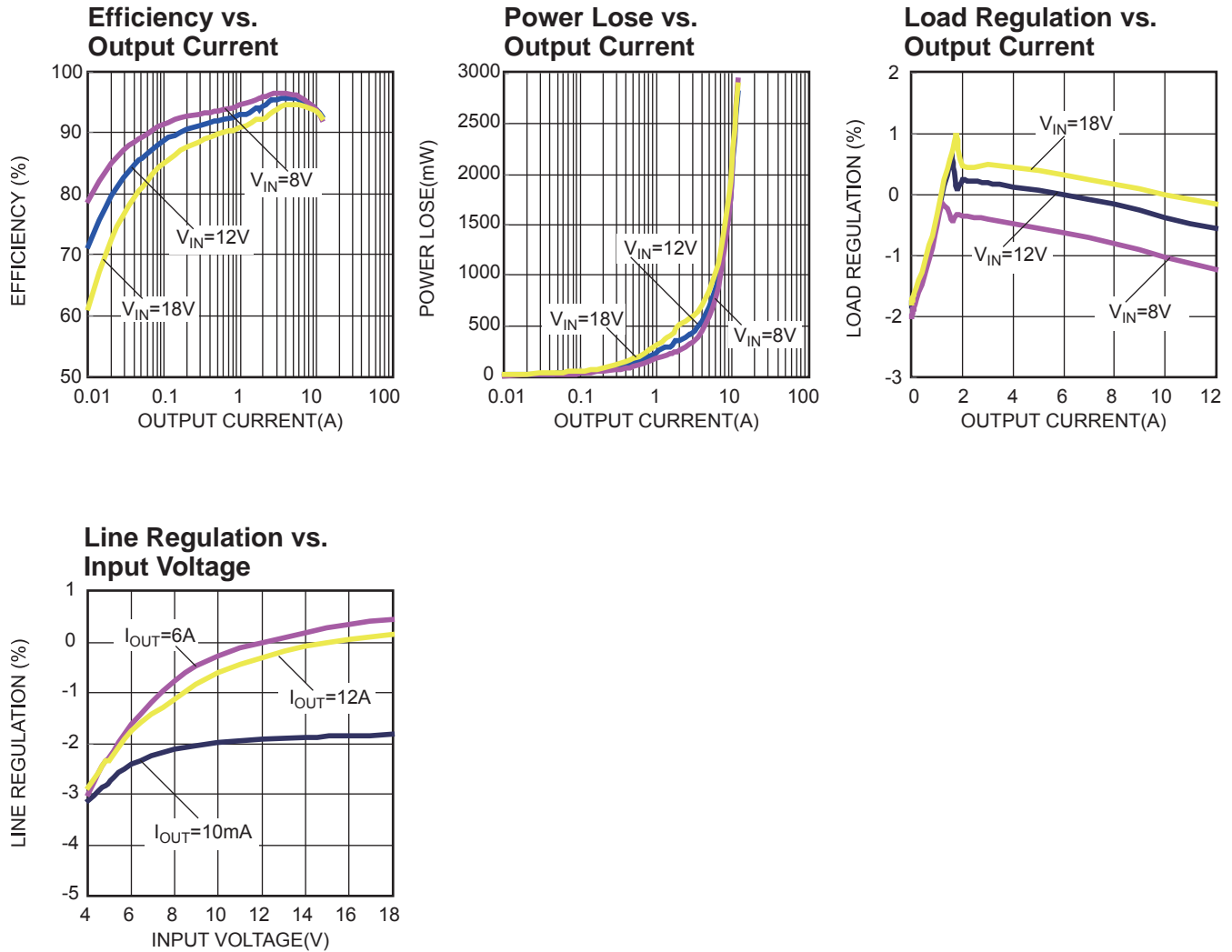

**EVB TEST RESULTS (continued)**

Performance waveforms are tested on the EV8764GLE-L-00A evaluation board.

$V_{IN} = 12V$ ,  $V_{OUT} = 3V$ ,  $L = 1\mu H$ ,  $T_A = +25^\circ C$ , unless otherwise noted.

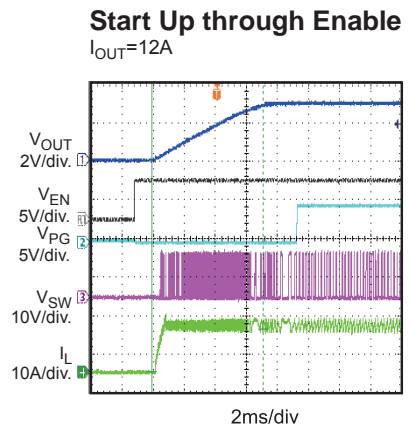
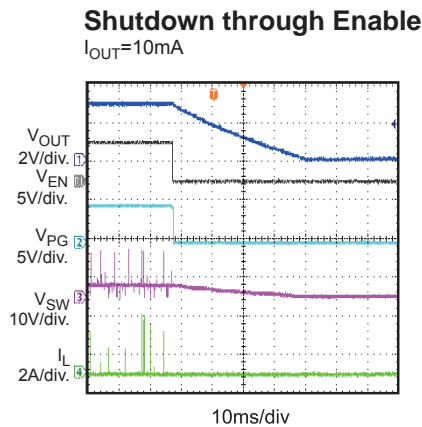
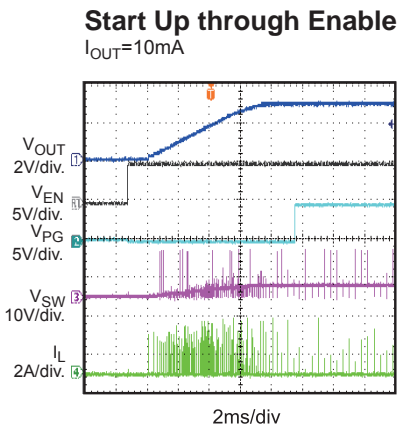
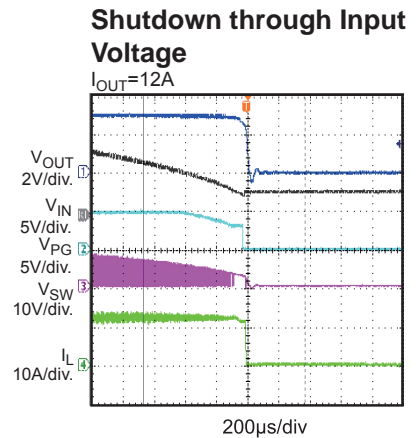
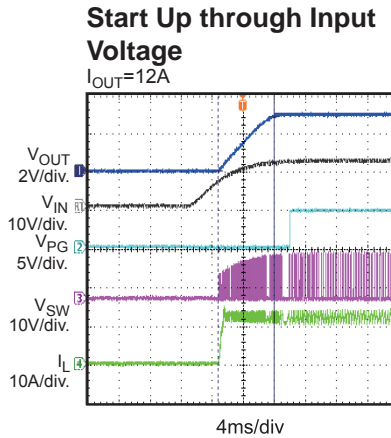
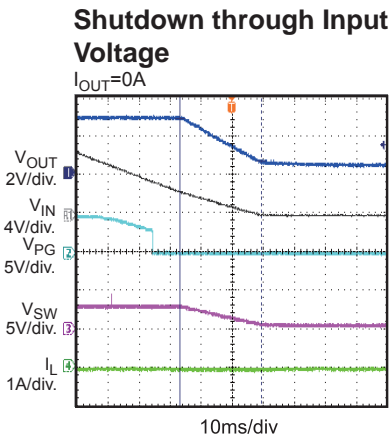
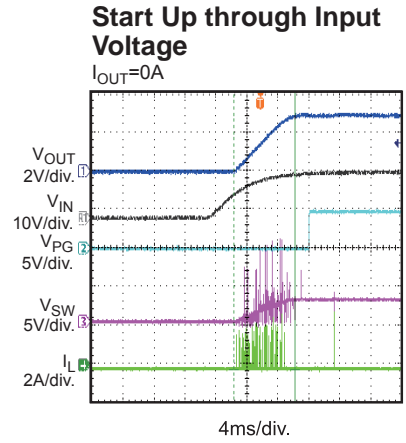
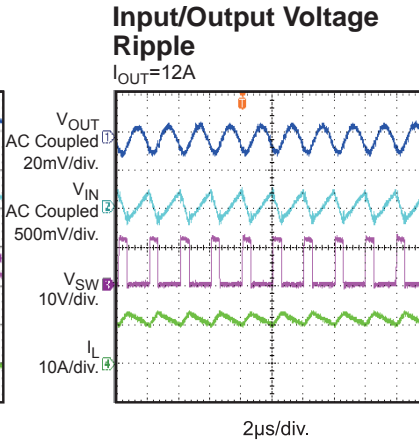
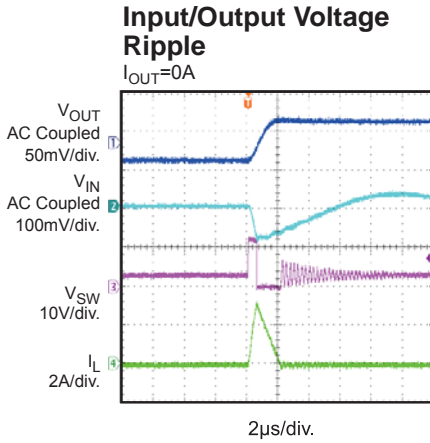

## EVB TEST RESULTS *(continued)*

Performance waveforms are tested on the EV8764GLE-L-00A evaluation board.

$V_{IN} = 12V$ ,  $V_{OUT} = 3V$ ,  $L = 1\mu H$ ,  $T_A = +25^\circ C$ , unless otherwise noted.

### Shutdown through Enable

$I_{OUT} = 12A$

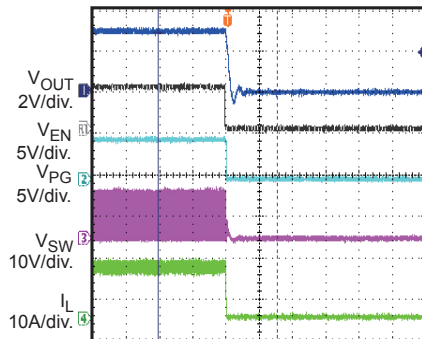

200 $\mu s$ /div.

### Transient Response

$I_{OUT} = 6A-12A, 2.5A/\mu s$

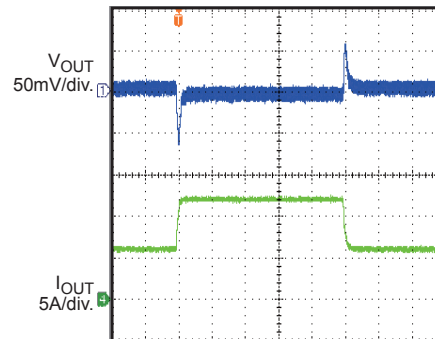

100 $\mu s$ /div.

### Short Circuit Protection

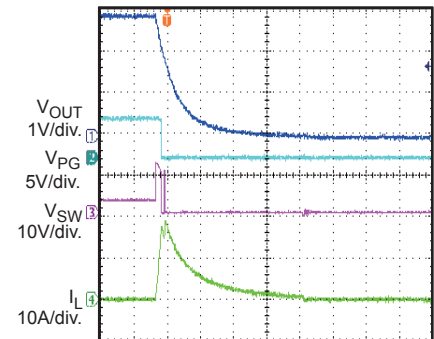

20 $\mu s$ /div.

### Thermal Shutdown

$I_{OUT} = 0A, V_{OUT} = 3V$

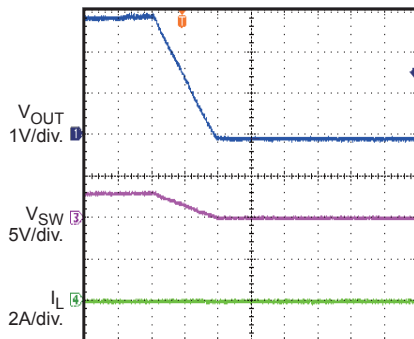

2s/div

### Thermal Recovery

$I_{OUT} = 0A, V_{OUT} = 3V$

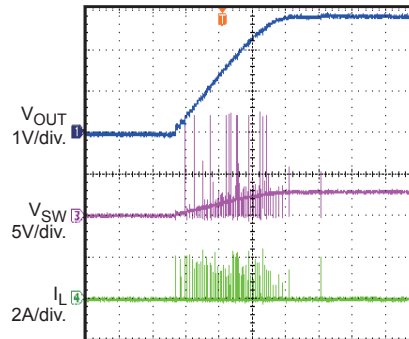

2ms/div

**PRINTED CIRCUIT BOARD LAYOUT**

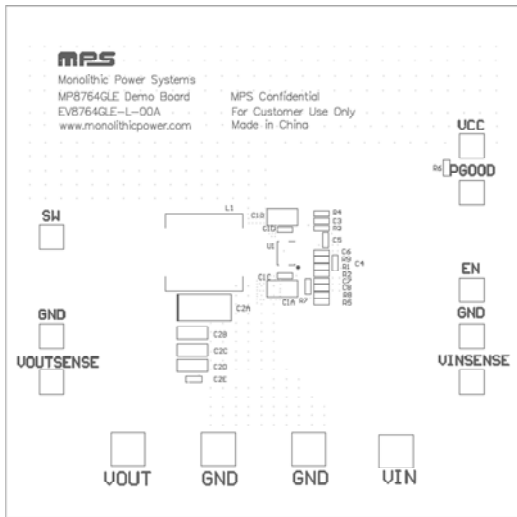

**Figure 1—Top Silk Layer**

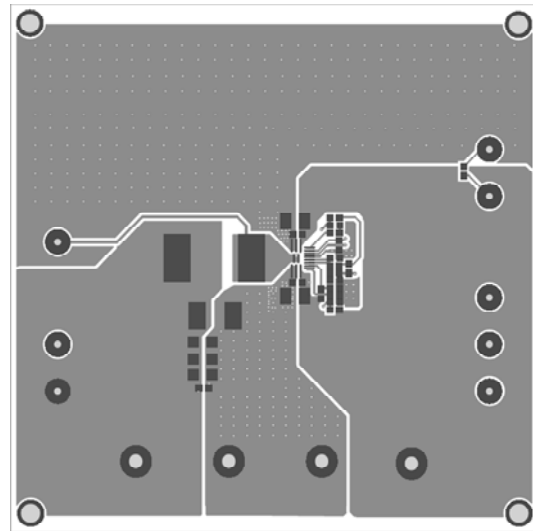

**Figure 2—Top Layer**

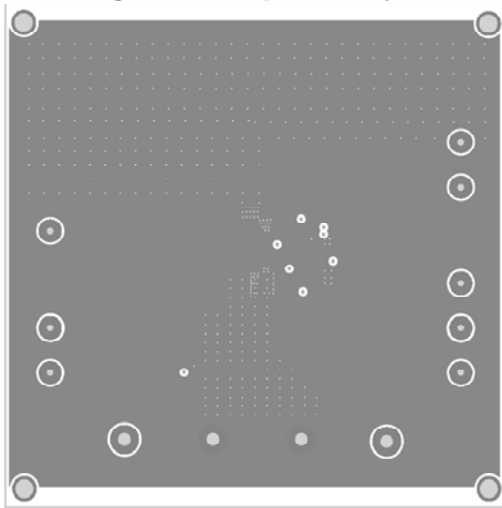

**Figure 3—Inner Layer 1**

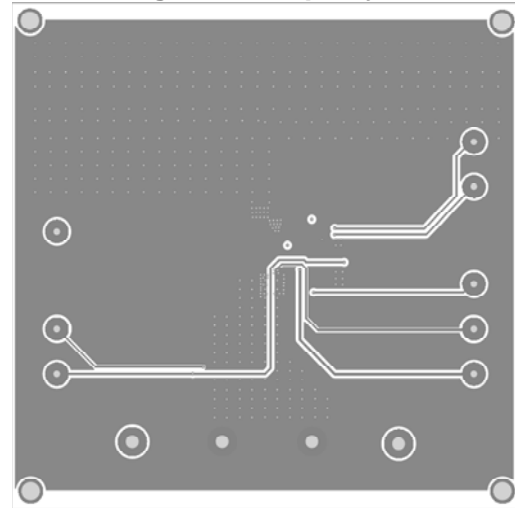

**Figure 4— Inner Layer 2**

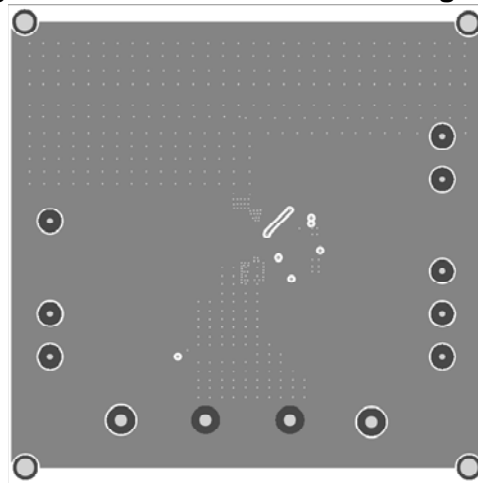

**Figure 5—Bottom Layer**

## QUICK START GUIDE

1. Connect the positive and negative terminals of the load to the VOUT and GND pins, respectively.
2. Preset the power supply output between 4.5V and 18V, and then turn off the power supply.
3. Connect the positive and negative terminals of the power supply output to the VIN and GND pins, respectively.
4. Turn the power supply on. The MP8764GLE will automatically startup.
5. To use the Enable function, apply a digital input to the EN pin. Drive EN higher than 2V to turn on the regulator or less than 0.4V to turn it off.
6. Use R1 and R2 to set the output voltage with  $V_{FB} = 0.611V$ . Follow the Application Information section in the device datasheet to select the proper value of R1, R2, inductor and output capacitor values when output voltage is changed.
7. If lower ripple at light loads is needed, then use 1.2 $\mu$ H or 1.5 $\mu$ H L1. But with the larger L1, the transient response peak to peak value will become larger too.

**NOTICE:** The information in this document is subject to change without notice. Please contact MPS for current specifications. Users should warrant and guarantee that third party Intellectual Property rights are not infringed upon when integrating MPS products into any application. MPS will not assume any legal responsibility for any said applications.