

### Features

- $S_{21} = 14.6 \text{ dB @ 2300 MHz}$   
=  $13.4 \text{ dB @ 2700 MHz}$
- NF of 0.8 dB over Frequency
- Unconditionally Stable
- Single 5V Supply
- High OIP3 @ Low Current

### Description

The plerow™ ALN-series is the compactly designed surface-mount module for the use of the LNA with or without the following gain blocks in the infrastructure equipment of the mobile wireless (CDMA, GSM, PCS, PHS, WCDMA, DMB, WLAN, WiBro, WiMAX), GPS, satellite communication terminals, CATV and so on. It has an exceptional performance of low noise figure, high gain, high OIP3, and low bias current. The stability factor is always kept more than unity over the application band in order to ensure its unconditionally stable implementation to the application system environment. The surface-mount module package including the completed matching circuit and other components necessary just in case allows very simple and convenient implementation onto the system board in mass production level.

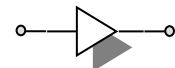

1-stage Single Type

### Specifications (in Production)

Typ. @  $T = 25^{\circ}\text{C}$ ,  $V_s = 5 \text{ V}$ , Freq. = 2500 MHz,  $Z_{o,\text{sys}} = 50 \text{ ohm}$

Parameter	Unit	Specifications		
		Min	Typ	Max
Frequency Range	MHz	2300		2700
Gain	dB	13	14	
Gain Flatness	dB		$\pm 0.6$	$\pm 0.8$
Noise Figure	dB		0.8	0.85
Output IP3 <sup>(1)</sup>	dBm	31	32	
S11 / S22 <sup>(2)</sup>	dB			-12 / -10
Output P1dB	dBm	17	18	
Switching Time <sup>(3)</sup>	$\mu\text{sec}$			1
Supply Current	mA		60	80
Supply Voltage	V		5	
Impedance	$\Omega$		50	
Package Type & Size	mm	Surface Mount Type, 10Wx10Lx3.8H		

### More Information

Website: [www.asb.co.kr](http://www.asb.co.kr)  
E-mail: [sales@asb.co.kr](mailto:sales@asb.co.kr)

Tel: (82) 42-528-7223  
Fax: (82) 42-528-7222

Operating temperature is  $-40^{\circ}\text{C}$  to  $+85^{\circ}\text{C}$ .

1) OIP3 is measured with two tones at an output power of 0 dBm / tone separated by 1 MHz.

2) S11/S22 (max) is the worst value within the frequency band.

3) Switching time means the time that takes for output power to get stabilized to its final level after switching DC voltage from 0 V to  $V_s$ .

### Outline Drawing (Unit: mm)

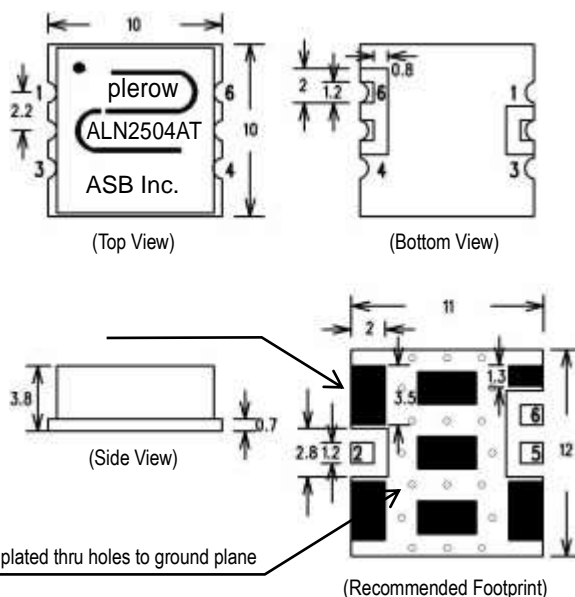

Pin Number	Function
2	RF In
5	RF Out
6	+Vcc
Others	Ground

Note: 1. The number and size of ground via holes in a circuit board is critical for thermal RF grounding considerations.

2. We recommend that the ground via holes be placed on the bottom of all ground pins for better RF and thermal performance, as shown in the drawing at the left side.

Typical Performance  
(Measured)

2300~2700 MHz  
+5 V

S-parameters

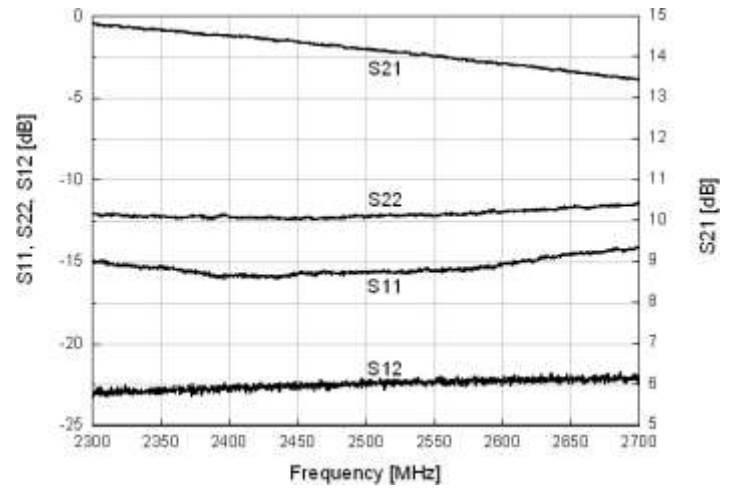

S-parameters & K Factor

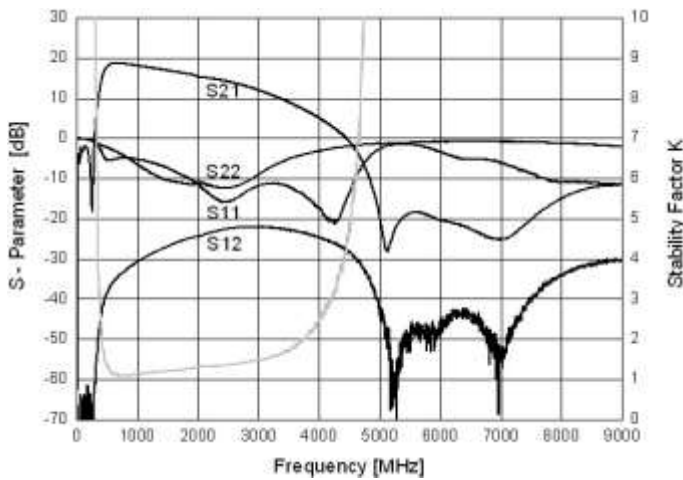

Noise Figure

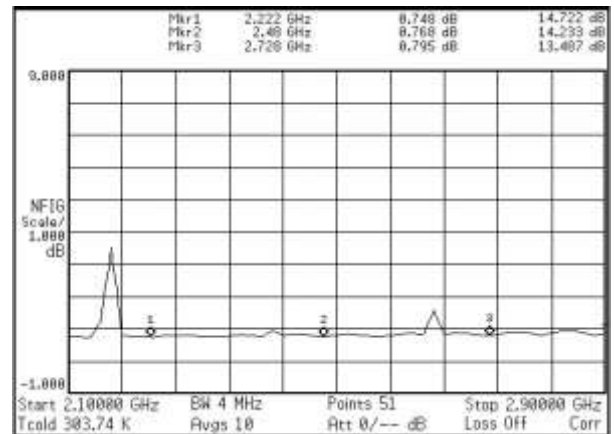

OIP3

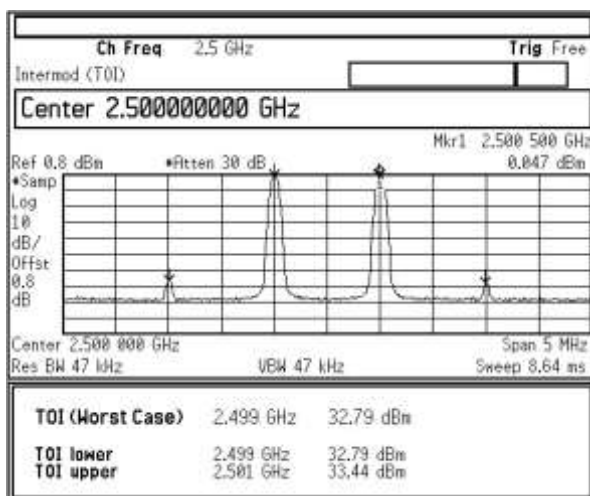

P1dB

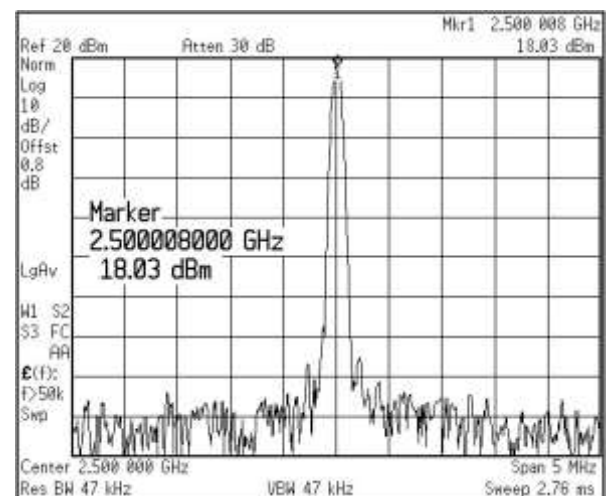

### RF Performance with Voltage Change

Item Voltage	S11 (dB)	S22 (dB)	S21 (dB)	G/F (dB)	NF (dB)	P1dB (dBm)	OIP3 (dBm)	Current (mA)
4.5	-13.19	-12.21	14.01	0.99	0.778	16.95	32.70	53
4.6	-13.24	-12.19	14.05	0.98	0.779	17.14	32.94	55
4.7	-13.33	-12.14	14.09	0.98	0.787	17.36	33.19	57
4.8	-13.39	-12.09	14.12	0.97	0.795	17.55	33.24	60
4.9	-13.41	-11.95	14.14	0.97	0.798	17.74	32.88	62
5.0	<b>-13.48</b>	<b>-11.94</b>	<b>14.15</b>	<b>0.96</b>	<b>0.800</b>	<b>17.92</b>	<b>32.69</b>	<b>64</b>
5.1	-13.50	-11.84	14.17	0.96	0.802	18.05	32.50	66
5.2	-13.55	-11.78	14.20	0.95	0.814	18.26	32.05	68
5.3	-13.59	-11.69	14.22	0.95	0.825	18.41	31.78	70
5.4	-13.62	-11.60	14.23	0.95	0.834	18.56	31.59	72
5.5	-13.64	-11.52	14.24	0.95	0.840	18.71	31.26	73

### RF Performance with Operating Temperature

Item Temp.	S11 (dB)	S22 (dB)	S21 (dB)	G/F (dB)	NF (dB)	P1dB (dBm)	OIP3 (dBm)	Current (mA)
-40°C	-13.61	-10.17	15.25	0.90	0.489	17.99	29.43	61
-20°C	-13.67	-10.63	15.08	0.93	0.617	17.99	31.44	63
0°C	-13.74	-10.73	14.94	0.93	0.706	17.94	32.47	63
25°C	<b>-13.72</b>	<b>-10.63</b>	<b>14.80</b>	<b>0.94</b>	<b>0.807</b>	<b>17.88</b>	<b>32.79</b>	<b>64</b>
40°C	-13.68	-10.51	14.72	0.94	0.889	17.73	32.17	64
60°C	-13.67	-10.38	14.52	0.94	1.014	17.42	30.78	64
80°C	-13.68	-10.16	14.41	0.95	1.107	17.12	30.42	62
100°C	-13.67	-9.95	14.25	0.95	1.249	16.65	29.04	61

## Application Circuit

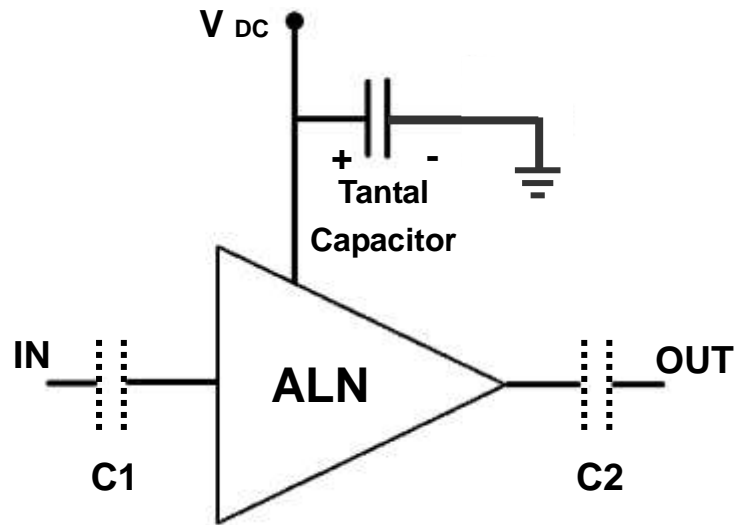

- 1) The tantal capacitor is optional and for bypassing the AC noise introduced from the DC supply. The capacitance value may be determined by customer's DC supply status.
- 2) So-called DC blocking capacitors are always necessarily placed at the input and output port for allowing only the RF signal to pass and blocking the DC component in the signal. The DC blocking capacitors are included inside the LNA module. Therefore, C1 & C2 capacitors may not be necessary, but can be added just in case that the customer wants. The value of C1 & C2 is determined by considering the application frequency.

## Recommended Soldering Reflow Process

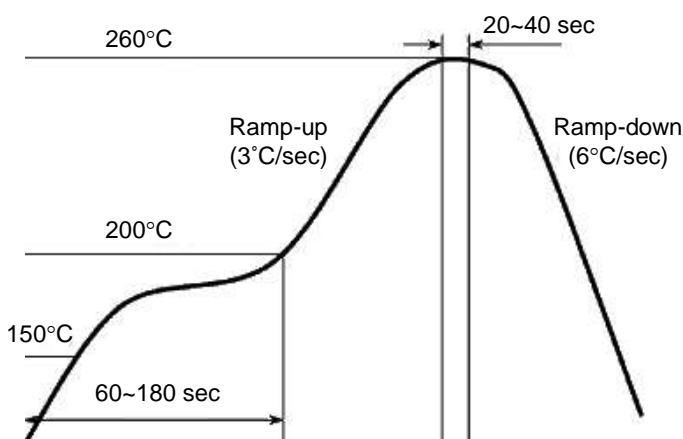

## Evaluation Board Layout

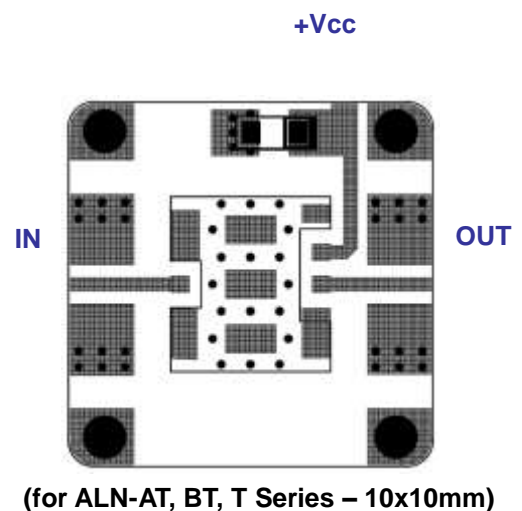

Copyright ©2008-2017 ASB Inc. All rights reserved. Datasheet subject to change without notice. ASB assumes no responsibility for any errors which may appear in this datasheet. No part of the datasheet may be copied or reproduced in any form or by any means without the prior written consent of ASB.