

## SNx4HC14 Hex Schmitt-Trigger Inverters

### 1 Features

- Wide Operating Voltage Range of 2 V to 6 V
- Outputs Can Drive Up to 10 LSTTL Loads
- Low Power Consumption, 20- $\mu$ A Max  $I_{CC}$
- Typical  $t_{pd} = 11$  ns
- $\pm 4$ -mA Output Drive at 5 V
- Low Input Current of 1  $\mu$ A Max
- On Products Compliant to MIL-PRF-38535, All Parameters Are Tested Unless Otherwise Noted. On All Other Products, Production Processing Does Not Necessarily Include Testing of All Parameters.

### 2 Applications

- Microwave Oven
- Mice
- Printers
- AC Inverter Drives
- UPS
- AC Servo Drives
- Other Motor Drives

### 3 Description

These Schmitt-trigger devices contain six independent inverters. They perform the Boolean function  $Y = \bar{A}$  in positive logic.

#### Device Information<sup>(1)</sup>

PART NUMBER	PACKAGE	BODY SIZE (NOM)
SNx4HC14	CDIP (14)	7.62 mm x 19.94 mm
	CFP (14)	7.11 mm x 9.11 mm
	LCCC (20)	8.89 mm x 8.89 mm
	SOIC (14)	6.00 mm x 8.65 mm
	SSOP (14)	367.00 mm x 367.00 mm
	PDIP (14)	7.94 mm x 10.35 mm
	SO (14)	7.80 mm x 10.20 mm
	TSSOP (14)	6.40 mm x 5.00 mm

(1) For all available packages, see the orderable addendum at the end of the data sheet.

#### Logic Diagram (Positive Logic)

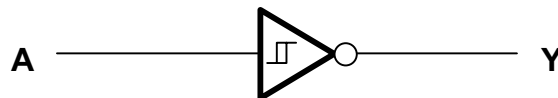

## Table of Contents

<b>1 Features</b> .....	<b>1</b>	9.2 Functional Block Diagram .....	<b>9</b>
<b>2 Applications</b> .....	<b>1</b>	9.3 Feature Description .....	<b>9</b>
<b>3 Description</b> .....	<b>1</b>	9.4 Device Functional Modes .....	<b>9</b>
<b>4 Revision History</b> .....	<b>2</b>	<b>10 Application and Implementation</b> .....	<b>10</b>
<b>5 Device Comparison Table</b> .....	<b>3</b>	10.1 Application Information .....	<b>10</b>
<b>6 Pin Configuration and Functions</b> .....	<b>4</b>	10.2 Typical Application .....	<b>10</b>
<b>7 Specifications</b> .....	<b>5</b>	<b>11 Power Supply Recommendations</b> .....	<b>11</b>
7.1 Absolute Maximum Ratings .....	<b>5</b>	<b>12 Layout</b> .....	<b>12</b>
7.2 ESD Ratings .....	<b>5</b>	12.1 Layout Guidelines .....	<b>12</b>
7.3 Recommended Operating Conditions .....	<b>5</b>	12.2 Layout Example .....	<b>12</b>
7.4 Thermal Information .....	<b>5</b>	<b>13 Device and Documentation Support</b> .....	<b>13</b>
7.5 Electrical Characteristics .....	<b>6</b>	13.1 Documentation Support .....	<b>13</b>
7.6 Switching Characteristics .....	<b>6</b>	13.2 Related Links .....	<b>13</b>
7.7 Operating Characteristics .....	<b>6</b>	13.3 Community Resources .....	<b>13</b>
7.8 Typical Characteristics .....	<b>7</b>	13.4 Trademarks .....	<b>13</b>
<b>8 Parameter Measurement Information</b> .....	<b>8</b>	13.5 Electrostatic Discharge Caution .....	<b>13</b>
<b>9 Detailed Description</b> .....	<b>9</b>	13.6 Glossary .....	<b>13</b>
9.1 Overview .....	<b>9</b>	<b>14 Mechanical, Packaging, and Orderable Information</b> .....	<b>13</b>

## 4 Revision History

NOTE: Page numbers for previous revisions may differ from page numbers in the current version.

<b>Changes from Revision H (September 2015) to Revision I</b>	<b>Page</b>
• Changed part number from SN54HC08 to SN54HC14 in <i>Switching Characteristics</i> table .....	<b>6</b>
• Changed part number from SN74HC08 to SN74HC14 in <i>Switching Characteristics</i> table .....	<b>6</b>

<b>Changes from Revision G (January 2014) to Revision H</b>	<b>Page</b>
• Added <i>Pin Configuration and Functions</i> section, <i>ESD Ratings</i> table, <i>Feature Description</i> section, <i>Device Functional Modes</i> , <i>Application and Implementation</i> section, <i>Power Supply Recommendations</i> section, <i>Layout</i> section, <i>Device and Documentation Support</i> section, and <i>Mechanical, Packaging, and Orderable Information</i> section .....	<b>1</b>
• Added Military Disclaimer to <i>Features</i> list .....	<b>1</b>
• Added <i>Applications</i> .....	<b>1</b>

<b>Changes from Revision F (December 2010) to Revision G</b>	<b>Page</b>
• Updated document to new TI data sheet format - no specification changes .....	<b>1</b>

## 5 Device Comparison Table

PART NUMBER	PACKAGE	BODY SIZE (NOM)
SN54HC14J	CDIP (14)	7.62 mm x 19.94 mm
SNJ54HC14W	CFP (14)	7.11 mm x 9.11 mm
SNJ54HC14FK	LCCC (20)	8.89 mm x 8.89 mm
SN74HC14DR	SOIC (14)	6.00 mm x 8.65 mm
SN74HC14DBR	SSOP (14)	367.00 mm x 367.00 mm
SN74HC14N	PDIP (14)	7.94 mm x 10.35 mm
SN74HC14NSR	SO (14)	7.80 mm x 10.20 mm
SN74HC14PW	TSSOP (14)	6.40 mm x 5.00 mm

# SN54HC14, SN74HC14

SCLS085I – DECEMBER 1982 – REVISED FEBRUARY 2016

www.ti.com

## 6 Pin Configuration and Functions

J, W, D, DB, N, NS, or PW Package  
14-Pin CDIP, CFP, SOIC, SSOP, SO, or TSSOP  
Top View

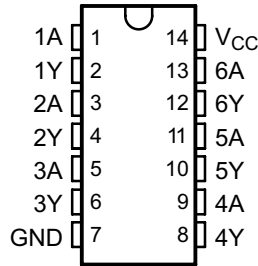

FK Package  
20-Pin LCCC  
Top View

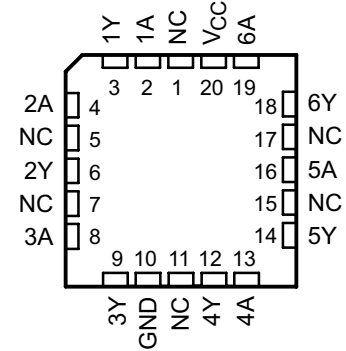

### Pin Functions

NAME	PIN		I/O	DESCRIPTION
	CDIP, CFP, SOIC, SSOP, SO, TSSOP	LCCC		
1A	1	2	I	Channel 1 input
1Y	2	3	O	Channel 1 output
2A	3	4	I	Channel 2 input
2Y	4	6	O	Channel 2 output
3A	5	8	I	Channel 3 input
3Y	6	9	O	Channel 3 output
GND	7	10	—	Ground
4Y	8	12	O	Channel 4 output
4A	9	13	I	Channel 4 input
5Y	10	14	O	Channel 5 output
5A	11	16	I	Channel 5 input
6Y	12	18	O	Channel 6 output
6A	13	19	I	Channel 6 input
V <sub>CC</sub>	14	20	—	Power supply
NC <sup>(1)</sup>	—	1	—	No internal connection
		5		
		7		
		11		
		15		
		17		

(1) NC – No internal connection

## 7 Specifications

### 7.1 Absolute Maximum Ratings

over operating free-air temperature range (unless otherwise noted)<sup>(1)</sup>

		MIN	MAX	UNIT
V <sub>CC</sub>	Supply voltage	-0.5	7	V
I <sub>IK</sub>	Input clamp current <sup>(2)</sup>	V <sub>I</sub> < 0 or V <sub>I</sub> > V <sub>CC</sub>		±20 mA
I <sub>OK</sub>	Output clamp current <sup>(2)</sup>	V <sub>O</sub> < 0		±20 mA
I <sub>O</sub>	Continuous output current	V <sub>O</sub> = 0 to V <sub>CC</sub>		±25 mA
	Continuous current through V <sub>CC</sub> or GND			±50 mA
T <sub>j</sub>	Junction temperature			150 °C
T <sub>stg</sub>	Storage temperature	-65	150	

- (1) Stresses beyond those listed under *Absolute Maximum Ratings* may cause permanent damage to the device. These are stress ratings only, and functional operation of the device at these or any other conditions beyond those indicated under *Recommended Operating Conditions* is not implied. Exposure to absolute-maximum-rated conditions for extended periods may affect device reliability.
- (2) The input and output voltage ratings may be exceeded if the input and output current ratings are observed.

### 7.2 ESD Ratings

		VALUE	UNIT
V <sub>(ESD)</sub>	Electrostatic discharge	Human body model (HBM), per ANSI/ESDA/JEDEC JS-001 <sup>(1)</sup>	±2000
		Charged-device model (CDM), per JEDEC specification JESD22-C101 <sup>(2)</sup>	±1500

- (1) JEDEC document JEP155 states that 500-V HBM allows safe manufacturing with a standard ESD control process.
- (2) JEDEC document JEP157 states that 250-V CDM allows safe manufacturing with a standard ESD control process.

### 7.3 Recommended Operating Conditions

See <sup>(1)</sup>.

		SN54HC14			SN74HC14			UNIT
		MIN	NOM	MAX	MIN	NOM	MAX	
V <sub>CC</sub>	Supply voltage	2	5	6	2	5	6	V
V <sub>I</sub>	Input voltage	0		V <sub>CC</sub>	0		V <sub>CC</sub>	V
V <sub>O</sub>	Output voltage	0		V <sub>CC</sub>	0		V <sub>CC</sub>	V
T <sub>A</sub>	Operating free-air temperature	-55		125	-40		85	°C

- (1) All unused inputs of the device must be held at V<sub>CC</sub> or GND to ensure proper device operation. Refer to the TI application report, *Implications of Slow or Floating CMOS Inputs*, [SCBA004](#).

### 7.4 Thermal Information

THERMAL METRIC <sup>(1)</sup>	SNx4HC14					UNIT	
	D (SOIC)	DB (SSOP)	N (PDIP)	NS (SO)	PW (TSSOP)		
	14 PINS	14 PINS	14 PINS	14 PINS	14 PINS		
R <sub>θJA</sub>	Junction-to-ambient thermal resistance	86	96	80	76	113	°C/W

- (1) For more information about traditional and new thermal metrics, see the *Semiconductor and IC Package Thermal Metrics* application report, [SPRA953](#).

## SN54HC14, SN74HC14

SCLS085I – DECEMBER 1982 – REVISED FEBRUARY 2016

www.ti.com

### 7.5 Electrical Characteristics

over operating free-air temperature range (unless otherwise noted)

PARAMETER	TEST CONDITIONS		V <sub>CC</sub>	T <sub>A</sub> = 25°C			SN54HC14		SN74HC14		UNIT		
				MIN	TYP	MAX	MIN	MAX	MIN	MAX			
V <sub>T+</sub>			2 V	0.7	1.2	1.5	0.7	1.5	0.7	1.5	V		
			4.5 V	1.55	2.5	3.15	1.55	3.15	1.55	3.15			
			6 V	2.1	3.3	4.2	2.1	4.2	2.1	4.2			
V <sub>T-</sub>			2 V	0.3	0.6	1	0.3	1	0.3	1	V		
			4.5 V	0.9	1.6	2.45	0.9	2.45	0.9	2.45			
			6 V	1.2	2	3.2	1.2	3.2	1.2	3.2			
V <sub>T+</sub> - V <sub>T-</sub>			2 V	0.2	0.6	1.2	0.2	1.2	0.2	1.2	V		
			4.5 V	0.4	0.9	2.1	0.4	2.1	0.4	2.1			
			6 V	0.5	1.3	2.5	0.5	2.5	0.5	2.5			
V <sub>OH</sub>	V <sub>I</sub> = V <sub>IH</sub> or V <sub>IL</sub>	I <sub>OH</sub> = -20 μA	2 V	1.9	1.998		1.9		1.9	V			
			4.5 V	4.4	4.499		4.4		4.4				
			6 V	5.9	5.999		5.9		5.9				
		I <sub>OH</sub> = -4 mA	4.5 V	3.98	4.3		3.7		3.84				
		I <sub>OH</sub> = -5.2 mA	6 V	5.48	5.8		5.2		5.34				
V <sub>OL</sub>	V <sub>I</sub> = V <sub>IH</sub> or V <sub>IL</sub>	I <sub>OL</sub> = 20 μA	2 V		0.002	0.1		0.1		0.1	V		
			4.5 V		0.001	0.1		0.1		0.1			
			6 V		0.001	0.1		0.1		0.1			
		I <sub>OL</sub> = 4 mA	4.5 V		0.17	0.26		0.4		0.33			
		I <sub>OL</sub> = 5.2 mA	6 V		0.15	0.26		0.4		0.33			
I <sub>I</sub>	V <sub>I</sub> = V <sub>CC</sub> or 0		6 V		±0.1	±100		±1000		±1000	nA		
I <sub>CC</sub>	V <sub>I</sub> = V <sub>CC</sub> or 0, I <sub>O</sub> = 0		6 V					2		40	20	μA	
C <sub>i</sub>			2 V to 6 V			3				10		10	pF

### 7.6 Switching Characteristics

over operating free-air temperature range, C<sub>L</sub> = 50 pF (unless otherwise noted) (see Figure 3)

PARAMETER	FROM (INPUT)	TO (OUTPUT)	V <sub>CC</sub>	T <sub>A</sub> = 25°C			SN54HC14		SN74HC14		UNIT
				MIN	TYP	MAX	MIN	MAX	MIN	MAX	
t <sub>pd</sub>	A	Y	2 V		55	125		190		155	ns
			4.5 V		12	25		38		31	
			6 V		11	21		22		26	
t <sub>t</sub>		Y	2 V		38	75		110		95	ns
			4.5 V		8	15		22		19	
			6 V		6	13		19		16	

### 7.7 Operating Characteristics

T<sub>A</sub> = 25°C

PARAMETER	TEST CONDITIONS	TYP	UNIT
C <sub>pd</sub>	Power dissipation capacitance per inverter No load	20	pF

## 7.8 Typical Characteristics

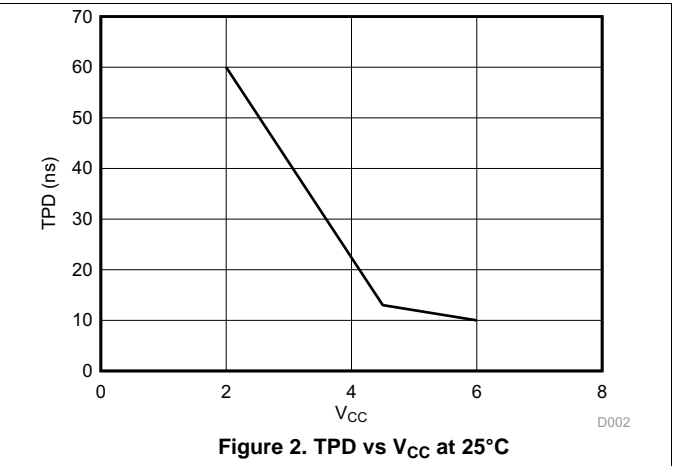
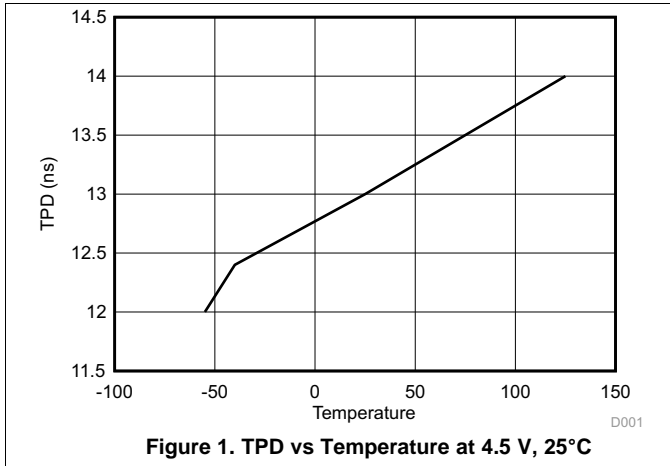

## 8 Parameter Measurement Information

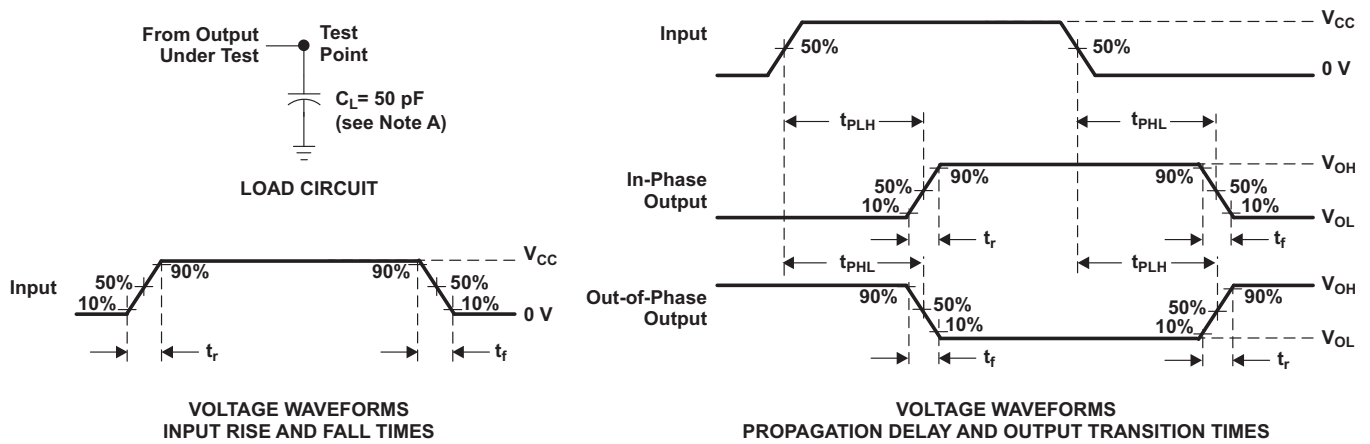

**Figure 3. Load Circuit and Voltage Waveforms**



## 9 Detailed Description

### 9.1 Overview

These Schmitt-trigger devices contain six independent inverters. They perform the Boolean function  $Y = \overline{A}$  in positive logic.

Schmitt-trigger inputs are designed to provide a minimum separation between positive and negative switching thresholds. This allows for noisy or slow inputs that would cause problems such as oscillation or excessive current draw with normal CMOS inputs.

### 9.2 Functional Block Diagram



**Figure 4. Logic Diagram (Positive Logic)**

### 9.3 Feature Description

The wide operating range of the device allows it to be used in a variety of systems that use different logic levels. The outputs can drive up to 10 LSTTL loads each. The device has very low power consumption, with 20- $\mu$ A Max  $I_{CC}$ . Typical propagation delay is also low at 11 ns. The balanced drive outputs can source or sink 4 mA at 5-V  $V_{CC}$ . The input leakage current is 1  $\mu$ A Max.

### 9.4 Device Functional Modes

Table 1 lists the functional modes of the SNx4HC14.

**Table 1. Function Table (Each Inverter)**

INPUTS A	OUTPUT Y
H	L
L	H

## 10 Application and Implementation

### NOTE

Information in the following applications sections is not part of the TI component specification, and TI does not warrant its accuracy or completeness. TI's customers are responsible for determining suitability of components for their purposes. Customers should validate and test their design implementation to confirm system functionality.

### 10.1 Application Information

The SNx4HC14 device is a Schmitt-trigger input CMOS device that can be used for a multitude of inverting buffer type functions. The application shown here takes advantage of the Schmitt-trigger inputs to produce a delay for a logic output.

### 10.2 Typical Application

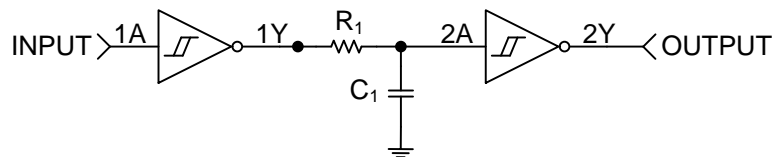

**Figure 5. Simplified Application Schematic**

#### 10.2.1 Design Requirements

This device uses CMOS technology. Take care to avoid bus contention because it can drive currents that would exceed maximum limits. Parallel output drive can create fast edges into light loads so consider routing and load conditions to prevent ringing.

#### 10.2.2 Detailed Design Procedure

This circuit is designed around an RC network that produces a slow input to the second inverter. The RC time constant,  $\tau$ , is calculated from:  $\tau = R \times C$

The delay time for this circuit will be between  $1.2\tau$  and  $0.42\tau$ . It should be noted that the delay will be consistent for each device, but since the switching threshold is only guaranteed between a minimum and maximum value, the output pulse length will vary between devices. These values were calculated by using the minimum and maximum guaranteed  $V_{T+}$  values.

The resistor value should be chosen such that the maximum current from/to the SNx4HC14 is 4 mA.

- Recommended input conditions:
  - Schmitt-trigger inputs allow for slow inputs.
  - Specified high and low levels. See ( $V_{IH}$  and  $V_{IL}$ ) in [Recommended Operating Conditions](#).
- Recommended output conditions:
  - Load currents should not exceed 4 mA per output.

Typical Application (continued)

10.2.3 Application Curve

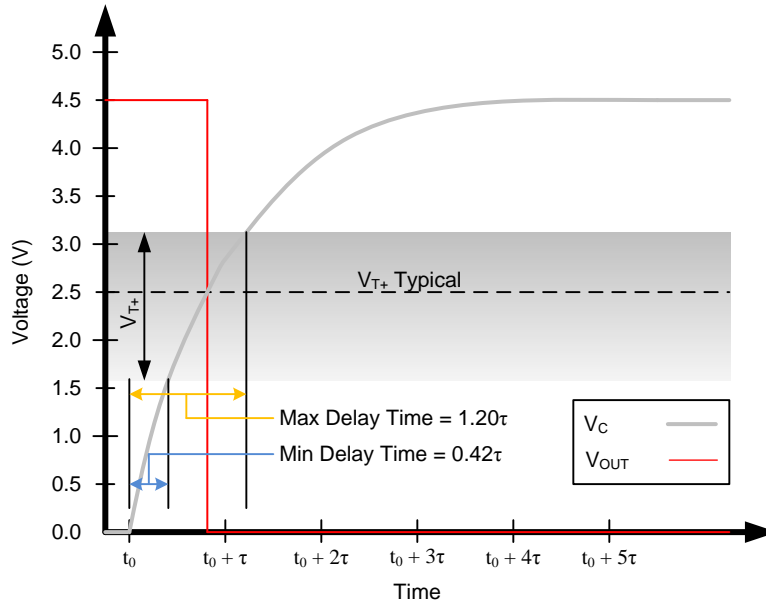

Figure 6. Ideal Capacitor Voltage and Output Voltage With Positive Switching Threshold Range Representation.

11 Power Supply Recommendations

The power supply can be any voltage between the minimum and maximum supply voltage rating located in the [Recommended Operating Conditions](#). Each  $V_{CC}$  terminal should have a good bypass capacitor to prevent power disturbance. For devices with a single supply, TI recommends a 0.1- $\mu$ F capacitor. If there are multiple  $V_{CC}$  terminals, then TI recommends a 0.01- $\mu$ F or 0.022- $\mu$ F capacitor for each power terminal. Multiple bypass capacitors can be paralleled to reject different frequencies of noise. Frequencies of 0.1  $\mu$ F and 1  $\mu$ F are commonly used in parallel. The bypass capacitor should be installed as close as possible to the power terminal for best results.

## 12 Layout

### 12.1 Layout Guidelines

When using multiple bit logic devices, inputs should never float. In many cases, functions or parts of functions of digital logic devices are unused, for example, when only two inputs of a triple-input AND gate are used or only three of the four buffer gates are used. Such input pins should not be left unconnected because the undefined voltages at the outside connections result in undefined operational states. All unused inputs of digital logic devices must be connected to a high or low bias to prevent them from floating. The logic level that should be applied to any particular unused input depends on the function of the device. Generally they will be tied to GND or  $V_{CC}$  whichever makes more sense or is more convenient. Floating outputs is generally acceptable, unless the part is a transceiver.

### 12.2 Layout Example

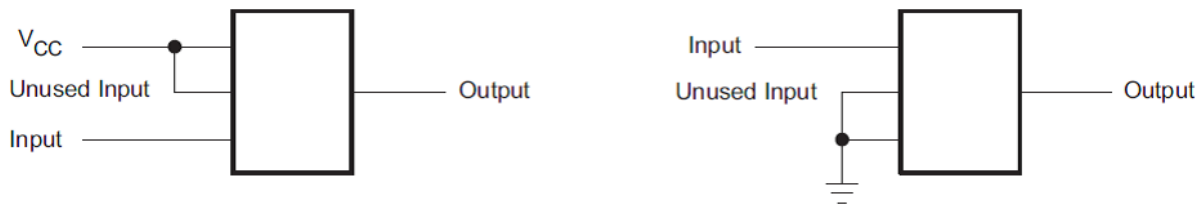

**Figure 7. Layout Recommendation**

## 13 Device and Documentation Support

### 13.1 Documentation Support

#### 13.1.1 Related Documentation

For related documentation, please see the following:

*Implications of Slow or Floating CMOS Inputs*, [SCBA004](#)

### 13.2 Related Links

The table below lists quick access links. Categories include technical documents, support and community resources, tools and software, and quick access to sample or buy.

**Table 2. Related Links**

PARTS	PRODUCT FOLDER	SAMPLE & BUY	TECHNICAL DOCUMENTS	TOOLS & SOFTWARE	SUPPORT & COMMUNITY
SN54HC05	<a href="#">Click here</a>	<a href="#">Click here</a>	<a href="#">Click here</a>	<a href="#">Click here</a>	<a href="#">Click here</a>
SN74HC05	<a href="#">Click here</a>	<a href="#">Click here</a>	<a href="#">Click here</a>	<a href="#">Click here</a>	<a href="#">Click here</a>

### 13.3 Community Resources

The following links connect to TI community resources. Linked contents are provided "AS IS" by the respective contributors. They do not constitute TI specifications and do not necessarily reflect TI's views; see TI's [Terms of Use](#).

**TI E2E™ Online Community** *TI's Engineer-to-Engineer (E2E) Community*. Created to foster collaboration among engineers. At [e2e.ti.com](http://e2e.ti.com), you can ask questions, share knowledge, explore ideas and help solve problems with fellow engineers.

**Design Support** *TI's Design Support* Quickly find helpful E2E forums along with design support tools and contact information for technical support.

### 13.4 Trademarks

E2E is a trademark of Texas Instruments.  
All other trademarks are the property of their respective owners.

### 13.5 Electrostatic Discharge Caution



These devices have limited built-in ESD protection. The leads should be shorted together or the device placed in conductive foam during storage or handling to prevent electrostatic damage to the MOS gates.

### 13.6 Glossary

[SLYZ022](#) — *TI Glossary*.

This glossary lists and explains terms, acronyms, and definitions.

## 14 Mechanical, Packaging, and Orderable Information

The following pages include mechanical, packaging, and orderable information. This information is the most current data available for the designated devices. This data is subject to change without notice and revision of this document. For browser-based versions of this data sheet, refer to the left-hand navigation.

**PACKAGING INFORMATION**

Orderable Device	Status (1)	Package Type	Package Drawing	Pins	Package Qty	Eco Plan (2)	Lead/Ball Finish (6)	MSL Peak Temp (3)	Op Temp (°C)	Device Marking (4/5)	Samples
5962-8409101VCA	ACTIVE	CDIP	J	14	1	TBD	A42	N / A for Pkg Type	-55 to 125	5962-8409101VC A SNV54HC14J	<a href="#">Samples</a>
5962-8409101VDA	ACTIVE	CFP	W	14	1	TBD	A42	N / A for Pkg Type	-55 to 125	5962-8409101VD A SNV54HC14W	<a href="#">Samples</a>
84091012A	ACTIVE	LCCC	FK	20	1	TBD	POST-PLATE	N / A for Pkg Type	-55 to 125	84091012A SNJ54HC 14FK	<a href="#">Samples</a>
8409101CA	ACTIVE	CDIP	J	14	1	TBD	A42	N / A for Pkg Type	-55 to 125	8409101CA SNJ54HC14J	<a href="#">Samples</a>
8409101DA	ACTIVE	CFP	W	14	1	TBD	A42	N / A for Pkg Type	-55 to 125	8409101DA SNJ54HC14W	<a href="#">Samples</a>
JM38510/65702BCA	ACTIVE	CDIP	J	14	1	TBD	A42	N / A for Pkg Type	-55 to 125	JM38510/ 65702BCA	<a href="#">Samples</a>
JM38510/65702BDA	ACTIVE	CFP	W	14	1	TBD	A42	N / A for Pkg Type	-55 to 125	JM38510/ 65702BDA	<a href="#">Samples</a>
M38510/65702BCA	ACTIVE	CDIP	J	14	1	TBD	A42	N / A for Pkg Type	-55 to 125	JM38510/ 65702BCA	<a href="#">Samples</a>
M38510/65702BDA	ACTIVE	CFP	W	14	1	TBD	A42	N / A for Pkg Type	-55 to 125	JM38510/ 65702BDA	<a href="#">Samples</a>
SN54HC14J	ACTIVE	CDIP	J	14	1	TBD	A42	N / A for Pkg Type	-55 to 125	SN54HC14J	<a href="#">Samples</a>
SN74HC14D	ACTIVE	SOIC	D	14	50	Green (RoHS & no Sb/Br)	CU NIPDAU	Level-1-260C-UNLIM	-40 to 85	HC14	<a href="#">Samples</a>
SN74HC14DBR	ACTIVE	SSOP	DB	14	2000	Green (RoHS & no Sb/Br)	CU NIPDAU	Level-1-260C-UNLIM	-40 to 85	HC14	<a href="#">Samples</a>
SN74HC14DBRG4	ACTIVE	SSOP	DB	14	2000	Green (RoHS & no Sb/Br)	CU NIPDAU	Level-1-260C-UNLIM	-40 to 85	HC14	<a href="#">Samples</a>
SN74HC14DE4	ACTIVE	SOIC	D	14	50	Green (RoHS & no Sb/Br)	CU NIPDAU	Level-1-260C-UNLIM	-40 to 85	HC14	<a href="#">Samples</a>
SN74HC14DG4	ACTIVE	SOIC	D	14	50	Green (RoHS & no Sb/Br)	CU NIPDAU	Level-1-260C-UNLIM	-40 to 85	HC14	<a href="#">Samples</a>
SN74HC14DR	ACTIVE	SOIC	D	14	2500	Green (RoHS & no Sb/Br)	CU NIPDAU   CU SN	Level-1-260C-UNLIM	-40 to 85	HC14	<a href="#">Samples</a>

Orderable Device	Status (1)	Package Type	Package Drawing	Pins	Package Qty	Eco Plan (2)	Lead/Ball Finish (6)	MSL Peak Temp (3)	Op Temp (°C)	Device Marking (4/5)	Samples
SN74HC14DRE4	ACTIVE	SOIC	D	14	2500	Green (RoHS & no Sb/Br)	CU NIPDAU	Level-1-260C-UNLIM	-40 to 85	HC14	<a href="#">Samples</a>
SN74HC14DRG3	ACTIVE	SOIC	D	14	2500	Green (RoHS & no Sb/Br)	CU SN	Level-1-260C-UNLIM	-40 to 85	HC14	<a href="#">Samples</a>
SN74HC14DRG4	ACTIVE	SOIC	D	14	2500	Green (RoHS & no Sb/Br)	CU NIPDAU	Level-1-260C-UNLIM	-40 to 85	HC14	<a href="#">Samples</a>
SN74HC14DT	ACTIVE	SOIC	D	14	250	Green (RoHS & no Sb/Br)	CU NIPDAU	Level-1-260C-UNLIM	-40 to 85	HC14	<a href="#">Samples</a>
SN74HC14DTG4	ACTIVE	SOIC	D	14	250	Green (RoHS & no Sb/Br)	CU NIPDAU	Level-1-260C-UNLIM	-40 to 85	HC14	<a href="#">Samples</a>
SN74HC14N	ACTIVE	PDIP	N	14	25	Pb-Free (RoHS)	CU NIPDAU   CU SN	N / A for Pkg Type	-40 to 85	SN74HC14N	<a href="#">Samples</a>
SN74HC14N3	OBSOLETE	PDIP	N	14		TBD	Call TI	Call TI	-40 to 85		
SN74HC14NE4	ACTIVE	PDIP	N	14	25	Pb-Free (RoHS)	CU NIPDAU	N / A for Pkg Type	-40 to 85	SN74HC14N	<a href="#">Samples</a>
SN74HC14NSLE	OBSOLETE	SO	NS	14		TBD	Call TI	Call TI	-40 to 85		
SN74HC14NSR	ACTIVE	SO	NS	14	2000	Green (RoHS & no Sb/Br)	CU NIPDAU	Level-1-260C-UNLIM	-40 to 85	HC14	<a href="#">Samples</a>
SN74HC14NSRE4	ACTIVE	SO	NS	14	2000	Green (RoHS & no Sb/Br)	CU NIPDAU	Level-1-260C-UNLIM	-40 to 85	HC14	<a href="#">Samples</a>
SN74HC14PW	ACTIVE	TSSOP	PW	14	90	Green (RoHS & no Sb/Br)	CU NIPDAU	Level-1-260C-UNLIM	-40 to 85	HC14	<a href="#">Samples</a>
SN74HC14PWE4	ACTIVE	TSSOP	PW	14	90	Green (RoHS & no Sb/Br)	CU NIPDAU	Level-1-260C-UNLIM	-40 to 85	HC14	<a href="#">Samples</a>
SN74HC14PWG4	ACTIVE	TSSOP	PW	14	90	Green (RoHS & no Sb/Br)	CU NIPDAU	Level-1-260C-UNLIM	-40 to 85	HC14	<a href="#">Samples</a>
SN74HC14PWLE	OBSOLETE	TSSOP	PW	14		TBD	Call TI	Call TI	-40 to 85		
SN74HC14PWR	ACTIVE	TSSOP	PW	14	2000	Green (RoHS & no Sb/Br)	CU NIPDAU   CU SN	Level-1-260C-UNLIM	-40 to 85	HC14	<a href="#">Samples</a>
SN74HC14PWRE4	ACTIVE	TSSOP	PW	14	2000	Green (RoHS & no Sb/Br)	CU NIPDAU	Level-1-260C-UNLIM	-40 to 85	HC14	<a href="#">Samples</a>
SN74HC14PWRG4	ACTIVE	TSSOP	PW	14	2000	Green (RoHS & no Sb/Br)	CU NIPDAU	Level-1-260C-UNLIM	-40 to 85	HC14	<a href="#">Samples</a>
SN74HC14PWT	ACTIVE	TSSOP	PW	14	250	Green (RoHS & no Sb/Br)	CU NIPDAU	Level-1-260C-UNLIM	-40 to 85	HC14	<a href="#">Samples</a>

Orderable Device	Status (1)	Package Type	Package Drawing	Pins	Package Qty	Eco Plan (2)	Lead/Ball Finish (6)	MSL Peak Temp (3)	Op Temp (°C)	Device Marking (4/5)	Samples
SN74HC14PWTG4	ACTIVE	TSSOP	PW	14	250	Green (RoHS & no Sb/Br)	CU NIPDAU	Level-1-260C-UNLIM	-40 to 85	HC14	<a href="#">Samples</a>
SNJ54HC14FK	ACTIVE	LCCC	FK	20	1	TBD	POST-PLATE	N / A for Pkg Type	-55 to 125	84091012A SNJ54HC 14FK	<a href="#">Samples</a>
SNJ54HC14J	ACTIVE	CDIP	J	14	1	TBD	A42	N / A for Pkg Type	-55 to 125	8409101CA SNJ54HC14J	<a href="#">Samples</a>
SNJ54HC14W	ACTIVE	CFP	W	14	1	TBD	A42	N / A for Pkg Type	-55 to 125	8409101DA SNJ54HC14W	<a href="#">Samples</a>

(1) The marketing status values are defined as follows:

**ACTIVE:** Product device recommended for new designs.

**LIFEBUY:** TI has announced that the device will be discontinued, and a lifetime-buy period is in effect.

**NRND:** Not recommended for new designs. Device is in production to support existing customers, but TI does not recommend using this part in a new design.

**PREVIEW:** Device has been announced but is not in production. Samples may or may not be available.

**OBsolete:** TI has discontinued the production of the device.

(2) Eco Plan - The planned eco-friendly classification: Pb-Free (RoHS), Pb-Free (RoHS Exempt), or Green (RoHS & no Sb/Br) - please check <http://www.ti.com/productcontent> for the latest availability information and additional product content details.

**TBD:** The Pb-Free/Green conversion plan has not been defined.

**Pb-Free (RoHS):** TI's terms "Lead-Free" or "Pb-Free" mean semiconductor products that are compatible with the current RoHS requirements for all 6 substances, including the requirement that lead not exceed 0.1% by weight in homogeneous materials. Where designed to be soldered at high temperatures, TI Pb-Free products are suitable for use in specified lead-free processes.

**Pb-Free (RoHS Exempt):** This component has a RoHS exemption for either 1) lead-based flip-chip solder bumps used between the die and package, or 2) lead-based die adhesive used between the die and leadframe. The component is otherwise considered Pb-Free (RoHS compatible) as defined above.

**Green (RoHS & no Sb/Br):** TI defines "Green" to mean Pb-Free (RoHS compatible), and free of Bromine (Br) and Antimony (Sb) based flame retardants (Br or Sb do not exceed 0.1% by weight in homogeneous material)

(3) MSL, Peak Temp. - The Moisture Sensitivity Level rating according to the JEDEC industry standard classifications, and peak solder temperature.

(4) There may be additional marking, which relates to the logo, the lot trace code information, or the environmental category on the device.

(5) Multiple Device Markings will be inside parentheses. Only one Device Marking contained in parentheses and separated by a "~" will appear on a device. If a line is indented then it is a continuation of the previous line and the two combined represent the entire Device Marking for that device.

(6) Lead/Ball Finish - Orderable Devices may have multiple material finish options. Finish options are separated by a vertical ruled line. Lead/Ball Finish values may wrap to two lines if the finish value exceeds the maximum column width.



**Important Information and Disclaimer:** The information provided on this page represents TI's knowledge and belief as of the date that it is provided. TI bases its knowledge and belief on information provided by third parties, and makes no representation or warranty as to the accuracy of such information. Efforts are underway to better integrate information from third parties. TI has taken and continues to take reasonable steps to provide representative and accurate information but may not have conducted destructive testing or chemical analysis on incoming materials and chemicals. TI and TI suppliers consider certain information to be proprietary, and thus CAS numbers and other limited information may not be available for release.

In no event shall TI's liability arising out of such information exceed the total purchase price of the TI part(s) at issue in this document sold by TI to Customer on an annual basis.

**OTHER QUALIFIED VERSIONS OF SN54HC14, SN54HC14-SP, SN74HC14 :**

- Catalog: [SN74HC14](#), [SN54HC14](#)
  
- Automotive: [SN74HC14-Q1](#), [SN74HC14-Q1](#)
  
- Military: [SN54HC14](#)
  
- Space: [SN54HC14-SP](#)

NOTE: Qualified Version Definitions:

- Catalog - TI's standard catalog product
  
- Automotive - Q100 devices qualified for high-reliability automotive applications targeting zero defects
  
- Military - QML certified for Military and Defense Applications
  
- Space - Radiation tolerant, ceramic packaging and qualified for use in Space-based application

**TAPE AND REEL INFORMATION**

**QUADRANT ASSIGNMENTS FOR PIN 1 ORIENTATION IN TAPE**

\*All dimensions are nominal

Device	Package Type	Package Drawing	Pins	SPQ	Reel Diameter (mm)	Reel Width W1 (mm)	A0 (mm)	B0 (mm)	K0 (mm)	P1 (mm)	W (mm)	Pin1 Quadrant
SN74HC14DBR	SSOP	DB	14	2000	330.0	16.4	8.2	6.6	2.5	12.0	16.0	Q1
SN74HC14DR	SOIC	D	14	2500	330.0	16.4	6.5	9.0	2.1	8.0	16.0	Q1
SN74HC14DR	SOIC	D	14	2500	330.0	16.4	6.5	9.0	2.1	8.0	16.0	Q1
SN74HC14DR	SOIC	D	14	2500	330.0	16.8	6.5	9.5	2.3	8.0	16.0	Q1
SN74HC14DRG3	SOIC	D	14	2500	330.0	16.8	6.5	9.5	2.3	8.0	16.0	Q1
SN74HC14DRG4	SOIC	D	14	2500	330.0	16.4	6.5	9.0	2.1	8.0	16.0	Q1
SN74HC14DT	SOIC	D	14	250	330.0	16.4	6.5	9.0	2.1	8.0	16.0	Q1
SN74HC14PWR	TSSOP	PW	14	2000	330.0	12.4	6.9	5.6	1.6	8.0	12.0	Q1
SN74HC14PWT	TSSOP	PW	14	250	330.0	12.4	6.9	5.6	1.6	8.0	12.0	Q1

**TAPE AND REEL BOX DIMENSIONS**

\*All dimensions are nominal

Device	Package Type	Package Drawing	Pins	SPQ	Length (mm)	Width (mm)	Height (mm)
SN74HC14DBR	SSOP	DB	14	2000	367.0	367.0	38.0
SN74HC14DR	SOIC	D	14	2500	333.2	345.9	28.6
SN74HC14DR	SOIC	D	14	2500	367.0	367.0	38.0
SN74HC14DR	SOIC	D	14	2500	364.0	364.0	27.0
SN74HC14DRG3	SOIC	D	14	2500	364.0	364.0	27.0
SN74HC14DRG4	SOIC	D	14	2500	333.2	345.9	28.6
SN74HC14DT	SOIC	D	14	250	367.0	367.0	38.0
SN74HC14PWR	TSSOP	PW	14	2000	367.0	367.0	35.0
SN74HC14PWT	TSSOP	PW	14	250	367.0	367.0	35.0

J (R-GDIP-T\*\*)

14 LEADS SHOWN

CERAMIC DUAL IN-LINE PACKAGE



DIM \ PINS **	14	16	18	20
A	0.300 (7,62) BSC	0.300 (7,62) BSC	0.300 (7,62) BSC	0.300 (7,62) BSC
B MAX	0.785 (19,94)	.840 (21,34)	0.960 (24,38)	1.060 (26,92)
B MIN	—	—	—	—
C MAX	0.300 (7,62)	0.300 (7,62)	0.310 (7,87)	0.300 (7,62)
C MIN	0.245 (6,22)	0.245 (6,22)	0.220 (5,59)	0.245 (6,22)



4040083/F 03/03

- NOTES:
- All linear dimensions are in inches (millimeters).
  - This drawing is subject to change without notice.
  - This package is hermetically sealed with a ceramic lid using glass frit.
  - Index point is provided on cap for terminal identification only on press ceramic glass frit seal only.
  - Falls within MIL STD 1835 GDIP1-T14, GDIP1-T16, GDIP1-T18 and GDIP1-T20.

W (R-GDFP-F14)

CERAMIC DUAL FLATPACK



- NOTES:
- A. All linear dimensions are in inches (millimeters).
  - B. This drawing is subject to change without notice.
  - C. This package can be hermetically sealed with a ceramic lid using glass frit.
  - D. Index point is provided on cap for terminal identification only.
  - E. Falls within MIL STD 1835 GDFP1-F14

FK (S-CQCC-N\*\*)

LEADLESS CERAMIC CHIP CARRIER

28 TERMINAL SHOWN



NO. OF TERMINALS **	A		B	
	MIN	MAX	MIN	MAX
20	0.342 (8,69)	0.358 (9,09)	0.307 (7,80)	0.358 (9,09)
28	0.442 (11,23)	0.458 (11,63)	0.406 (10,31)	0.458 (11,63)
44	0.640 (16,26)	0.660 (16,76)	0.495 (12,58)	0.560 (14,22)
52	0.740 (18,78)	0.761 (19,32)	0.495 (12,58)	0.560 (14,22)
68	0.938 (23,83)	0.962 (24,43)	0.850 (21,6)	0.858 (21,8)
84	1.141 (28,99)	1.165 (29,59)	1.047 (26,6)	1.063 (27,0)



4040140/D 01/11

- NOTES:
- All linear dimensions are in inches (millimeters).
  - This drawing is subject to change without notice.
  - This package can be hermetically sealed with a metal lid.
  - Falls within JEDEC MS-004

N (R-PDIP-T\*\*)

PLASTIC DUAL-IN-LINE PACKAGE

16 PINS SHOWN



- NOTES:
- A. All linear dimensions are in inches (millimeters).
  - B. This drawing is subject to change without notice.
  - Falls within JEDEC MS-001, except 18 and 20 pin minimum body length (Dim A).
  - The 20 pin end lead shoulder width is a vendor option, either half or full width.





D (R-PDSO-G14)

PLASTIC SMALL OUTLINE



- NOTES:
- A. All linear dimensions are in millimeters.
  - B. This drawing is subject to change without notice.
  - C. Publication IPC-7351 is recommended for alternate designs.
  - D. Laser cutting apertures with trapezoidal walls and also rounding corners will offer better paste release. Customers should contact their board assembly site for stencil design recommendations. Refer to IPC-7525 for other stencil recommendations.
  - E. Customers should contact their board fabrication site for solder mask tolerances between and around signal pads.

PW (R-PDSO-G14)

PLASTIC SMALL OUTLINE



4040064-3/G 02/11

- NOTES:
- A. All linear dimensions are in millimeters. Dimensioning and tolerancing per ASME Y14.5M-1994.
  - B. This drawing is subject to change without notice.
  -  Body length does not include mold flash, protrusions, or gate burrs. Mold flash, protrusions, or gate burrs shall not exceed 0,15 each side.
  -  Body width does not include interlead flash. Interlead flash shall not exceed 0,25 each side.
  - E. Falls within JEDEC MO-153

PW (R-PDSO-G14)

PLASTIC SMALL OUTLINE



- NOTES:
- All linear dimensions are in millimeters.
  - This drawing is subject to change without notice.
  - Publication IPC-7351 is recommended for alternate designs.
  - Laser cutting apertures with trapezoidal walls and also rounding corners will offer better paste release. Customers should contact their board assembly site for stencil design recommendations. Refer to IPC-7525 for other stencil recommendations.
  - Customers should contact their board fabrication site for solder mask tolerances between and around signal pads.

# MECHANICAL DATA

NS (R-PDSO-G\*\*)

PLASTIC SMALL-OUTLINE PACKAGE

14-PINS SHOWN



- NOTES:
- A. All linear dimensions are in millimeters.
  - B. This drawing is subject to change without notice.
  - C. Body dimensions do not include mold flash or protrusion, not to exceed 0,15.

DB (R-PDSO-G\*\*)

PLASTIC SMALL-OUTLINE

28 PINS SHOWN



- NOTES: A. All linear dimensions are in millimeters.  
 B. This drawing is subject to change without notice.  
 C. Body dimensions do not include mold flash or protrusion not to exceed 0,15.  
 D. Falls within JEDEC MO-150

## IMPORTANT NOTICE

Texas Instruments Incorporated and its subsidiaries (TI) reserve the right to make corrections, enhancements, improvements and other changes to its semiconductor products and services per JESD46, latest issue, and to discontinue any product or service per JESD48, latest issue. Buyers should obtain the latest relevant information before placing orders and should verify that such information is current and complete. All semiconductor products (also referred to herein as "components") are sold subject to TI's terms and conditions of sale supplied at the time of order acknowledgment.

TI warrants performance of its components to the specifications applicable at the time of sale, in accordance with the warranty in TI's terms and conditions of sale of semiconductor products. Testing and other quality control techniques are used to the extent TI deems necessary to support this warranty. Except where mandated by applicable law, testing of all parameters of each component is not necessarily performed.

TI assumes no liability for applications assistance or the design of Buyers' products. Buyers are responsible for their products and applications using TI components. To minimize the risks associated with Buyers' products and applications, Buyers should provide adequate design and operating safeguards.

TI does not warrant or represent that any license, either express or implied, is granted under any patent right, copyright, mask work right, or other intellectual property right relating to any combination, machine, or process in which TI components or services are used. Information published by TI regarding third-party products or services does not constitute a license to use such products or services or a warranty or endorsement thereof. Use of such information may require a license from a third party under the patents or other intellectual property of the third party, or a license from TI under the patents or other intellectual property of TI.

Reproduction of significant portions of TI information in TI data books or data sheets is permissible only if reproduction is without alteration and is accompanied by all associated warranties, conditions, limitations, and notices. TI is not responsible or liable for such altered documentation. Information of third parties may be subject to additional restrictions.

Resale of TI components or services with statements different from or beyond the parameters stated by TI for that component or service voids all express and any implied warranties for the associated TI component or service and is an unfair and deceptive business practice. TI is not responsible or liable for any such statements.

Buyer acknowledges and agrees that it is solely responsible for compliance with all legal, regulatory and safety-related requirements concerning its products, and any use of TI components in its applications, notwithstanding any applications-related information or support that may be provided by TI. Buyer represents and agrees that it has all the necessary expertise to create and implement safeguards which anticipate dangerous consequences of failures, monitor failures and their consequences, lessen the likelihood of failures that might cause harm and take appropriate remedial actions. Buyer will fully indemnify TI and its representatives against any damages arising out of the use of any TI components in safety-critical applications.

In some cases, TI components may be promoted specifically to facilitate safety-related applications. With such components, TI's goal is to help enable customers to design and create their own end-product solutions that meet applicable functional safety standards and requirements. Nonetheless, such components are subject to these terms.

No TI components are authorized for use in FDA Class III (or similar life-critical medical equipment) unless authorized officers of the parties have executed a special agreement specifically governing such use.

Only those TI components which TI has specifically designated as military grade or "enhanced plastic" are designed and intended for use in military/aerospace applications or environments. Buyer acknowledges and agrees that any military or aerospace use of TI components which have **not** been so designated is solely at the Buyer's risk, and that Buyer is solely responsible for compliance with all legal and regulatory requirements in connection with such use.

TI has specifically designated certain components as meeting ISO/TS16949 requirements, mainly for automotive use. In any case of use of non-designated products, TI will not be responsible for any failure to meet ISO/TS16949.

### Products

Audio	<a href="http://www.ti.com/audio">www.ti.com/audio</a>
Amplifiers	<a href="http://amplifier.ti.com">amplifier.ti.com</a>
Data Converters	<a href="http://dataconverter.ti.com">dataconverter.ti.com</a>
DLP® Products	<a href="http://www.dlp.com">www.dlp.com</a>
DSP	<a href="http://dsp.ti.com">dsp.ti.com</a>
Clocks and Timers	<a href="http://www.ti.com/clocks">www.ti.com/clocks</a>
Interface	<a href="http://interface.ti.com">interface.ti.com</a>
Logic	<a href="http://logic.ti.com">logic.ti.com</a>
Power Mgmt	<a href="http://power.ti.com">power.ti.com</a>
Microcontrollers	<a href="http://microcontroller.ti.com">microcontroller.ti.com</a>
RFID	<a href="http://www.ti-rfid.com">www.ti-rfid.com</a>
OMAP Applications Processors	<a href="http://www.ti.com/omap">www.ti.com/omap</a>
Wireless Connectivity	<a href="http://www.ti.com/wirelessconnectivity">www.ti.com/wirelessconnectivity</a>

### Applications

Automotive and Transportation	<a href="http://www.ti.com/automotive">www.ti.com/automotive</a>
Communications and Telecom	<a href="http://www.ti.com/communications">www.ti.com/communications</a>
Computers and Peripherals	<a href="http://www.ti.com/computers">www.ti.com/computers</a>
Consumer Electronics	<a href="http://www.ti.com/consumer-apps">www.ti.com/consumer-apps</a>
Energy and Lighting	<a href="http://www.ti.com/energy">www.ti.com/energy</a>
Industrial	<a href="http://www.ti.com/industrial">www.ti.com/industrial</a>
Medical	<a href="http://www.ti.com/medical">www.ti.com/medical</a>
Security	<a href="http://www.ti.com/security">www.ti.com/security</a>
Space, Avionics and Defense	<a href="http://www.ti.com/space-avionics-defense">www.ti.com/space-avionics-defense</a>
Video and Imaging	<a href="http://www.ti.com/video">www.ti.com/video</a>

### TI E2E Community

[e2e.ti.com](http://e2e.ti.com)