

# Transient Voltage Suppressors for ESD Protection

Low Capacitance

## ESDXXV32D-LA Series

### Description

The ESDXXV32D-LA is designed to protect voltage sensitive components from ESD and transient voltage events. Excellent clamping capability, low leakage, and fast response time, make these parts ideal for ESD protection on designs where board space is at a premium. Because of its small size, ultra-low capacitance values, it is very suitable for signal port and board space speed transmission is very small places, such as Ethernet, mobile phones, MP3 players, digital cameras and other portable.

### Feature

- u 350 Watts Peak Pulse Power per Line (tp=8/20µs)
- u Protects One Unidirectional I/O line
- u Low clamping voltage
- u Working voltages : 3.3V, 5V, 12V
- u Low leakage current
- u IEC61000-4-2 (ESD) ±15kV (air), ±8kV (contact)
- u IEC61000-4-4 (EFT) 40A (5/50ns)
- u IEC61000-4-5 (Lightning) 12A (8/20µs)

### Applications

- u Ethernet - 10/100/1000 Base T
- u Cellular Phones
- u I<sup>2</sup>C Bus Protection
- u Parallel & Serial Port Protection
- u Personal Digital Assistant (PDA)
- u Microcontroller Input Protection
- u SDN S/T Interface
- u WAN/LAN Equipment

SOD-323

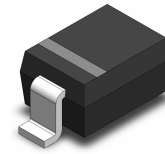

### Functional Diagram

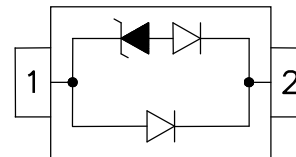

### Mechanical Characteristics

- u JEDEC SOD-323 Package
- u Molding Compound Flammability Rating : UL 94V-0
- u Weight 5.0 Milligrams (Approximate)
- u Quantity Per Reel : 3,000pcs
- u Reel Size : 7 inch
- u Lead Finish : Lead Free

### Mechanical Characteristics

Symbol	Parameter	Value	Units
P <sub>PP</sub>	Peak Pulse Power (tp=8/20µs waveform)	350	W
T <sub>L</sub>	Lead Soldering Temperature	260 (10sec)	°C
T <sub>STG</sub>	Storage Temperature Range	-55 to +150	°C
T <sub>J</sub>	Operating Temperature Range	-55 to +150	°C
	IEC61000-4-2 (ESD)	Air Discharge ±15 Contact Discharge ±8	KV
	IEC61000-4-4 (EFT)	40	A
	IEC61000-4-5 ( Lightning )	12	A

# Transient Voltage Suppressors for ESD Protection

Low Capacitance

## ESDXXV32D-LA Series

### I-V Curve Characteristics

Symbol	Parameter
$I_{PP}$	Maximum Reverse Peak Pulse Current
$V_C$	Clamping Voltage @ $I_{PP}$
$V_{RWM}$	Working Peak Reverse Voltage
$I_R$	Maximum Reverse leakage Current @ $V_{RWM}$
$I_T$	Test Current
$V_B$	Breakdown Voltage @ $I_T$
$I_F$	Forward Current
$V_F$	Forward Voltage @ $I_F$
$P_{PK}$	Peak Power Dissipation
$C$	Max Capacitance @ $V_R=0V$ & $f=1MHz$

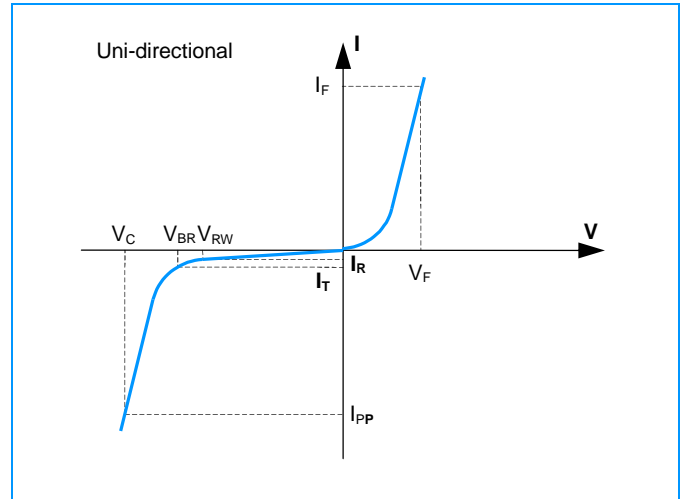

### Electrical Characteristics (@ 25°C Unless Otherwise Specified)

Part Number	Device Marking	$V_{RWM}$ (V) (Max.)	$V_B$ (V) (Min.)	$I_T$ (mA)	$V_C$ @1A (Max.)	$V_C$		$I_R$ ( $\mu A$ ) (Max.)	$C$ (pF) (Typ.)
						(Max.)	(@A)		
ESD3.3V32D-LA	S3	3.3	4.0	1	5.15	13.9	8	20	1.2
ESD05V32D-LA	S5	5.0	6.0	1	9.80	18.3	8	5	1.2
ESD12V32D-LA	SA	12.0	13.3	1	19.00	28.6	5	1	1.2

### Characteristic Curves

Fig1. 8/20 $\mu s$  Pulse Waveform

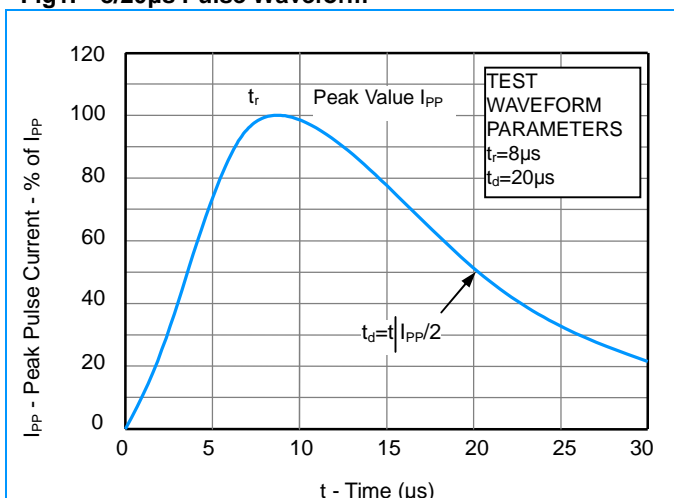
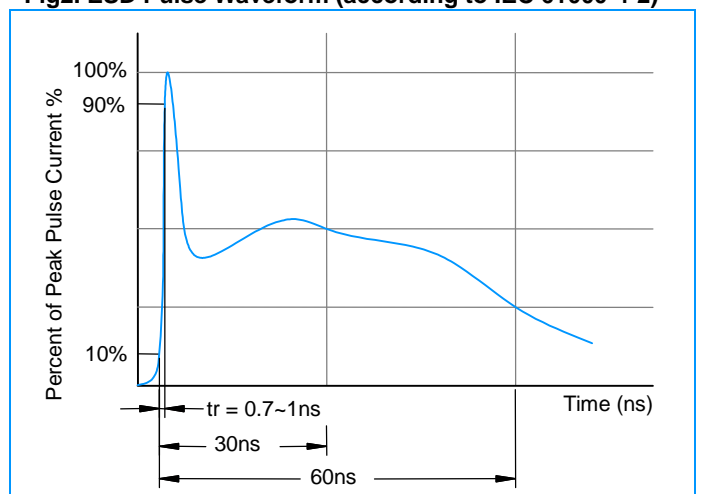

Fig2. ESD Pulse Waveform (according to IEC 61000-4-2)



# Transient Voltage Suppressors for ESD Protection

Low Capacitance

## ESDXXV32D-LA Series

### Characteristic Curves

Fig3. ESD Clamping (+8KV Contac per IEC61000-4-2)

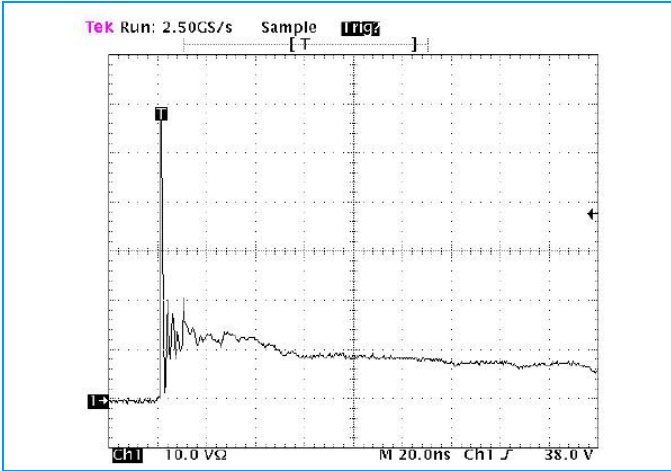
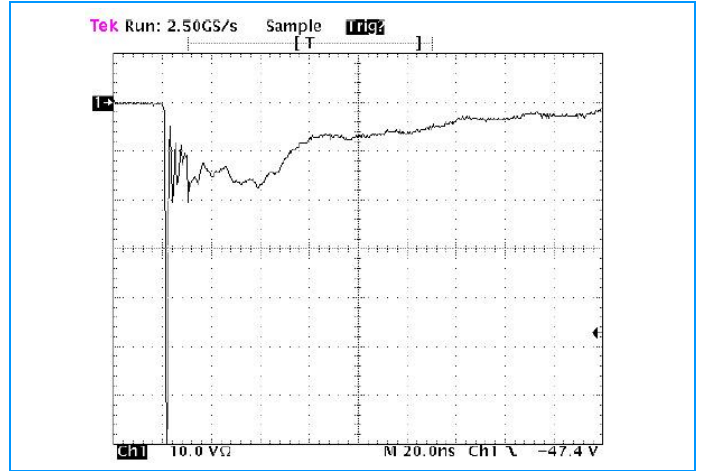
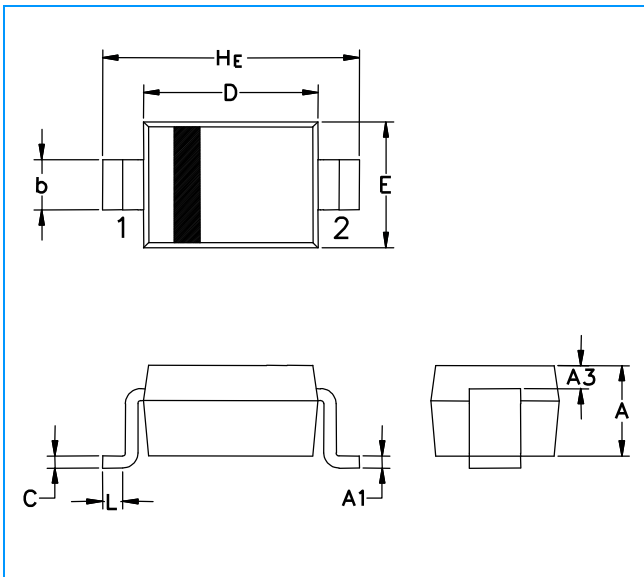

Fig4. ESD Clamping (-8KV Contac per IEC61000-4-2)



### SOD-323 Package Outline & Dimensions



Symbol	Millimeters			Inches		
	Min.	Nom.	Max.	Min.	Nom.	Max.
A	0.80	0.90	1.00	0.031	0.035	0.040
A1	0.00	0.05	0.10	0.000	0.002	0.004
A3	0.15 REF			0.006 REF		
b	0.25	0.32	0.40	0.010	0.012	0.016
C	0.089	0.12	0.177	0.003	0.005	0.007
D	1.60	1.70	1.80	0.062	0.066	0.070
E	1.15	1.25	1.35	0.045	0.049	0.053
L	0.08			0.003		
HE	2.30	2.50	2.70	0.090	0.098	0.105

### Soldering Footprint

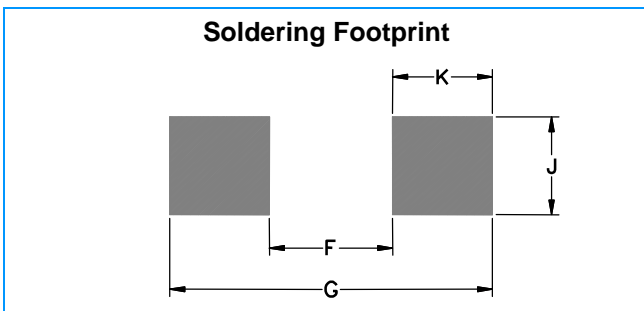

Symbol	Millimeters	Inches
F	1.60	0.063
G	2.85	0.112
J	0.83	0.033
K	0.63	0.025