

ACTF9181-1542MHz-DCC6C

Features

- ✓ Low-loss RF filter for mobile systems
- ✓ Low amplitude ripple
- ✓ No matching network required for operation at 50Ω
- ✓ Ceramic package for **Surface Mounted**
- ✓ **Technology (SMT)**
- ✓ Lead-free production and **RoHS** compliant

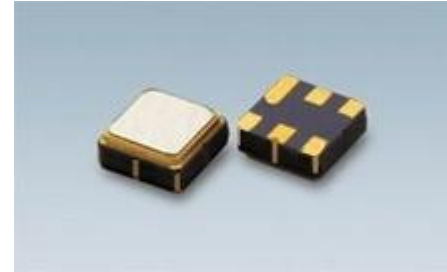

Package Dimensions

Ceramic Package: DCC6C

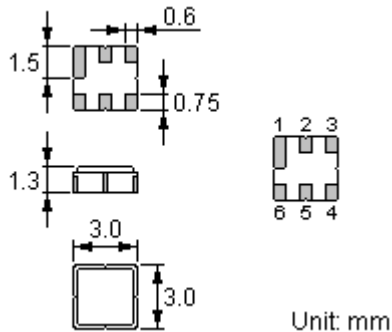

Pin Configuration

2	Input
5	Output
1, 3, 4, 6	Ground

Marking

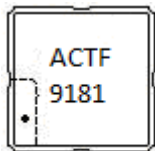

Top View, Laser Marking

"ACT":	Manufacturer's mark	"F":	SAW filter
"9181":	Part number	" . ":	Terminal 1

Maximum Ratings

Rating		Value	Unit
Input Power Level	P	10	dBm
DC Voltage	V_{DC}	0	V
Operating Temperature Range	T_A	-40 ~ +85	°C
Storage Temperature Range	T_{stg}	-40 ~ +85	°C

In line with our ongoing policy of product evolution and improvement, the above specification may subject to change without notice

ISO9001 Registered

For quotations or further information please contact us at:

3 The Business Centre, Molly Millars Lane, Wokingham, Berkshire, RG41 2EY, UK

<http://www.actcrystals.com>

Electrical Characteristics

Item		Minimum	Typical	Maximum	Unit
Center Frequency	f_c		1542		MHz
Insertion Loss	IL				
	1523.00 1561.00 MHz	--	3.0	3.5	dB
Group Delay Ripple	1523.00 1561.00 MHz		10	40	ns
Absolute Attenuation	α				
	DC 800.00 MHz	50	65		dB
	800.00 900.00 MHz	50	65		dB
	900.00 1242.00 MHz	50	55		dB
	1626.5 MHz	30	50		dB
	1842.00 1900.00 MHz	45	48		dB
	1900.00 2500.00 MHz	40	45		dB
Amplitude Ripple (p-p)	1523.00 1561.00 MHz	$\Delta\alpha$	0.8	1.3	dB
VSWR IN/OUT	1523.00 1561.00 MHz		1.8: 1	2.1: 1	dB
Input / Output Impedance (Nominal)			50		Ω

 **RoHS Compliant**

 **Electrostatic Sensitive Device**

Typical Frequency Response

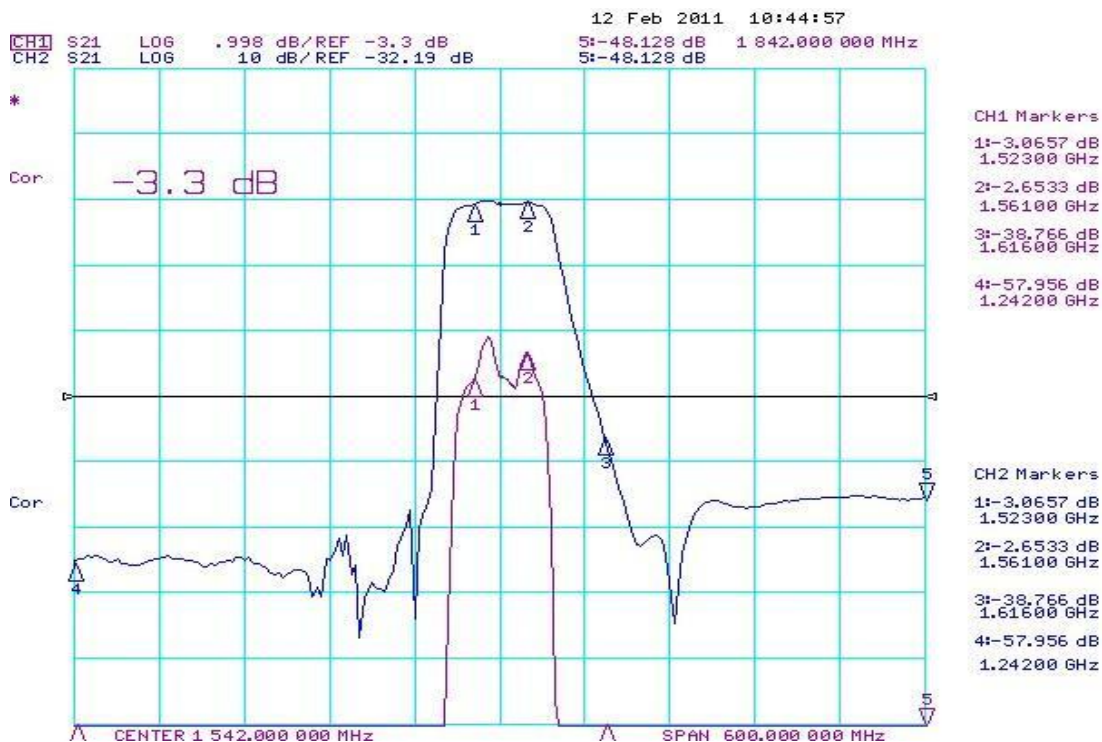

In line with our ongoing policy of product evolution and improvement, the above specification may subject to change without notice

ISO9001 Registered

For quotations or further information please contact us at:

3 The Business Centre, Molly Millars Lane, Wokingham, Berkshire, RG41 2EY, UK

<http://www.actcrystals.com>

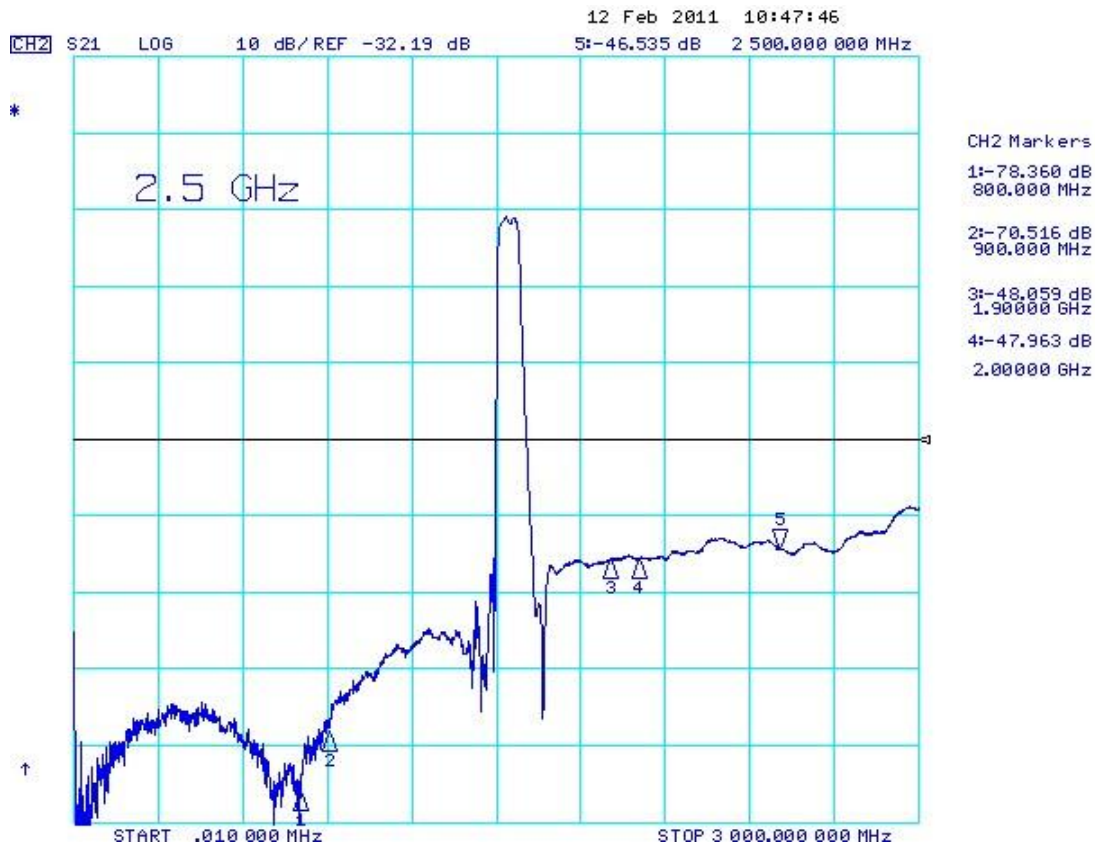
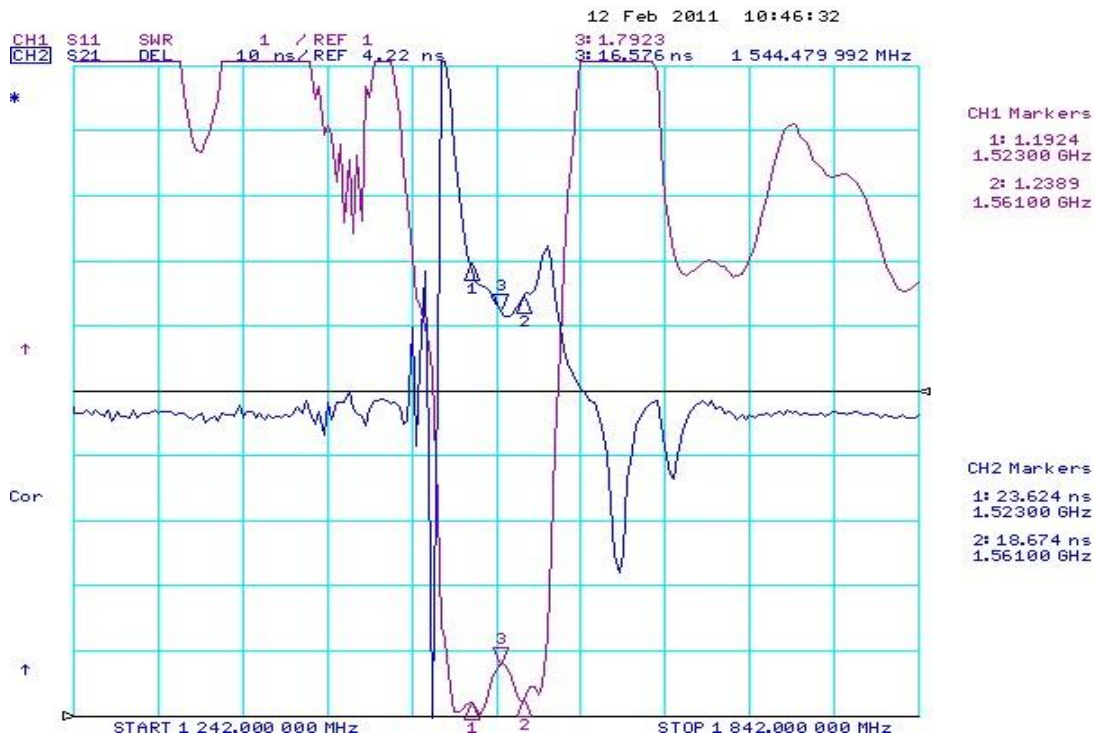

In line with our ongoing policy of product evolution and improvement, the above specification may subject to change without notice

ISO9001 Registered

For quotations or further information please contact us at:

3 The Business Centre, Molly Millars Lane, Wokingham, Berkshire, RG41 2EY, UK

<http://www.actcrystals.com>

Stability Characteristics

	Test item	Condition of test
1	Mechanical shock	(a) Drops: 3 times on concrete floor (b) Height: 1.0 m
2	Vibration resistance	(a) Frequency of vibration: 10~55Hz (c) Directions: X,Y and Z (b) Amplitude: 1.5 mm (d) Duration: 2 hours
3	Moisture resistance	(a) Condition: 40°C, 90~95% R.H. (c) Wait 4 hours before measurement (b) Duration: 96 hours
4	Climatic sequence	(a) +70°C for 16 hours (c) -25°C for 2 hours (e) Wait 4 hours before measurement (b) +55°C for 24 hours, 90~95% R.H. (d) +40°C for 24 hours, 90~95% R.H.
5	High temperature exposure	(a) Temperature: 70°C (c) Wait 4 hours before measurement (b) Duration: 250 hours
6	Thermal impact	(a) +70°C for 30 minutes ⇒ -25°C for 30 minutes repeated 3 times (b) Wait 4 hours before measurement

Requirements: The SAW filter shall remain within the electrical specifications after tests.

Remarks

- SAW devices should not be used in any type of fluid such as water, oil, organic solvent, etc.
- Be certain not to apply voltage exceeding the rated voltage of components.
- Do not operate outside the recommended operating temperature range of components.
- Sudden change of temperature shall be avoided, deterioration of the characteristics can occur.
- Be careful of soldering temperature and duration of components when soldering.
- Do not place soldering iron on the body of components.
- Be careful not to subject the terminals or leads of components to excessive force.
- SAW devices are electrostatic sensitive. Please avoid static voltage during operation and storage.
- Ultrasonic cleaning shall be avoided. Ultrasonic vibration may cause destruction of components.

Test Circuit

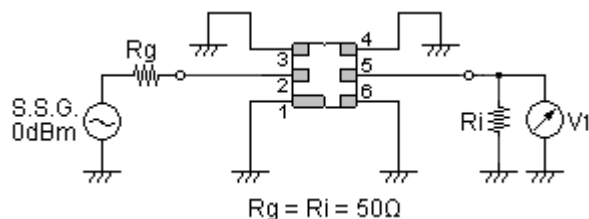

Recommended Land Pattern

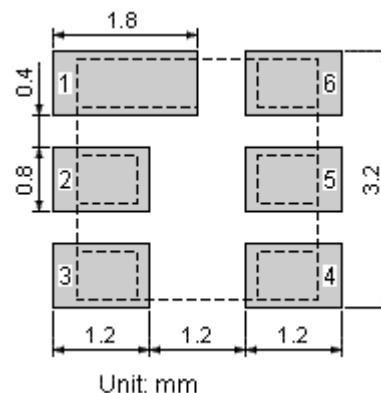

In line with our ongoing policy of product evolution and improvement, the above specification may subject to change without notice

ISO9001 Registered

For quotations or further information please contact us at:

3 The Business Centre, Molly Millars Lane, Wokingham, Berkshire, RG41 2EY, UK

<http://www.actcrystals.com>

Packing Information

Carrier Tape

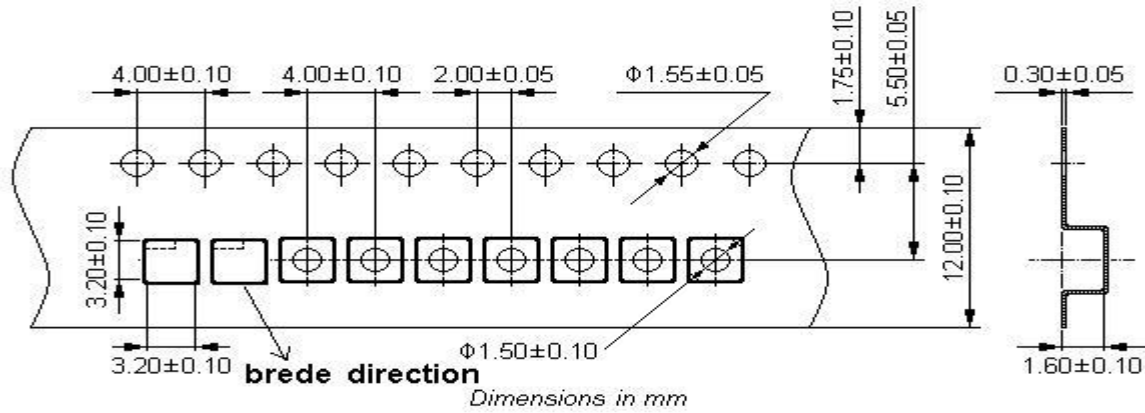

Reel Dimensions

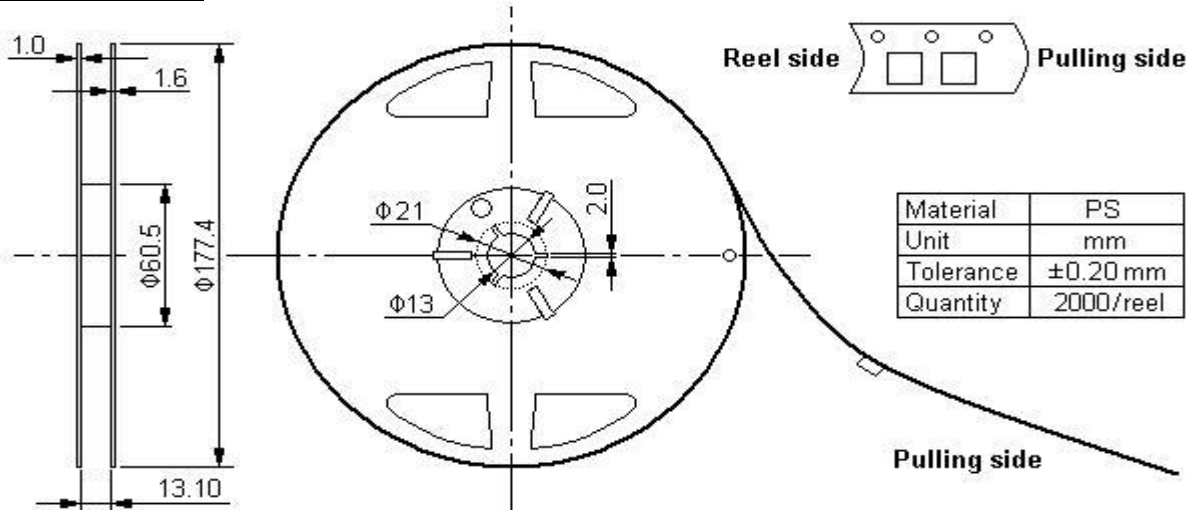

Outer Packing

Type	Quantity	Dimension	Description	Weight
Carton Box I	10000	190x190x95	anti-static plastic bag & carton box 1 reel / bag	0.85
Carton Box II	20000	190x190x190	5 bags / box (10000 pcs) 10 bags / box (20000 pcs)	1.80

Unit: mm

Unit: kg

In line with our ongoing policy of product evolution and improvement, the above specification may subject to change without notice

ISO9001 Registered

For quotations or further information please contact us at:

3 The Business Centre, Molly Millars Lane, Wokingham, Berkshire, RG41 2EY, UK

<http://www.actcrystals.com>

Recommended Soldering Profile

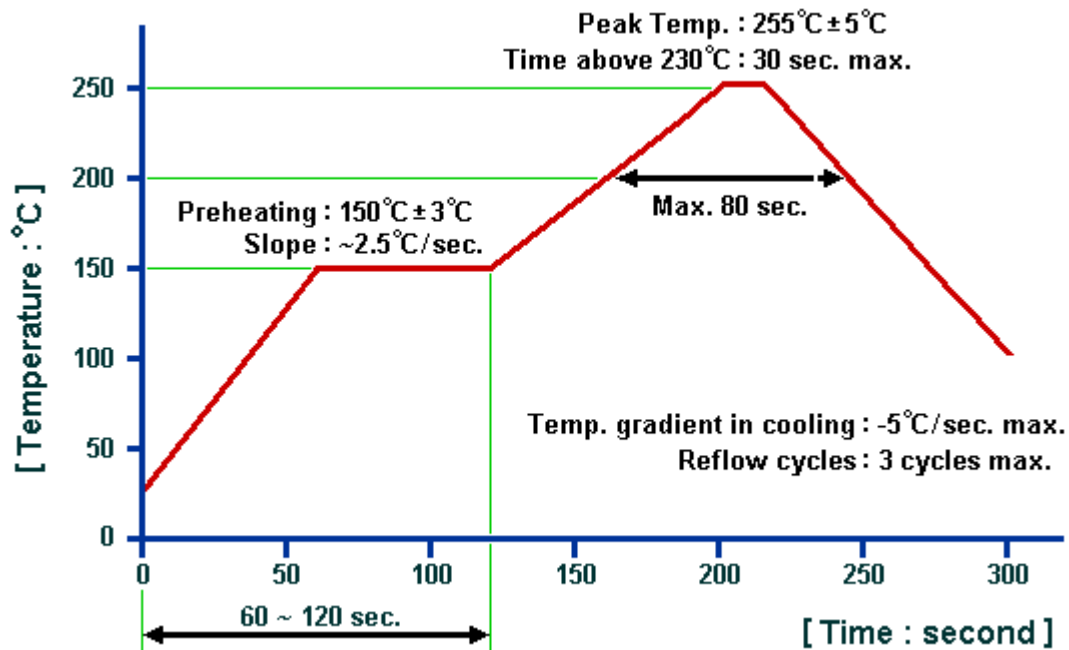

© ACT All Rights Reserved.

1. The specifications of this device are subject to change or obsolescence without notice.
2. Typically, equipment utilizing this device requires emissions testing and government approval, which is the responsibility of the equipment manufacturer.
3. Our liability is only assumed for the Surface Acoustic Wave (SAW) component(s) per se, not for applications, processes and circuits implemented within components or assemblies.

In line with our ongoing policy of product evolution and improvement, the above specification may subject to change without notice

ISO9001 Registered

For quotations or further information please contact us at:

3 The Business Centre, Molly Millars Lane, Wokingham, Berkshire, RG41 2EY, UK

<http://www.actcrystals.com>