

FEATURES

- ▶ SMD Package with Industry Standard Pinout
- ▶ Package Dimension:
15.3 x 8.0 x 7.1 mm (0.6" x 0.31" x 0.28")
- ▶ High I/O-Isolation 3000 VDC
- ▶ Operating Temp. Range -40° to +85°C
- ▶ High Accuracy of Pin Planarity
- ▶ Qualified for lead-free reflow solder process according
IPC/JEDEC J-STD-020D
- ▶ Tape & Reel Package available
- ▶ 3 Year Product Warranty



PRODUCT OVERVIEW

The MSAU300 series is a range of 1W DC/DC converters in a SMD- Package featuring high I/O-isolation of 3000VDC. The small footprint makes this product the ideal solution for many applications where a voltage has to be isolated i.e for noise reduction, ground loop elimination, in digital interfaces or where a higher I/O isolation is required.

An excellent efficiency allows an operating temperature range of -40°C to +85°C. These converters are fully qualified for the higher temperature profile used in lead-free reflow solder processes. For automated SMD production lines the product can also be supplied in tape& reel package.

Model Selection Guide

Model Number	Input Voltage (Range) VDC	Output Voltage VDC	Output Current		Input Current		Load Regulation % (max.)	Max. capacitive Load uF	Efficiency (typ.) @Max. Load %
			Max. mA	Min. mA	@Max. Load mA(typ.)	@No Load mA(typ.)			
MSAU301	5 (4.5 ~ 5.5)	5	200	4	281	30	10	33	71
MSAU303		12	84	1.5	258		7	4.7	78
MSAU304		15	67	1	258		7	4.7	78
MSAU306		±5	±100	±2	277		10	10#	72
MSAU308		±12	±42	±0.8	255		7	2.2#	78
MSAU309		±15	±34	±0.7	258		7	2.2#	79
MSAU311	12 (10.8 ~ 13.2)	5	200	4	117	12	8	33	71
MSAU313		12	84	1.5	106		5	4.7	79
MSAU314		15	67	1	104		5	4.7	80
MSAU316		±5	±100	±2	112		8	10#	74
MSAU318		±12	±42	±0.8	105		5	2.2#	80
MSAU319		±15	±34	±0.7	104		5	2.2#	81
MSAU321	24 (21.6 ~ 26.4)	5	200	4	58	7	8	33	71
MSAU323		12	84	1.5	53		5	4.7	78
MSAU324		15	67	1	53		5	4.7	79
MSAU326		±5	±100	±2	57		8	10#	72
MSAU328		±12	±42	±0.8	53		5	2.2#	79
MSAU329		±15	±34	±0.7	53		5	2.2#	80

For each output

Input Specifications

Parameter	Model	Min.	Typ.	Max.	Unit
Input Voltage Range	5V Input Models	4.5	5	5.5	VDC
	12V Input Models	10.8	12	13.2	
	24V Input Models	21.6	24	26.4	
Input Surge Voltage (1 sec. max.)	5V Input Models	-0.7	---	9	VDC
	12V Input Models	-0.7	---	18	
	24V Input Models	-0.7	---	30	
Reverse Polarity Input Current	All Models	---	---	0.3	A
Input Filter		Internal Capacitor			mW
Internal Power Dissipation		---	---	550	



Output Specifications

Parameter	Conditions	Min.	Typ.	Max.	Unit
Output Voltage Accuracy		---	±1.5	±4.0	%
Output Voltage Balance	Dual Output, Balanced Loads	---	±0.1	±1.0	%
Line Regulation	For Vin Change of 1%	---	±1.2	±1.5	%
Load Regulation	Io=20% to 100%	See Model Selection Guide			
Ripple & Noise (20MHz)		---	75	100	mV _{P-P}
Ripple & Noise (20MHz)	Over Line, Load & Temp.	---	---	150	mV _{P-P}
Ripple & Noise (20MHz)		---	---	15	mV rms
Temperature Coefficient		---	±0.01	±0.02	%/°C
Short Circuit Protection		0.5 Second Max.			

General Specifications

Parameter	Conditions	Min.	Typ.	Max.	Unit
I/O Isolation Voltage (rated)	60 Seconds	3000	---	---	VDC
I/O Isolation Resistance	500 VDC	10	---	---	GΩ
I/O Isolation Capacitance	100KHz, 1V	---	60	100	pF
Switching Frequency		50	100	150	KHz
MTBF (calculated)	MIL-HDBK-217F@25°C, Ground Benign	2,000,000	---	---	Hours
Moisture Sensitivity Level (MSL)	IPC/JEDEC J-STD-020D	Level 3			

Input Fuse

5V Input Models	12V Input Models	24V Input Models
500mA Slow-Blow Type	200mA Slow-Blow Type	100mA Slow-Blow Type

Environmental Specifications

Parameter	Conditions	Min.	Max.	Unit
Operating Temperature Range (with Derating)	Ambient	-40	+85	°C
Case Temperature		---	+90	°C
Storage Temperature Range		-50	+125	°C
Humidity (non condensing)		---	95	% rel. H
Cooling	Free-Air convection			
Lead Temperature (1.5mm from case for 10Sec.)		---	300	°C

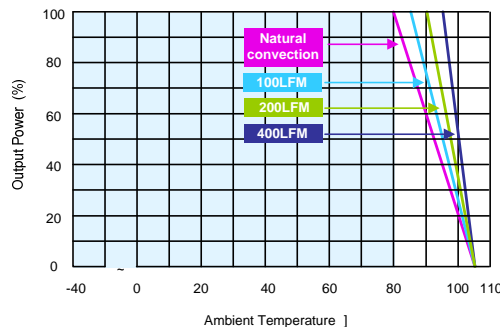
Power Derating Curve

Notes

- Specifications typical at Ta=+25°C, resistive load, nominal input voltage and rated output current unless otherwise noted.
- Ripple & Noise measurement bandwidth is 0-20MHz.
- These power converters require a minimum output loading to maintain specified regulation, operation under no-load conditions will not damage these modules; however they may not meet all specifications listed.
- All DC/DC converters should be externally fused at the front end for protection.
- Other input and output voltage may be available, please contact factory.
- Specifications subject to change without notice.

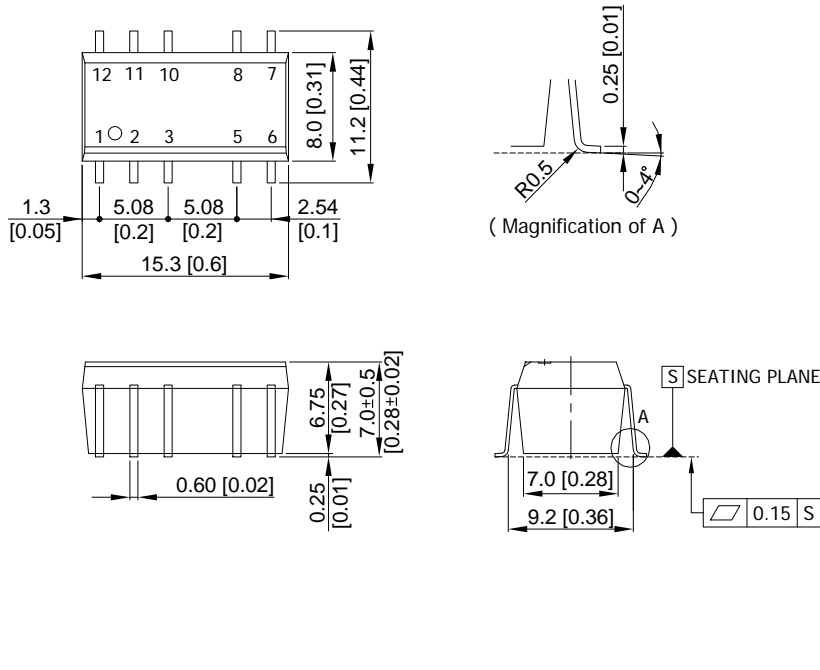
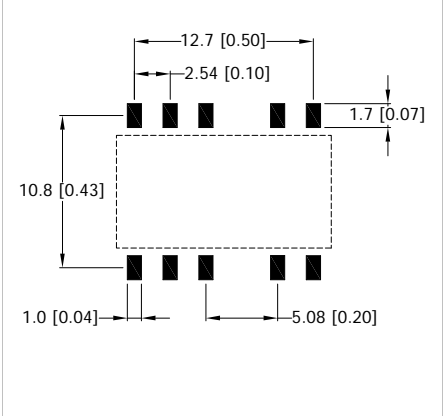

Package Specifications
Mechanical Dimensions

Connecting Pin Patterns

- ▶ All dimensions in mm (inches)
- ▶ Tolerance: X.X±0.25 (X.XX±0.01)
X.XX±0.13 (X.XXX±0.005)
- ▶ Pins ±0.05 (±0.002)

Pin Connections

Pin	Single Output	Dual Output
1	-Vin	-Vin
2	+Vin	+Vin
3	NA	NA
5	-Vout	Common
6	NA	-Vout
7	NA	NA
8	+Vout	+Vout
10	NA	NA
11	NA	NA
12	NA	NA

NA : Not Available for Electrical Connection

Physical Characteristics

Case Size	: 15.3x8.0x6.75mm (0.60x0.31x0.27 Inches)
Case Material	: Molding (flammability to UL 94V-0 rated)
Weight	: 2.2g



Test Configurations

Input Reflected-Ripple Current Test Setup

Input reflected-ripple current is measured with an inductor L_{in} (4.7uH) and C_{in} (220uF, ESR < 1.0Ω at 100 KHz) to simulate source impedance. Capacitor C_{in} , offsets possible battery impedance. Current ripple is measured at the input terminals of the module, measurement bandwidth is 0-500 KHz.

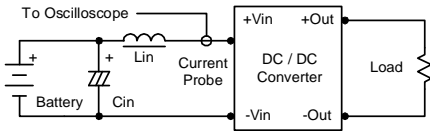

Peak-to-Peak Output Noise Measurement Test

Use a C_{out} 0.33uF ceramic capacitor. Scope measurement should be made by using a BNC socket, measurement bandwidth is 0-20 MHz. Position the load between 50 mm and 75 mm from the DC/DC Converter.

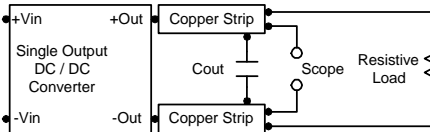

Design & Feature Considerations

Maximum Capacitive Load

The MSAU300 series has limitation of maximum connected capacitance at the output. The power module may be operated in current limiting mode during start-up, affecting the ramp-up and the startup time. The maximum capacitance can be found in the data sheet.

Input Source Impedance

The power module should be connected to a low ac-impedance input source. Highly inductive source impedances can affect the stability of the power module. In applications where power is supplied over long lines and output loading is high, it may be necessary to use a capacitor at the input to ensure startup. Capacitor mounted close to the power module helps ensure stability of the unit, it is recommended to use a good quality low Equivalent Series Resistance (ESR < 1.0Ω at 100 KHz) capacitor of a 2.2uF for the 5V input devices, a 1.0uF for the 12V input devices and a 0.47uF for the 24V devices..

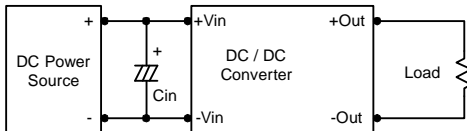

Output Ripple Reduction

A good quality low ESR capacitor placed as close as practicable across the load will give the best ripple and noise performance. To reduce output ripple, it is recommended to use 1.0uF capacitors at the output.

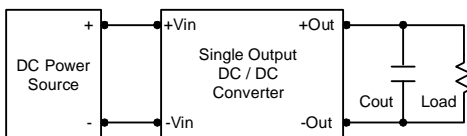

Thermal Considerations

Many conditions affect the thermal performance of the power module, such as orientation, airflow over the module and board spacing. To avoid exceeding the maximum temperature rating of the components inside the power module, the case temperature must be kept below 90°C. The derating curves are determined from measurements obtained in a test setup.

