

MITSUBISHI IGBT MODULES

CM300HA-24H

HIGH POWER SWITCHING USE
INSULATED TYPE

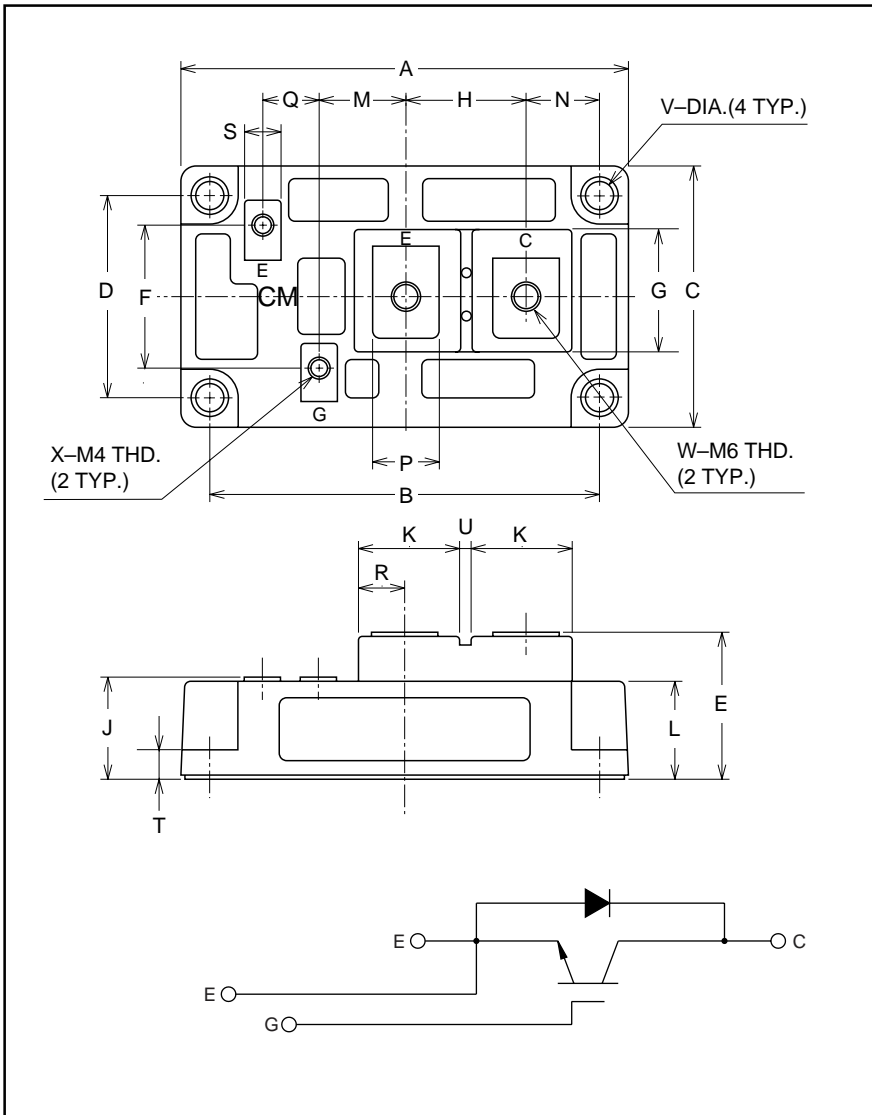

Outline Drawing and Circuit Diagram

Dimensions	Inches	Millimeters
A	4.21	107.0
B	3.661±0.01	93.0±0.25
C	2.44	62.0
D	1.89±0.01	48.0±0.25
E	1.42 Max.	36.0 Max.
F	1.34	34.0
G	1.18	30.0
H	1.14	29.0
J	0.98 Max.	25.0 Max.
K	0.94	24.0
L	0.93	23.5

Dimensions	Inches	Millimeters
M	0.83	21.0
N	0.69	17.5
P	0.63	16.0
Q	0.51	13.0
R	0.43	11.0
S	0.35	9.0
T	0.28	7.0
U	0.12	3.0
V	0.26 Dia.	Dia. 6.5
W	M6 Metric	M6
X	M4 Metric	M4



Description:

Mitsubishi IGBT Modules are designed for use in switching applications. Each module consists of one IGBT in a single configuration with a reverse-connected super-fast recovery free-wheel diode. All components and interconnects are isolated from the heat sinking baseplate, offering simplified system assembly and thermal management.

Features:

- Low Drive Power
- Low $V_{CE(sat)}$
- Discrete Super-Fast Recovery Free-Wheel Diode
- High Frequency Operation
- Isolated Baseplate for Easy Heat Sinking

Applications:

- AC Motor Control
- Motion/Servo Control
- UPS
- Welding Power Supplies

Ordering Information:

Example: Select the complete part module number you desire from the table below -i.e. CM300HA-24H is a 1200V (V_{CES}), 300 Ampere Single IGBT Module.

Type	Current Rating Amperes	V_{CES} Volts (x 50)
CM	300	24

CM300HA-24H

HIGH POWER SWITCHING USE
INSULATED TYPE**Absolute Maximum Ratings, $T_j = 25\text{ }^\circ\text{C}$ unless otherwise specified**

Ratings	Symbol	CM600HU-12H	Units
Junction Temperature	T_j	-40 to 150	$^\circ\text{C}$
Storage Temperature	T_{stg}	-40 to 125	$^\circ\text{C}$
Collector-Emitter Voltage (G-E SHORT)	V_{CES}	1200	Volts
Gate-Emitter Voltage (C-E SHORT)	V_{GES}	± 20	Volts
Collector Current ($T_c = 25^\circ\text{C}$)	I_c	300	Amperes
Peak Collector Current ($T_j \leq 150^\circ\text{C}$)	I_{CM}	600*	Amperes
Emitter Current** ($T_c = 25^\circ\text{C}$)	I_E	300	Amperes
Peak Emitter Current**	I_{EM}	600*	Amperes
Maximum Collector Dissipation ($T_c = 25^\circ\text{C}$)	P_c	2100	Watts
Mounting Torque, M6 Main Terminal	–	1.96–2.94	N · m
Mounting Torque, M6 Mounting	–	1.96–2.94	N · m
Mounting Torque, M4 Terminal	–	0.98–1.47	N · m
Weight	–	400	Grams
Isolation Voltage (Main Terminal to Baseplate, AC 1 min.)	V_{iso}	2500	Vrms

* Pulse width and repetition rate should be such that the device junction temperature (T_j) does not exceed $T_{j(\text{max})}$ rating.

**Represents characteristics of the anti-parallel, emitter-to-collector free-wheel diode (FWDi).

Static Electrical Characteristics, $T_j = 25\text{ }^\circ\text{C}$ unless otherwise specified

Characteristics	Symbol	Test Conditions	Min.	Typ.	Max.	Units
Collector-Cutoff Current	I_{CES}	$V_{\text{CE}} = V_{\text{CES}}, V_{\text{GE}} = 0\text{V}$	–	–	1.0	mA
Gate Leakage Current	I_{GES}	$V_{\text{GE}} = V_{\text{GES}}, V_{\text{CE}} = 0\text{V}$	–	–	0.5	μA
Gate-Emitter Threshold Voltage	$V_{\text{GE(th)}}$	$I_c = 30\text{mA}, V_{\text{CE}} = 10\text{V}$	4.5	6.0	7.5	Volts
Collector-Emitter Saturation Voltage	$V_{\text{CE(sat)}}$	$I_c = 300\text{A}, V_{\text{GE}} = 15\text{V}$	–	2.5	3.4**	Volts
		$I_c = 300\text{A}, V_{\text{GE}} = 15\text{V}, T_j = 150^\circ\text{C}$	–	2.25	–	Volts
Total Gate Charge	Q_G	$V_{\text{CC}} = 600\text{V}, I_c = 300\text{A}, V_{\text{GE}} = 15\text{V}$	–	1500	–	nC
Emitter-Collector Voltage	V_{EC}	$I_E = 300\text{A}, V_{\text{GE}} = 0\text{V}$	–	–	3.4	Volts

** Pulse width and repetition rate should be such that device junction temperature rise is negligible.

Dynamic Electrical Characteristics, $T_j = 25\text{ }^\circ\text{C}$ unless otherwise specified

Characteristics	Symbol	Test Conditions	Min.	Typ.	Max.	Units
Input Capacitance	C_{ies}		–	–	60	nF
Output Capacitance	C_{oes}	$V_{\text{GE}} = 0\text{V}, V_{\text{CE}} = 10\text{V}$	–	–	21	nF
Reverse Transfer Capacitance	C_{res}		–	–	12	nF
Resistive	Turn-on Delay Time	$V_{\text{CC}} = 600\text{V}, I_c = 300\text{A}$	–	–	250	ns
	Rise Time					
Switching	Turn-off Delay Time	$V_{\text{GE1}} = V_{\text{GE2}} = 15\text{V}, R_G = 1.0\Omega$	–	–	350	ns
	Fall Time					
Diode Reverse Recovery Time	t_{rr}	$I_E = 300\text{A}, di_E/dt = -600\text{A}/\mu\text{s}$	–	–	250	ns
Diode Reverse Recovery Charge	Q_{rr}	$I_E = 300\text{A}, di_E/dt = -600\text{A}/\mu\text{s}$	–	2.23	–	μC

Thermal and Mechanical Characteristics, $T_j = 25\text{ }^\circ\text{C}$ unless otherwise specified

Characteristics	Symbol	Test Conditions	Min.	Typ.	Max.	Units
Thermal Resistance, Junction to Case	$R_{\text{th(j-c)}}$	Per IGBT	–	–	0.06	$^\circ\text{C}/\text{W}$
Thermal Resistance, Junction to Case	$R_{\text{th(j-c)}}$	Per FWDi	–	–	0.12	$^\circ\text{C}/\text{W}$
Contact Thermal Resistance	$R_{\text{th(c-f)}}$	Per Module, Thermal Grease Applied	–	–	0.04	$^\circ\text{C}/\text{W}$

CM300HA-24H

HIGH POWER SWITCHING USE
INSULATED TYPE

OUTPUT CHARACTERISTICS (TYPICAL)

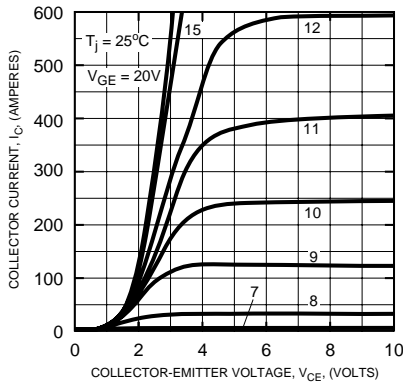

TRANSFER CHARACTERISTICS (TYPICAL)

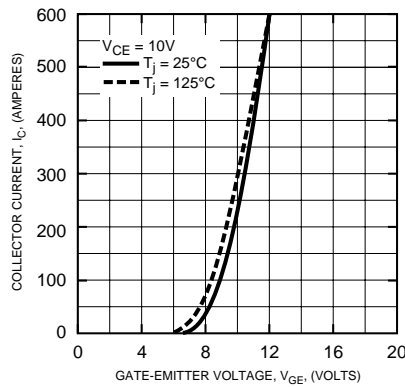

COLLECTOR-EMITTER SATURATION VOLTAGE CHARACTERISTICS (TYPICAL)

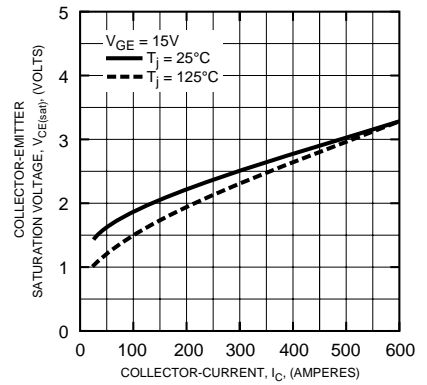

COLLECTOR-EMITTER SATURATION VOLTAGE CHARACTERISTICS (TYPICAL)

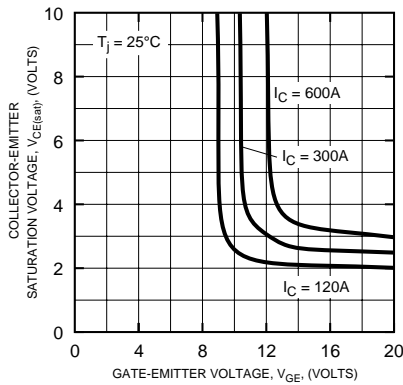

FREE-WHEEL DIODE FORWARD CHARACTERISTICS (TYPICAL)

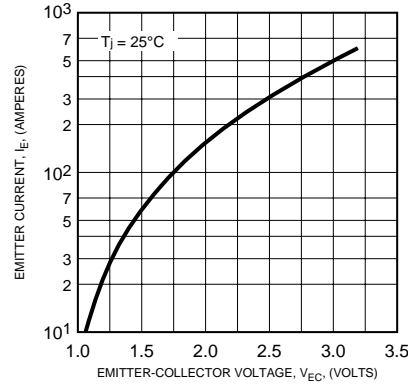

CAPACITANCE VS. V_{CE} (TYPICAL)

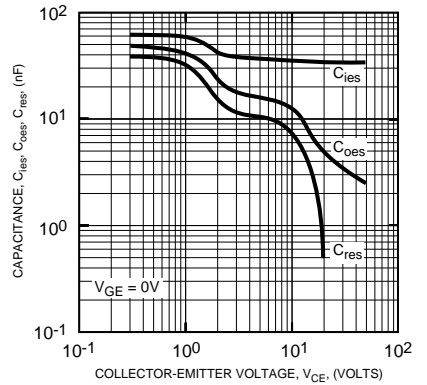

HALF-BRIDGE SWITCHING CHARACTERISTICS (TYPICAL)

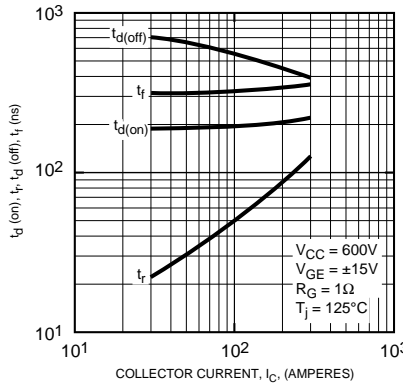

REVERSE RECOVERY CHARACTERISTICS (TYPICAL)

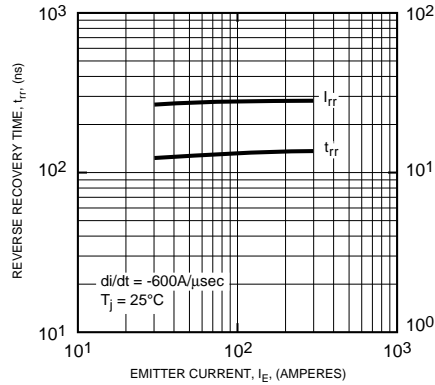

GATE CHARGE, V_{GE}

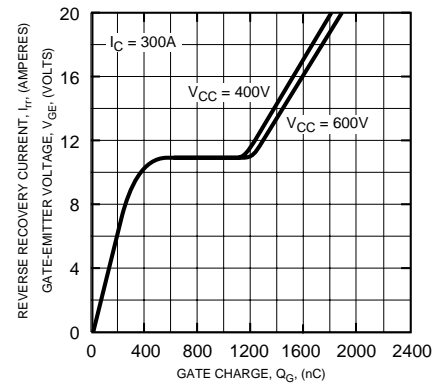

CM300HA-24H

HIGH POWER SWITCHING USE
INSULATED TYPE

