



Mounted Profile

Mounted on White Roof



## Spartan

MA600.W.A.ABC.001

## Specification

<b>Part No.</b>	<b>MA600.W.A.ABC.001</b>
<b>Product Name</b>	<b>Spartan</b> MA600.W Spartan Screw Mount 3in1 Combination Antenna - White Version - GPS/GLONASS: 1575~1602MHz - Cellular: GSM/CDMA/HSPA/UMTS 2.4GHz / 5GHz
<b>Feature</b>	High performance outdoor antenna Custom cables and connectors available White Housing RoHS Compliant

# 1. Introduction

The Spartan MA600.W antenna is a white, heavy-duty, fully IP67 waterproof external M2M antenna for use in telematics, transportation and remote monitoring applications.

The Spartan is unique in the market because it combines a 3in1 GPS/GLONASS, Cellular (2G and 3G) and Wi-Fi, heavy-duty antenna with high efficiency in a compact format. The antenna screws down permanently onto a roof or metal panel and can be pole or wall-mounted with a metal bracket. The white color is ideal for mounting

on white truck roofs or cabs or industrial equipment.

For industries such as commercial vehicle telematics, remote monitoring, smart meter systems and construction equipment, the Spartan provides a robust, rugged antenna that is durable, even in extreme environments.

All while still maintaining 20dB isolation between antennas. It uses high-shielded PTFE dielectric ultra low-loss cables that maintain low attenuation at all frequency bands, with an average 0.3dB per meter

(0.1dB per foot), compared to 0.7dB for RG58 and 1.2dB for RG174.

Because of this, the Spartan maximizes chances of passing PTCRB and network approvals first time. The Spartan also has excellent GPS/GLONASS reception without need to attach to an external ground-plane due to coupling to its unique own metal base.

Note: for ground-isolation antennas use the MA.605 version with Isolation Gaskets. Also available in Black.

# 2. Specification

## GPS-GLONASS

<b>Centre Frequency</b>	1575.42MHz / 1602MHz
<b>Bandwidth</b>	10MHz
<b>Radiation Efficiency</b>	50 (without cable)
<b>Passive Gain @ Zenith</b>	4.0 typ (with $\psi = 140\text{mm}$ ground)
<b>VSWR</b>	2
<b>Impedance</b>	50 $\Omega$
<b>DC Power Input Range</b>	3 ~ 5V

DC input	3.3V		4.0V		5.5V	
<b>MHz</b>	<b>1575.42</b>	<b>1602</b>	<b>1575.42</b>	<b>1602</b>	<b>1575.42</b>	<b>1602</b>
<b>VSWR</b>	2	2	2	2	2	2
<b>LNA Gain</b>	29.2	29	31	31	32.3	32
<b>Noise Figure</b>	3.1	3.1	3.2	3.2	3.4	3.4
<b>Power Consumption</b>	7.5	7.5	9.4	9.4	15	15
<b>Band Attenuation</b>	1520MHz: -20dB		1520MHz: -20dB		1520MHz: -20dB	
	1642MHz: -20dB		1642MHz: -20dB		1642MHz: -20dB	

<b>Cable</b>	3M RG-174 standard, fully customizable
<b>Connector</b>	SMA(M) standard, fully customizable

## 2. Specification

### Cellular

<b>Frequency (GHz)</b>	824 ~ 896	880 ~ 960	1710 ~ 1880	1850 ~ 1990	1710 ~ 2170
<b>Peak Gain (dBi)</b>	2.1	-0.2	2.9	3.0	5.1
<b>Average (dBi)</b>	-4.7	-7.5	-2.7	-3.1	-3.1
<b>Efficiency</b>	35%	20%	51%	49%	49%
<b>Impedance</b>	50Ω				
<b>Polarization</b>	Linear				
<b>Radiation Pattern</b>	Omni				
<b>Cable</b>	3M CFD200 standard, fully customizable				
<b>Connector</b>	SMA(M) standard, fully customizable				

### WIFI

<b>Frequency (GHz)</b>	2.4 ~ 2.5	4.7 ~ 5.0	5.0 ~ 5.4	5.4 ~ 5.9
<b>Peak Gain (dBi)</b>	2.1	2.9	3.8	2.8
<b>Average Gain (dBi)</b>	-2.3	-3.6	-3.3	-3.8
<b>Efficiency</b>	60%	44%	46%	42%
<b>VSWR</b>	<=1.6:1			
<b>Impedance</b>	50Ω			
<b>Polarization</b>	Linear			
<b>Radiation Pattern</b>	Omni			
<b>Cable</b>	3M CFD200 standard, fully customizable			
<b>Connector</b>	SMA(M) standard, standard, fully customizable			

### Mechanical

<b>Dimensions</b>	Profile 39.5mm x Diameter 145.6mm
<b>Casing</b>	UV resistant PVC
<b>Base and thread</b>	Nickel Plated Zinc
<b>Thread diameter</b>	30mm
<b>Waterproof</b>	IP67

### Environmental

<b>Temperature Range</b>	-40°C to 85°C
<b>Humidity</b>	Non-condensing 65°C 95% RH

\* All measurements are done in free space with standard cables.

### 3. GPS/GLONASS Antenna Characteristics

#### 3.1 Block Diagram

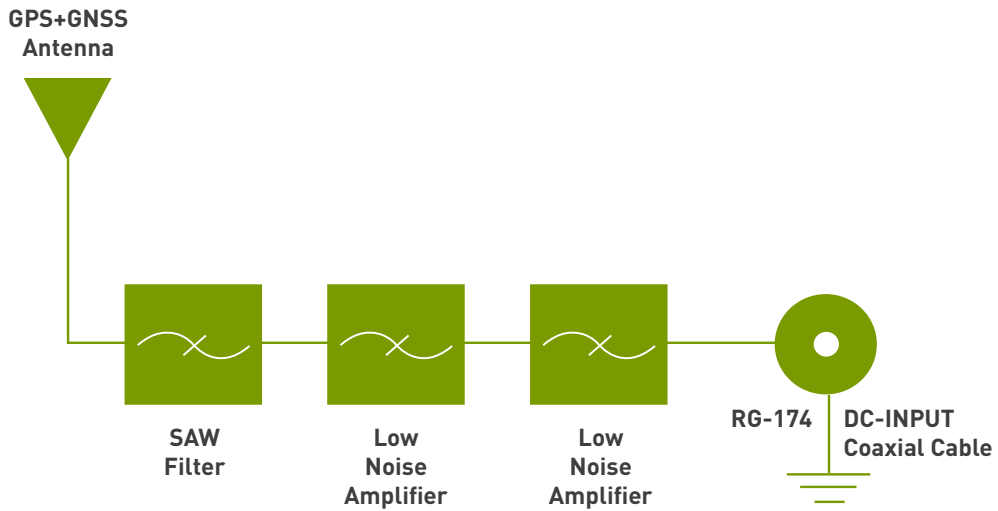

#### 3.2 Return Loss

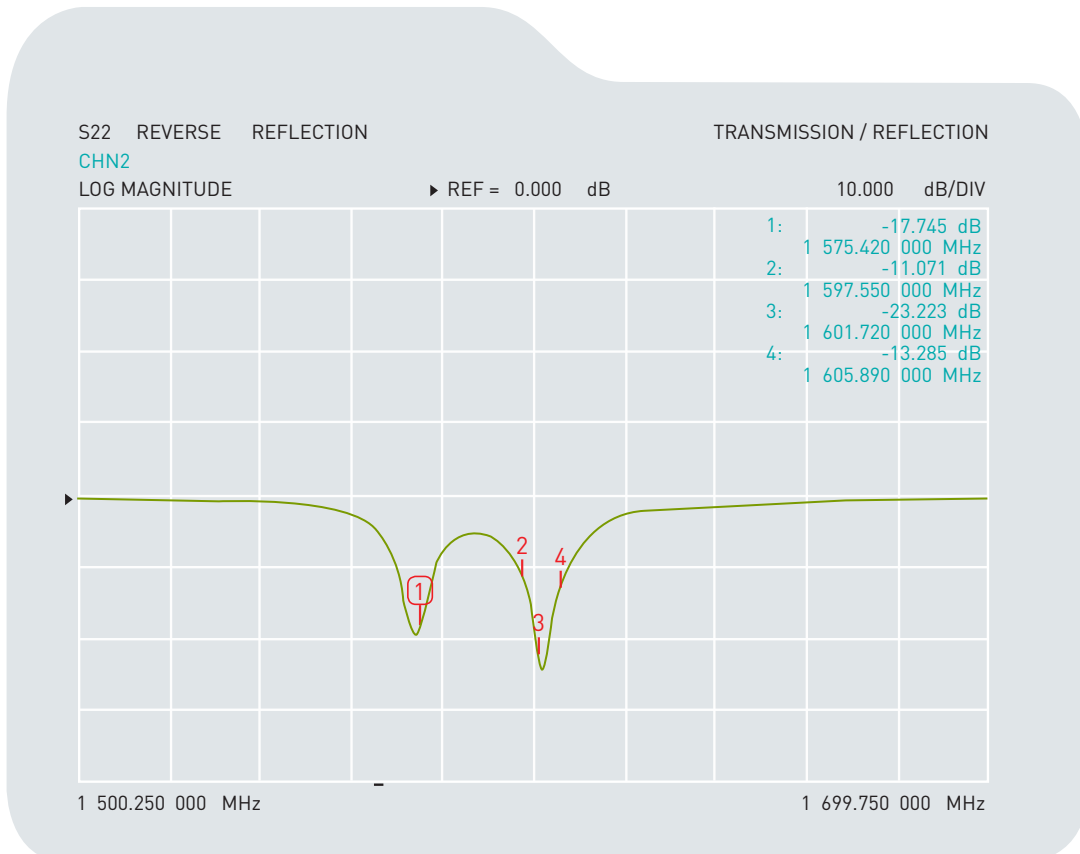

### 3.3 GPS/GLONASS Antenna Radiation Pattern

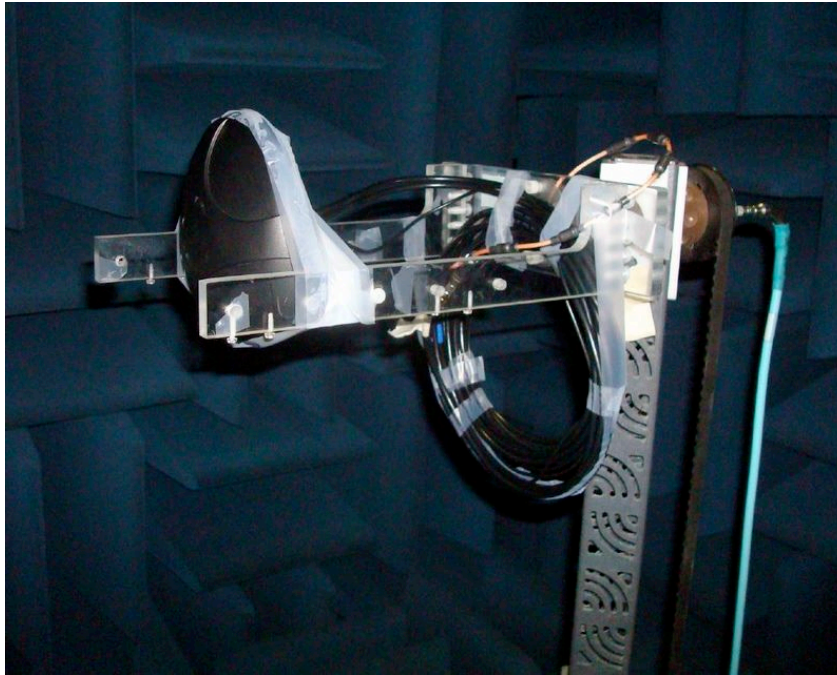

MA.600 tested in CTIA approved 3D chamber



XYZ co-ordinate for reference

### 3.4 Radiation Pattern

XZ-plane Free Space @1575.42MHz

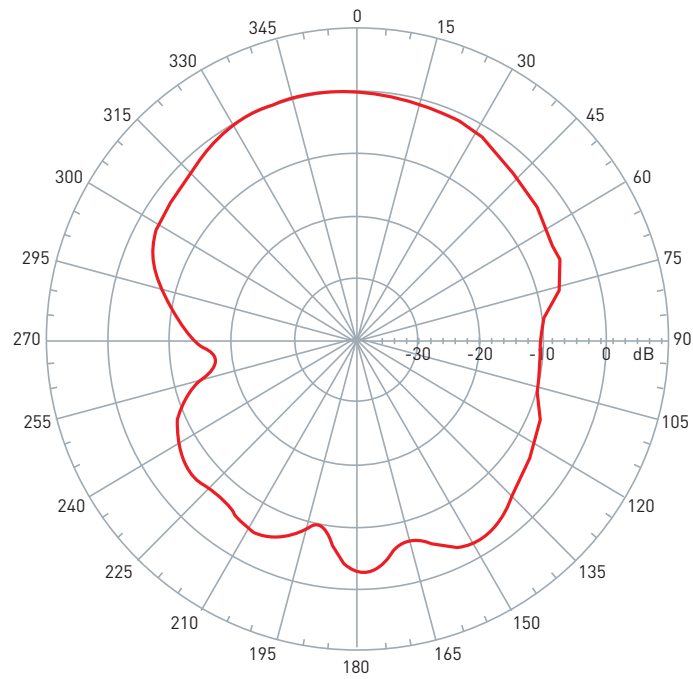

YZ-plane Free Space @1575.42MHz

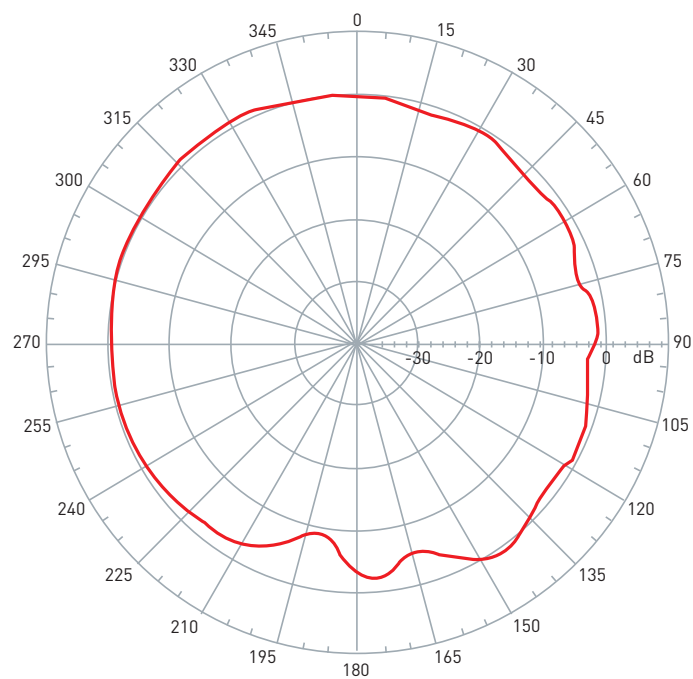

### 3.4 Radiation Pattern

XZ-plane Free Space @1602MHz

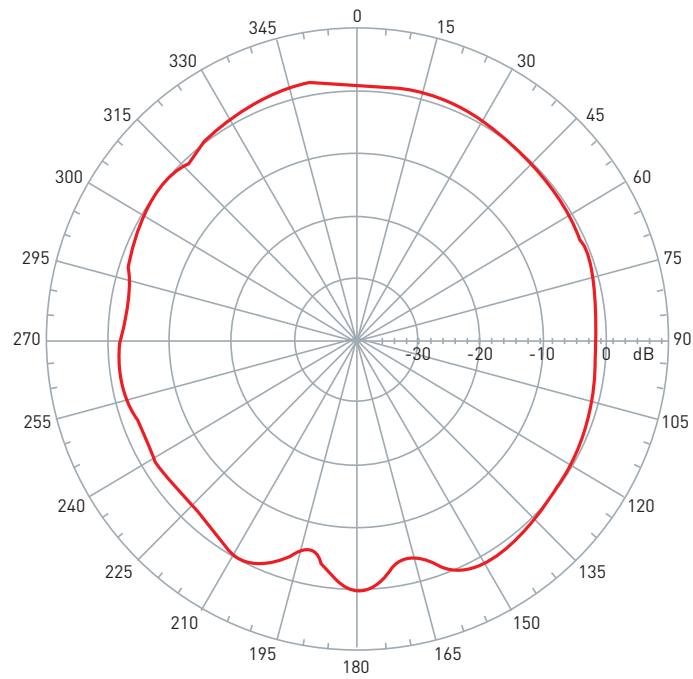

YZ-plane Free Space @1602MHz

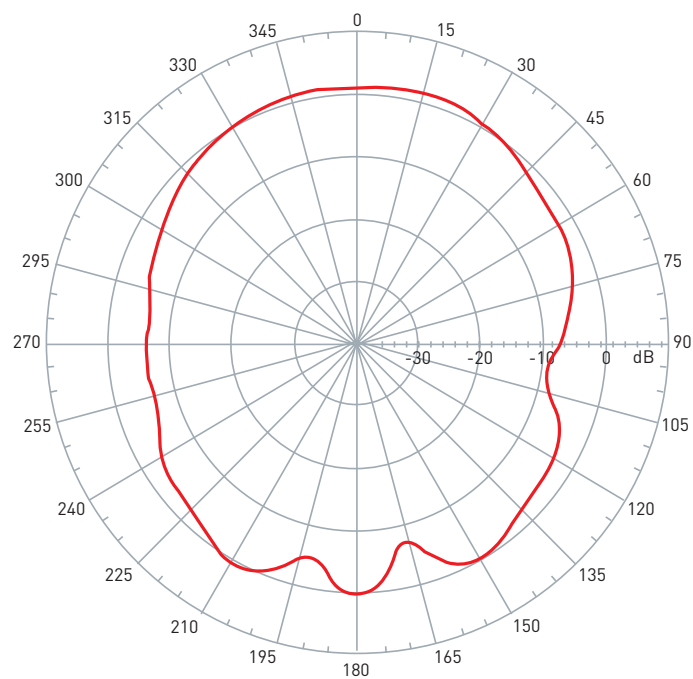

### 3.5 GPS/GLONASS LNA

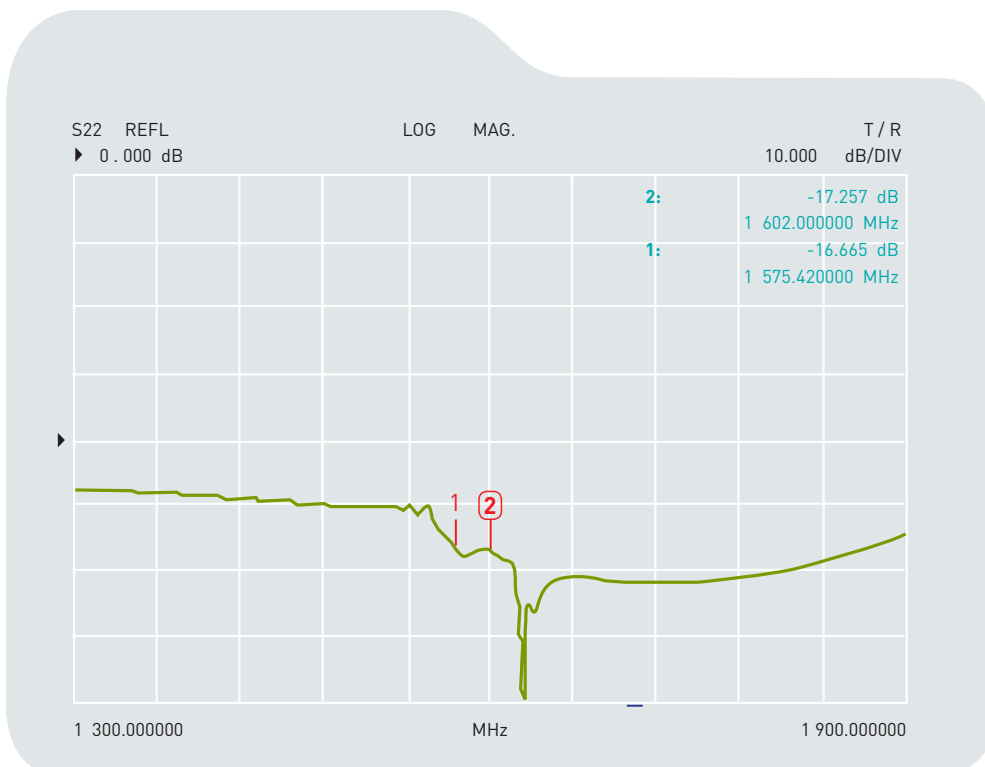
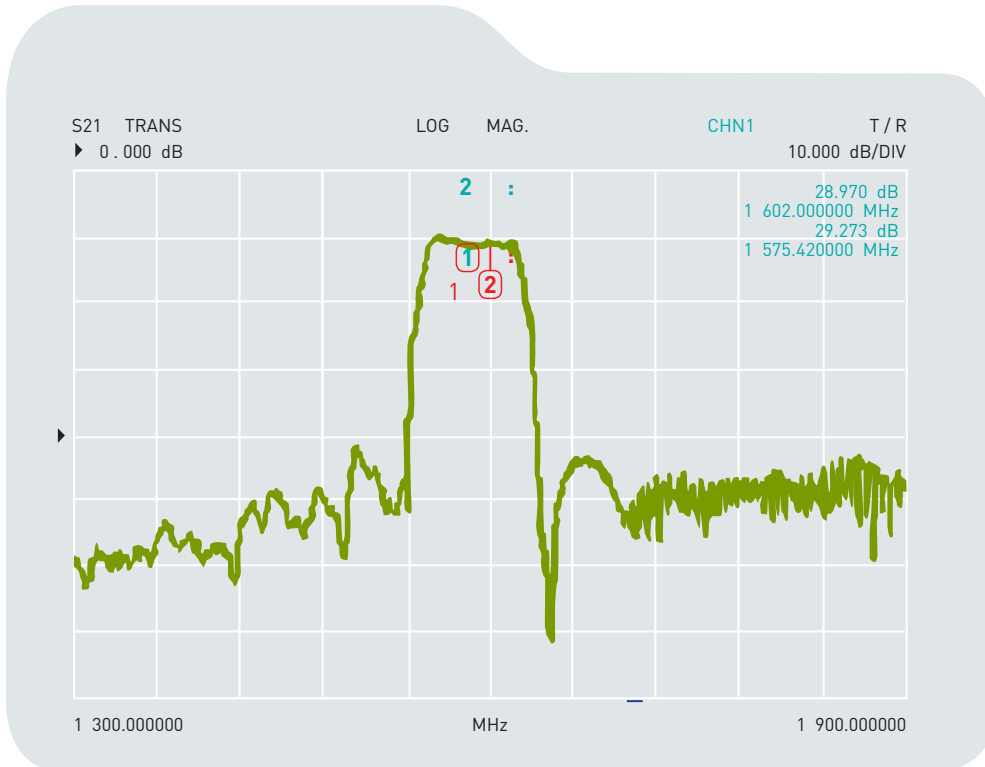



## 4. Cellular Antenna Characteristics

### 4.1 Return Loss

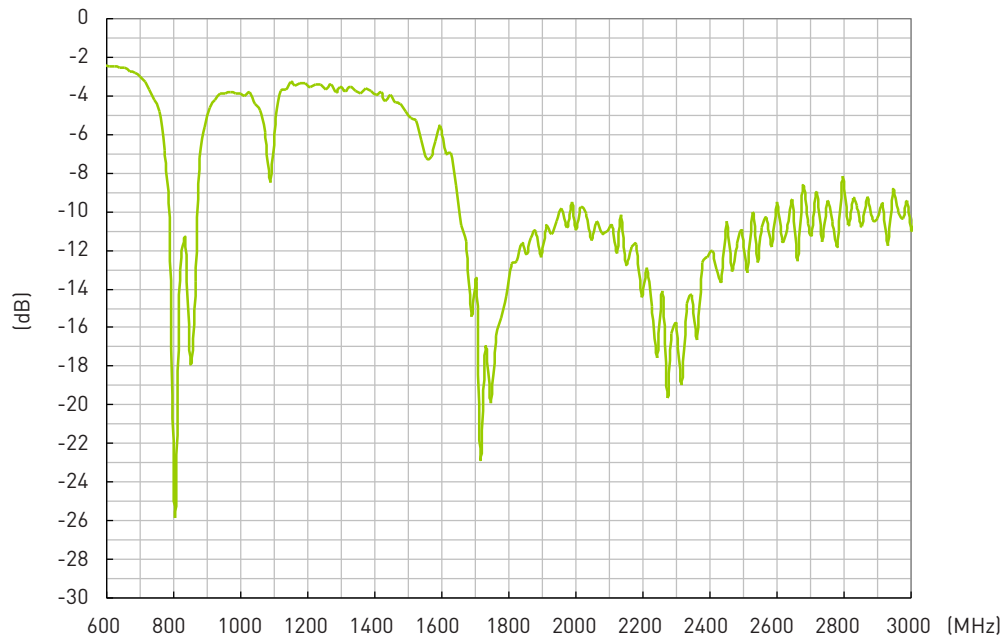

### 4.2 VSWR

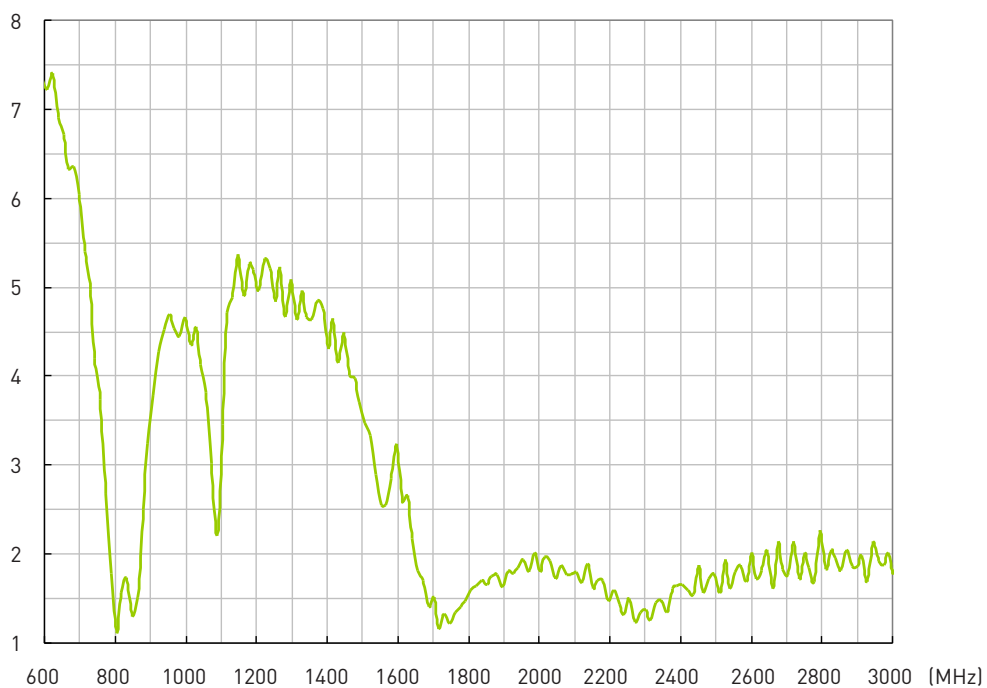

## 4. Cellular Antenna Characteristics

### 4.3 Cellular Antenna Efficiency

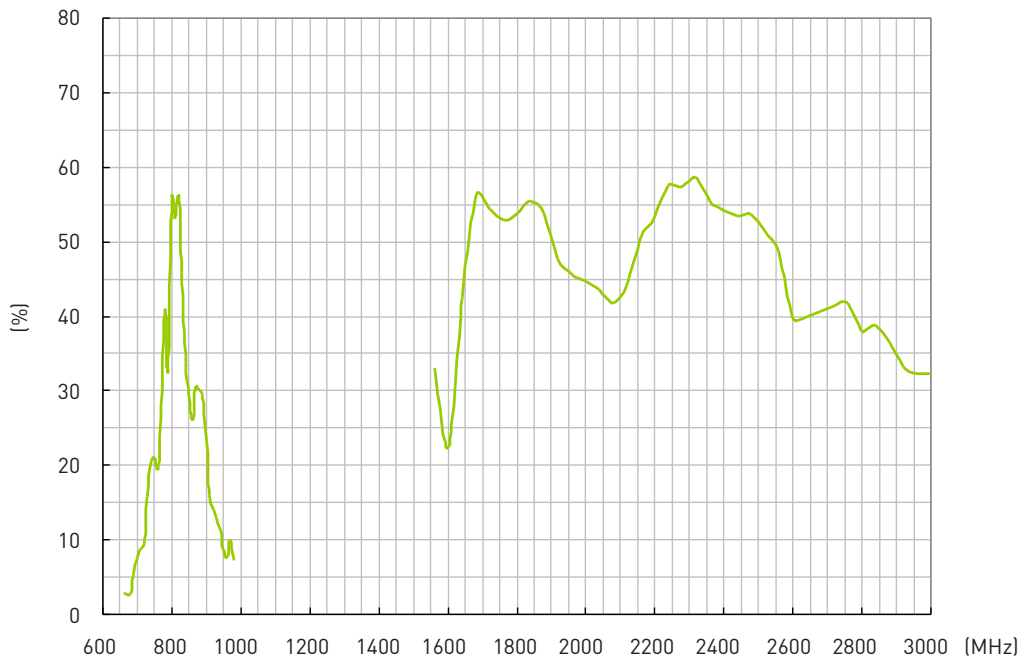

### 4.4 Cellular Antenna Peak Gain

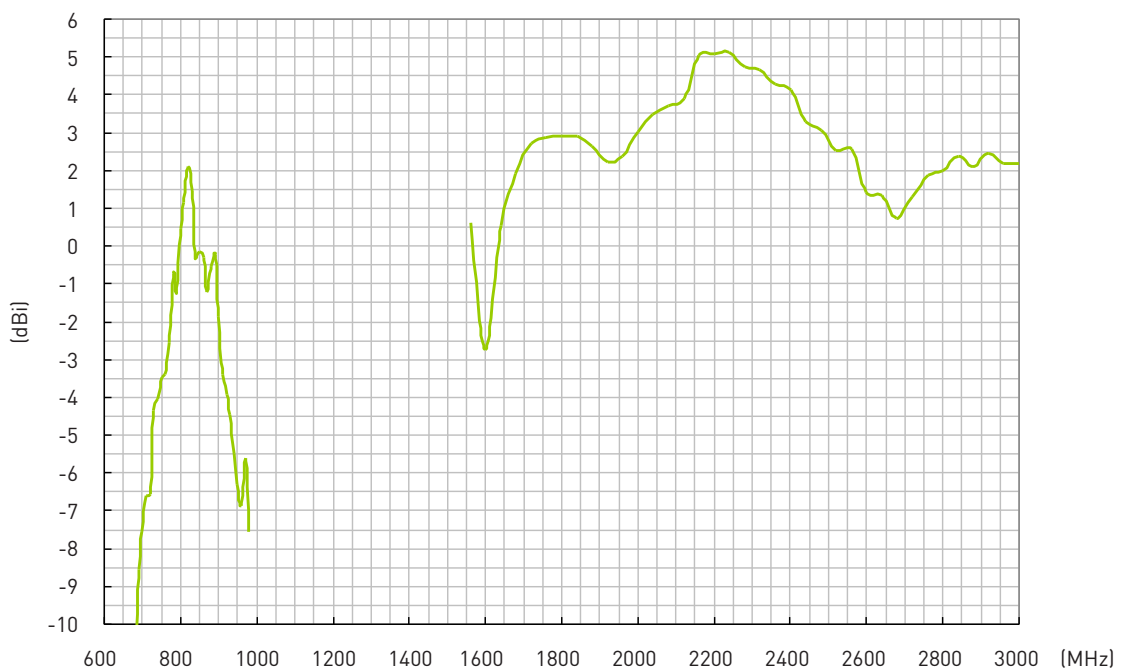

## 4.5 Cellular Antenna 3D Average Gain

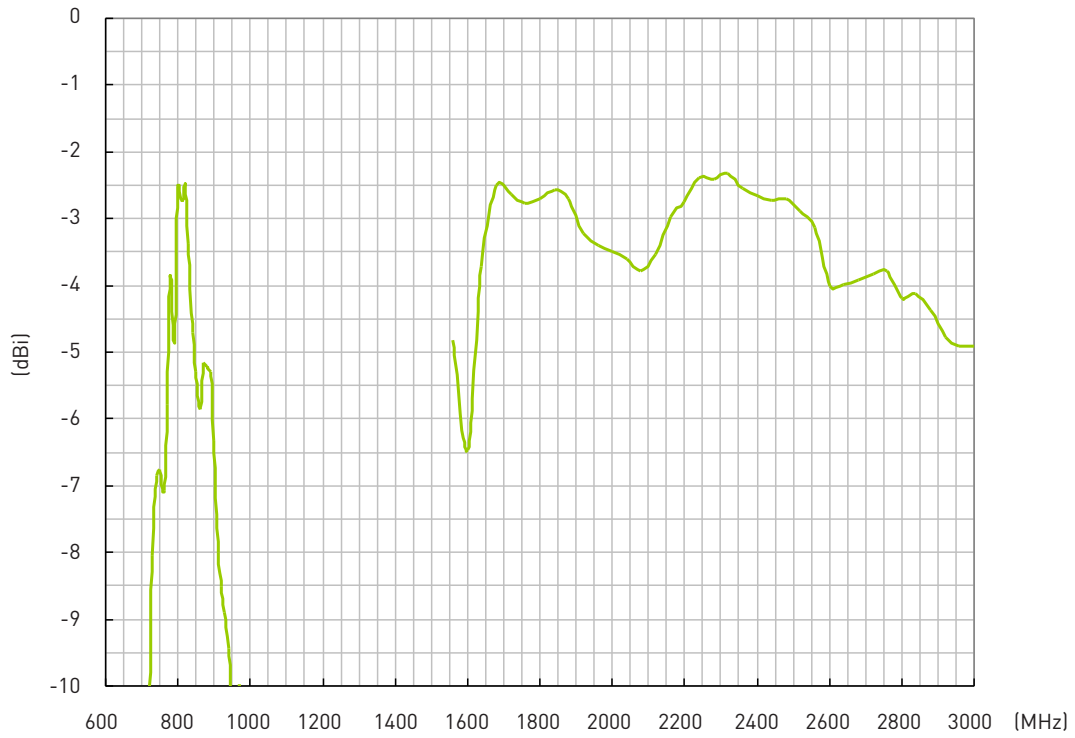

## 5. Cellular Antenna Radiation Pattern

### 5.1 XY-Plane

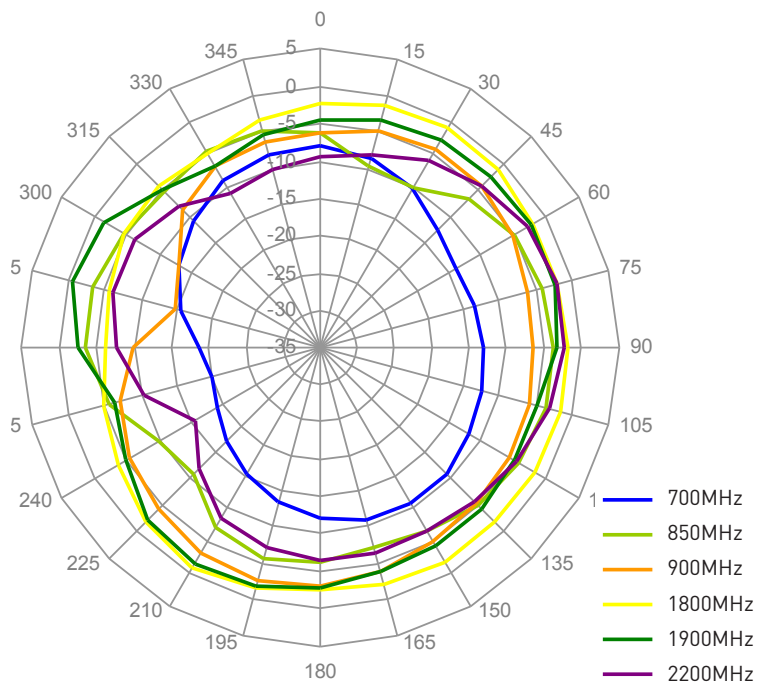

### 5.2 XZ-Plane

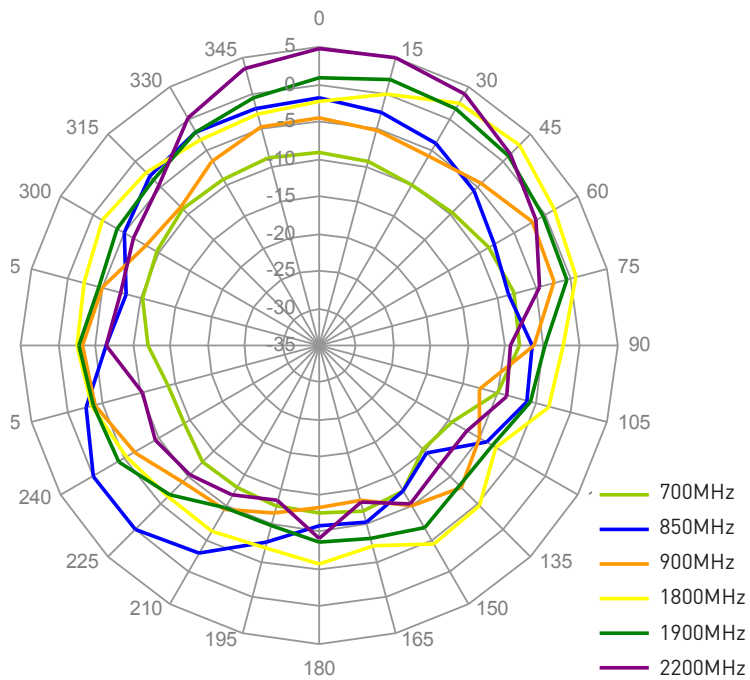

## 6. 2.4/5GHz Antenna Characteristics

### 6.1 S11 Return Loss

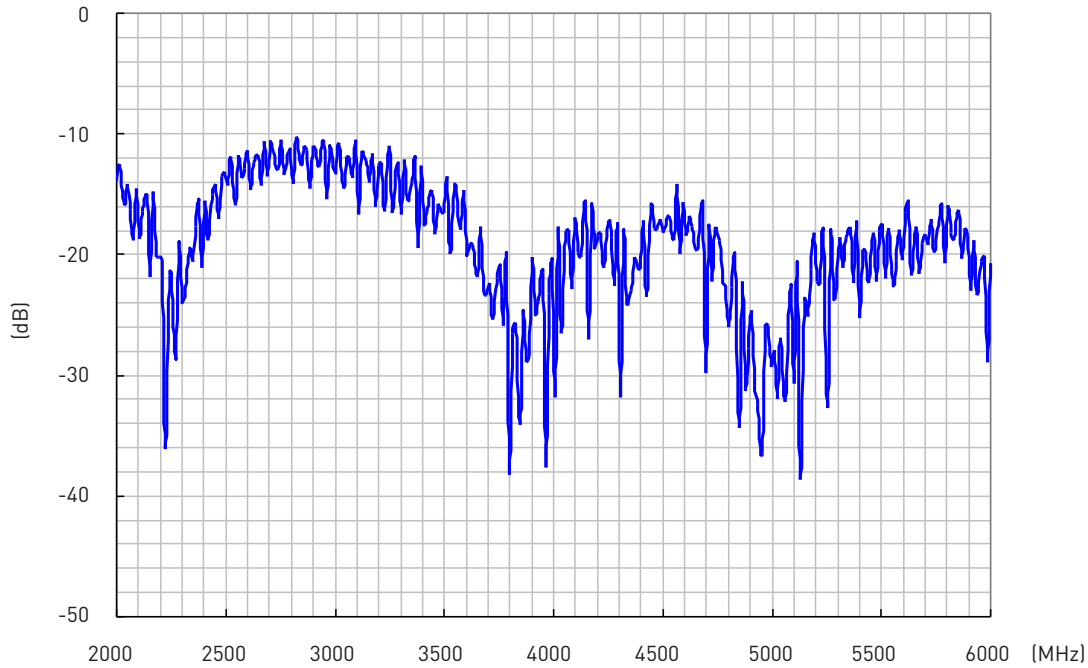

### 6.2 VSWR

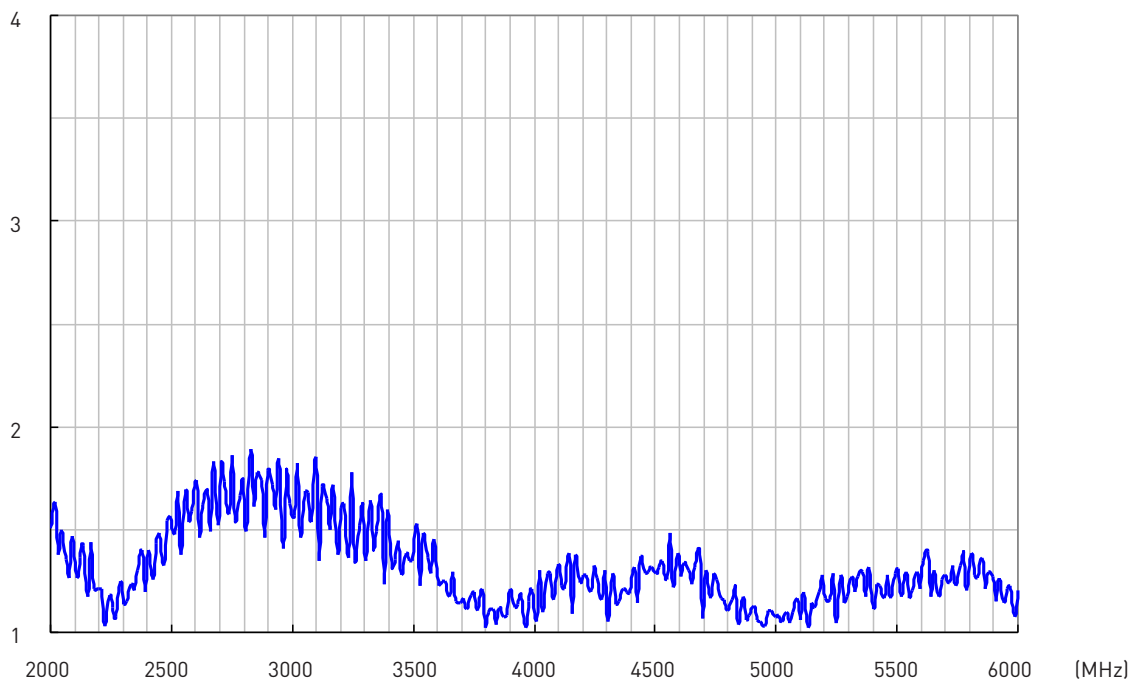

### 6.3 2.4/5GHz Antenna Efficiency

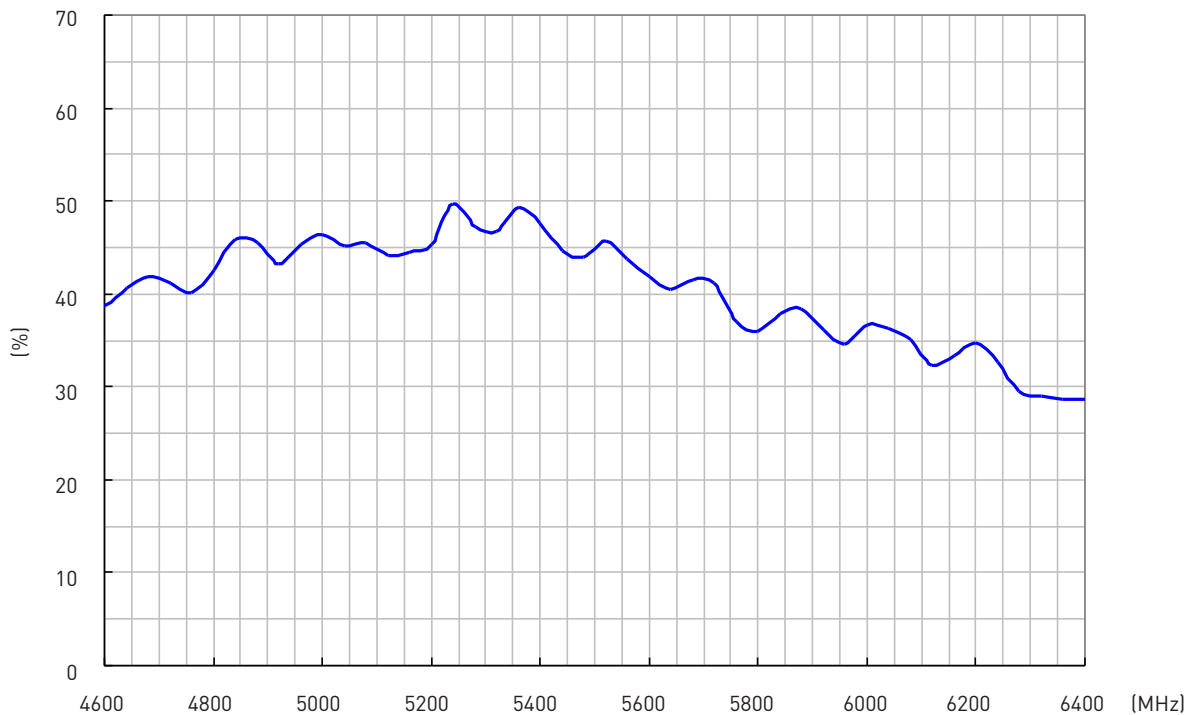
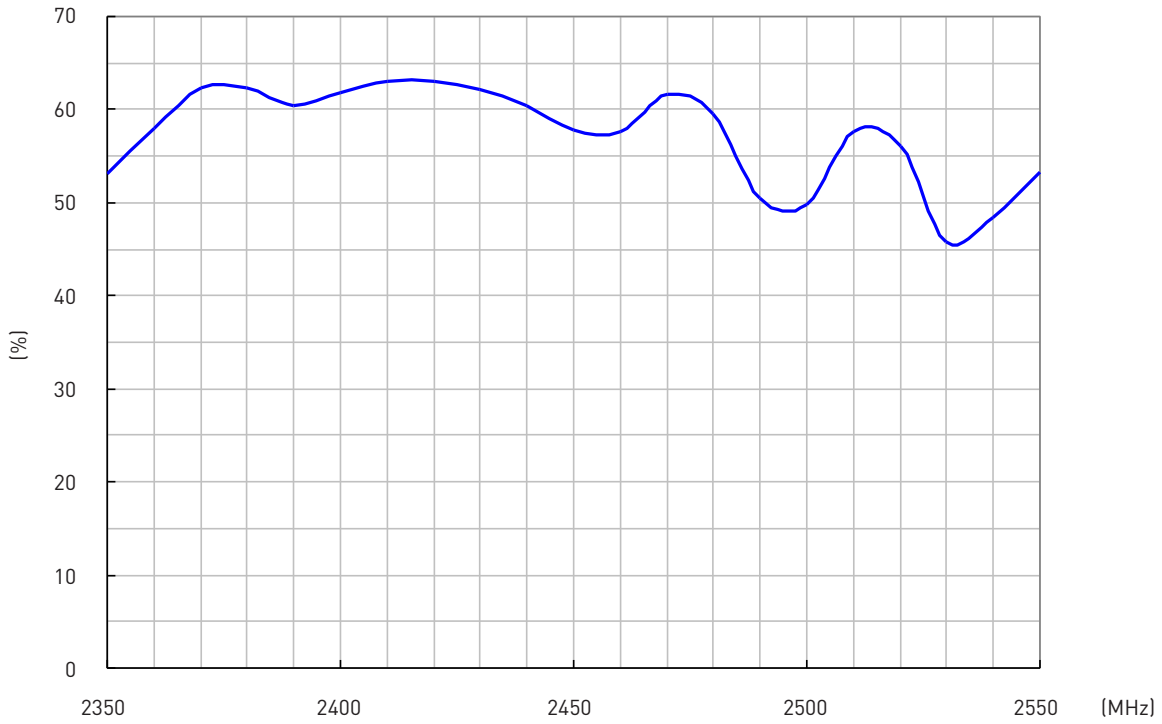

## 6.4 2.4/5GHz Antenna Peak Gain

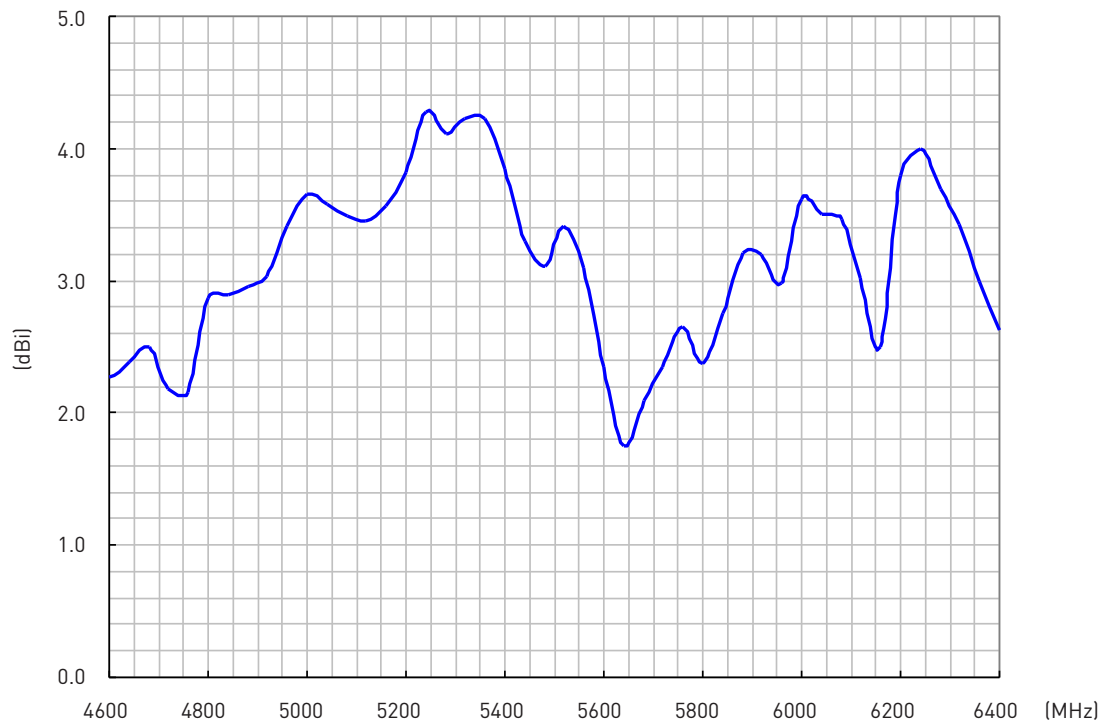
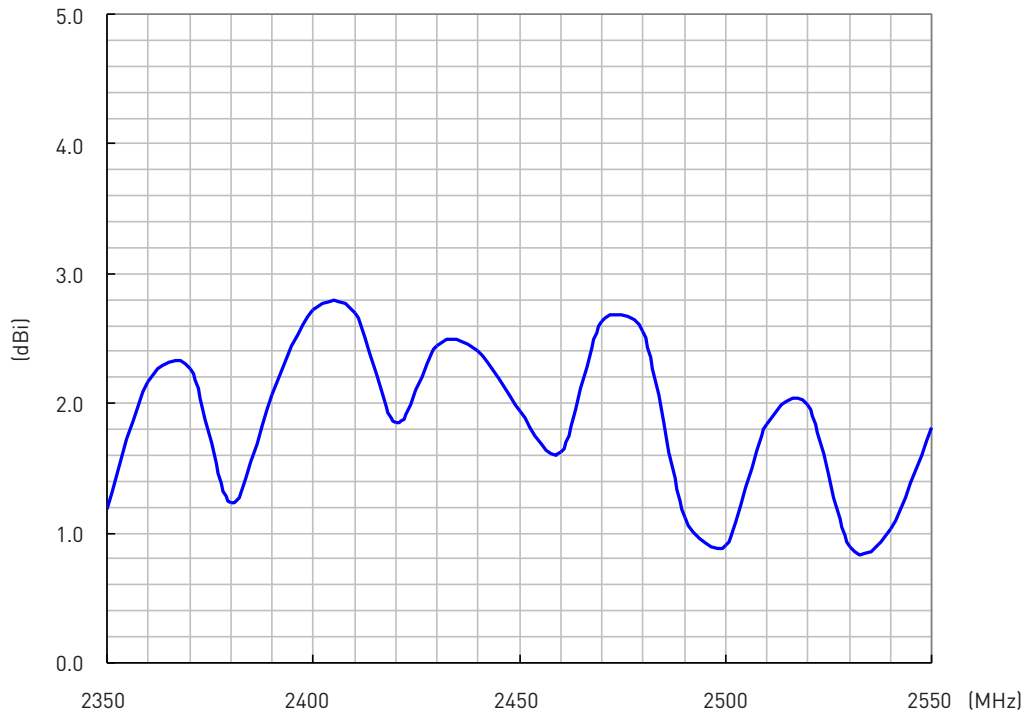

## 6.5 2.4/5GHz Antenna Peak Gain

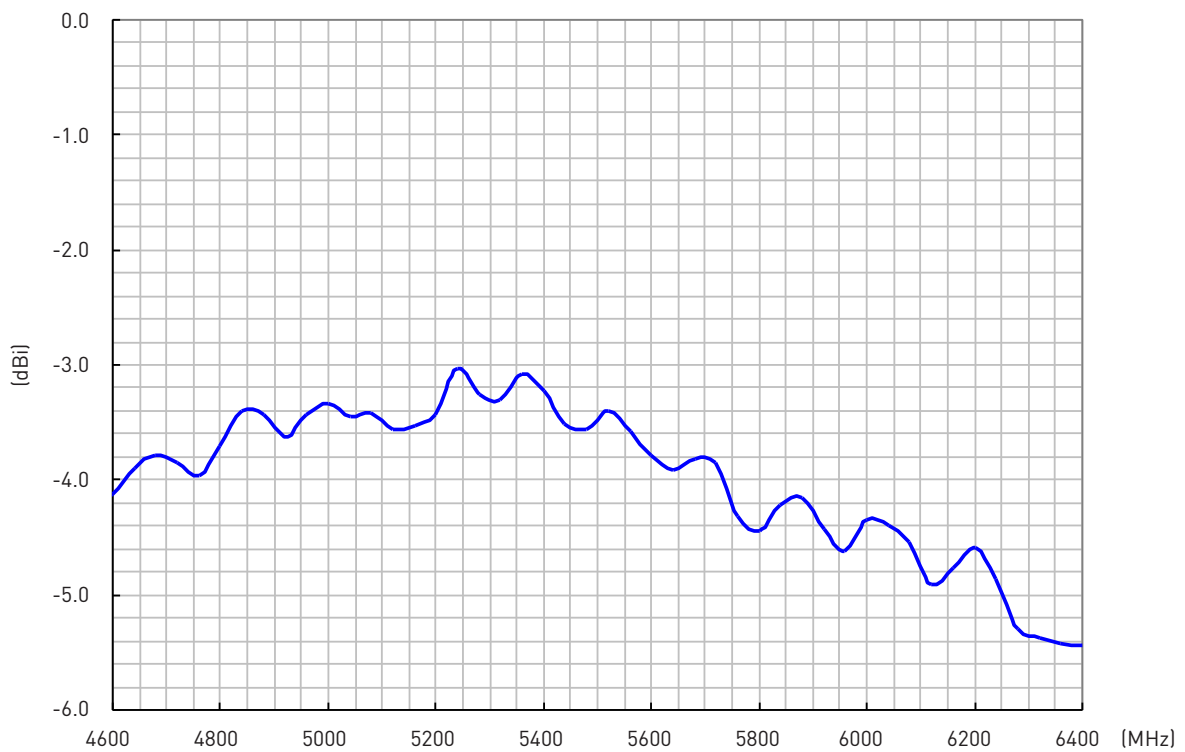
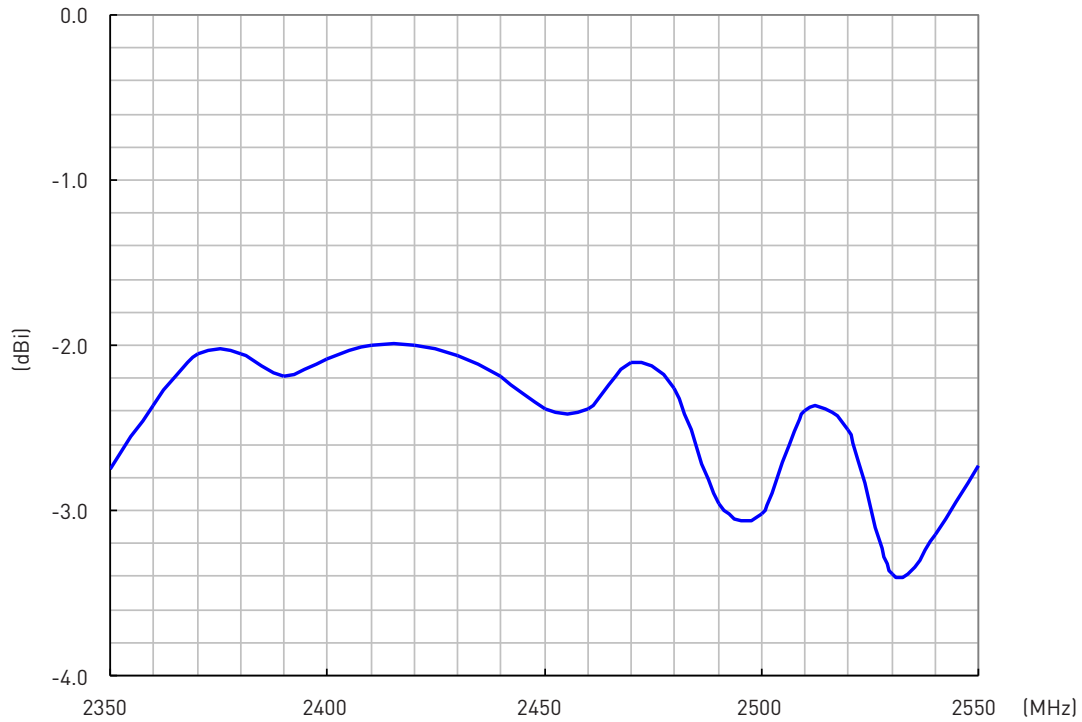



## 7. 2.4/5GHz Antenna Radiation Pattern

### 7.1 XY-plane

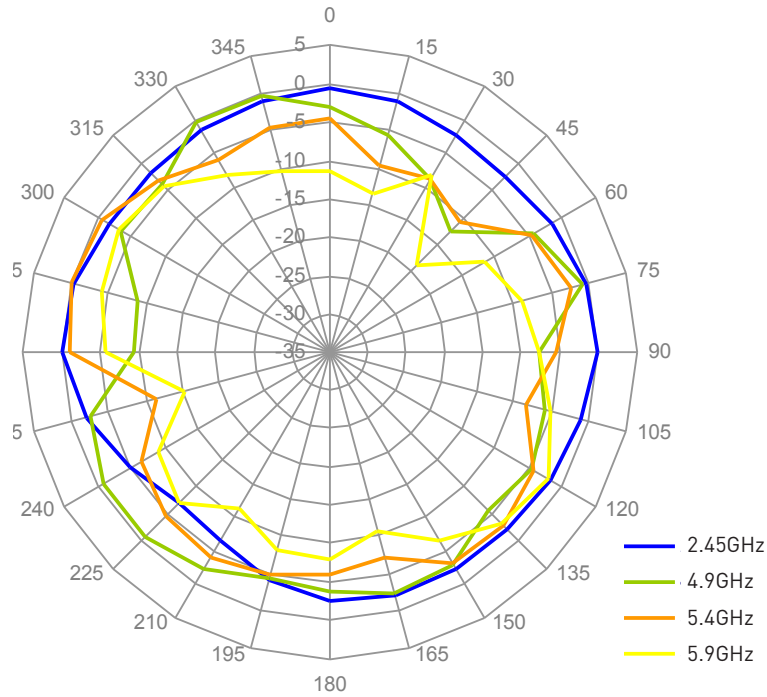

### 7.2 XZ-plane

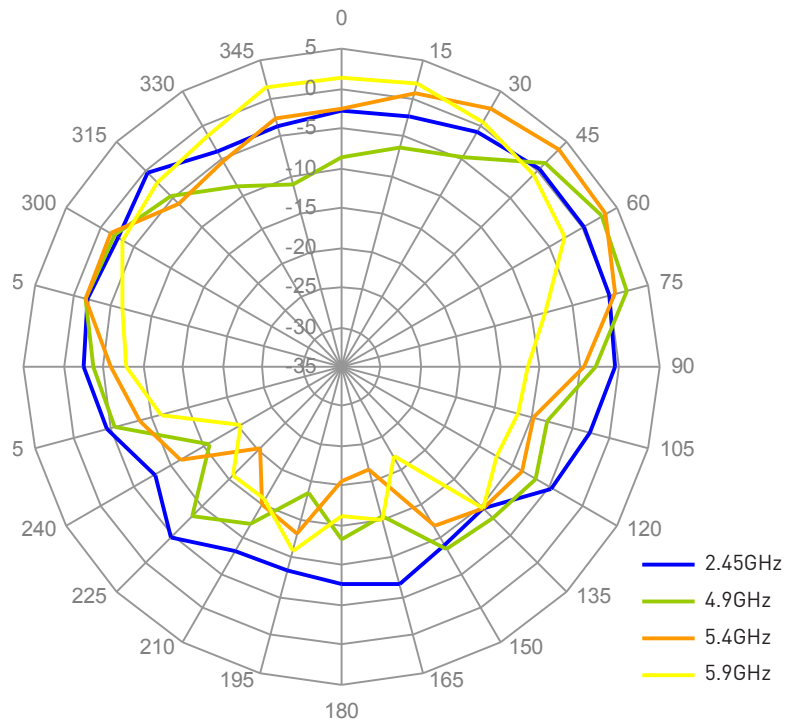

## 8. Mechanical Drawing

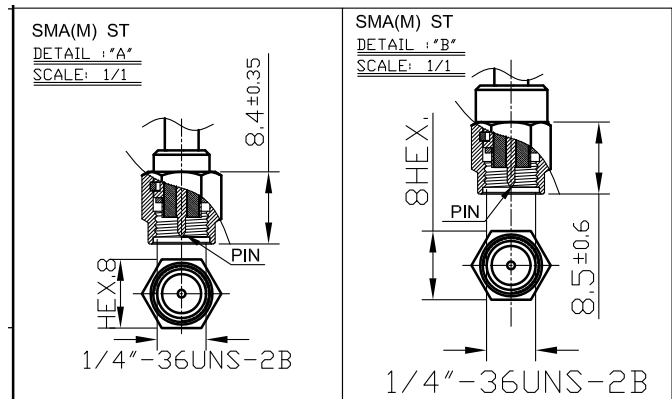
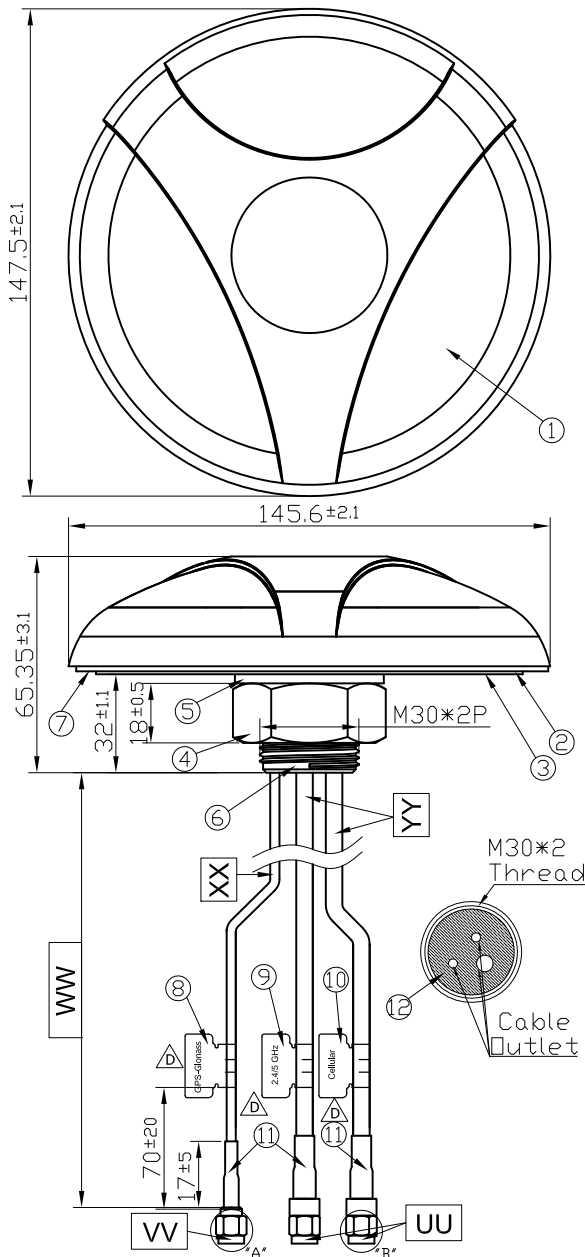

	Name	Material	Finish	QTY
1	Housing	PC 540	White	1
2	Closed Cell Foam	CR 4305	White Liner	1
3	3M Double Adhesive	3M 9448 HK	White Liner	1
4	M30 Nut	Steel AISI 1215	Ni Plated	1
5	Washer	Steel AISI 1215	Ni Plated	1
6	M30x 2 Thread 32L	Zinc Alloy	Ni Plated	1
7	Waterproof Rubber	Silicon	Black	1
8	GPS-Glonass Label	Coated Paper	Orange	1
9	2.4/5GHz Label	Coated Paper	Green	1
10	Cellular Label	Coated Paper	Blue	1
11	Heat Shrink Tube (RG174)	PE	Black	1
12	Rubber Stopper	Silicon Rubber	Black	1
13	Heat Shrink Tube (CFD200)	PE	Black	2

	Name	Spec	Finish	QTY
UU	Connector Type	SMA(M) ST	Gold	2
VV	Connector Type	SMA(M) ST	Gold	1
WW	Cable Length	3000±120mm		1
XX	Cable Type	RG174	Black	1
YY	Cable Type	CFD 200	Black	2

## 8. Mechanical Drawing

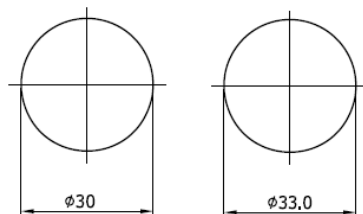
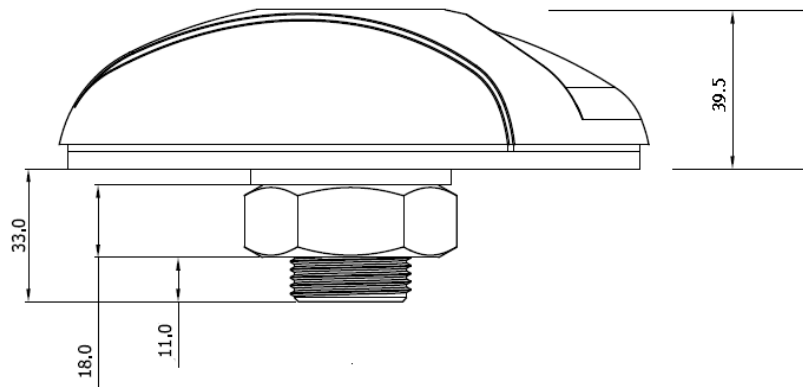
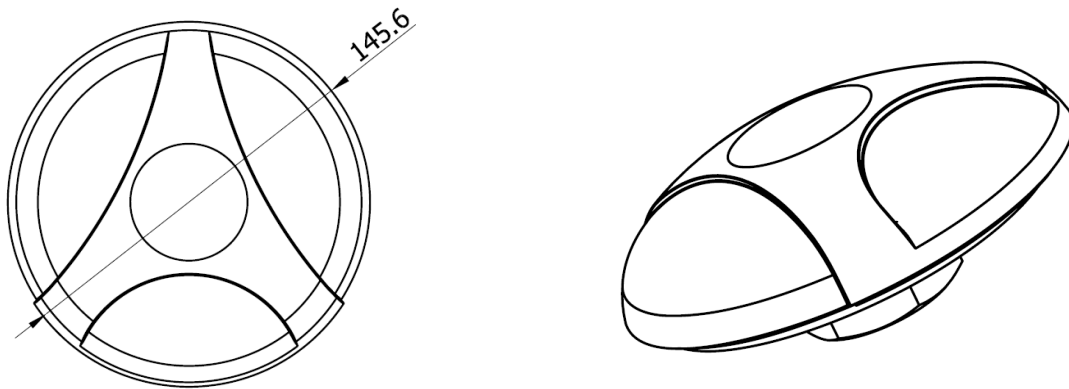

**Thread  
Diameter**

**Recommended  
Mounting Hole**

**Unit: mm**

## 9. Installation

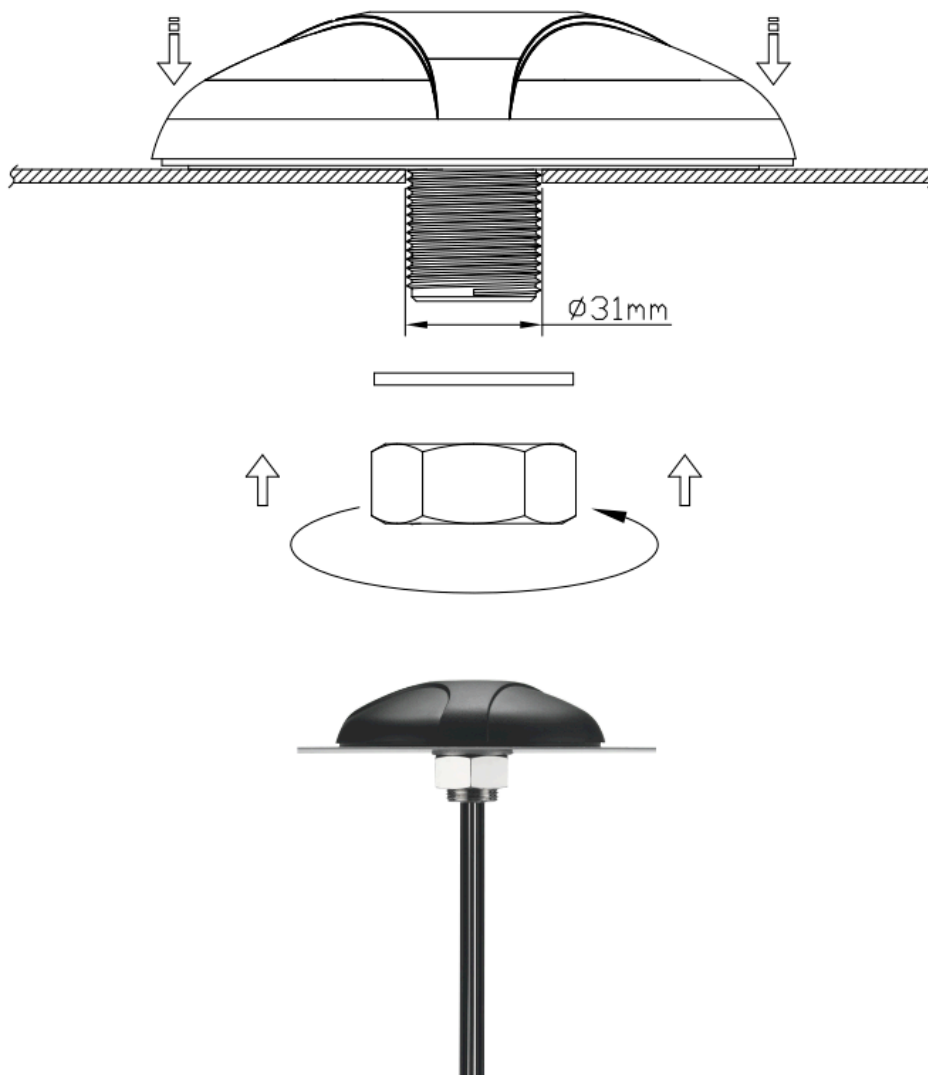

## 10. Packaging

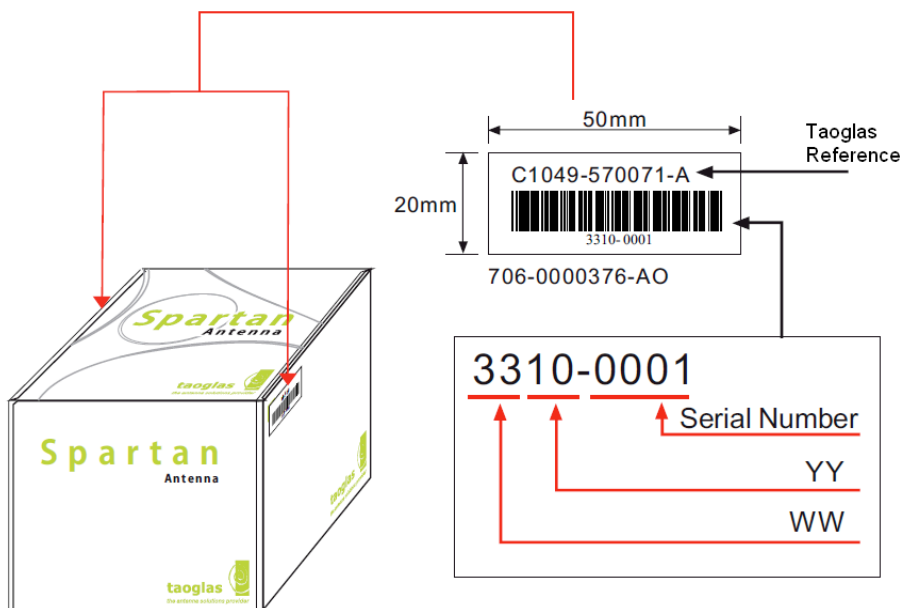
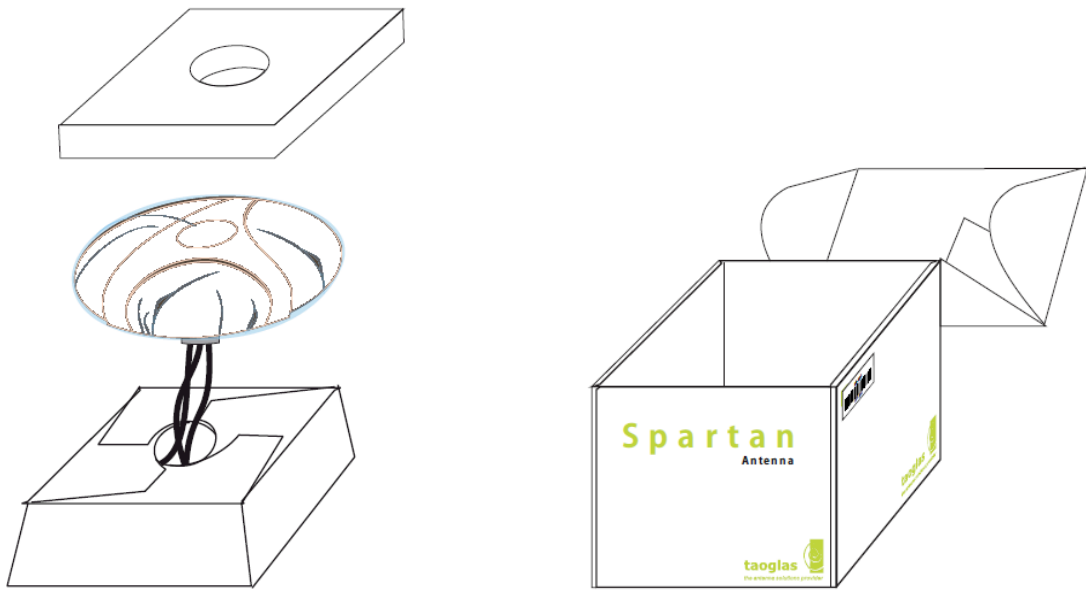

## 10. Packaging

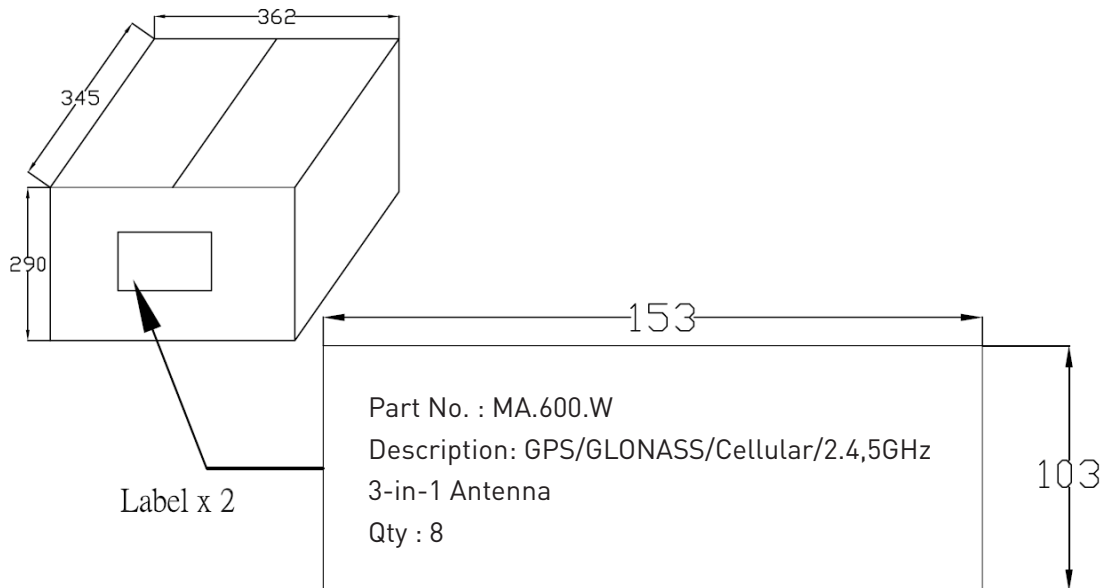

Taoglas makes no warranties based on the accuracy or completeness of the contents of this document and reserves the right to make changes to specifications and

product descriptions at any time without notice. Taoglas reserves all rights to this document and the information contained herein.

Reproduction, use or disclosure to third parties without express permission is strictly prohibited.  
Copyright © Taoglas Ltd.