

## DETAILS

<b>Product Number</b>	CA12050_STRADA-FT
<b>Family</b>	Strada
<b>Type</b>	Assembly
<b>Color</b>	clear
<b>Diameter</b>	19,6 x 15,5 mm
<b>Height</b>	8,35 mm
<b>Style</b>	rectang
<b>Optic Material</b>	PMMA
<b>Holder Material</b>	
<b>Fastening</b>	tape, pin, screw
<b>Status</b>	production ready
<b>ROHS Compliant</b>	Yes
<b>Date Updated</b>	10/05/2017



## OPTICAL PROPERTIES

LED	Viewing	Light	Efficiency	cd/lm	Connector
	Angle	Beam			
XP-E	Asymmetric deg	Asymmetric	92 %	-	-
XP-G	Asymmetric deg	Asymmetric	88 %	-	-
XB-D	Asymmetric deg	Asymmetric	87 %	-	-
H35C0 (LEMWA33)	Asymmetric deg	Asymmetric	86 %	0.510	-
H35B0 (LEMWA32)	Asymmetric deg	Asymmetric	85 %	0.500	-
LUXEON Rebel	Asymmetric deg	Asymmetric	92 %	-	-
LUXEON Rebel ES	Asymmetric deg	Asymmetric	92 %	-	-
LUXEON A	Asymmetric deg	Asymmetric	87 %	-	-
LUXEON Z ES	Asymmetric deg	Asymmetric	86 %	0.610	-
NCSxx19A	Asymmetric deg	Asymmetric	92 %	-	-
NVSxx19A	Asymmetric deg	Asymmetric	92 %	-	-
Oslon SSL 80	Asymmetric deg	Asymmetric	92 %	-	-
Oslon SSL 150	Asymmetric deg	Asymmetric	92 %	-	-
Z5	Asymmetric deg	Asymmetric	92 %	-	-
Z5M1/Z5M2	Asymmetric deg	Asymmetric	87 %	-	-
Double Dome (GM2BB)	Asymmetric deg	Asymmetric	92 %	-	-

D

C

B

A

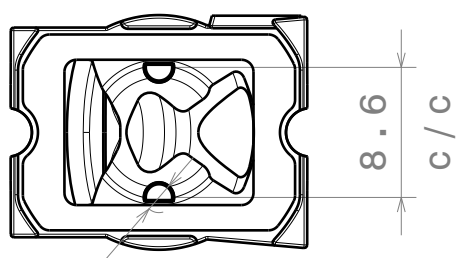
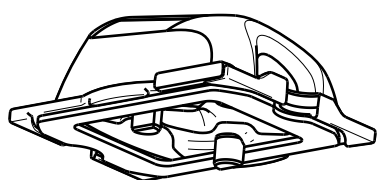

8.2  
without tape  
8.3

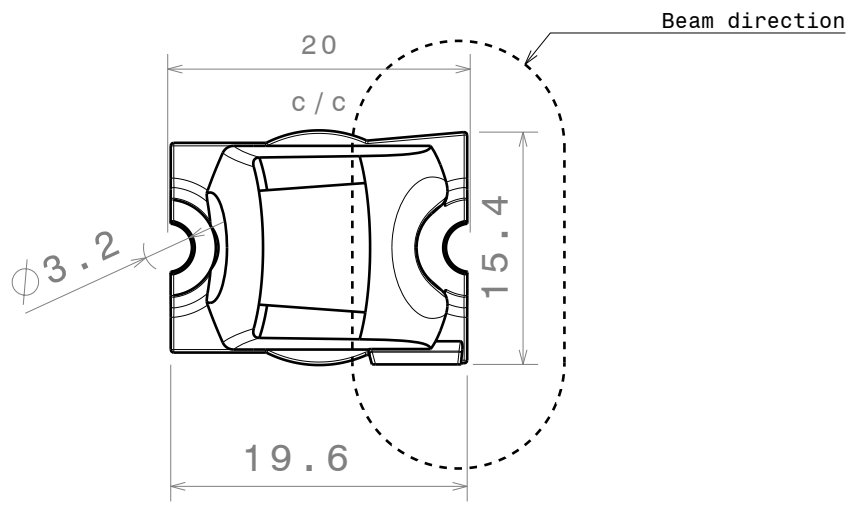
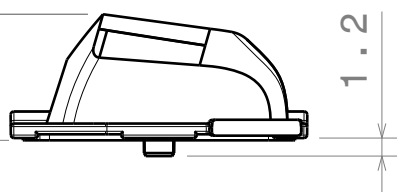

MATERIALS  
Lens: PMMA  
Tape(optional): PU Foam

This drawing is our property.  
It can't be reproduced  
or communicated without  
our written agreement.



DRAWING TITLE

DRAWN BY  
ah

DATE  
3.7.2012

Datasheet Strada-FT-Tape series assy

CHECKED BY  
sn

DATE  
3.7.2012

SIZE  
A4

DRAWING NUMBER

REV  
2

DESIGNED BY  
hh

DATE  
15.3.2011

SCALE 2:1

WEIGHT (g)

SHEET 1/1

D

A

4

4

3

3

2

2

1

1

# Ledil Oy C12049-Strada-FT-XP-G C12049-Strada-FT-XP-G / LDC (Linear)

Luminaire: Ledil Oy C12049-Strada-FT-XP-G C12049-Strada-FT-XP-G  
Lamps: 1 x LED Module

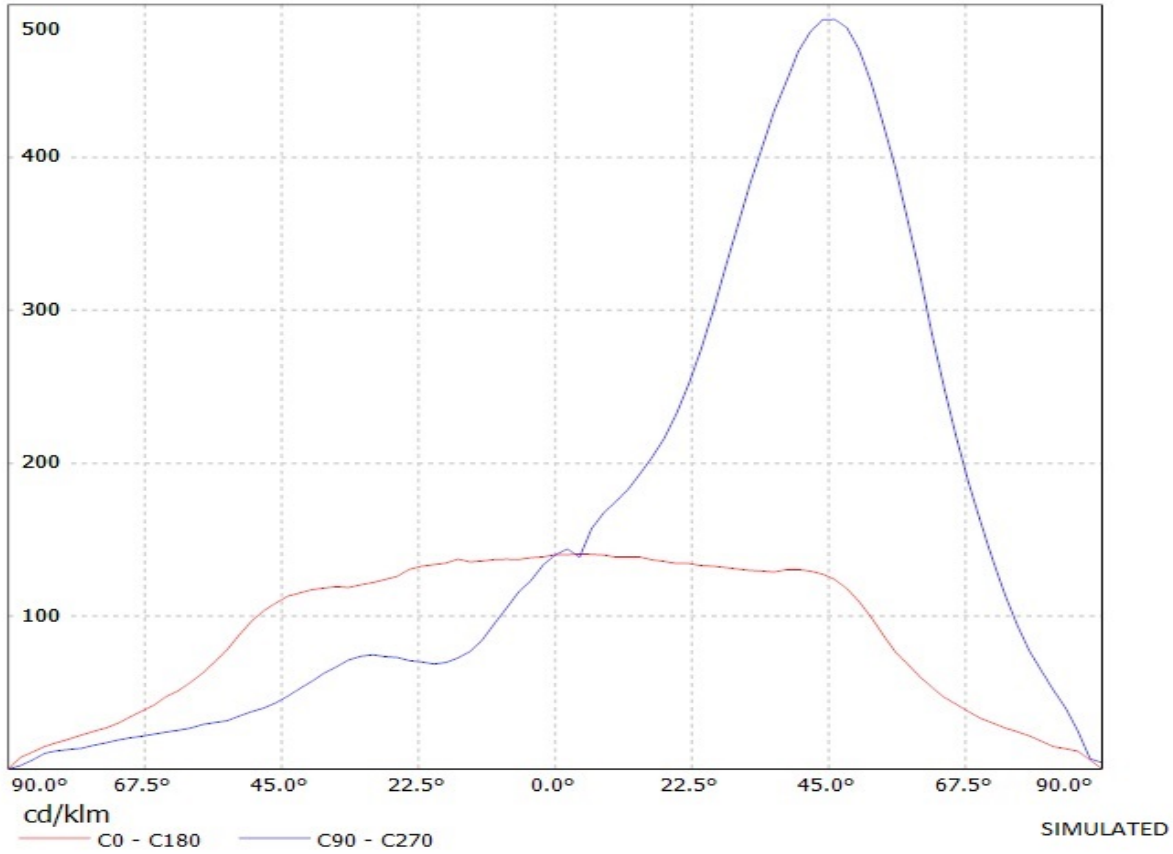

Luminaire: LEDiL CA12050\_STRADA-FT\_(LG3535) Eff. 86%  
Lamps: 1 x LG Ceramic 3535 PKG (95lm@250mA)

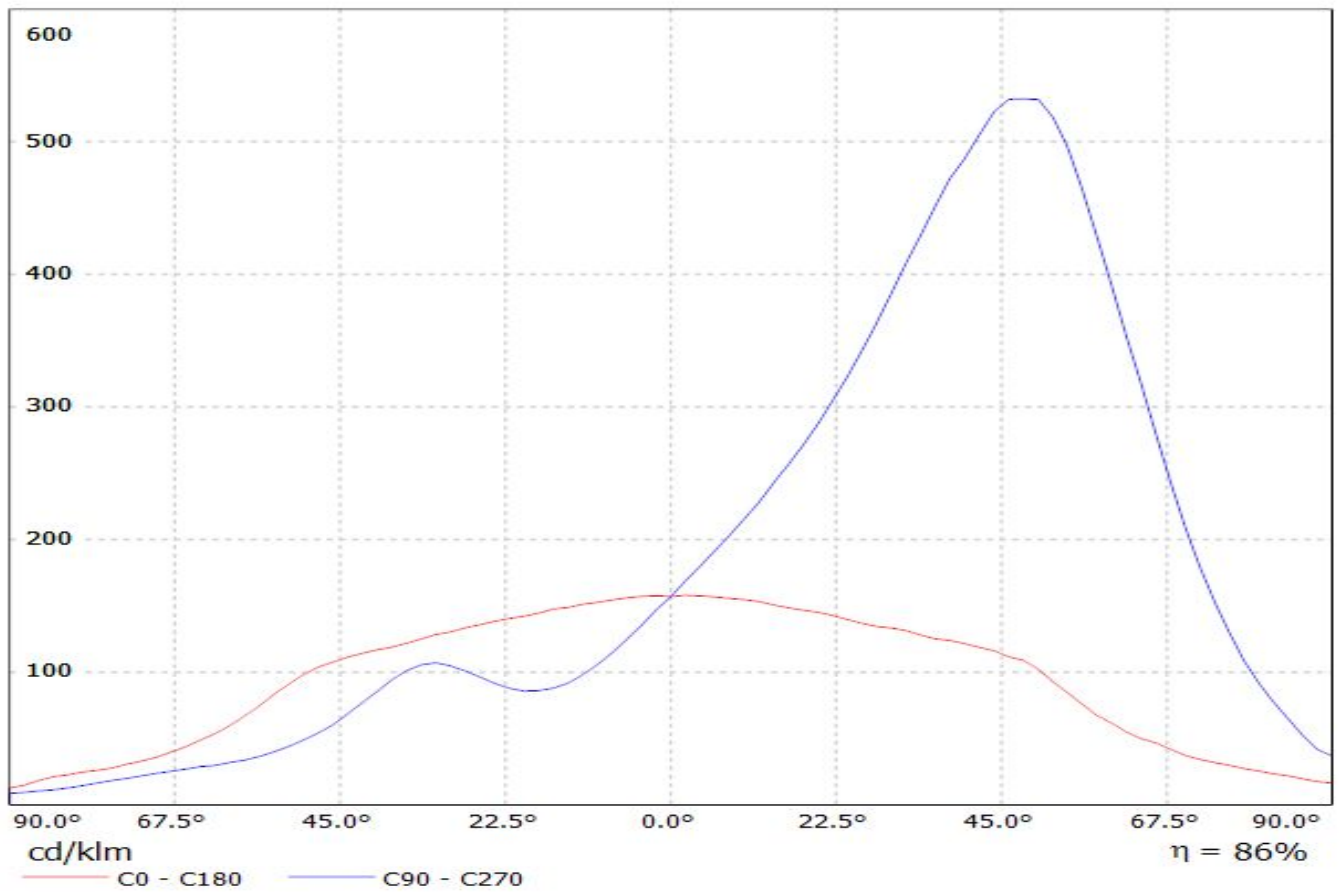

# LEDiL Oy CA12050\_STRADA-FT\_(LG3535\_2W) Eff.84.9% / LDC (Linear)

Luminaire: LEDiL Oy CA12050\_STRADA-FT\_(LG3535\_2W) Eff.84.9%  
Lamps: 1 x LG3535\_2W (97.3629lm@250mA)

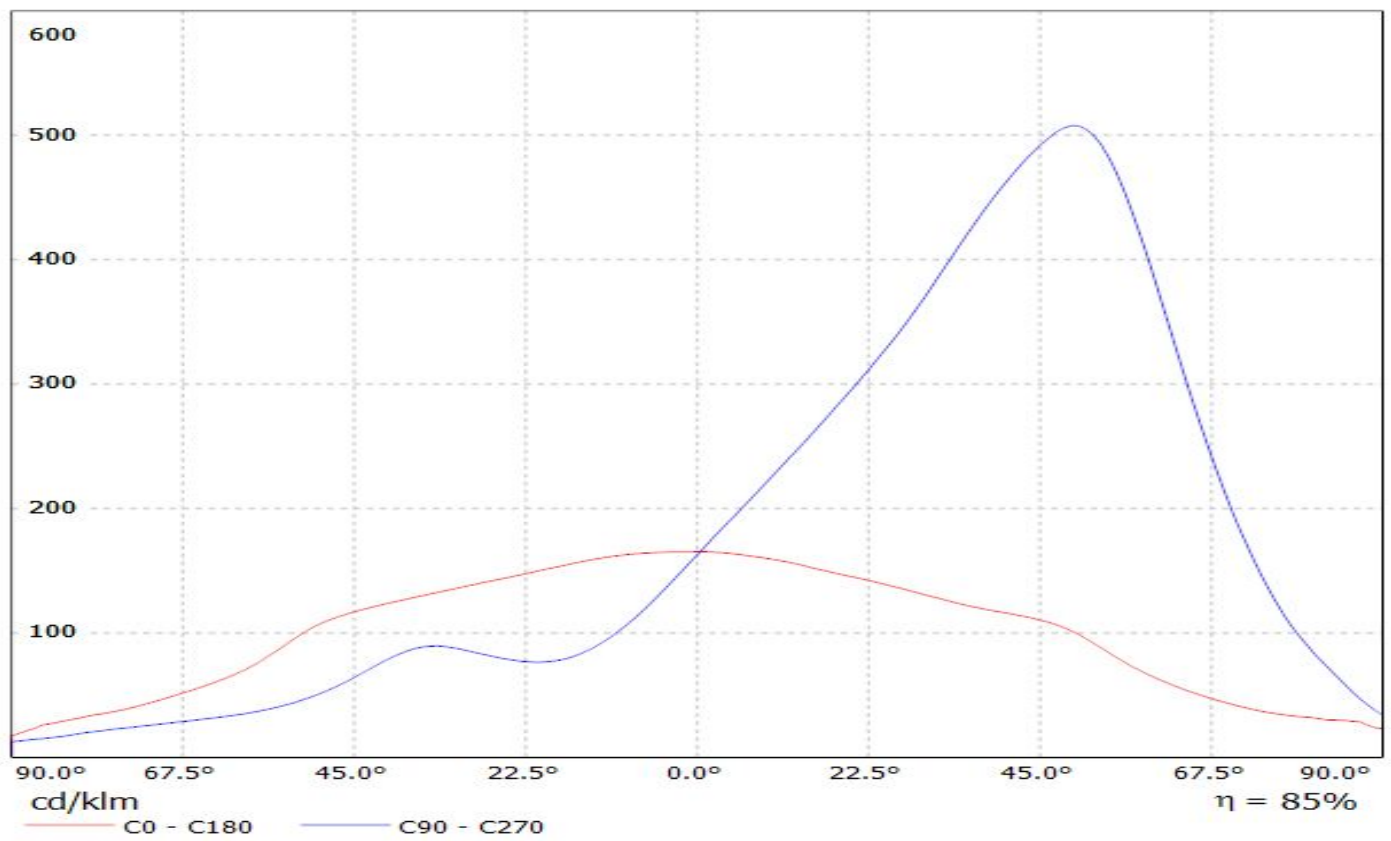

Luminaire: LEDiL Oy CA12050\_STRADA-FT\_(Luxeon\_Z\_ES) Eff.86.4%  
Lamps: 1 x Luxeon\_Z\_ES\_(LXZ2-3090)\_50.8881lm@250mA\_P=0.730433W\_I=249.9mA

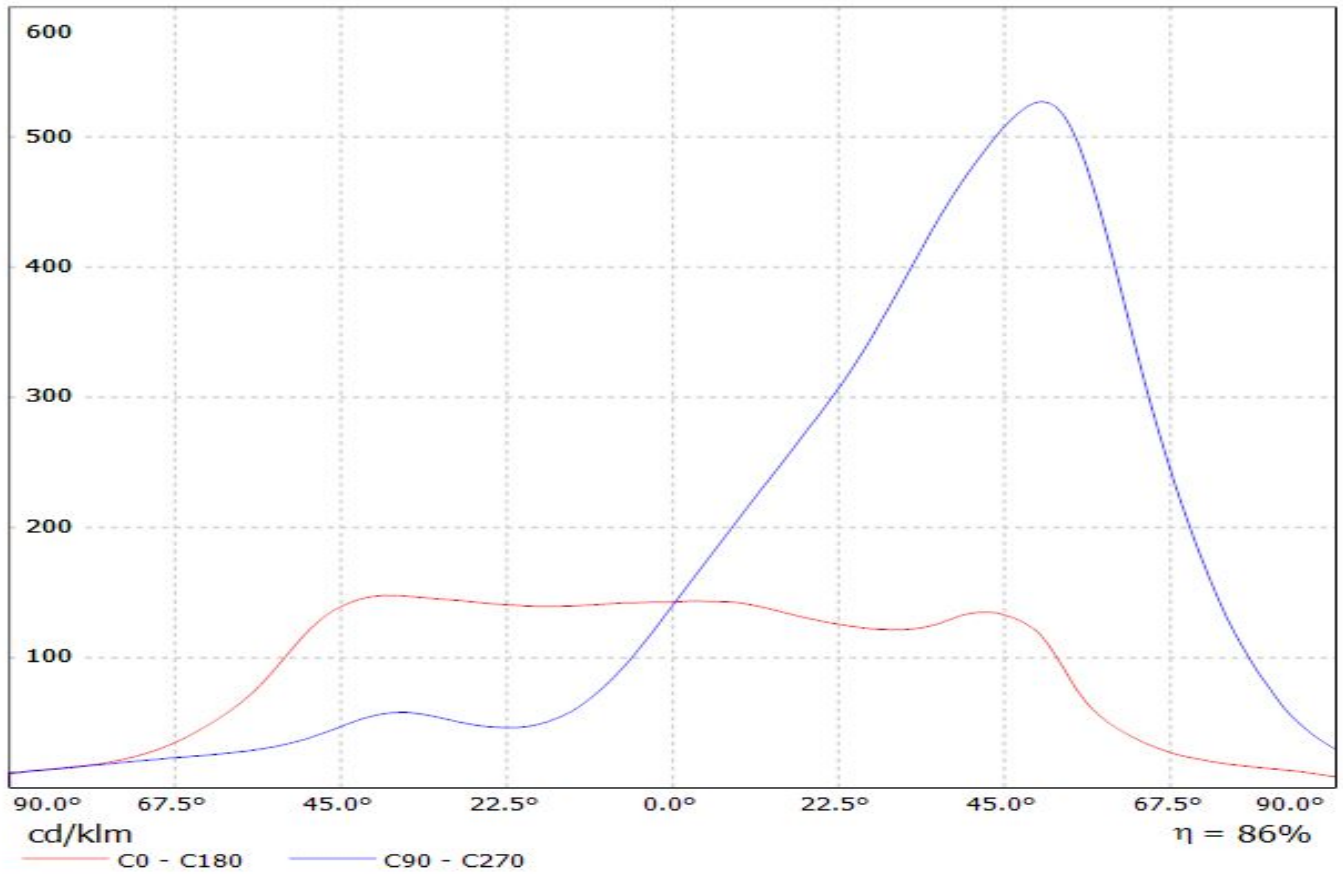

**Ledil Oy CA12050-Strada-FT-Tape-Z5 LOR=92% / LDC (Linear)**

Luminaire: Ledil Oy CA12050-Strada-FT-Tape-Z5 LOR=92%  
Lamps: 1 x Seoul Z5 73lm @ 250mA

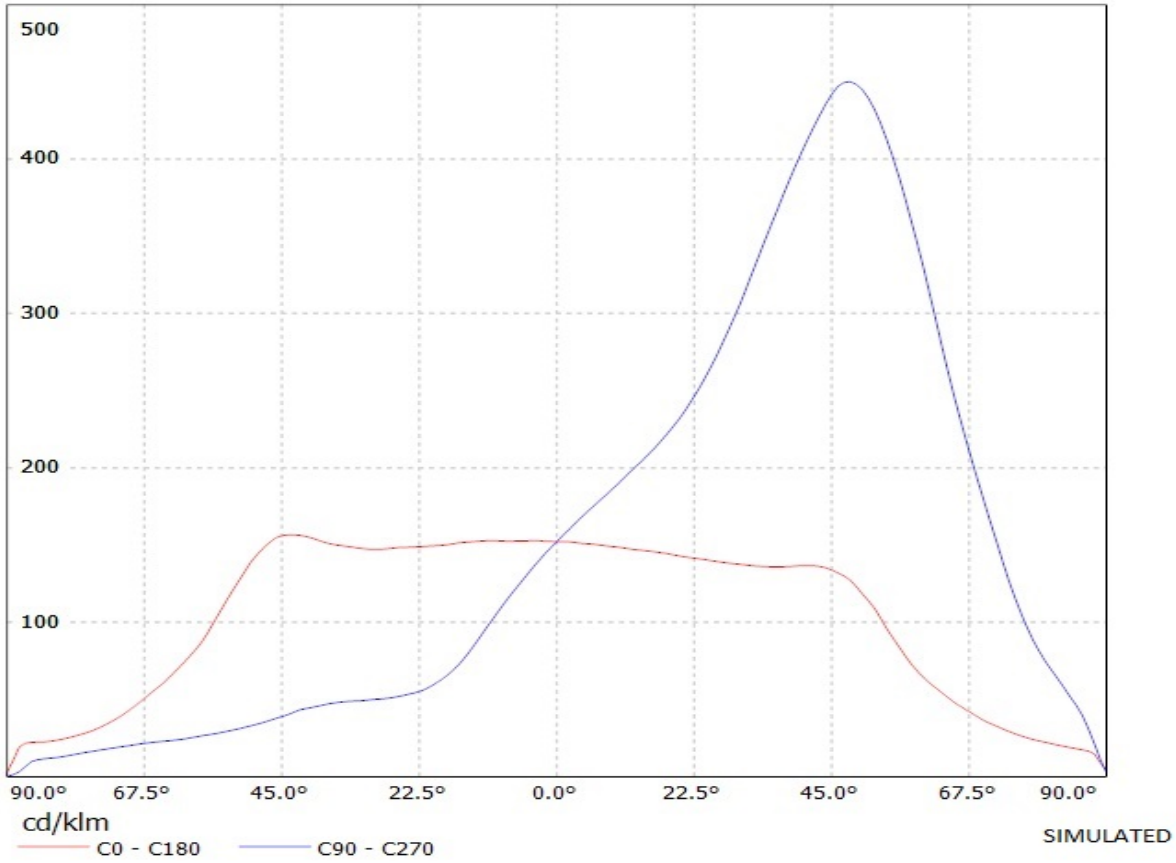

Luminaire: LEDil Oy CA12050\_STRADA-FT\_(Z5M1) Efficiency=87%  
Lamps: 1 x Seoul Z5M1 (SZ5M1-W0-C8/W1-A5-G) 108lm @ 250mA CCT=9100K P=0.8W I=250mA

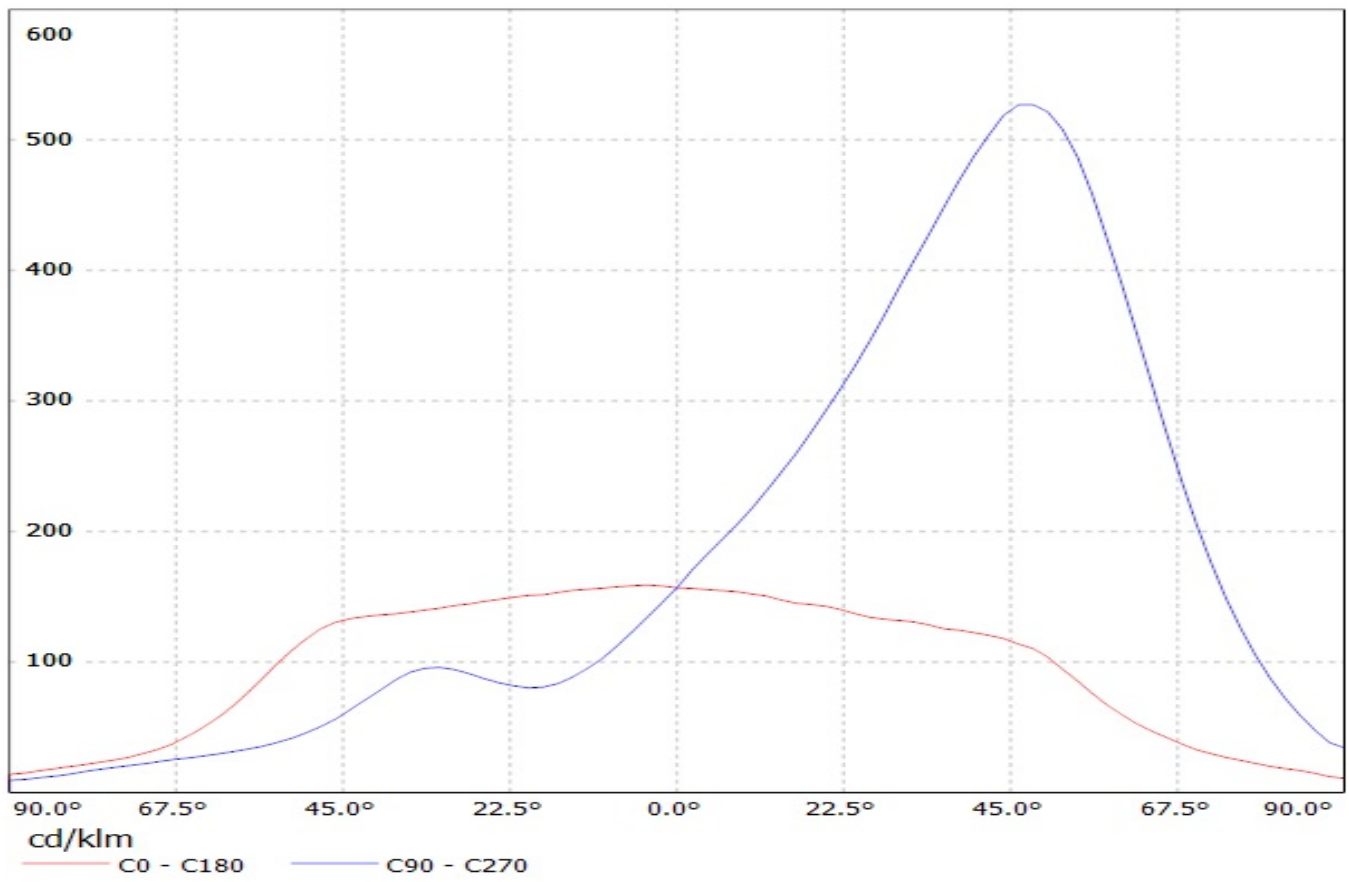



# Ledil Oy C12049-Strada-FT-XP-G C12049-Strada-FT-XP-G / LDC (Polar)

Luminaire: Ledil Oy C12049-Strada-FT-XP-G C12049-Strada-FT-XP-G

Lamps: 1 x LED Module

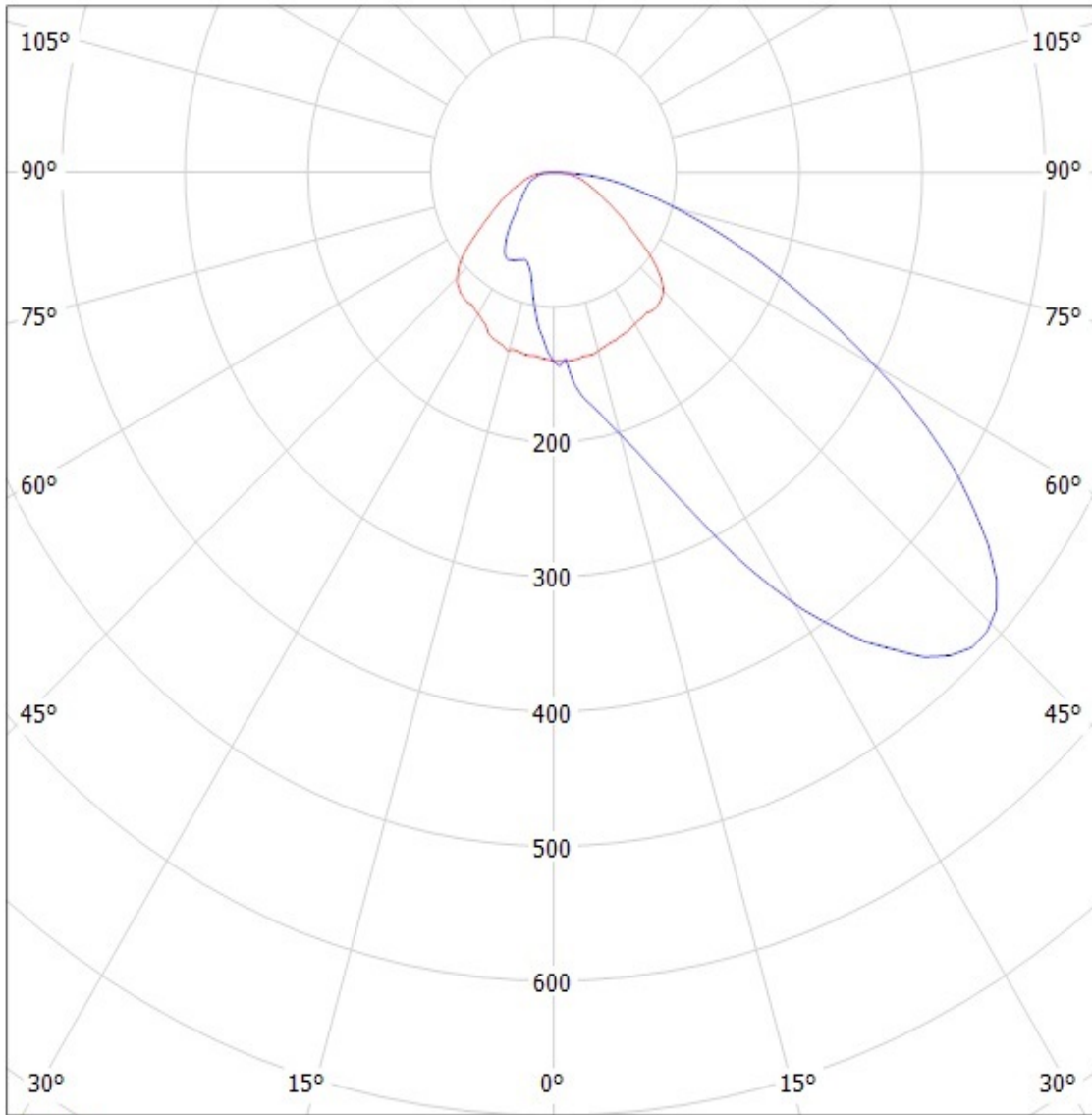

cd/klm

— C0 - C180    — C90 - C270

SIMULATED

Luminaire: LEDiL CA12050\_STRADA-FT\_(LG3535) Eff. 86%  
Lamps: 1 x LG Ceramic 3535 PKG (95lm@250mA)

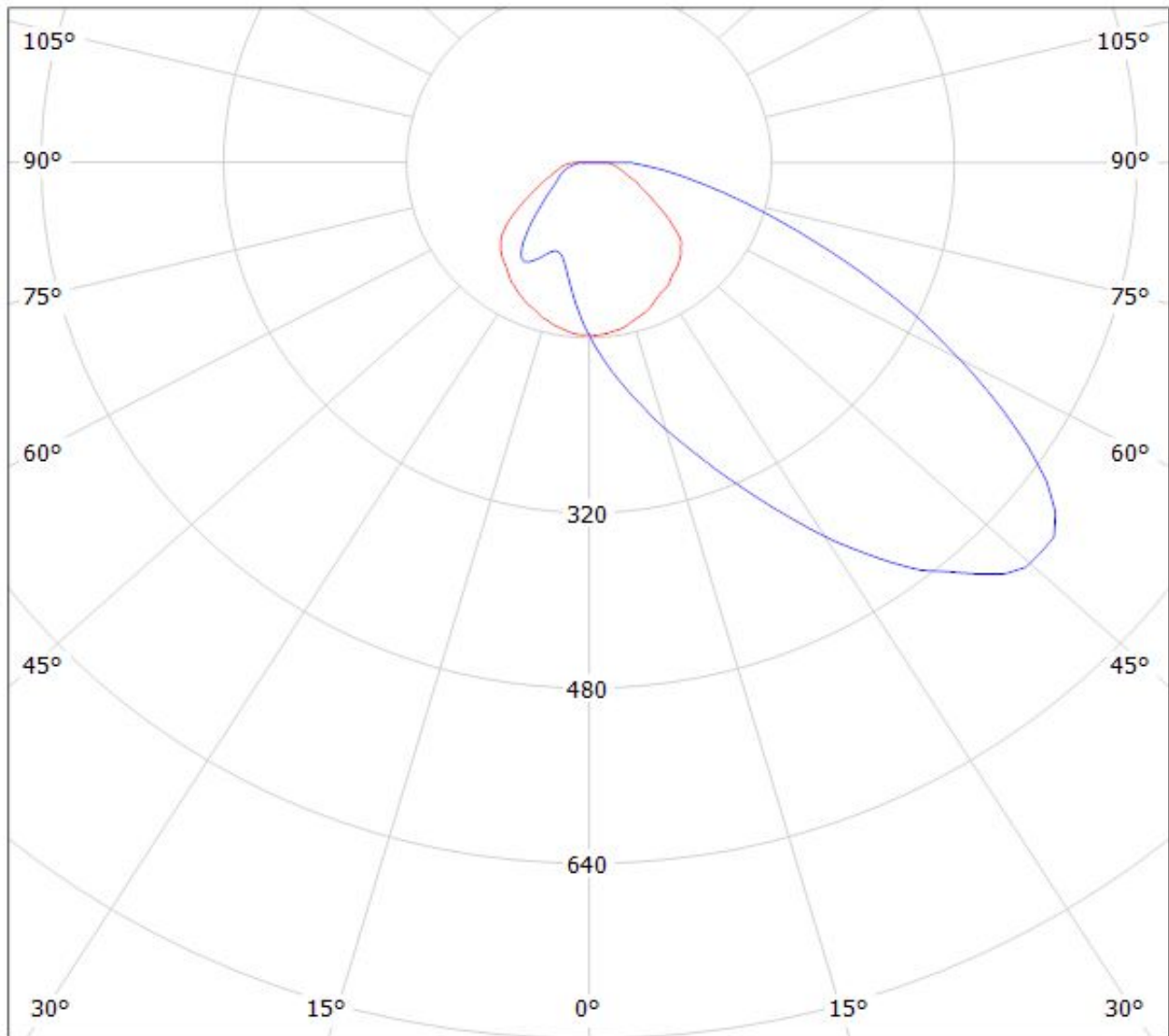

cd/klm

$\eta = 86\%$

— C0 - C180    — C90 - C270

# LEDiL Oy CA12050\_STRADA-FT\_(LG3535\_2W) Eff.84.9% / LDC (Polar)

Luminaire: LEDiL Oy CA12050\_STRADA-FT\_(LG3535\_2W) Eff.84.9%

Lamps: 1 x LG3535\_2W (97.3629lm@250mA)

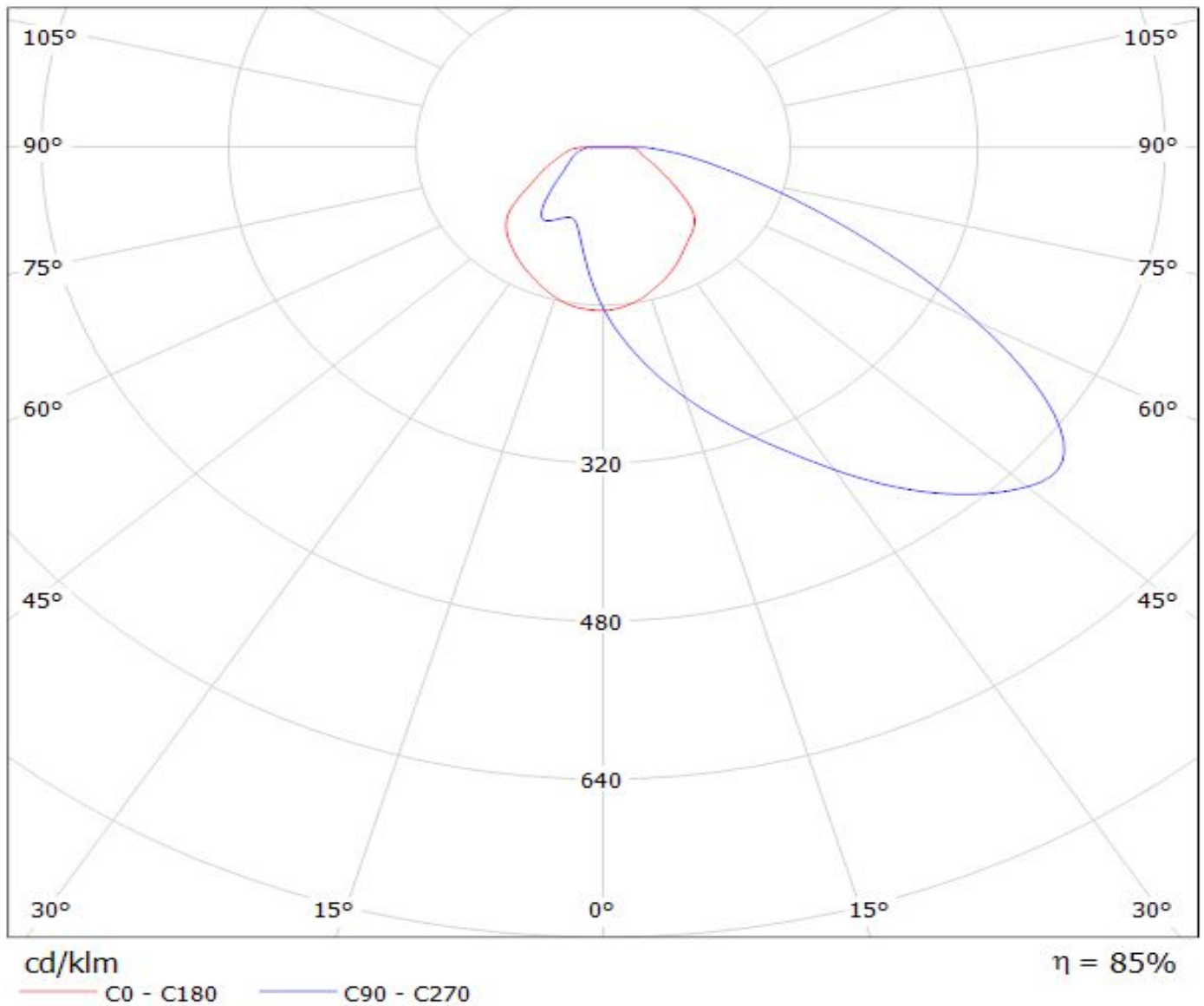

Luminaire: LEDiL Oy CA12050\_STRADA-FT\_(Luxeon\_Z\_ES) Eff.86.4%

Lamps: 1 x Luxeon\_Z\_ES\_(LXZ2-3090)\_50.8881lm@250mA\_P=0.730433W\_I=249.9mA

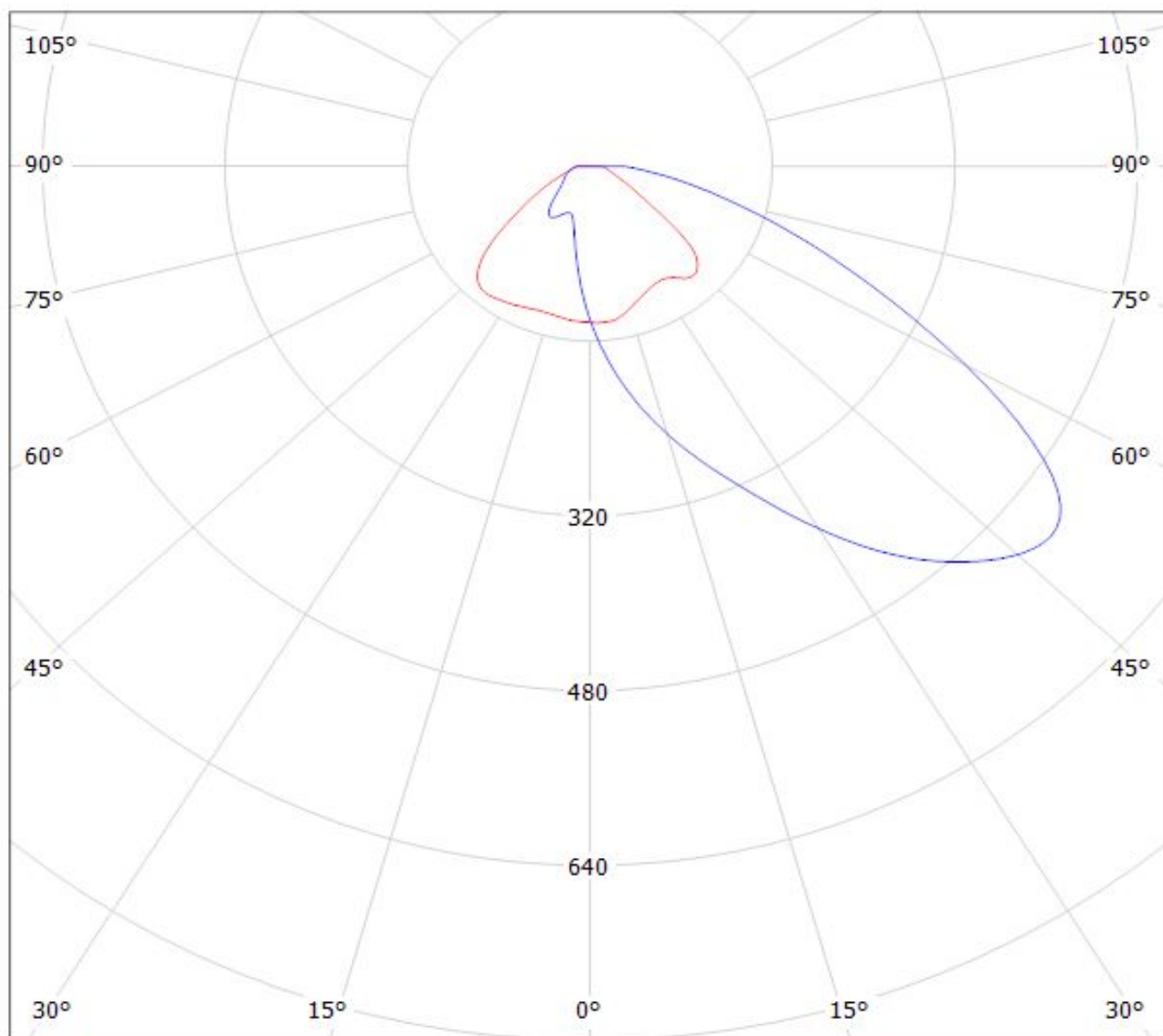

cd/klm

$\eta = 86\%$

— C0 - C180    — C90 - C270

# Ledil Oy CA12050-Strada-FT-Tape-Z5 LOR=92% / LDC (Polar)

Luminaire: Ledil Oy CA12050-Strada-FT-Tape-Z5 LOR=92%

Lamps: 1 x Seoul Z5 73lm @ 250mA

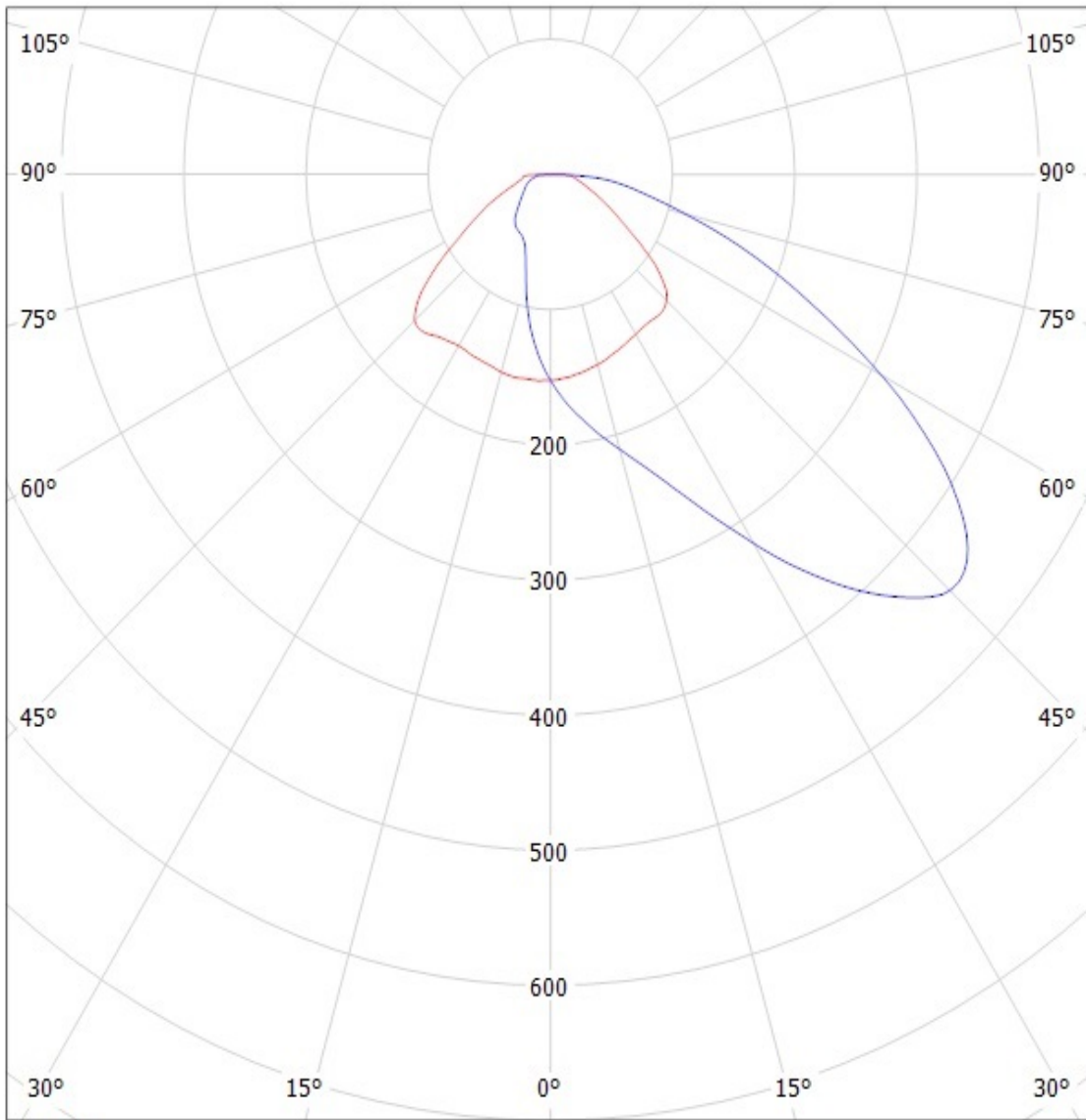

cd/klm

— C0 - C180    — C90 - C270

SIMULATED

Luminaire: LEDil Oy CA12050\_STRADA-FT\_(Z5M1) Efficiency=87%

Lamps: 1 x Seoul Z5M1 (SZ5M1-W0-C8/W1-A5-G) 108lm @ 250mA CCT=9100K P=0.8W I=250mA

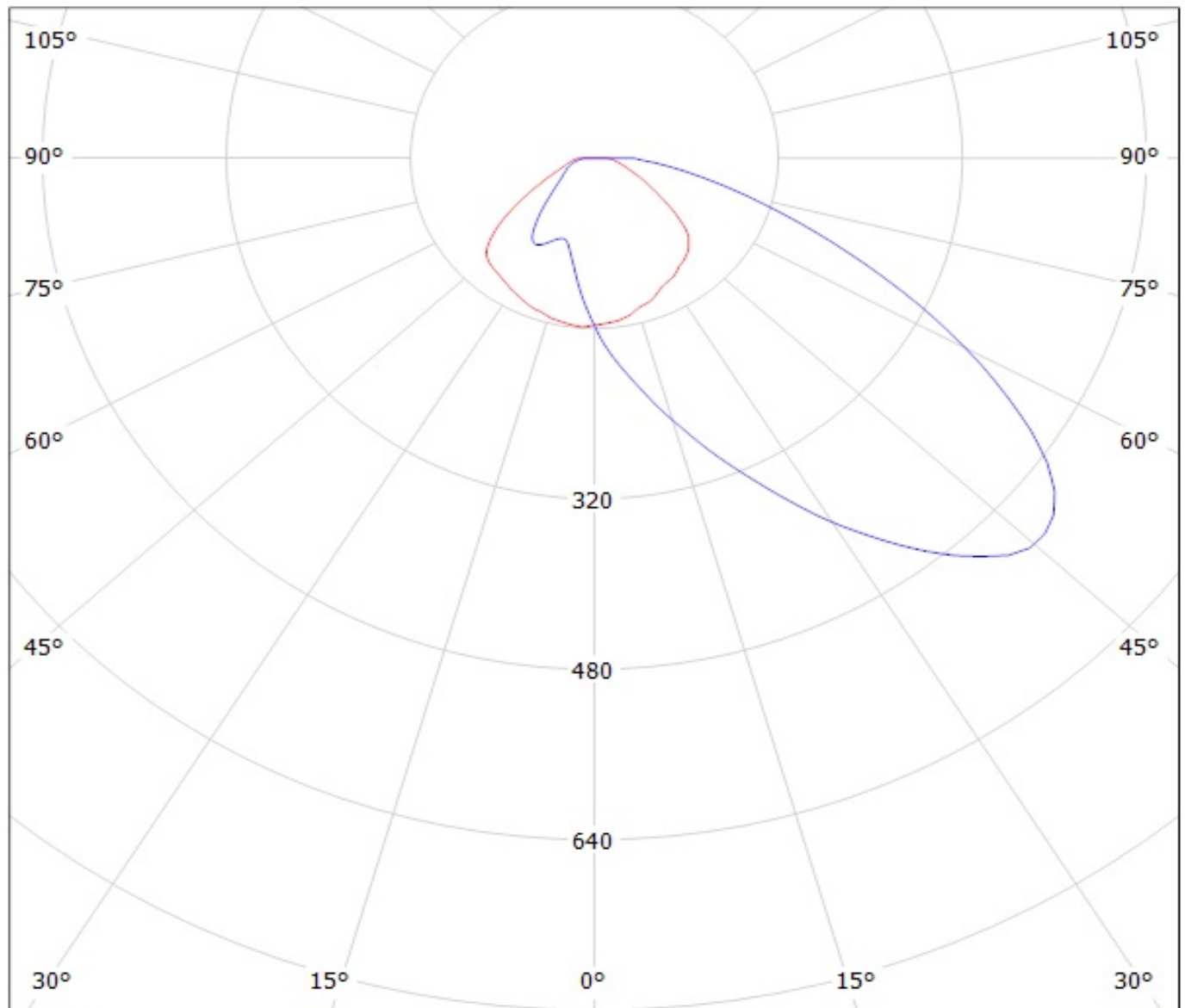

cd/klm

— C0 - C180

— C90 - C270

**NOTE: The typical divergence will be changed by different color, chip size and chip position tolerance. The typical total divergence is the full angle measured where the luminous intensity is half of the peak value.**