

Ordering Information

| Part Number | Marking Code | Nominal Output Voltage 1 | Nominal Output Voltage 2 | Junction Temp. Range | Package | Lead Finish |
|----------------|--------------|--------------------------|--------------------------|----------------------|--|-------------|
| MIC23250-3BYMT | WV3 | 0.9V | 1.1V | -40° to +125°C | 10-Pin 2mm x 2mm Thin MLF [®] | Pb-Free |
| MIC23250-C4YMT | WV2 | 1.2V | 1.0V | -40° to +125°C | 10-Pin 2mm x 2mm Thin MLF [®] | Pb-Free |
| MIC23250-W4YMT | WV4 | 1.2V | 1.6V | -40° to +125°C | 10-Pin 2mm x 2mm Thin MLF [®] | Pb-Free |
| MIC23250-G4YMT | WV5 | 1.2V | 1.8V | -40° to +125°C | 10-Pin 2mm x 2mm Thin MLF [®] | Pb-Free |
| MIC23250-S4YMT | 1WV | 1.2V | 3.3V | -40° to +125°C | 10-Pin 2mm x 2mm Thin MLF [®] | Pb-Free |
| MIC23250-GFHMT | WV1 | 1.575V | 1.8V | -40° to +125°C | 10-Pin 2mm x 2mm Thin MLF [®] | Pb-Free |
| MIC23250-SKYMT | 5WV | 2.6V | 3.3V | -40° to +125°C | 10-Pin 2mm x 2mm Thin MLF [®] | Pb-Free |
| MIC23250-AAYMT | 4WV | ADJ | ADJ | -40° to +125°C | 12-Pin 2.5mm x 2.5mm Thin MLF [®] | Pb-Free |

Notes:

- 1) Additional voltage options available (0.8V to 3.3V). Contact Micrel for details.
- 2) Thin MLF[®] is GREEN RoHS compliant package. Lead finish is NiPdAu. Mold compound is Halogen Free.

Pin Configuration

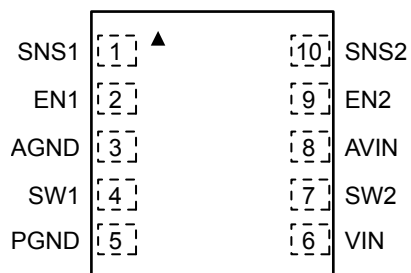

10-Pin 2mm x 2mm Thin MLF[®] (MT)
Fixed Output
(Top View)

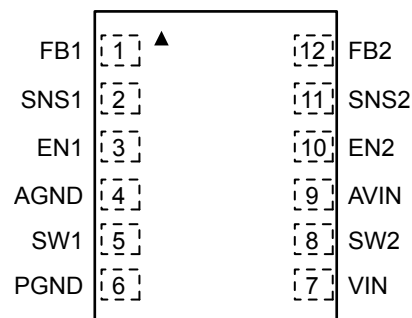

12-Pin 2.5mmx2.5mm Thin MLF[®] (MT)
Adjustable Output
(Top View)

Pin Description

| Pin Number (Fixed) | Pin Number (Adjustable) | Pin Name | Pin Function |
|--------------------|-------------------------|----------|--|
| – | 1 | FB1 | Feedback VOUT1 (Input): Connect resistor divider at this node to set output voltage. Resistors should be selected based on a nominal VFB of 0.72V. |
| 1 | 2 | SNS1 | Sense 1 (Input): Error amplifier input. Connect to feedback resistor network to set output 1 voltage. |
| 2 | 3 | EN1 | Enable 1 (Input): Logic low will shut down output 1. Logic high powers up output 1. Do not leave unconnected. |
| 3 | 4 | AGND | Analog Ground. Must be connected externally to PGND. |
| 4 | 5 | SW1 | Switch Node 1 (Output): Internal power MOSFET output. |
| 5 | 6 | PGND | Power Ground. |
| 6 | 7 | VIN | Supply Voltage (Power Input): Requires close bypass capacitor to PGND. |
| 7 | 8 | SW2 | Switch Node 2 (Output): Internal power MOSFET output. |
| 8 | 9 | AVIN | Supply Voltage (Power Input): Analog control circuitry. Connect to VIN. |
| 9 | 10 | EN2 | Enable 2 (Input): Logic low will shut down output 2. Logic high powers up output 2. Do not leave unconnected. |
| 10 | 11 | SNS2 | Sense 2 (Input): Error amplifier input. Connect to feedback resistor network to set output 2 voltage. |
| – | 12 | FB2 | Feedback VOUT2 (Input): Connect resistor divider at this node to set output voltage. Resistors should be selected based on a nominal VFB of 0.72V. |

Absolute Maximum Ratings⁽¹⁾

| | |
|--|-------------------|
| Supply Voltage (V_{IN})..... | 6V |
| Output Switch Voltage (V_{SW})..... | 6V |
| Logic Input Voltage (V_{EN1} , V_{EN2})..... | -0.3V to V_{IN} |
| Storage Temperature Range (T_s)..... | -65°C to +150°C |
| ESD Rating ⁽³⁾ | 2kV |

Operating Ratings⁽²⁾

| | |
|--|------------------------|
| Supply Voltage (V_{IN})..... | 2.7V to 5.5V |
| Logic Input Voltage (V_{EN1} , V_{EN2})..... | 0V to V_{IN} |
| Junction Temperature (T_J)..... | -40°C ≤ T_J ≤ +125°C |
| Thermal Resistance | |
| 2mm x 2mm Thin MLF-10 (θ_{JA})..... | 70°C/W |
| 2.5mm x 2.5mm Thin MLF-12 (θ_{JA})..... | 65°C/W |

Electrical Characteristics⁽⁴⁾

$T_A = 25^\circ\text{C}$ with $V_{IN} = V_{EN1} = V_{EN2} = 3.6\text{V}$; $L = 1\mu\text{H}$; $C_{OUT} = 4.7\mu\text{F}$; $I_{OUT} = 20\text{mA}$; only one channel power is enabled, unless otherwise specified. **Bold** values indicate $-40^\circ\text{C} \leq T_J \leq +125^\circ\text{C}$.

| Parameter | Condition | Min | Typ | Max | Units |
|--------------------------------------|---|--------------|-------|-------------|------------------|
| Under-Voltage Lockout Threshold | (turn-on) | 2.45 | 2.55 | 2.65 | V |
| UVLO Hysteresis | | | 60 | | mV |
| Quiescent Current | $V_{OUT1,2}$ (both Enabled), $I_{OUT1,2} = 0\text{mA}$, $V_{SNS1,2} > 1.2 * V_{OUT1,2}$ Nominal | | 33 | 50 | μA |
| Shutdown Current | $V_{EN1,2} = 0\text{V}$; $V_{IN} = 5.5\text{V}$ | | 0.01 | 4 | μA |
| Output Voltage Accuracy | $V_{IN} = 3.6\text{V}$ if $V_{OUTNOM} < 2.5\text{V}$, $I_{LOAD} = 20\text{mA}$ | -2.5 | | +2.5 | % |
| | $V_{IN} = 4.5\text{V}$ if $V_{OUTNOM} \geq 2.5\text{V}$, $I_{LOAD} = 20\text{mA}$ | -2.5 | | +2.5 | % |
| Feedback Voltage (Adj only) | | | 0.720 | | V |
| Current Limit in PWM Mode | $SNS = 0.9 * V_{OUTNOM}$ | 0.410 | 0.65 | 1 | A |
| Output Voltage Line Regulation | $V_{IN} = 3.6\text{V}$ to 5.5V if $V_{OUTNOM} < 2.5\text{V}$, $I_{LOAD} = 20\text{mA}$ | | 0.4 | | %/V |
| | $V_{IN} = 4.5\text{V}$ to 5.5V if $V_{OUTNOM} \geq 2.5\text{V}$, $I_{LOAD} = 20\text{mA}$ | | 0.4 | | %/V |
| Output Voltage Load Regulation | $20\text{mA} < I_{LOAD} < 400\text{mA}$, $V_{IN} = 3.6\text{V}$ if $V_{OUTNOM} < 2.5\text{V}$ | | 0.5 | | % |
| | $20\text{mA} < I_{LOAD} < 400\text{mA}$, $V_{IN} = 5.0\text{V}$ if $V_{OUTNOM} \geq 2.5\text{V}$ | | 0.5 | | % |
| PWM Switch ON-Resistance | $I_{SW} = 100\text{mA}$ PMOS | | 0.6 | | Ω |
| | $I_{SW} = -100\text{mA}$ NMOS | | 0.8 | | Ω |
| Frequency | $I_{LOAD} = 120\text{mA}$ | | 4 | | MHz |
| Soft Start Time | $V_{OUT} = 90\%$ | | 260 | | μs |
| Enable Threshold | | 0.5 | 0.8 | 1.2 | V |
| Enable Input Current | | | 0.1 | 2 | μA |
| Over-temperature Shutdown | | | 160 | | $^\circ\text{C}$ |
| Over-temperature Shutdown Hysteresis | | | 40 | | $^\circ\text{C}$ |

Notes:

- Exceeding the absolute maximum rating may damage the device.
- The device is not guaranteed to function outside its operating rating.
- Devices are ESD sensitive. Handling precautions recommended. Human body model: 1.5k Ω in series with 100pF.
- Specification for packaged product only.

Typical Characteristics

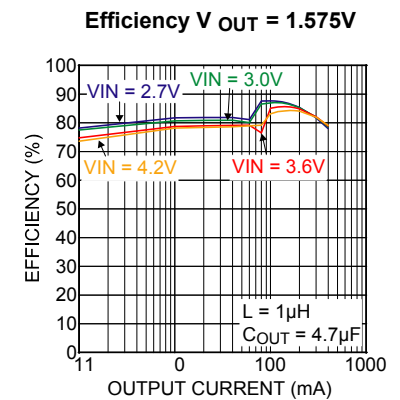
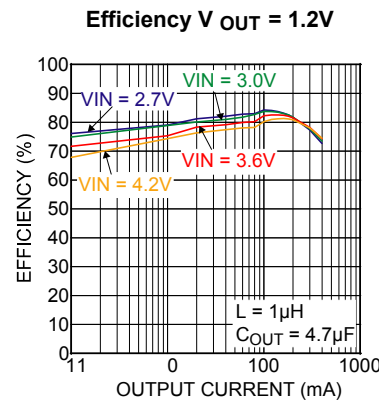
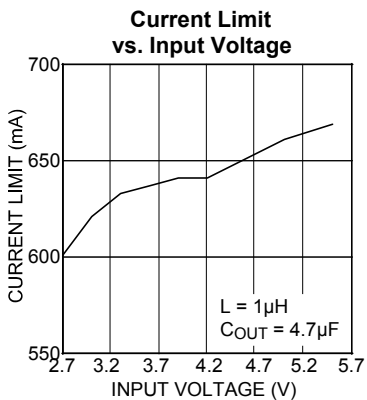
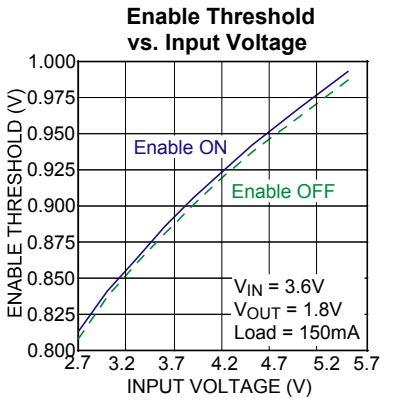
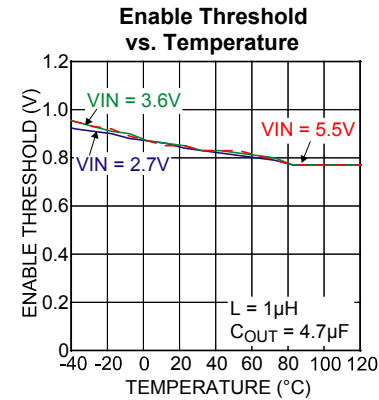
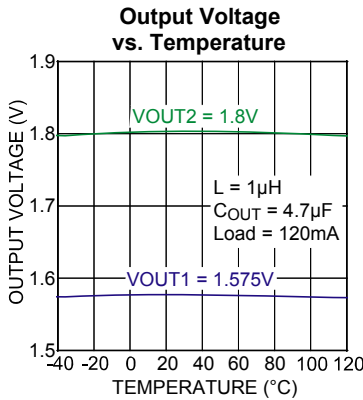
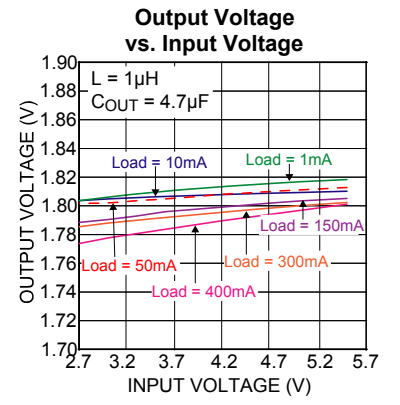
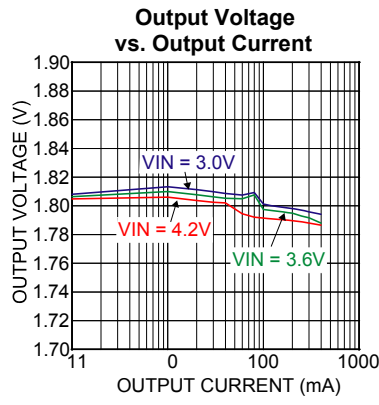
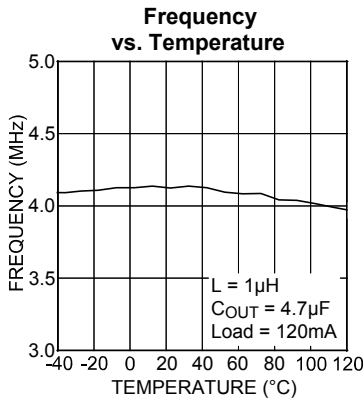
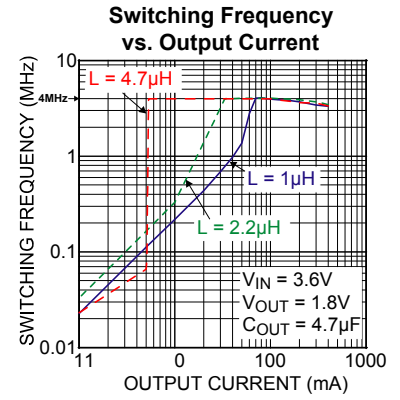
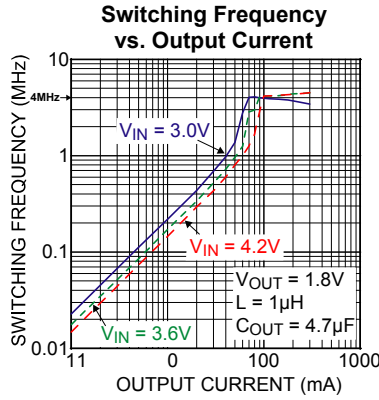
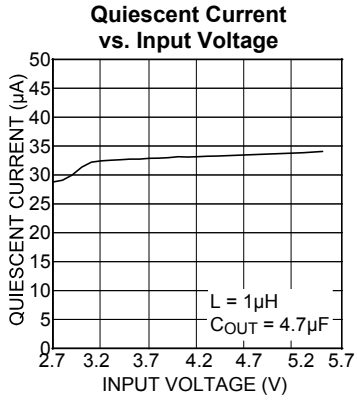

Typical Characteristics (Continued)

Efficiency $V_{OUT} = 1.8V$

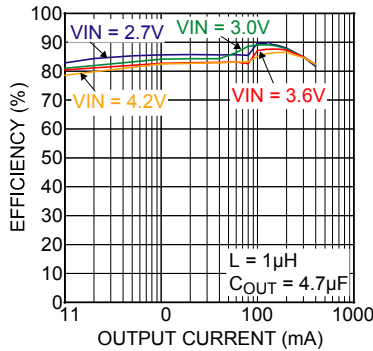

Efficiency $V_{OUT} = 2.5V$

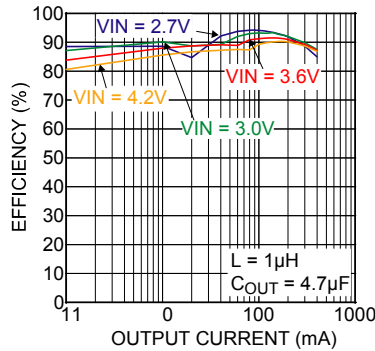

Efficiency $V_{OUT} = 3.3V$

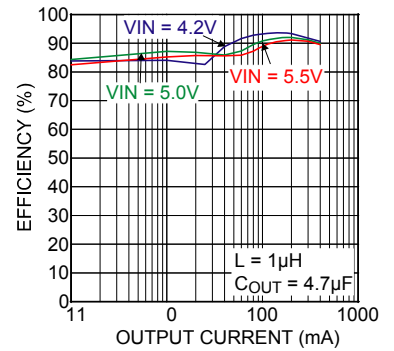

**Efficiency $V_{OUT} = 1.8V$
With Various Inductors**

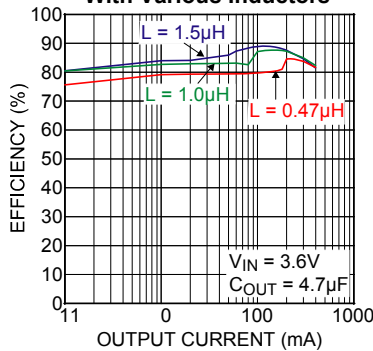

Dual Output Efficiency

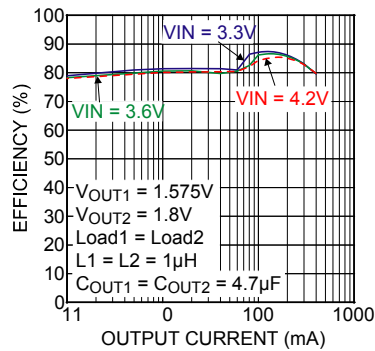

Functional Characteristics

Switching Waveform - Discontinuous Mode

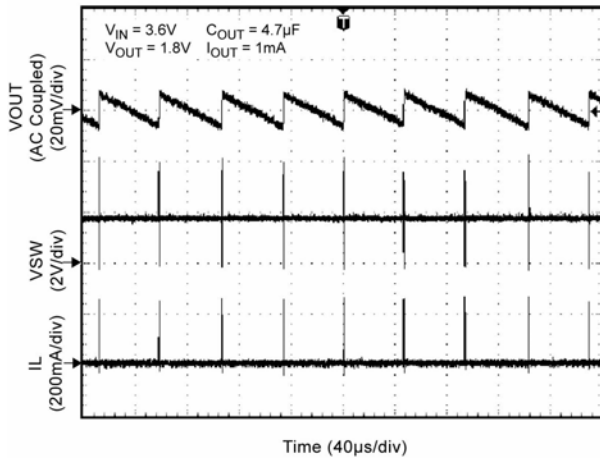

Switching Waveform - Discontinuous Mode

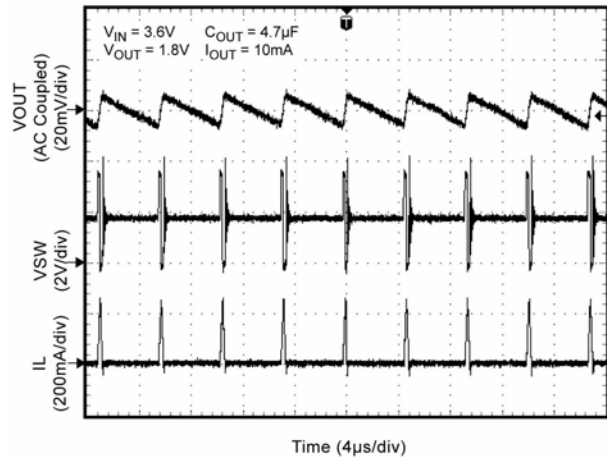

Switching Waveform - Discontinuous Mode

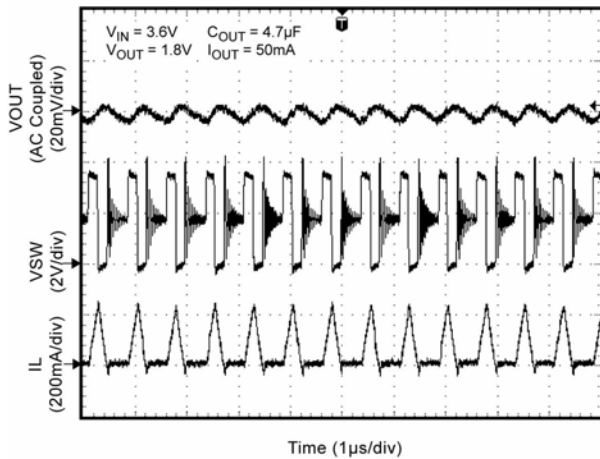

Switching Waveform - Continuous Mode

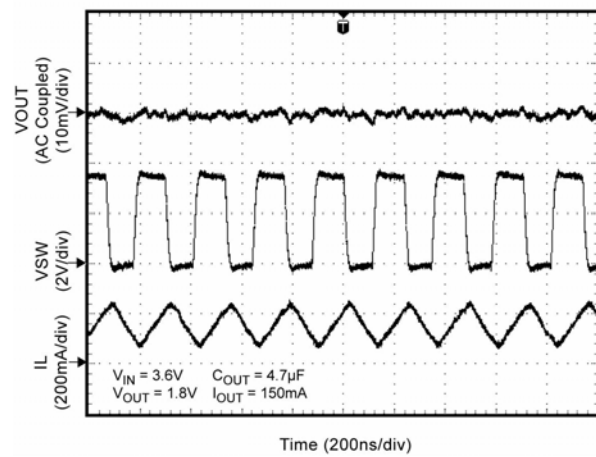

Switching Waveform - Continuous Mode

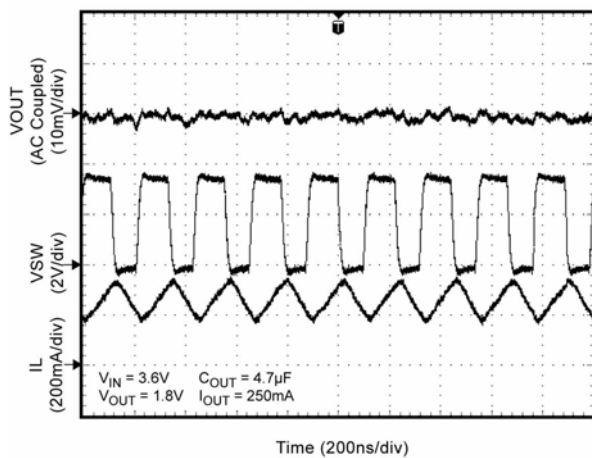

Switching Waveform - Continuous Mode

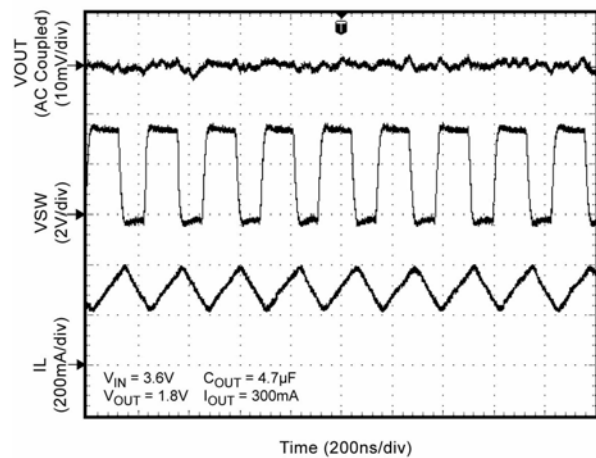

Functional Characteristics (Continued)

Start-Up Waveform

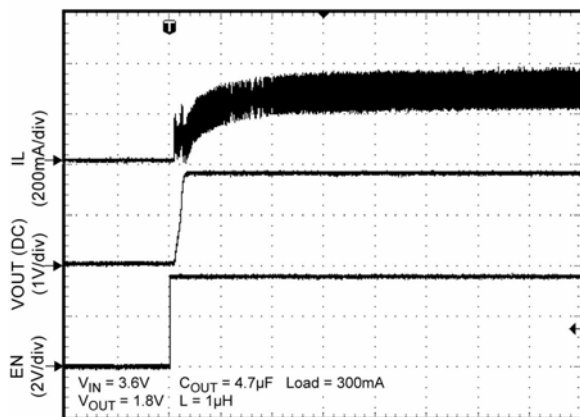

Time (1ms/div)

Start-Up Waveform

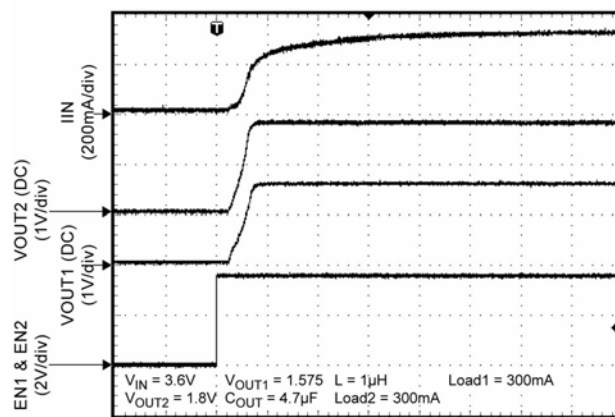

Time (400µs/div)

Load Transient

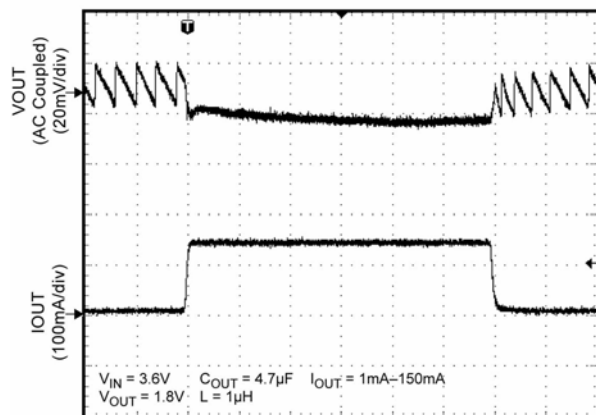

Time (20µs/div)

Load Transient

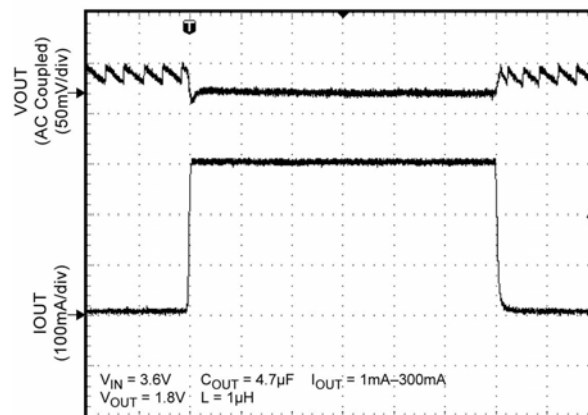

Time (20µs/div)

Load Transient

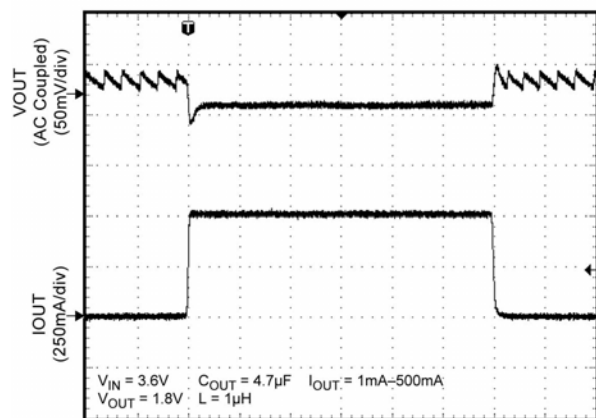

Time (20µs/div)

Load Transient

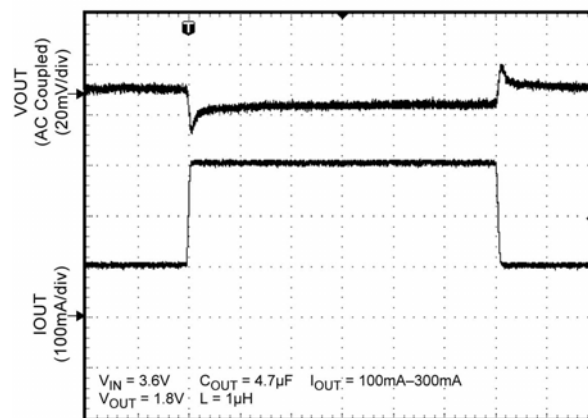

Time (20µs/div)

Functional Characteristics (Continued)

Line Transient

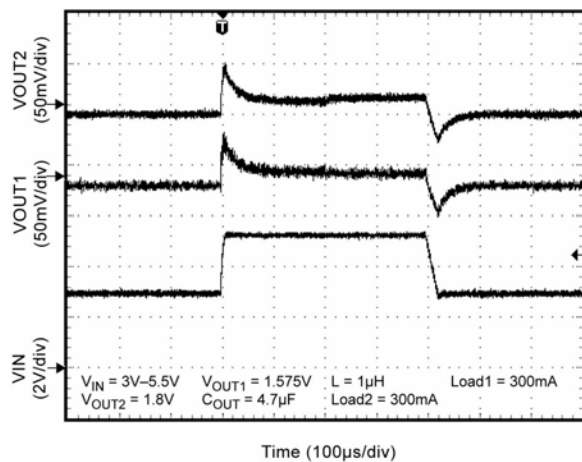

Line Transient

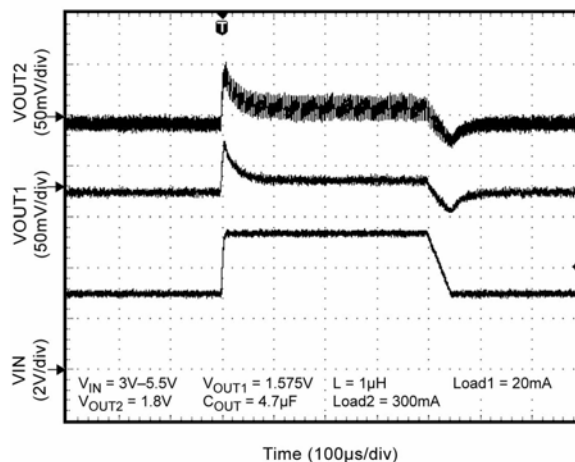

Functional Diagram

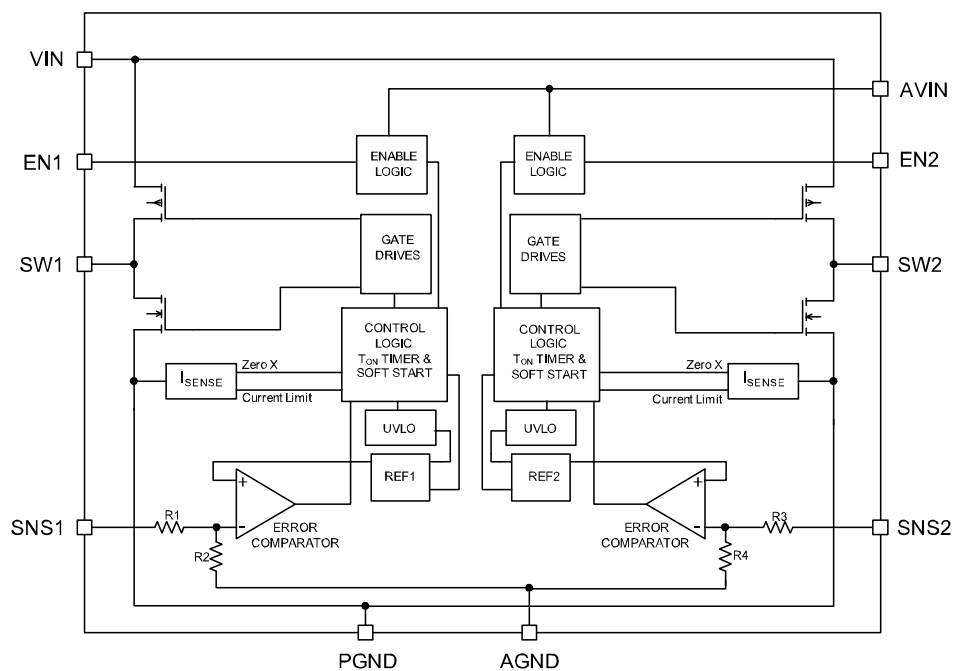

MIC23250 Simplified Fixed Output Block Diagram

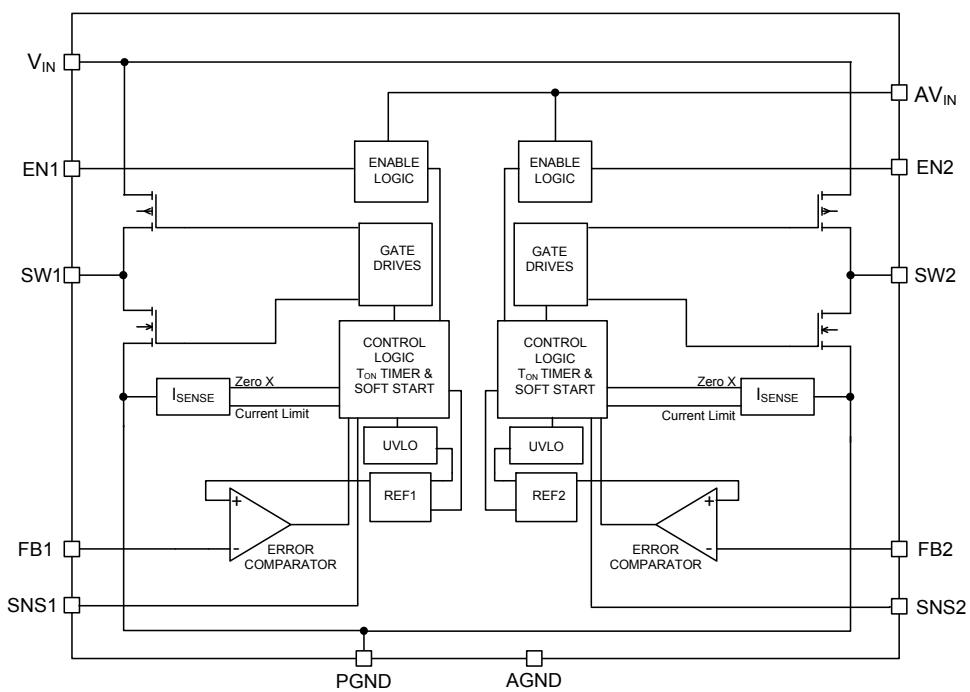

MIC23250 Simplified Adjustable Output Block Diagram

Functional Description

VIN

The VIN provides power to the internal MOSFETs for the switch mode regulator along with the current limit sensing. The VIN operating range is 2.7V to 5.5V so an input capacitor with a minimum of 6.3V voltage rating is recommended. Due to the high switching speed, a minimum of 2.2μF bypass capacitor placed close to VIN and the power ground (PGND) pin is required. Based upon size, performance and cost, a TDK C1608X5R0J475K, size 0603, 4.7μF ceramic capacitor is highly recommended for most applications. Refer to the layout recommendations for details.

AVIN

The analog VIN (AVIN) provides power to the analog supply circuitry. AVIN and VIN must be tied together. Careful layout should be considered to ensure high frequency switching noise caused by VIN is reduced before reaching AVIN. A 0.01μF bypass capacitor placed as close to AVIN as possible is recommended. See layout recommendations for details.

EN1/EN2

The enable pins (EN1 and EN2) control the on and off states of outputs 1 and 2, respectively. A logic high signal on the enable pin activates the output voltage of the device. A logic low signal on each enable pin deactivates the output. MIC23250 features built-in soft-start circuitry that reduces in-rush current and prevents the output voltage from overshooting at start up.

SW1/SW2

The switching pin (SW1 or SW2) connects directly to one end of the inductor (L1 or L2) and provides the current path during switching cycles. The other end of the inductor is connected to the load and SNS pin. Due to the high speed switching on this pin, the switch node should be routed away from sensitive nodes.

SNS1/SNS2

The SNS pin (SNS1 or SNS2) is connected to the output of the device to provide feedback to the control circuitry. A minimum of 2.2μF bypass capacitor should be connected in shunt with each output. Based upon size, performance and cost, a TDK C1608X5R0J475K, size 0603, 4.7μF ceramic capacitor is highly recommended for most applications. In order to reduce parasitic inductance, it is good practice to place the output bypass capacitor as close to the inductor as possible. The SNS connection should be placed close to the output bypass capacitor. Refer to the layout recommendations for more details.

PGND

The power ground (PGND) is the ground path for the high current in PWM mode. The current loop for the power ground should be as small as possible and separate from the Analog ground (AGND) loop. Refer to the layout recommendations for more details.

AGND

The signal ground (AGND) is the ground path for the biasing and control circuitry. The current loop for the signal ground should be separate from the Power ground (PGND) loop. Refer to the layout recommendations for more details.

FB1/FB2 (Adjustable Output Only)

The feedback pins (FB1/FB2) are two extra pins that can only be found on the MIC23250-AAYMT devices. It allows the regulated output voltage to be set by applying an external resistor network. The internal reference voltage is 0.72V and the recommended value of R_{BOTTOM} is within 10% of 442kΩ. The R_{TOP} resistor is the resistor from the FB pin to the output of the device and R_{BOTTOM} is the resistor from the FB pin to ground. The output voltage is calculated from the equation below. See Compensation under the Applications Information section for recommended feedback component values.

$$V_{OUT} = 0.72V \left(\frac{R_{TOP}}{R_{BOTTOM}} + 1 \right)$$

Applications Information

The MIC23250 is designed for high performance with a small solution size. With a dual 400mA output inside a tiny 2mm x 2mm Thin MLF[®] package and requiring only six external components, the MIC23250 meets today's miniature portable electronic device needs. While small solution size is one of its advantages, the MIC23250 is big in performance. Using the HyperLight Load™ switching scheme, the MIC23250 is able to maintain high efficiency throughout the entire load range while providing ultra-fast load transient response. Even with all the given benefits, the MIC23250 can be as easy to use as linear regulators. The following sections provide an over view of implementing MIC23250 into related applications

Input Capacitor

A minimum of 2.2μF ceramic capacitor should be placed close to the VIN pin and PGND pin for bypassing. A TDK C1608X5R0J475K, size 0603, 4.7μF ceramic capacitor is recommended based upon performance, size and cost. A X5R or X7R temperature rating is recommended for the input capacitor. Y5V temperature rating capacitors, aside from losing most of their capacitance over temperature, can also become resistive at high frequencies. This reduces their ability to filter out high frequency noise.

Output Capacitor

The MIC23250 was designed for use with a 2.2μF or greater ceramic output capacitor. Increasing the output capacitance will lower output ripple and improve load transient response but could increase solution size or cost. A low equivalent series resistance (ESR) ceramic output capacitor such as the TDK C1608X5R0J475K, size 0603, 4.7μF ceramic capacitor is recommended based upon performance, size and cost. Either the X7R or X5R temperature rating capacitors are recommended. The Y5V and Z5U temperature rating capacitors, aside from the undesirable effect of their wide variation in capacitance over temperature, become resistive at high frequencies.

Inductor Selection

Inductor selection will be determined by the following (not necessarily in the order of importance);

- Inductance
- Rated current value
- Size requirements
- DC resistance (DCR)

The MIC23250 was designed for use with an inductance range from 0.47μH to 4.7μH. Typically, a 1μH inductor is recommended for a balance of transient response, efficiency and output ripple. For faster transient response a 0.47μH inductor may be used. For lower output ripple, a 4.7μH is recommended.

Maximum current ratings of the inductor are generally given in two methods; permissible DC current and saturation current. Permissible DC current can be rated either for a 40°C temperature rise or a 10% to 20% loss in inductance. Ensure the inductor selected can handle the maximum operating current. When saturation current is specified, make sure that there is enough margin so that the peak current of the inductor does not cause it to saturate. Peak current can be calculated as follows:

$$I_{PEAK} = \left[I_{OUT} + V_{OUT} \left(\frac{1 - V_{OUT} / V_{IN}}{2 \times f \times L} \right) \right]$$

As shown by the previous calculation, the peak inductor current is inversely proportional to the switching frequency and the inductance; the lower the switching frequency or the inductance the higher the peak current. As input voltage increases the peak current also increases.

The size of the inductor depends on the requirements of the application. Refer to the Application Circuit and Bill of Material for details.

DC resistance (DCR) is also important. While DCR is inversely proportional to size, DCR can represent a significant efficiency loss. Refer to the Efficiency Considerations.

Compensation

The MIC23250 is designed to be stable with a 0.47μH to 4.7μH inductor with a minimum of 2.2μF ceramic (X5R) output capacitor. For the adjustable MIC23250, the total feedback resistance should be kept around 1MΩ to reduce current loss down the feedback resistor network. This helps to improve efficiency. A feed-forward capacitor (CFF) of 120pF must be used in conjunction with the external feedback resistors to reduce the effects of parasitic capacitance that is inherent of most circuit board layouts. Figure 1 and Table 1 shows the recommended feedback resistor values along with the recommended feed-forward capacitor values for the MIC23250 adjustable device.

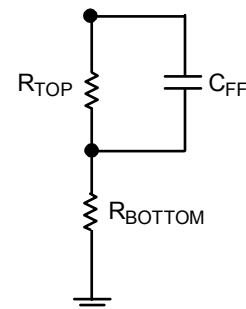

Figure 1. Feedback Resistor Network

| V _{OUT} (V) | R _{TOP} (kΩ) | R _{BOTTOM} (kΩ) | CFF (pF) |
|----------------------|-----------------------|--------------------------|----------|
| 0.8 | 49 | 442 | 120 |
| 0.9 | 111 | 442 | 120 |
| 1 | 172 | 442 | 120 |
| 1.1 | 233 | 442 | 120 |
| 1.2 | 295 | 442 | 120 |
| 1.3 | 356 | 442 | 120 |
| 1.4 | 417 | 442 | 120 |
| 1.5 | 479 | 442 | 120 |
| 1.6 | 540 | 442 | 120 |
| 1.7 | 602 | 442 | 120 |
| 1.8 | 663 | 442 | 120 |
| 1.9 | 724 | 442 | 120 |
| 2 | 786 | 442 | 120 |
| 2.1 | 847 | 442 | 120 |
| 2.2 | 909 | 442 | 120 |
| 2.3 | 970 | 442 | 120 |
| 2.4 | 1031 | 442 | 120 |
| 2.5 | 1093 | 442 | 120 |
| 2.6 | 1154 | 442 | 120 |
| 2.7 | 1216 | 442 | 120 |
| 2.8 | 1277 | 442 | 120 |
| 2.9 | 1338 | 442 | 120 |
| 3 | 1400 | 442 | 120 |
| 3.1 | 1461 | 442 | 120 |
| 3.2 | 1522 | 442 | 120 |
| 3.3 | 1584 | 442 | 120 |

Table 1. Recommended Feedback Component Values

Efficiency Considerations

Efficiency is defined as the amount of useful output power, divided by the amount of power supplied.

$$Efficiency \% = \left(\frac{V_{OUT} \times I_{OUT}}{V_{IN} \times I_{IN}} \right) \times 100$$

Maintaining high efficiency serves two purposes. It reduces power dissipation in the power supply, reducing the need for heat sinks and thermal design considerations and it reduces consumption of current for battery powered applications. Reduced current draw from a battery increases the devices operating time and is critical in hand held devices.

There are two types of losses in switching converters; DC losses and switching losses. DC losses are simply the power dissipation of I²R. Power is dissipated in the high side switch during the on cycle. Power loss is equal to the high side MOSFET R_{DS(on)} multiplied by the Switch Current squared. During the off cycle, the low side N-channel MOSFET conducts, also dissipating power. Device operating current also reduces efficiency. The product of the quiescent (operating) current and the supply voltage is another DC loss. The current required driving the gates on and off at a constant 4MHz frequency and the switching transitions make up the switching losses.

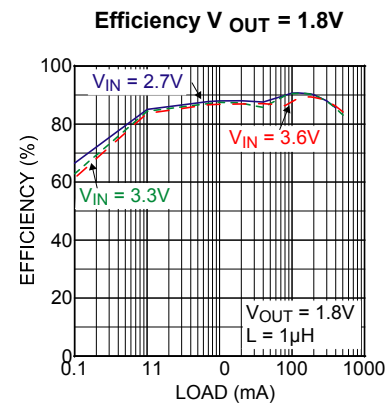

The Figure above shows an efficiency curve. From no load to 100mA, efficiency losses are dominated by quiescent current losses, gate drive and transition losses. By using the HyperLight Load™ mode the MIC23250 is able to maintain high efficiency at low output currents.

Over 100mA, efficiency loss is dominated by MOSFET R_{DS(on)} and inductor losses. Higher input supply voltages will increase the Gate-to-Source threshold on the internal MOSFETs, thereby reducing the internal R_{DS(on)}. This improves efficiency by reducing DC losses in the device. All but the inductor losses are inherent to the device. In which case, inductor selection becomes increasingly critical in efficiency calculations. As the inductors are reduced in size, the DC resistance (DCR) can become quite significant. The DCR losses can be calculated as follows:

$$DCR Loss = I_{OUT}^2 \times DCR$$

From that, the loss in efficiency due to inductor resistance can be calculated as follows:

$$Efficiency Loss = \left[1 - \left(\frac{V_{OUT} \times I_{OUT}}{V_{OUT} \times I_{OUT} + L \cdot P_D} \right) \right] \times 100$$

Efficiency loss due to DCR is minimal at light loads and gains significance as the load is increased. Inductor selection becomes a trade-off between efficiency and size in this case.

HyperLight Load Mode™

The MIC23250 uses a minimum on and off time proprietary control loop (patented by Micrel). When the output voltage falls below the regulation threshold, the error comparator begins a switching cycle that turns the PMOS on and keeps it on for the duration of the minimum-on-time. This increases the output voltage. If the output voltage is over the regulation threshold, then the error comparator turns the PMOS off for a minimum-off-time until the output drops below the threshold. The NMOS acts as an ideal rectifier that conducts when the PMOS is off. Using a NMOS switch instead of a diode allows for lower voltage drop across the switching device when it is on. The asynchronous switching combination between the PMOS and the NMOS allows the control loop to work in discontinuous mode for light load operations. In discontinuous mode, the MIC23250 works in pulse frequency modulation (PFM) to regulate the output. As the output current increases, the off-time decreases, thus providing more energy to the output. This switching scheme improves the efficiency of MIC23250 during light load currents by only switching when it is needed. As the load current increases, the MIC23250 goes into continuous conduction mode (CCM) and switches at a frequency centered at 4MHz. The equation to calculate the load when the MIC23250 goes into continuous conduction mode may be approximated by the following formula:

$$I_{LOAD} > \left(\frac{(V_{IN} - V_{OUT}) \times D}{2L \times f} \right)$$

As shown in the previous equation, the load at which MIC23250 transitions from HyperLight Load™ mode to PWM mode is a function of the input voltage (V_{IN}), output voltage (V_{OUT}), duty cycle (D), inductance (L) and frequency (f). This is illustrated in the graph below. Since the inductance range of MIC23250 is from 0.47µH to 4.7µH, the device may then be tailored to enter HyperLight Load™ mode or PWM mode at a specific load current by selecting the appropriate inductance. For example, in the graph below, when the inductance is 4.7µH the MIC23250 will transition into PWM mode at a load of approximately 5mA. Under the same condition, when the inductance is 1µH, the MIC23250 will transition into PWM mode at approximately 70mA.

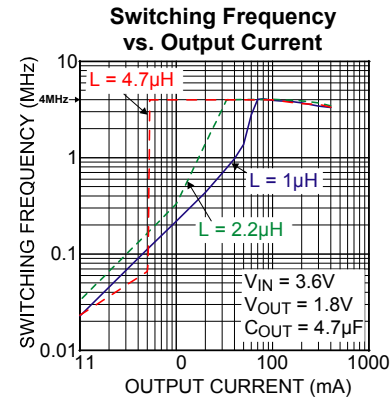

MIC23250 Typical Application Circuit (Fixed Output)

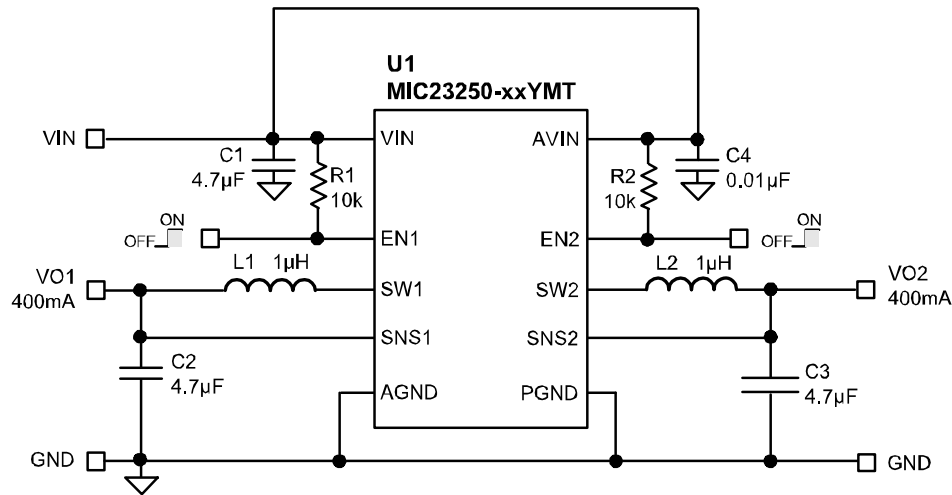

Bill of Materials

| Item | Part Number | Manufacturer | Description | Qty |
|------------|------------------|-----------------------------|--|----------|
| C1, C2, C3 | C1608X5R0J475K | TDK ⁽¹⁾ | 4.7µF Ceramic Capacitor, 6.3V, X5R, Size 0603 | 3 |
| C4 | VJ0603Y103KXXAT | Vishay ⁽²⁾ | 0.01µF Ceramic Capacitor, 25V, X7R, Size 0603 | 1 |
| R1, R2 | CRCW06031002FKEA | Vishay ⁽²⁾ | 10kΩ, 1%, 1/16W, Size 0603 | Optional |
| L1, L2 | LQM21PN1R0MC0D | Murata ⁽³⁾ | 1µH, 0.8A, 190mΩ, L2mm x W1.25mm x H0.5mm | 2 |
| | LQH32CN1R0M33 | Murata ⁽³⁾ | 1µH, 1A, 60mΩ, L3.2mm x W2.5mm x H2.0mm | |
| | LQM31PN1R0M00 | Murata ⁽³⁾ | 1µH, 1.2A, 120mΩ, L3.2mm x W1.6mm x H0.95mm | |
| | GLF251812T1R0M | TDK ⁽¹⁾ | 1µH, 0.8A, 100mΩ, L2.5mm x W1.8mm x H1.35mm | |
| | LQM31PNR47M00 | Murata ⁽³⁾ | 0.47µH, 1.4A, 80mΩ, L3.2mm x W1.6mm x H0.85mm | |
| | MIPF2520D1R5 | FDK ⁽⁴⁾ | 1.5µH, 1.5A, 70mΩ, L2.5mm x W2mm x H1.0mm | |
| | EPL2010-102 | Coilcraft ⁽⁵⁾ | 1.0µH, 1.0A, 86mΩ, L2.0mm x W1.8mm x H1.0mm | |
| U1 | MIC23250-xxYMT | Micrel, Inc. ⁽⁶⁾ | 4MHz Dual 400mA Fixed Output Buck Regulator with HyperLight Load™ Mode | 1 |

Notes:

1. TDK: www.tdk.com.
2. Vishay: www.vishay.com.
3. Murata: www.murata.com.
4. FDK: www.fdk.co.jp.
5. Coilcraft: www.coilcraft.com.
6. Micrel, Inc: www.micrel.com.

PCB Layout Recommendations (Fixed Output)

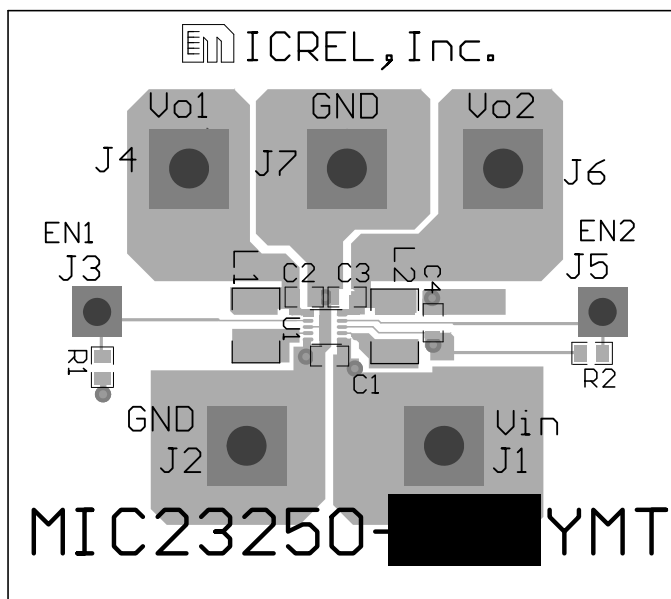

Top Layer

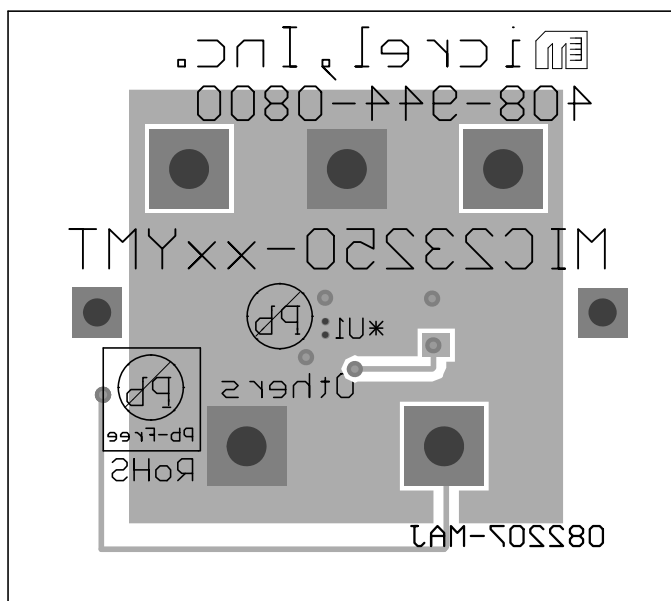

Bottom Layer

MIC23250 Typical Application Circuit (Adjustable Output)

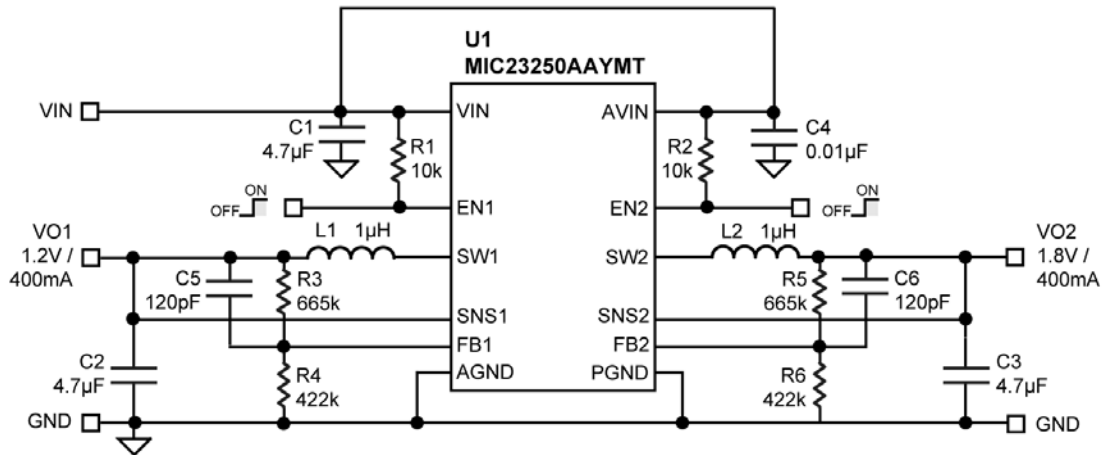

Bill of Materials

| Item | Part Number | Manufacturer | Description | Qty |
|------------|------------------|-----------------------------|---|----------|
| C1, C2, C3 | C1608X5R0J475K | TDK ⁽¹⁾ | 4.7µF Ceramic Capacitor, 6.3V, X5R, Size 0603 | 3 |
| C4 | VJ0603Y103KXXAT | Vishay ⁽²⁾ | 0.01µF Ceramic Capacitor, 25V, X7R, Size 0603 | 1 |
| C5, C6 | VJ0603Y121KXAAT | Vishay ⁽²⁾ | 120pF Ceramic Capacitor, 50V, X7R, Size 0603 | 2 |
| R1, R2 | CRCW06031002FKEA | Vishay ⁽²⁾ | 10kΩ, 1%, 1/16W, Size 0603 | Optional |
| R3, R5 | CRCW06036653FKEA | Vishay ⁽²⁾ | 665kΩ, 1%, 1/16W, Size 0603 | 2 |
| R4, R6 | CRCW06034423FKEA | Vishay ⁽²⁾ | 442kΩ, 1%, 1/16W, Size 0603 | 2 |
| L1, L2 | LQM21PN1R0MC0D | Murata ⁽³⁾ | 1µH, 0.8A, 190mΩ, L2mm x W1.25mm x H0.5mm | 2 |
| | LQH32CN1R0M33 | Murata ⁽³⁾ | 1µH, 1A, 60mΩ, L3.2mm x W2.5mm x H2.0mm | |
| | LQM31PN1R0M00 | Murata ⁽³⁾ | 1µH, 1.2A, 120mΩ, L3.2mm x W1.6mm x H0.95mm | |
| | GLF251812T1R0M | TDK ⁽¹⁾ | 1µH, 0.8A, 100mΩ, L2.5mm x W1.8mm x H1.35mm | |
| | LQM31PNR47M00 | Murata ⁽³⁾ | 0.47µH, 1.4A, 80mΩ, L3.2mm x W1.6mm x H0.85mm | |
| | MIPF2520D1R5 | FDK ⁽⁴⁾ | 1.5µH, 1.5A, 70mΩ, L2.5mm x W2mm x H1.0mm | |
| | EPL2010-102 | Coilcraft ⁽⁵⁾ | 1.0µH, 1.0A, 86mΩ, L2.0mm x W1.8mm x H1.0mm | |
| U1 | MIC23250-AAYMT | Micrel, Inc. ⁽⁶⁾ | 4MHz Dual 400mA Adjustable Output Buck Regulator with HyperLight Load™ Mode | 1 |

Notes:

1. TDK: www.tdk.com.
2. Vishay: www.vishay.com.
3. Murata: www.murata.com.
4. FDK: www.fdk.co.jp.
5. Coilcraft: www.coilcraft.com.
6. Micrel, Inc: www.micrel.com.

PCB Layout Recommendations (Adjustable Output)

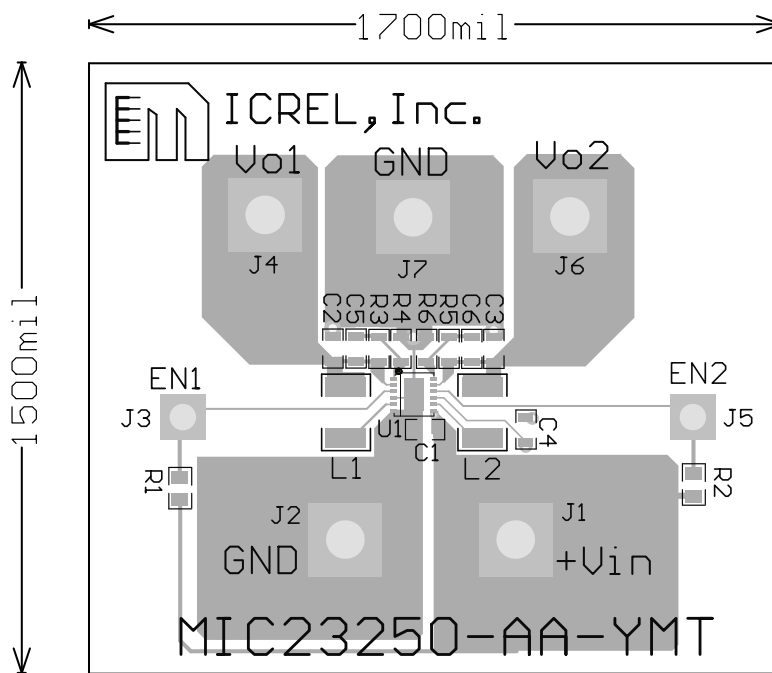

Top Layer

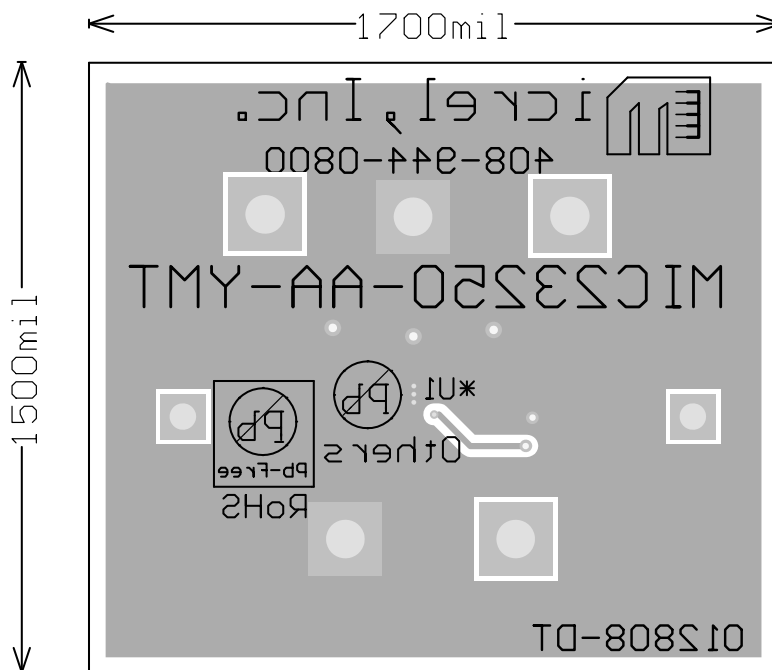

Bottom Layer

Package Information (Fixed Output)

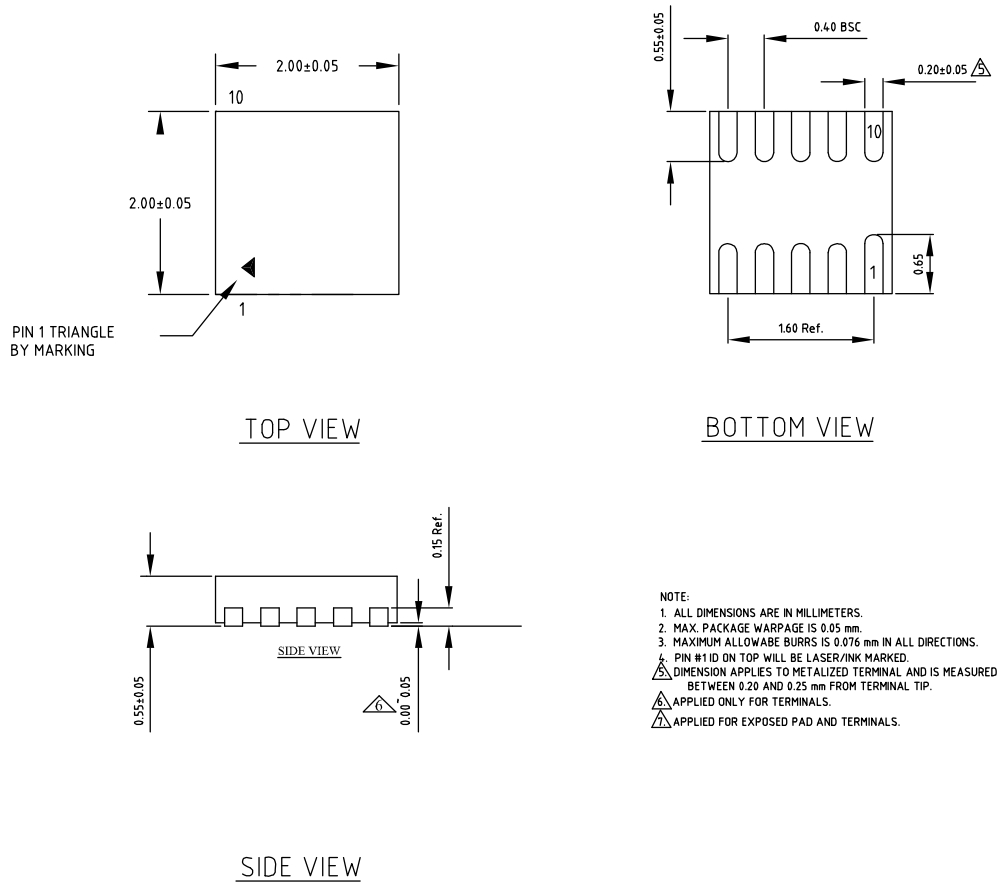

10-Pin 2mm x 2mm Thin MLF[®] (MT)

Package Information (Adjustable Output)

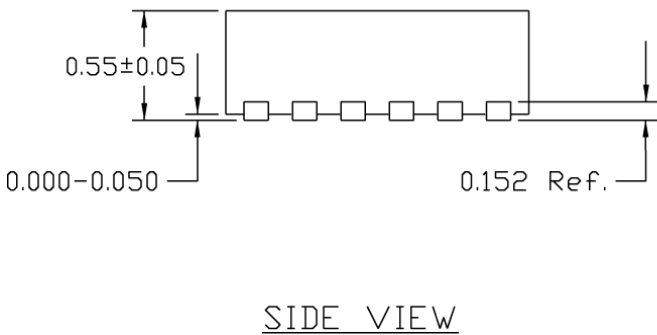
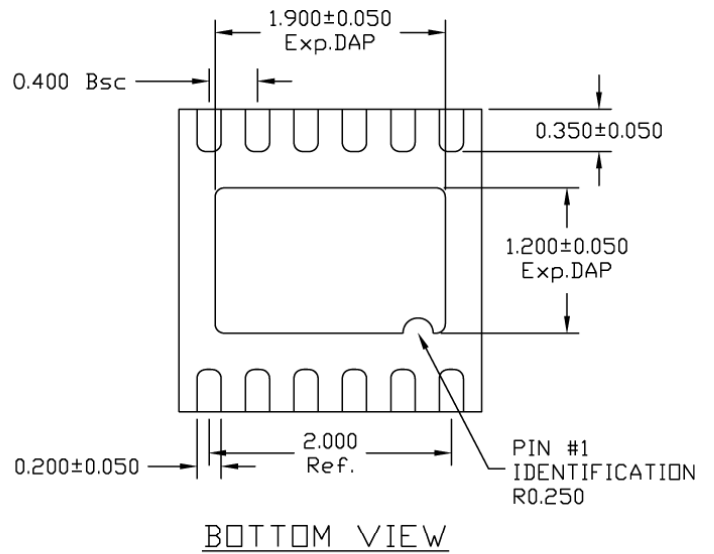
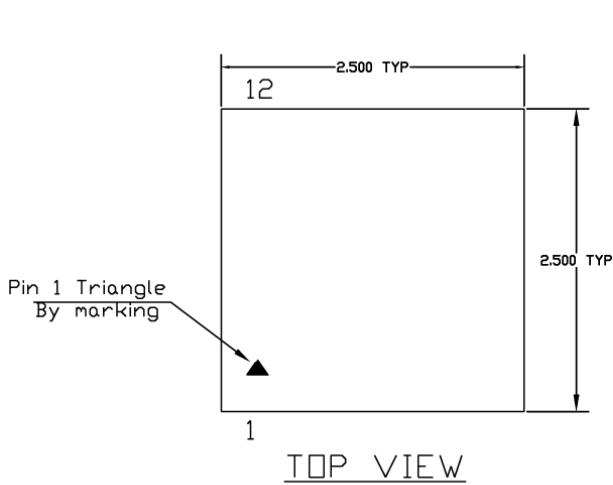

NOTES :

1. ALL DIMENSIONS ARE IN MILLIMETERS.
2. MAX. PACKAGE WARPAGE IS 0.05 mm.
3. MAXIMUM ALLOWABLE BURRS IS 0.076 mm IN ALL DIRECTIONS.
4. PIN #1 ID ON TOP WILL BE LASER MARKED.

12-Pin 2.5mm x 2.5mm Thin MLF® (MT)

MICREL, INC. 2180 FORTUNE DRIVE SAN JOSE, CA 95131 USA
 TEL +1 (408) 944-0800 FAX +1 (408) 474-1000 WEB <http://www.micrel.com>

The information furnished by Micrel in this data sheet is believed to be accurate and reliable. However, no responsibility is assumed by Micrel for its use. Micrel reserves the right to change circuitry and specifications at any time without notification to the customer.

Micrel Products are not designed or authorized for use as components in life support appliances, devices or systems where malfunction of a product can reasonably be expected to result in personal injury. Life support devices or systems are devices or systems that (a) are intended for surgical implant into the body or (b) support or sustain life, and whose failure to perform can be reasonably expected to result in a significant injury to the user. A Purchaser's use or sale of Micrel Products for use in life support appliances, devices or systems is a Purchaser's own risk and Purchaser agrees to fully indemnify Micrel for any damages resulting from such use or sale.

© 2007 Micrel, Incorporated.