

### Data Sheet

#### Description

The oval shaped radiation pattern and high luminous intensity ensure that these devices are excellent for wide field of view outdoor applications where a wide viewing angle and readability in sunlight are essential. The package epoxy contains both UV inhibitors to reduce the effects of long-term exposure to direct sunlight.

#### Applications

- Mono color signs

#### Features

- Well-defined spatial radiation patterns
- High brightness material
- Available in green and blue color
  - Green InGaN 525 nm
  - Blue InGaN 470 nm
- Superior resistance to moisture
- Standoff and non stand-off package
- Tinted and diffused
- Typical viewing angle 40° x 100°

**CAUTION** InGaN devices are Class 1C HBM ESD sensitive per JEDEC Standard. Observe appropriate precautions during handling and processing. Refer to Application Note AN-1142 for additional details.

#### Package Dimensions

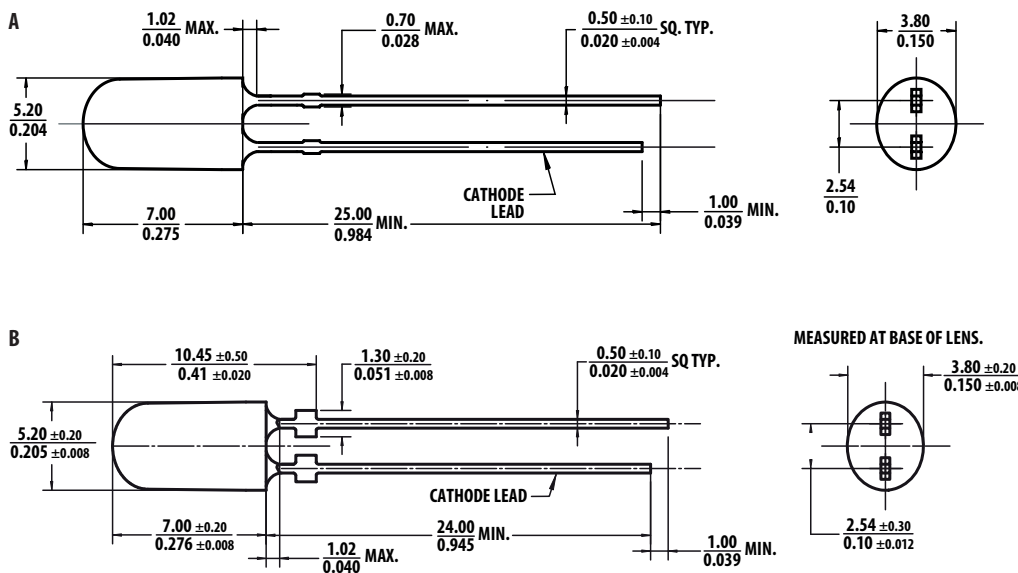

Notes:  
All dimensions in millimeters (inches).  
Tolerance is ± 0.20 mm unless otherwise specified.

## Device Selection Guide

Part Number	Color and Dominant Wavelength $\lambda_d$ (nm), Typ <sup>a</sup>	Luminous Intensity Iv (mcd) at 20 mA <sup>b,c,d</sup>		Standoff	Package Drawing
		Min	Max		
HLMP-HB70-TVBD	Blue 470	800	1380	No	A
HLMP-HB70-TVCD	Blue 470	800	1380	No	A
HLMP-HB71-TVBD	Blue 470	800	1380	Yes	B
HLMP-HB71-TVCD	Blue 470	800	1380	Yes	B
HLMP-HM70-23BD	Green 525	3500	5040	No	A
HLMP-HM70-23CD	Green 525	3500	5040	No	A
HLMP-HM71-23BD	Green 525	3500	5040	Yes	B
HLMP-HM71-23CD	Green 525	3500	5040	Yes	B

- The dominant wavelength,  $\lambda_d$ , is derived from the CIE Chromaticity Diagram and represents the color of the lamp.
- The luminous intensity is measured on the mechanical axis of the lamp package, and it is tested with pulsing condition.
- The optical axis is closely aligned with the package mechanical axis.
- Tolerance for each intensity bin limit is  $\pm 15\%$ .

## Part Numbering System

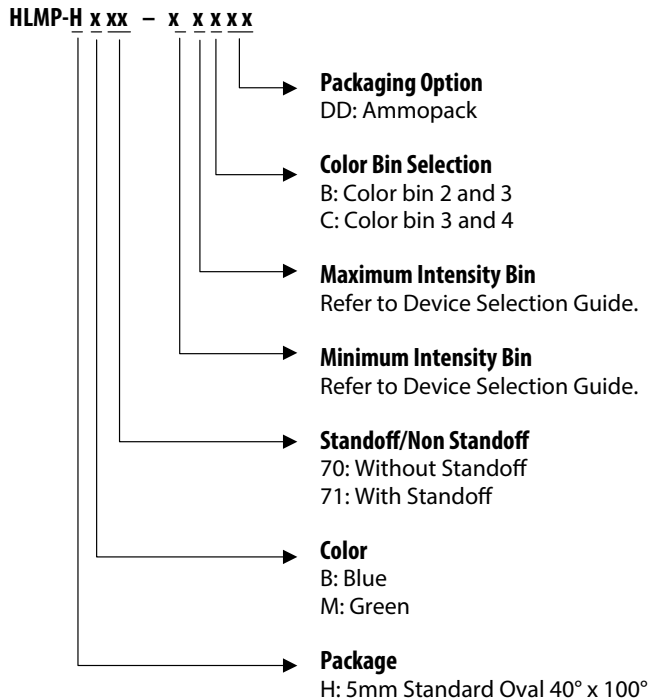

Note: Refer to AB 5337 for complete information on the part numbering system.

## Absolute Maximum Ratings

$T_A = 25\text{ }^\circ\text{C}$

Parameter	Blue and Green	Unit
DC Forward Current <sup>a</sup>	30	mA
Peak Forward Current	100 <sup>b</sup>	mA
Power Dissipation	110	mW
LED Junction Temperature	110	$^\circ\text{C}$
Operating Temperature Range	-40 to +85	$^\circ\text{C}$
Storage Temperature Range	-40 to +100	$^\circ\text{C}$

- Derate linearly as shown in [Figure 4](#).
- Duty Factor 10%, frequency 1 KHz.

## Electrical/Optical Characteristics

$T_A = 25\text{ }^\circ\text{C}$

Parameter	Symbol	Min	Typ	Max	Unit	Test Conditions
Forward Voltage Green and Blue	$V_F$	2.8	3.1	3.6	V	$I_F = 20\text{ mA}$
Reverse Voltage <sup>a</sup> Green and Blue	$V_R$	5			V	$I_R = 10\text{ }\mu\text{A}$
Dominant Wavelength <sup>b</sup> Green Blue	$\lambda_d$	520 460	525 470	540 480	nm nm	$I_F = 20\text{ mA}$
Peak Wavelength Green Blue	$\lambda_{PEAK}$		517 461		nm nm	Peak of Wavelength of Spectral Distribution at $I_F = 20\text{ mA}$
Thermal Resistance	$R\theta_{J-PIN}$		240		$^\circ\text{C/W}$	LED Junction-to-Cathode Lead
Luminous Efficacy <sup>c</sup> Green Blue	$\eta_V$		475 68		lm/W	Emitted Luminous Flux/Electrical Power

- Indicates product final testing condition; long-term reverse bias is not recommended.
- The dominant wavelength is derived from the chromaticity diagram and represents the color of the lamp.
- The radiant intensity,  $I_e$ , in watts per steradian, may be found from the equation  $I_e = I_v/\eta_V$ , where  $I_v$  is the luminous intensity in candelas and  $\eta_V$  is the luminous efficacy in lumens/watt.

## InGaN Blue and Green

Figure 1 Relative Intensity vs. Wavelength

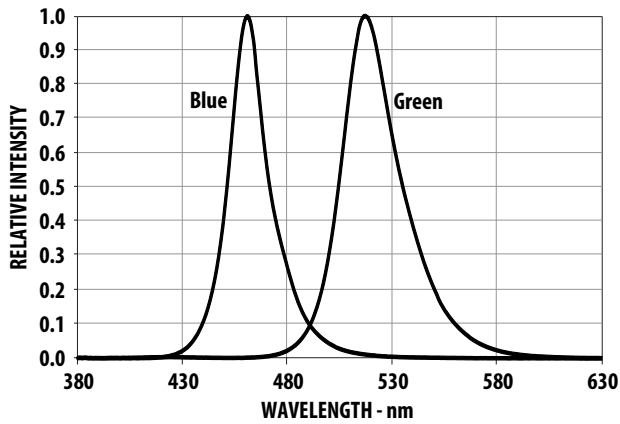

Figure 2 Forward Current vs. Forward Voltage

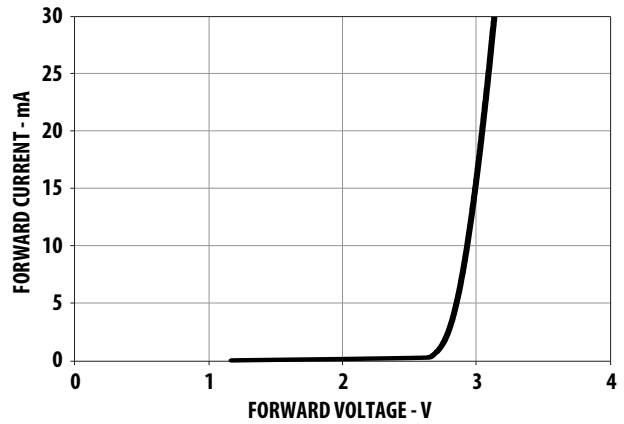

Figure 3 Relative Intensity vs. Forward Current

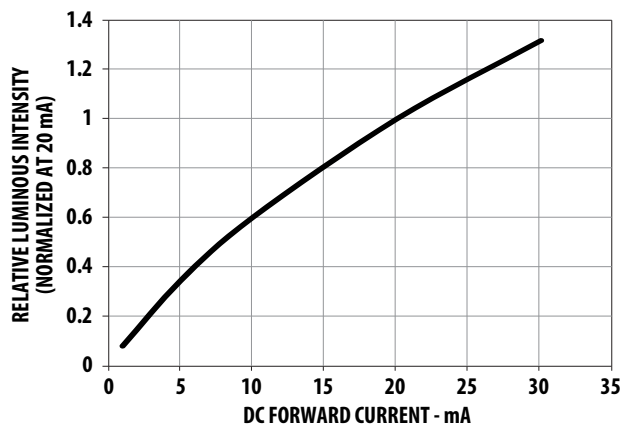

Figure 4 Maximum Forward Current vs. Ambient Temperature

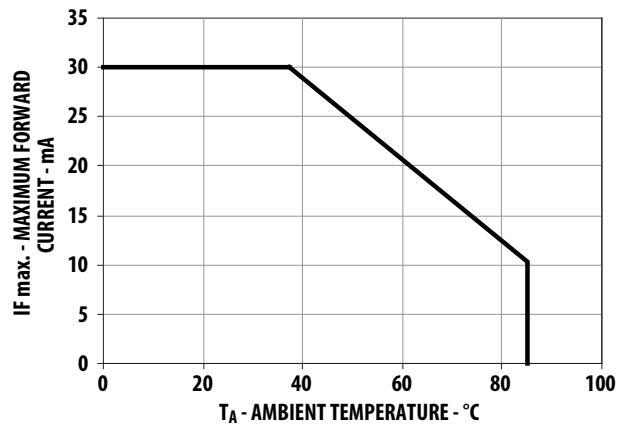

Figure 5 Relative Dominant Wavelength vs. Forward Current

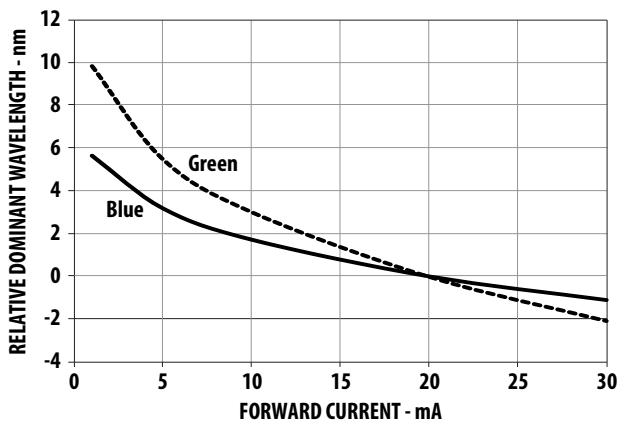

Figure 6 Radiation Pattern, Major Axis

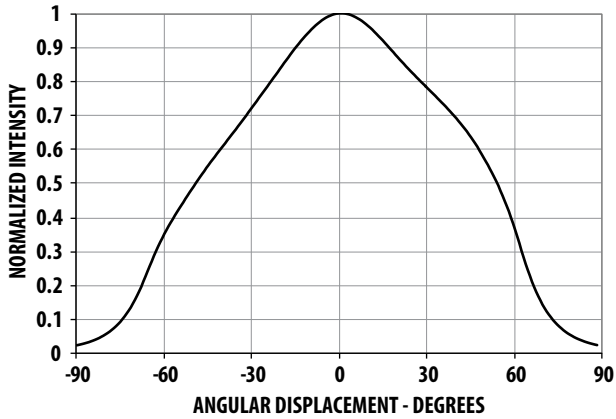

Figure 7 Radiation Pattern, Minor Axis

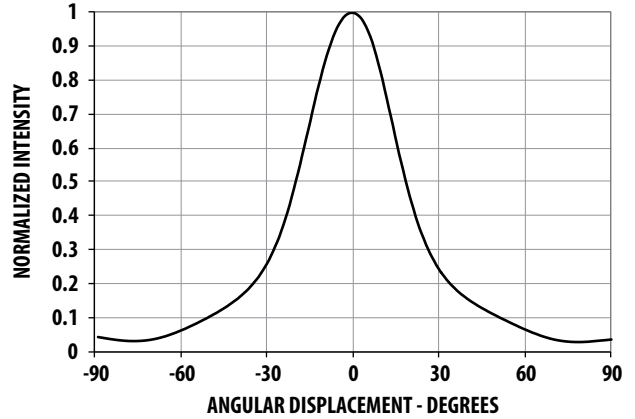

Figure 8 Relative Light Output vs Junction Temperature

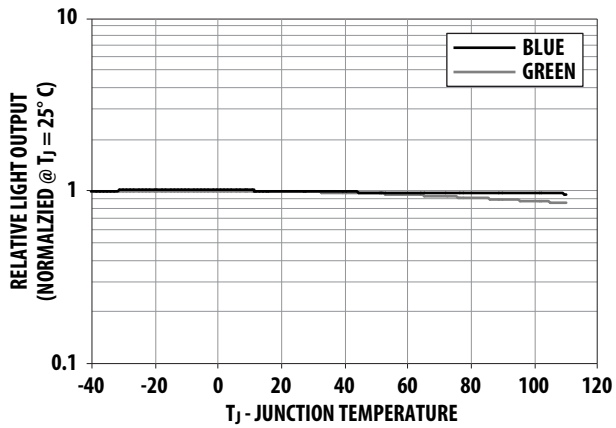
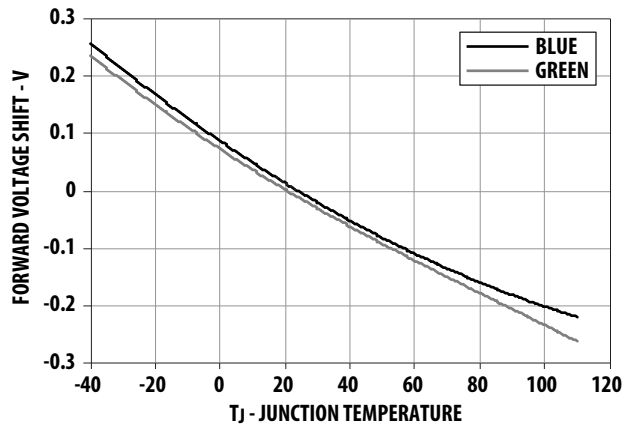

Figure 9 Forward Voltage Shift vs Junction Temperature



## Intensity Bin Limits (1.2: 1 Iv Bin Ratio)

Bin <sup>a</sup>	Intensity (mcd) at 20 mA		Bin <sup>a</sup>	Intensity (mcd) at 20 mA	
	Min	Max		Min	Max
T	800	960	Y	1990	2400
U	960	1150	Z	2400	2900
V	1150	1380	1	2900	3500
W	1380	1660	2	3500	4200
X	1660	1990	3	4200	5040

a. Tolerance for each bin limit is  $\pm 15\%$ .

## Green Color Bin Table

Bin <sup>a</sup>	Min Dom	Max Dom	Xmin	Ymin	Xmax	Ymax
1	520.0	524.0	0.0743	0.8338	0.1856	0.6556
			0.1650	0.6586	0.1060	0.8292
2	524.0	528.0	0.1060	0.8292	0.2068	0.6463
			0.1856	0.6556	0.1387	0.8148
3	528.0	532.0	0.1387	0.8148	0.2273	0.6344
			0.2068	0.6463	0.1702	0.7965
4	532.0	536.0	0.1702	0.7965	0.2469	0.6213
			0.2273	0.6344	0.2003	0.7764
5	536.0	540.0	0.2003	0.7764	0.2659	0.6070
			0.2469	0.6213	0.2296	0.7543

a. Tolerance for each bin limit is  $\pm 0.5$  nm.

## Blue Color Bin Table

Bin <sup>a</sup>	Min Dom	Max Dom	Xmin	Ymin	Xmax	Ymax
1	460.0	464.0	0.1440	0.0297	0.1766	0.0966
			0.1818	0.0904	0.1374	0.0374
2	464.0	468.0	0.1374	0.0374	0.1699	0.1062
			0.1766	0.0966	0.1291	0.0495
3	468.0	472.0	0.1291	0.0495	0.1616	0.1209
			0.1699	0.1062	0.1187	0.0671
4	472.0	476.0	0.1187	0.0671	0.1517	0.1423
			0.1616	0.1209	0.1063	0.0945
5	476.0	480.0	0.1063	0.0945	0.1397	0.1728
			0.1517	0.1423	0.0913	0.1327

a. Tolerance for each bin limit is  $\pm 0.5$  nm.

Note: All bin categories are established for classification of products. Products may not be available in all bin categories. Please contact your Avago representative for further information.

## Precautions

### Lead Forming

- The leads of an LED lamp may be preformed or cut to length prior to insertion and soldering on PC board.
- For better control, it is recommended to use the proper tool to precisely form and cut the leads to the applicable length rather than doing it manually.
- If manual lead cutting is necessary, cut the leads after the soldering process. The solder connection forms a mechanical ground that prevents mechanical stress due to lead cutting from traveling into LED package. This is highly recommended for hand soldering operation, as the excess lead length also acts as small heat sink.

### Soldering and Handling

- Take care during PCB assembly and soldering process to prevent damage to the LED component.
- LED component may be effectively hand soldered to PCB. However, it is recommended only under unavoidable circumstances, such as rework. The closest manual soldering distance of the soldering heat source (soldering iron's tip) to the body is 1.59 mm. Soldering the LED using soldering iron tip closer than 1.59 mm might damage the LED.

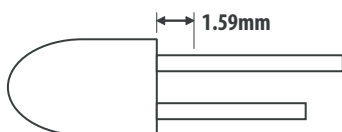

- ESD precautions must be properly applied on the soldering station and personnel to prevent ESD damage to the LED component that is ESD sensitive. Refer to Avago application note AN 1142 for details. The soldering iron used should have a grounded tip to ensure electrostatic charge is properly grounded.
- Recommended soldering condition:

	Wave Soldering <sup>a,b</sup>	Manual Solder Dipping
Pre-heat temperature	105 °C Max.	—
Preheat time	60 sec Max	—
Peak temperature	260 °C Max.	260 °C Max.
Dwell time	5 sec Max.	5 sec Max

- Above conditions refer to measurement with thermocouple mounted at the bottom of PCB.
- It is recommended to use only bottom preheaters in order to reduce thermal stress experienced by LED.

- Wave soldering parameters must be set and maintained according to the recommended temperature and dwell time. The customer is advised to perform daily checks on the soldering profile to ensure that it is always conforming to recommended soldering conditions.

**NOTE** PCBs with different size and design (component density) will have different heat mass (heat capacity). This might cause a change in temperature experienced by the board if the same wave soldering setting is used. So, it is recommended to recalibrate the soldering profile again before loading a new type of PCB.

## Avago Technologies LED Configuration

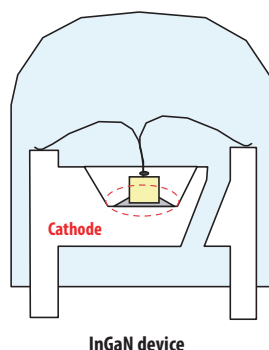

- Any alignment fixture that is being applied during wave soldering should be loosely fitted and should not apply weight or force on LED. Nonmetal material is recommended as it will absorb less heat during wave soldering process.
- At elevated temperature, LED is more susceptible to mechanical stress. Therefore, the PCB must allowed to cool down to room temperature prior to handling, which includes removal of alignment fixture or pallet.
- If the PCB board contains both through hole (TH) LED and other surface mount components, it is recommended that surface mount components be soldered on the top side of the PCB. If the surface mount must be on the bottom side, these components should be soldered using reflow soldering prior to insertion the TH LED.

- The following table shows the recommended PC board plated through holes (PTH) size for LED component leads.

LED Component Lead Size	Diagonal	Plated Through Hole Diameter
0.45 x 0.45 mm (0.018 x 0.018 inch)	0.636 mm (0.025 in.)	0.98 to 1.08 mm (0.039 to 0.043 in.)
0.50 x 0.50 mm (0.020 x 0.020 inch)	0.707 mm (0.028 in.)	1.05 to 1.15 mm (0.041 to 0.045 in.)

- Over-sizing the PTH can lead to a twisted LED after clinching. On the other hand, under-sizing the PTH can cause difficulty when inserting the TH LED.

**NOTE** Refer to application note AN5334 for more information about soldering and handling of high brightness TH LED lamps.

## Application Precautions

- The drive current of the LED must not exceed the maximum allowable limit across temperature as stated in the data sheet. Constant current driving is recommended to ensure consistent performance.
- LEDs do exhibit slightly different characteristics at different drive currents that might result in larger performance variations (such as intensity, wavelength, and forward voltage). The user is recommended to set the application current as close as possible to the test current to minimize these variations.
- The LED is not intended for reverse bias. Use other appropriate components for such purposes. When driving the LED in matrix form, it is crucial to ensure that the reverse bias voltage does not exceed the allowable limit of the LED.

## Example of Wave Soldering Temperature Profile for TH LED

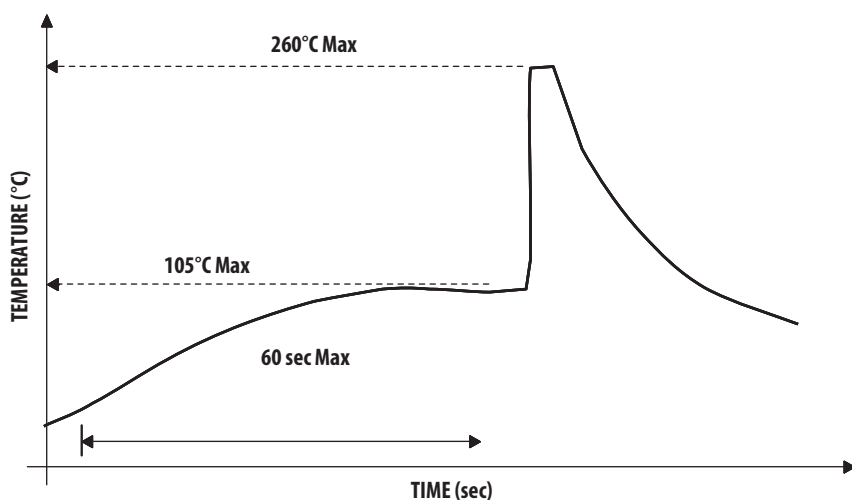

Recommended solder:  
Sn63 (Leaded solder alloy)  
SAC305 (Lead free solder alloy)

Flux: Rosin flux

Solder bath temperature: 255°C ± 5°C  
(maximum peak temperature = 260°C)

Dwell time: 3.0 sec - 5.0 sec  
(maximum = 5sec)

Note: Allow for board to be sufficiently cooled to room temperature before exerting mechanical force.



## Ammo Packs Drawing

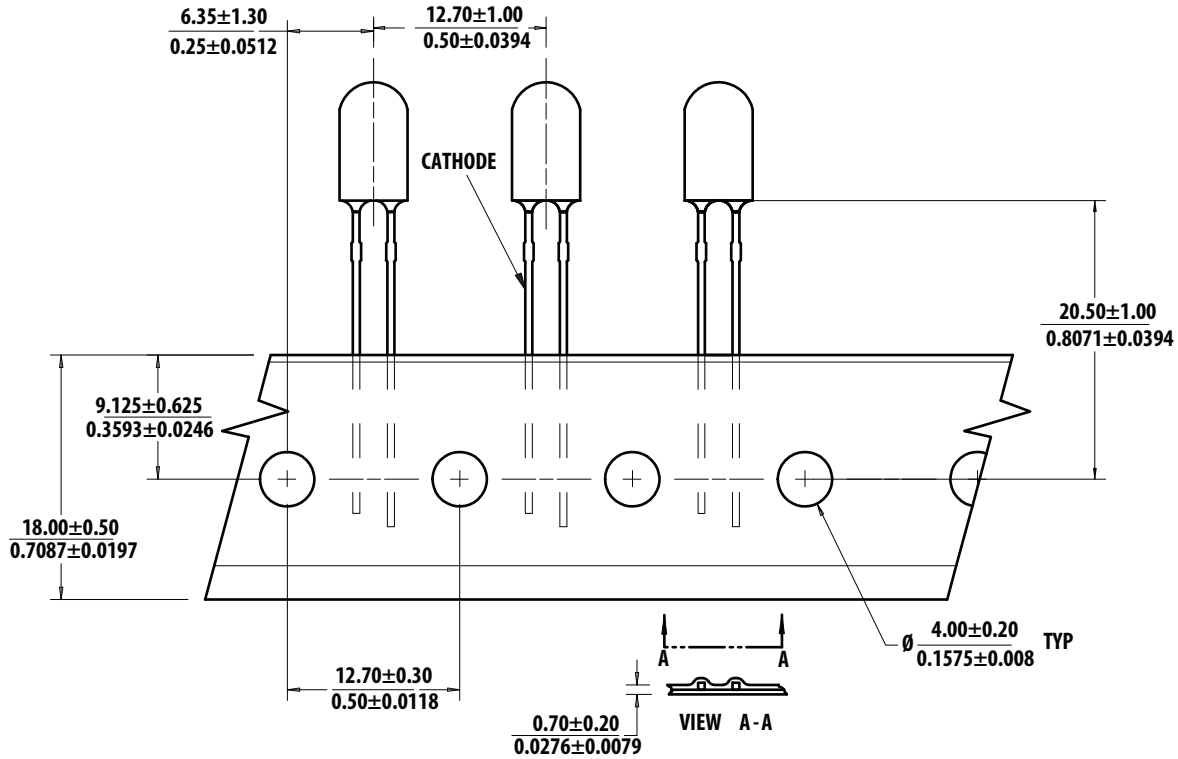

## Packaging Box for Ammo Packs

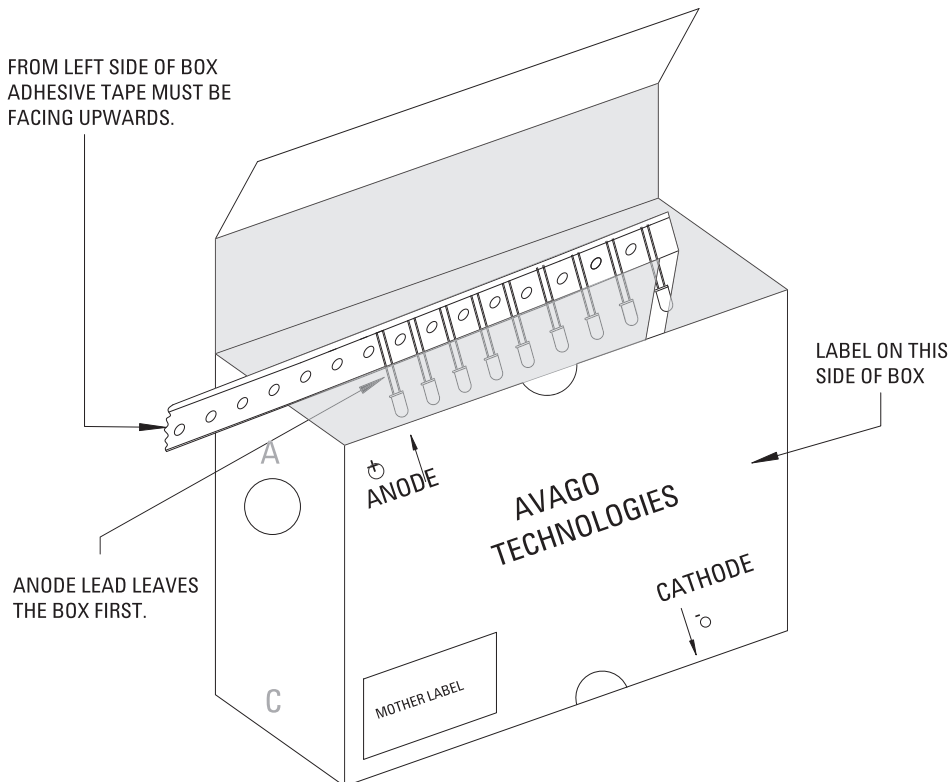











## Packaging Labels

### (i) Avago Mother Label: (Available on packaging box of ammo pack and shipping box)

	
(1P) Item: Part Number 	STANDARD LABEL LS0002 RoHS Compliant e3 max temp 260C
(1T) Lot: Lot Number 	(Q) QTY: Quantity 
LPN: 	CAT: Intensity Bin 
(9D)MFG Date: Manufacturing Date 	BIN: Refer to below information
<hr/>	
(P) Customer Item: 	
(V) Vendor ID: 	(9D) Date Code: Date Code 
<hr/>	
DeptID: 	Made In: Country of Origin 

### (ii) Avago Baby Label (Only available on bulk packaging)

	
Lamps Baby Label	
RoHS Compliant e3 max temp 260C	
(1P) PART #: Part Number 	
(1T) LOT #: Lot Number 	
(9D)MFG DATE: Manufacturing Date 	QUANTITY: Packing Quantity 
C/O: Country of Origin	
<hr/>	
Customer P/N: 	CAT: Intensity Bin 
Supplier Code: 	BIN: Refer to below information 
	DATECODE: Date Code 

## Acronyms and Definitions

BIN:

- (i) Color bin only or VF bin only
  - Applicable for part number with color bins but without VF bin OR part number with VF bins and no color bin

OR

- (ii) Color bin incorporated with VF Bin
  - Applicable for part number that have both color bin and VF bin

Example:

- (i) Color bin only or VF bin only
  - BIN: 2 (represent color bin 2 only)
  - BIN: VB (represent VF bin "VB" only)
- (ii) Color bin incorporate with VF Bin
  - BIN: 2VB, where:
    - 2 is color bin 2 only
    - VB is VF bin "VB"

**DISCLAIMER:** AVAGO'S PRODUCTS AND SOFTWARE ARE NOT SPECIFICALLY DESIGNED, MANUFACTURED OR AUTHORIZED FOR SALE AS PARTS, COMPONENTS OR ASSEMBLIES FOR THE PLANNING, CONSTRUCTION, MAINTENANCE OR DIRECT OPERATION OF A NUCLEAR FACILITY OR FOR USE IN MEDICAL DEVICES OR APPLICATIONS. CUSTOMER IS SOLELY RESPONSIBLE, AND WAIVES ALL RIGHTS TO MAKE CLAIMS AGAINST AVAGO OR ITS SUPPLIERS, FOR ALL LOSS, DAMAGE, EXPENSE OR LIABILITY IN CONNECTION WITH SUCH USE.

For product information and a complete list of distributors, please go to our web site:

[www.avagotech.com](http://www.avagotech.com)

Avago Technologies and the A logo are trademarks of Avago Technologies in the United States and other countries. All other brand and product names may be trademarks of their respective companies.

Data subject to change. Copyright © 2005-2016 Avago Technologies. All Rights Reserved.

AV02-3730EN – July 13, 2016

**AVAGO**  
TECHNOLOGIES



Lead (Pb) Free  
RoHS 6 fully  
compliant