

SWITCHING APPLICATION.
INTERFACE CIRCUIT AND DRIVER CIRCUIT APPLICATION.

FEATURES

- With Built-in Bias Resistors.
- Simplify Circuit Design.
- Reduce a Quantity of Parts and Manufacturing Process.
- Thin Fine Pitch Small Package.

EQUIVALENT CIRCUIT

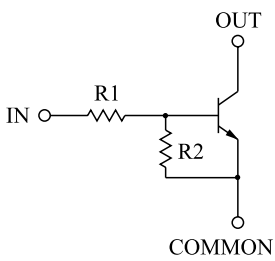

BIAS RESISTOR VALUES

TYPE NO.	R1(k)	R2(k)
KRC157F	10	47
KRC158F	22	47
KRC159F	47	22

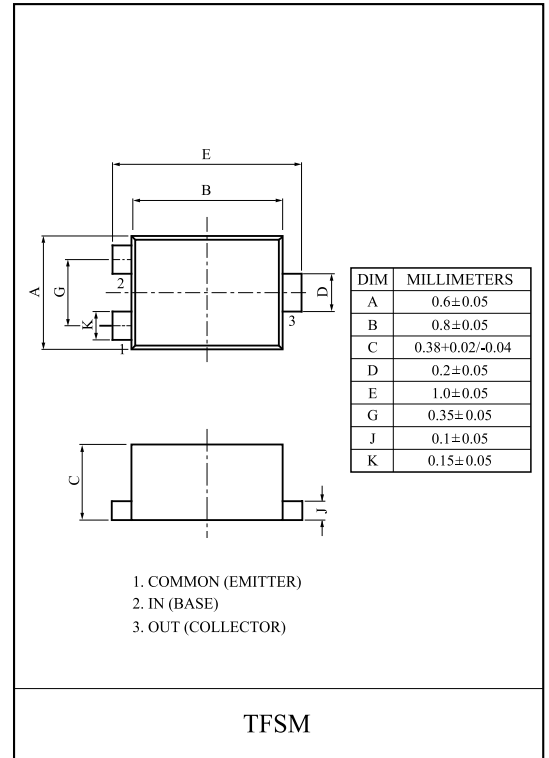

MAXIMUM RATING (Ta=25)

CHARACTERISTIC		SYMBOL	RATING	UNIT
Output Voltage	KRC157F~159F	V_O	20	V
Input Voltage	KRC157F	V_I	10/-6	V
	KRC158F		10/-7	
	KRC159F		10/-15	
Output Current	KRC157F~159F	I_O	50	mA
Power Dissipation		P_D	50	mW
Junction Temperature		T_j	150	
Storage Temperature Range		T_{stg}	-55 150	

MARK SPEC

TYPE	KRC157F	KRC158F	KRC159F
MARK	FG	FH	FI

Marking

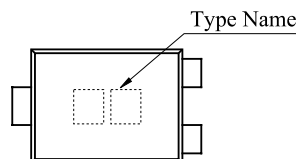

KRC157F~KRC159F

ELECTRICAL CHARACTERISTICS (Ta=25)

CHARACTERISTIC		SYMBOL	TEST CONDITION	MIN.	TYP.	MAX.	UNIT
Output Cut-off Current	KRC157F~159F	$I_{O(OFF)}$	$V_O=20V, V_I=0$	-	-	500	nA
DC Current Gain	KRC157F	G_I	$V_O=5V, I_O=10mA$	120	-	-	
	KRC158F			120	-	-	
	KRC159F			100	-	-	
Output Voltage	KRC157F~159F	$V_{O(ON)}$	$I_O=5mA, I_I=0.25mA$	-	-	0.15	V
Input Voltage (ON)	KRC157F	$V_{I(ON)}$	$V_O=0.2V, I_O=5mA$	-	-	1.5	V
	KRC158F			-	-	2.2	
	KRC159F			-	-	5.0	
Input Voltage (OFF)	KRC157F	$V_{I(OFF)}$	$V_O=5V, I_O=0.1mA$	0.5	-	-	V
	KRC158F			0.6	-	-	
	KRC159F			1.3	-	-	
Input Current	KRC157F	I_I	$V_I=5V$	-	-	0.88	mA
	KRC158F			-	-	0.36	
	KRC159F			-	-	0.16	
Input Resistor	KRC157F	R1	-	7	10	13	k
	KRC158F			15.4	22	28.6	
	KRC159F			32.9	47	61.1	
Resistor Ratio	KRC157F	R2/R1	-	3.7	4.7	5.7	
	KRC158F			1.7	2.1	26	
	KRC159F			0.37	0.47	0.57	

KRC157F~KRC159F

$I_O - V_{I(ON)}$

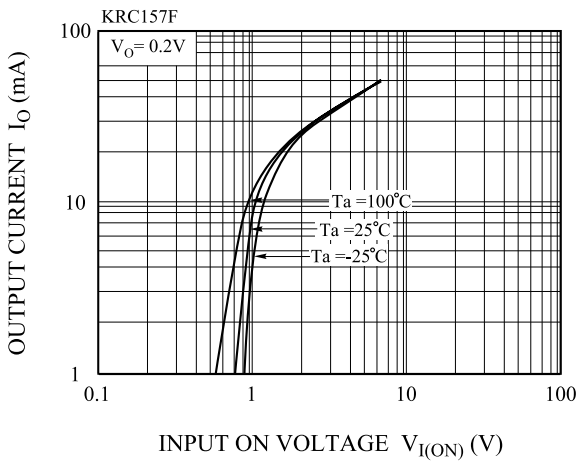

$I_O - V_{I(OFF)}$

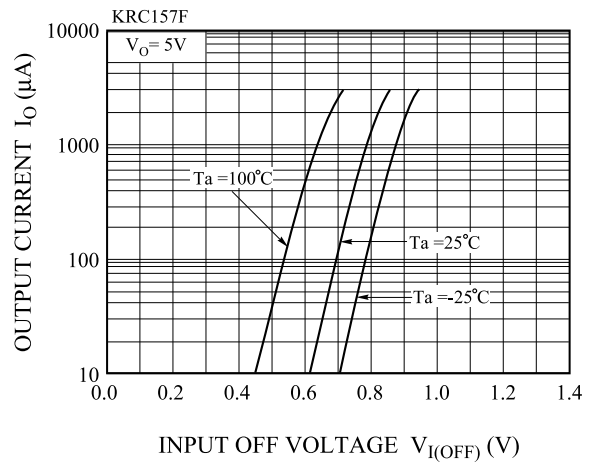

$G_I - I_O$

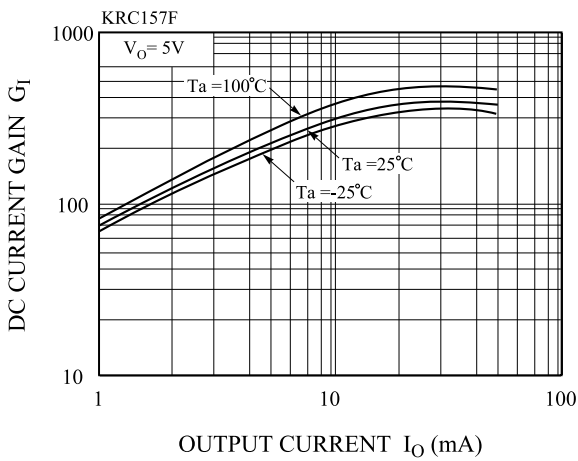

$V_{O(ON)} - I_O$

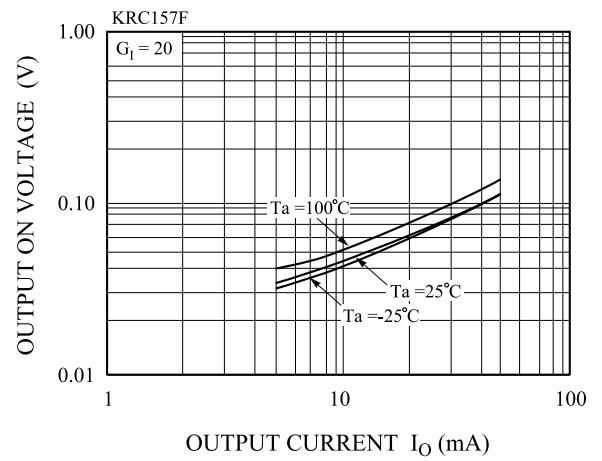

$I_O - V_{I(ON)}$

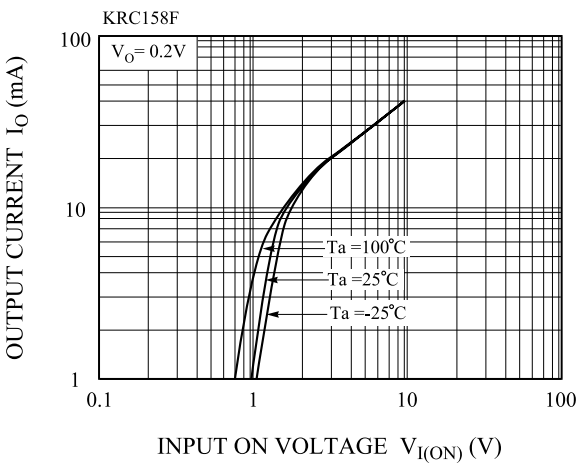

$I_O - V_{I(OFF)}$

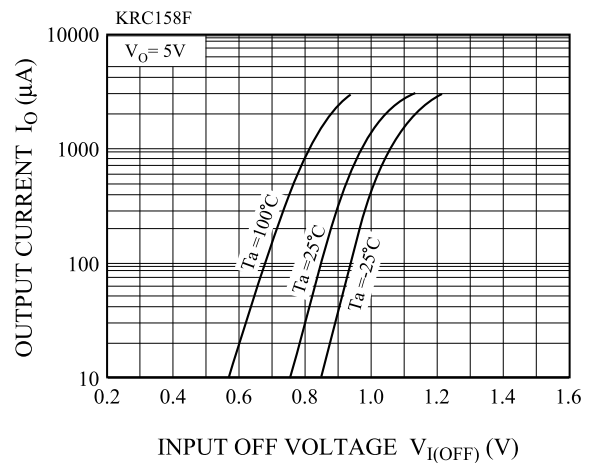

KRC157F~KRC159F

$G_I - I_O$

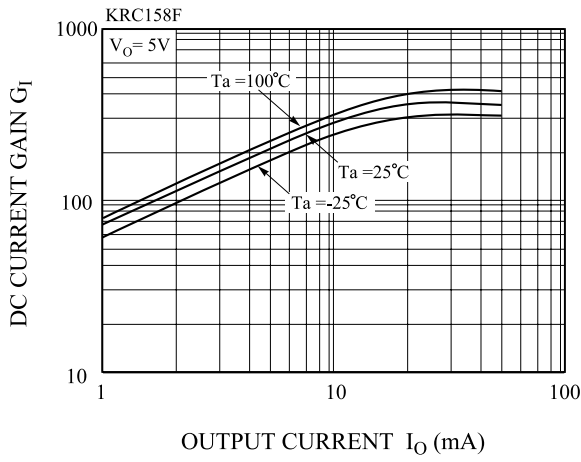

$V_{O(ON)} - I_O$

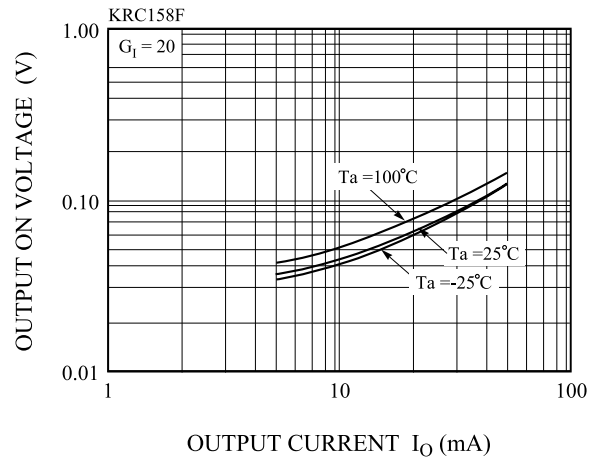

$I_O - V_{I(ON)}$

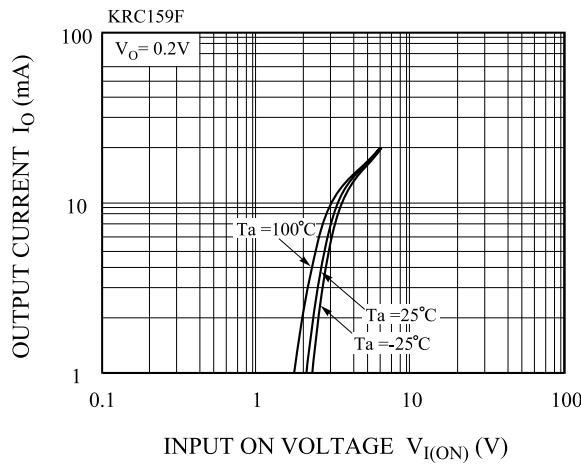

$I_O - V_{I(OFF)}$

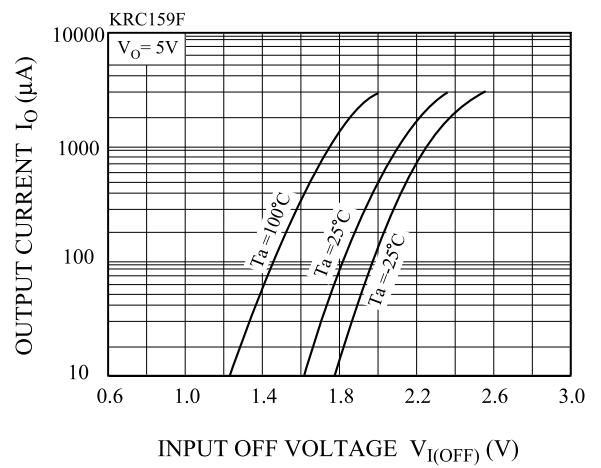

$G_I - I_O$

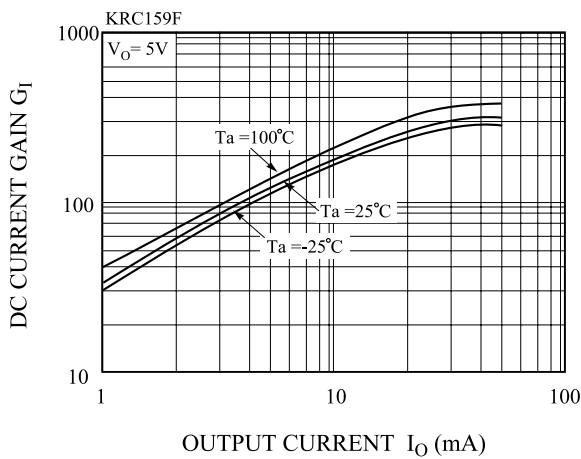

$V_{O(ON)} - I_O$

