

DETAILS

Product Number	FCA14295_BILLIE-B
Family	Billie
Type	Assembly
Color	white
Diameter	21,5 mm
Height	16,1 mm
Style	round
Optic Material	PMMA
Holder Material	
Fastening	pin, tape
Status	production ready
ROHS Compliant	Yes
Date Updated	25/08/2016



OPTICAL PROPERTIES

LED	Viewing Angle	Light Beam	Efficiency	cd/lm	Connector
XP-G	asymmetric deg	Asymmetric	93 %	2.300	-
XP-E	asymmetric deg	Asymmetric	94 %	2.500	-
LUXEON Rebel	asymmetric deg	Asymmetric	93 %	2.100	-
LUXEON Rebel ES	asymmetric deg	Asymmetric	92 %	2.000	-
NCSxx19B	asymmetric deg	Asymmetric	92 %	2.100	-
NVSxx19B/NVSxx19C	asymmetric deg	Asymmetric	91 %	1.800	-
NF2x757D	asymmetric deg	Asymmetric	93 %	1.900	-
NF2x757G	sim: Asymmetric	Asymmetric	sim: 93 %	sim: 2.000	-
Oslon Square EC	asymmetric deg	Asymmetric	93 %	2.000	-
Duris S5 (2 chip)	asymmetric deg	Asymmetric	93 %	1.900	-
LH351Z	asymmetric deg	Asymmetric	94 %	2.300	-
LH351B	asymmetric deg	Asymmetric	93 %	2.100	-
Z5M1/Z5M2	asymmetric deg	Asymmetric	94 %	2.200	-

D

C

B

A

4

4

8.6

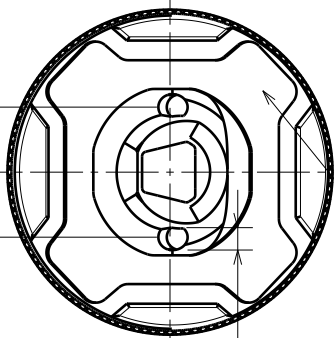

Tape 0,4 mm

1.48

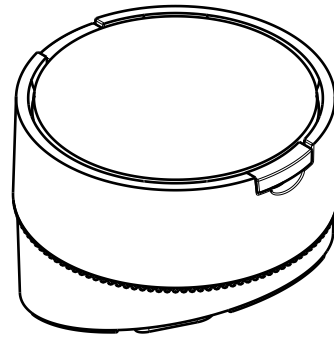

Isometric view

Bottom view

3

3

16.19

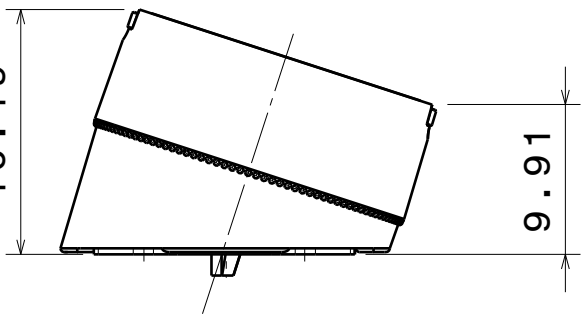

9.91

Front view

∅21.49

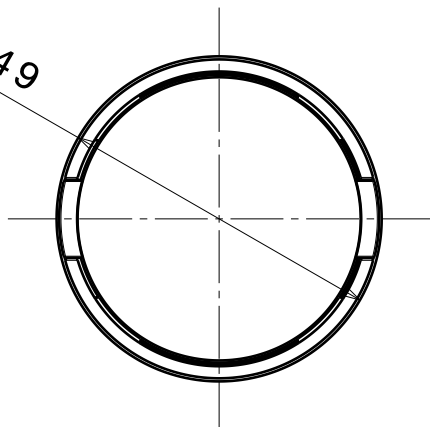

Top view

2

2

1

1

Tolerances if not otherwise shown
 According to DIN ISO 2768-1
 Linear measures:
 Up to 30mm class M, otherwise class C.
 According to DIN ISO 2768-2
 Form and position: class L



Ledil Oy
 Salorankatu 10
 FIN 24240 SALO
 Finland

THIRD ANGLE PROJECTION:

DRAWING TITLE
BILLIE datasheet

This drawing is the property of LEDiL Oy. It may not be reproduced, copied or communicated without a written agreement with LEDiL Oy."

SIZE	PART NUMBER		
A4			

SCALE	2:1	WEIGHT	-	SHEET	1/1
-------	-----	--------	---	-------	-----

D

A

Luminaire: LEDiL Oy FCA14295_BILLIE-B_(XP-G)

Lamps: 1 x Cree_XP-G_(XPGWHT-L1-CWPI-00BE7)_67.1176lm@250mA_CCT=3061K_P=0.769392W_I=0.2499A

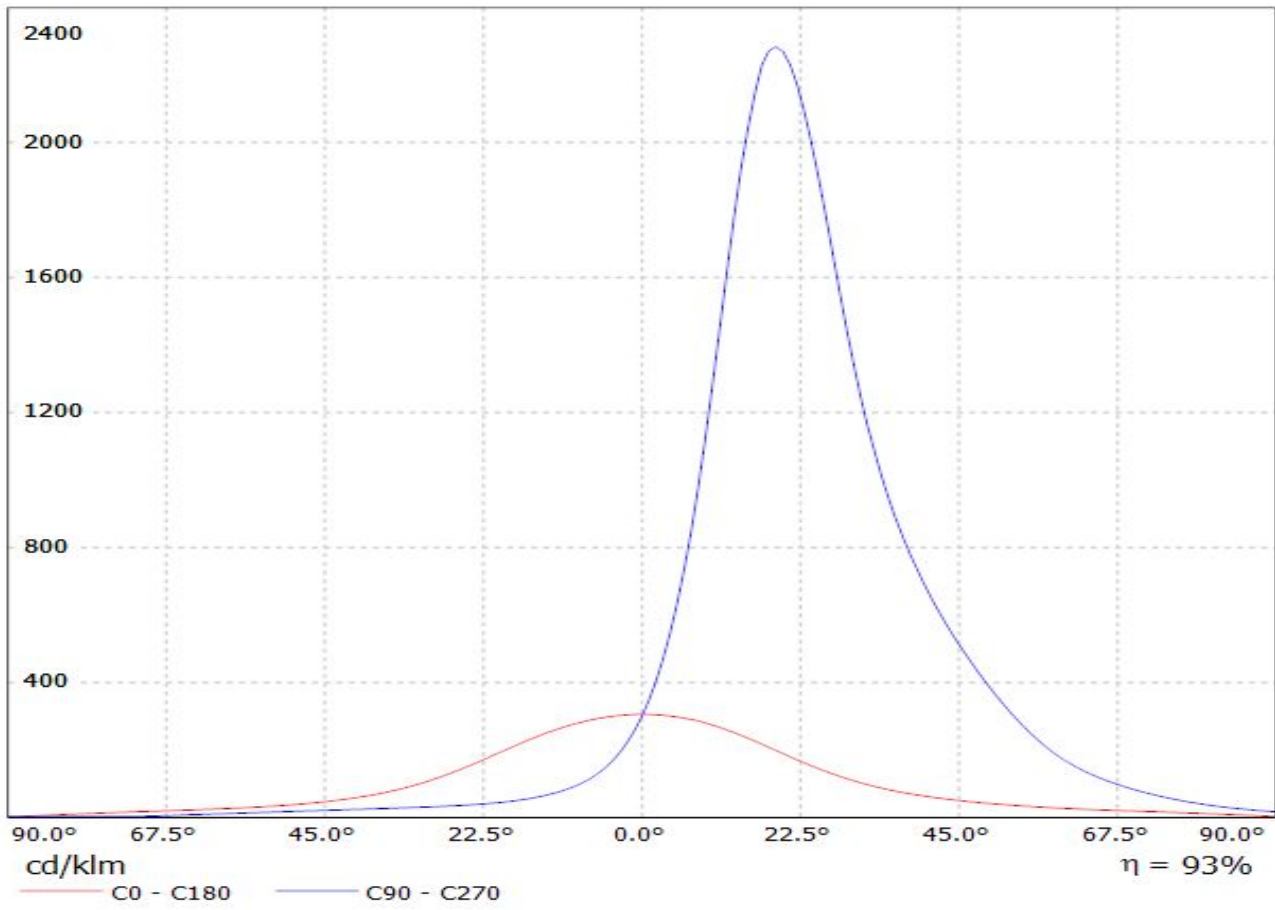

Luminaire: LEDiL Oy FCA14295_BILLIE-B_(XP-E)

Lamps: 1 x Cree_XP-E_(XPEWHT-L1-3C0-Q5-0-06)_77.7798lm@250mA_P=0.801004W_I=0.2499A

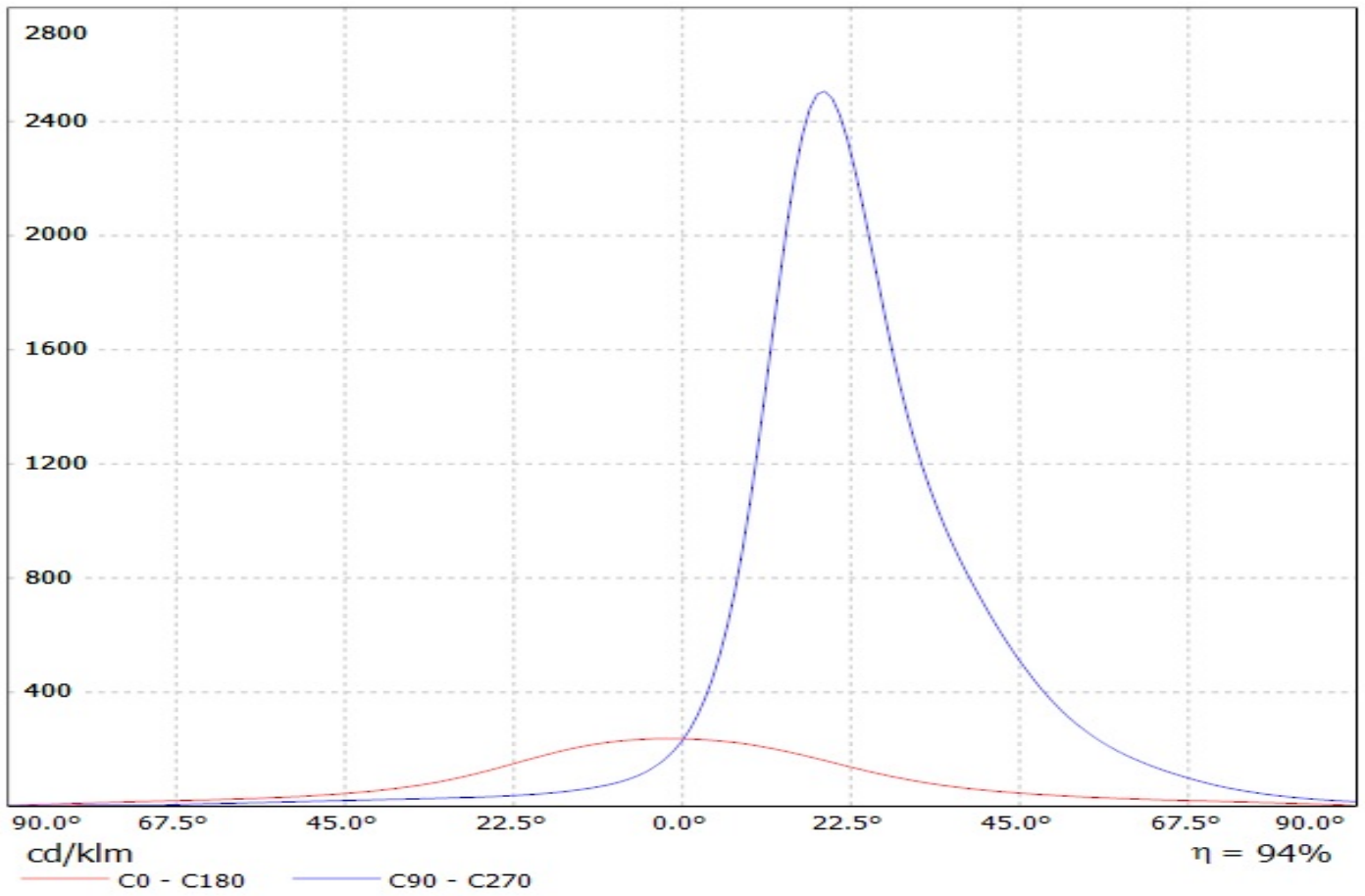

Luminaire: Ledil FCA14295_BILLIE-B_(Luxeon_Rebel_ES)
Lamps: 1 x Luxeon_Rebel_ES_91.0375lm@250mA_P=0.73W_I=0.25A

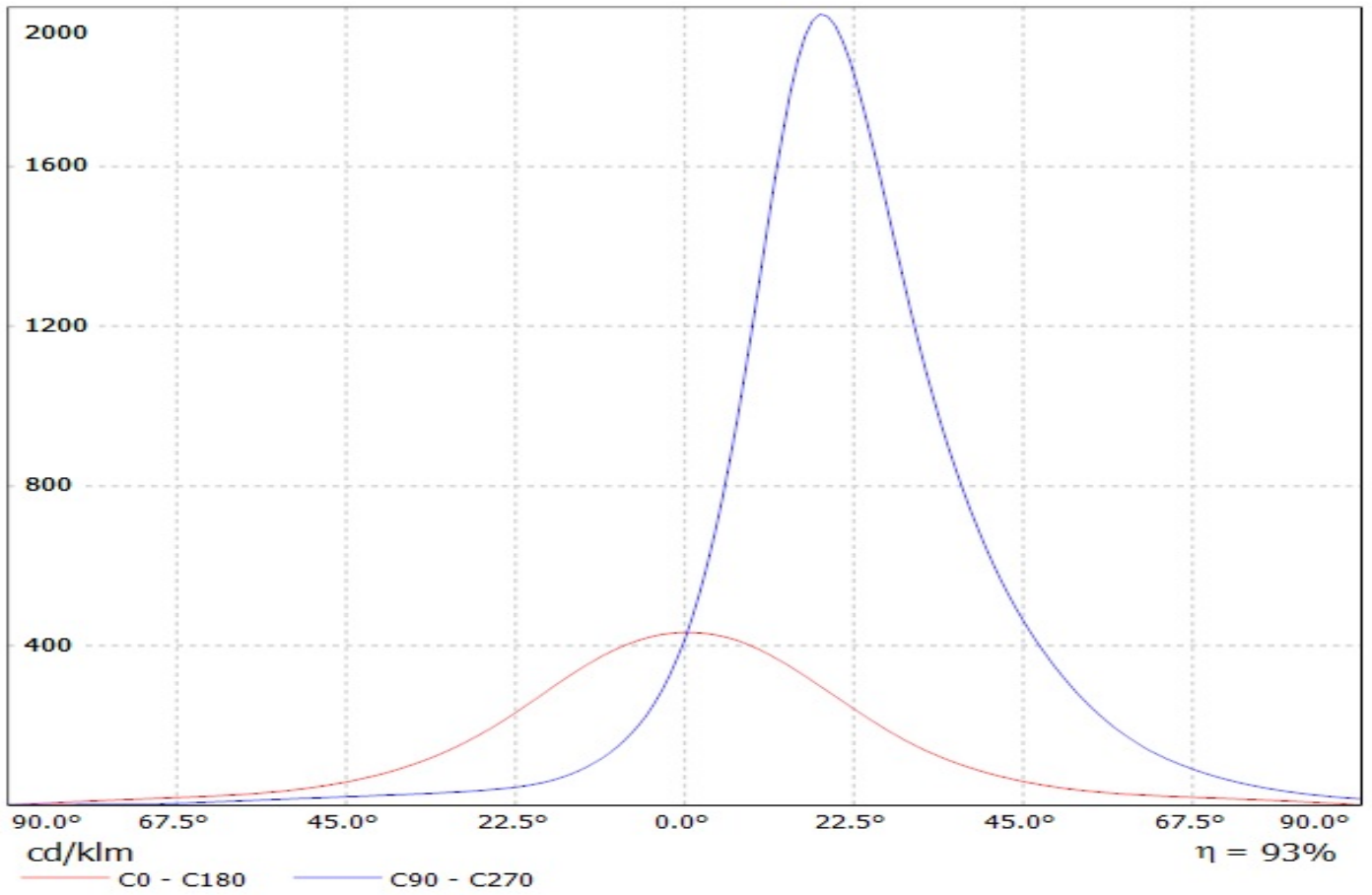

Luminaire: LEDiL Oy FCA14295_BILLIE-B_(NCSxx19B)

Lamps: 1 x Nichia_NCSxx19B_(NCSL119BE)_91.169lm@250mA_P=0.795532W_I=0.2499A

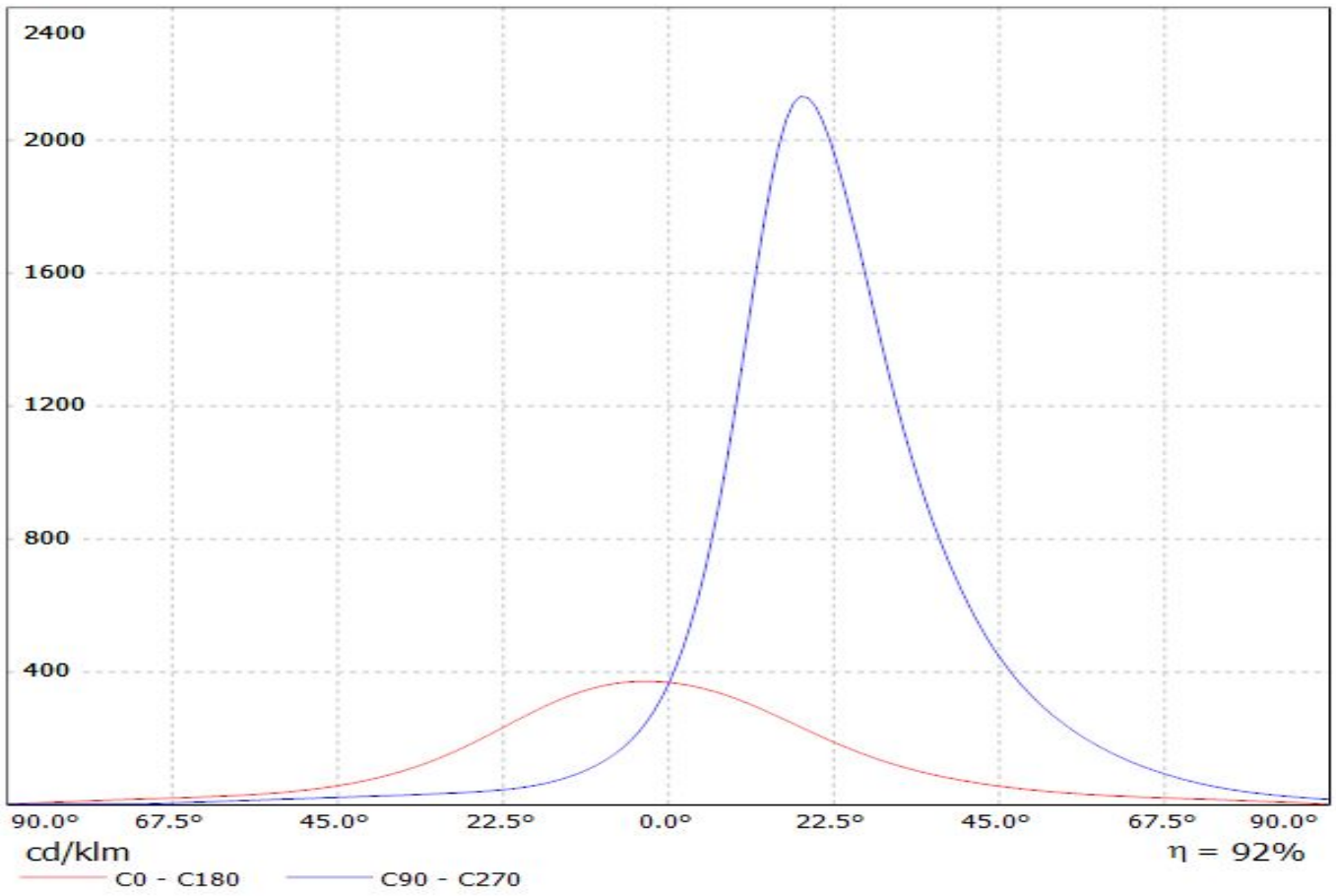

Luminaire: LEDiL Oy FCA14295_BILLIE-B_(NVSxx19B)

Lamps: 1 x Nichia_NVsxx19B_108.673lm@250mA_P=0.776189W_I=0.2499A

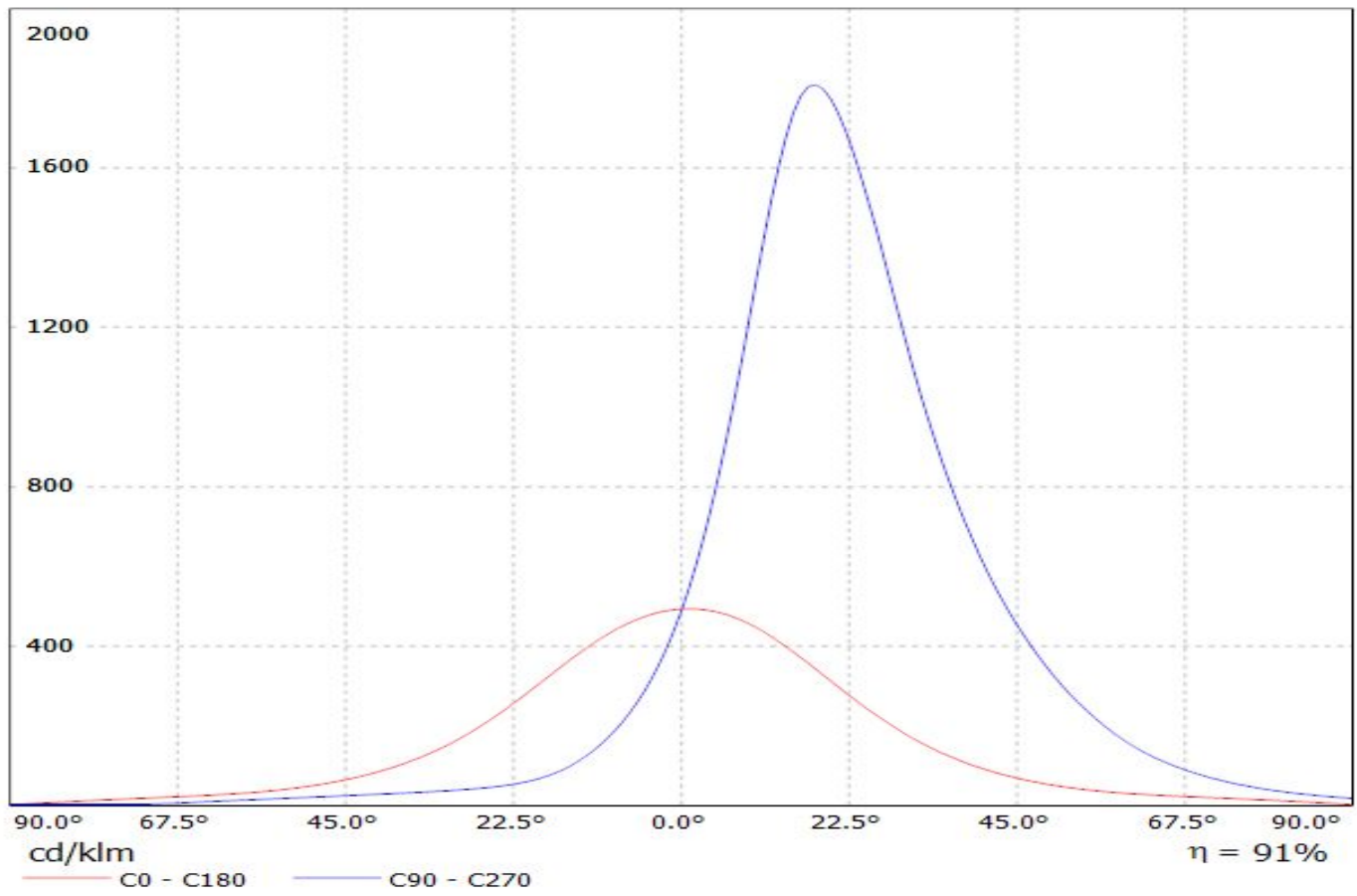

Luminaire: Ledil FCA14295_BILLIE-B_(NF2x757D)
Lamps: 1 x Nichia_NF2x757D_53.1588lm@65mA_P=0.3744W_I=0.065A

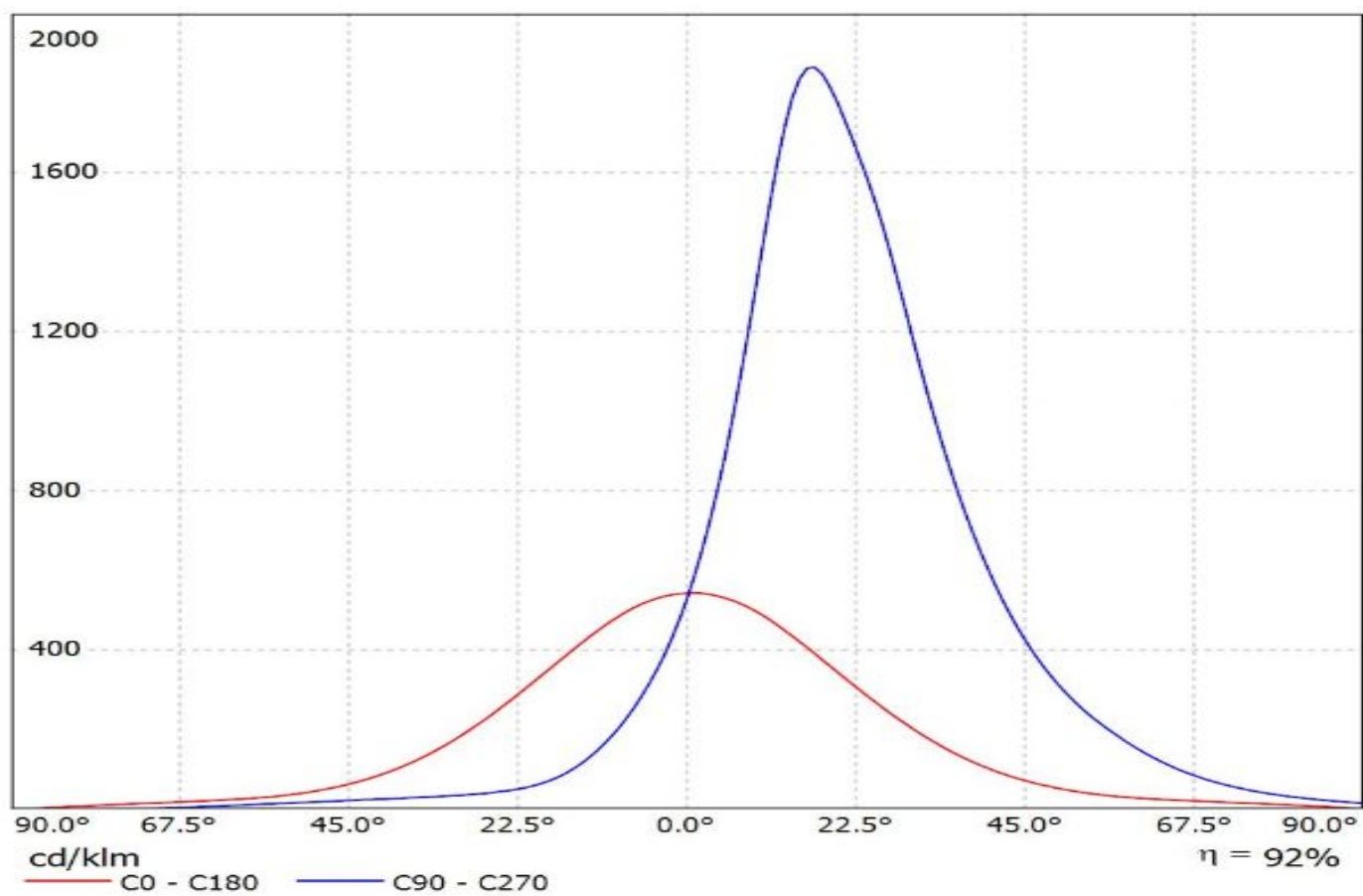

Luminaire: LEDiL Oy FCA14295_BILLIE-B_(Oslon_Square_EC)
Lamps: 1 x Osram_Oslon_Square_EC_(GW_CSSRM1.EC)_85.7621lm@250mA_P=0.738355W_I=0.2499A

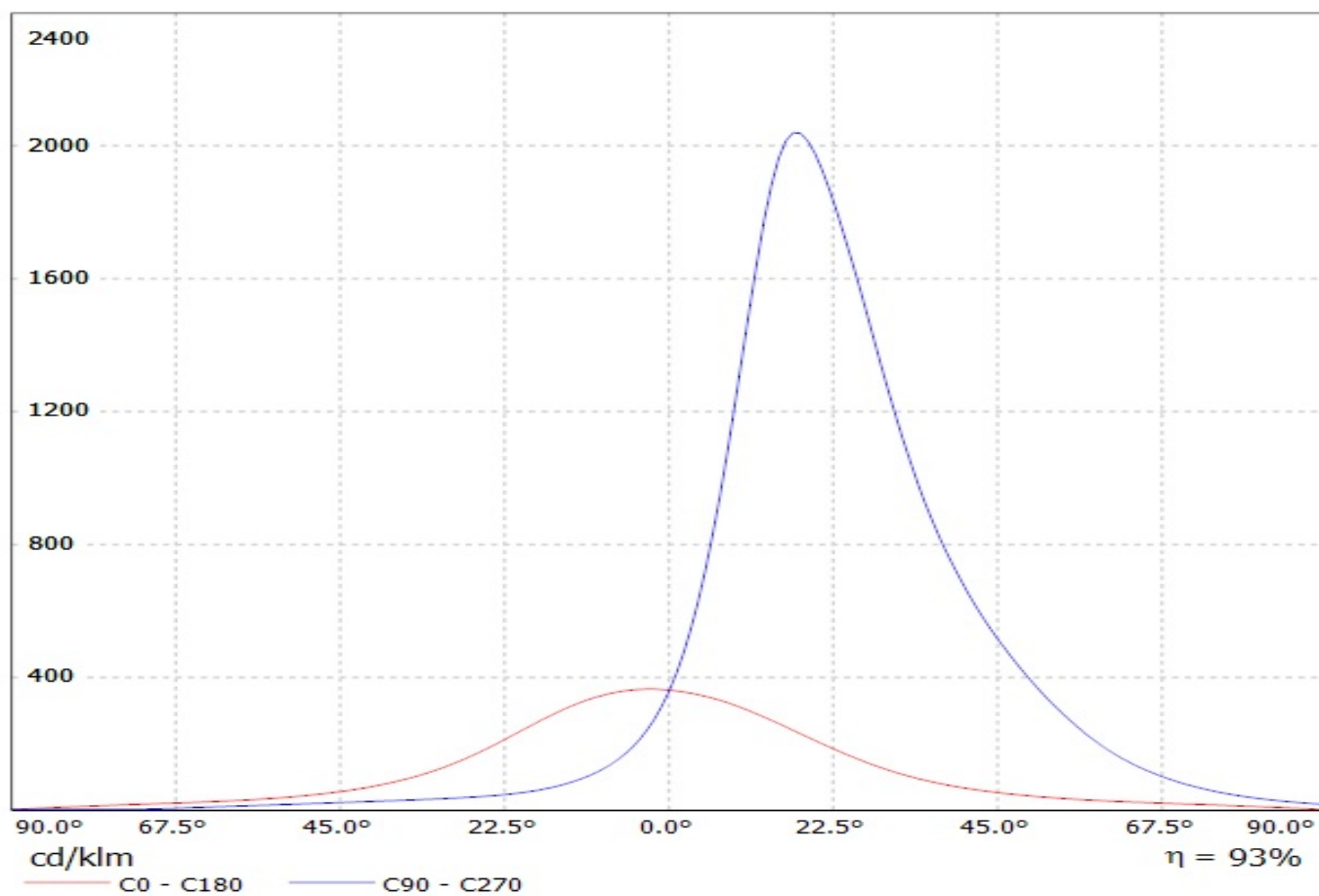

Luminaire: LEDiL Oy FCA14295_BILLIE-B_(Duris_S5_(2_chip))

Lamps: 1 x Osram_Duris_S5_(2_chip)_(GW_PSLRS1.EC-LQLS-5H7I-1)_123.51lm@150mA_P=0.932856W_I=0.1501A

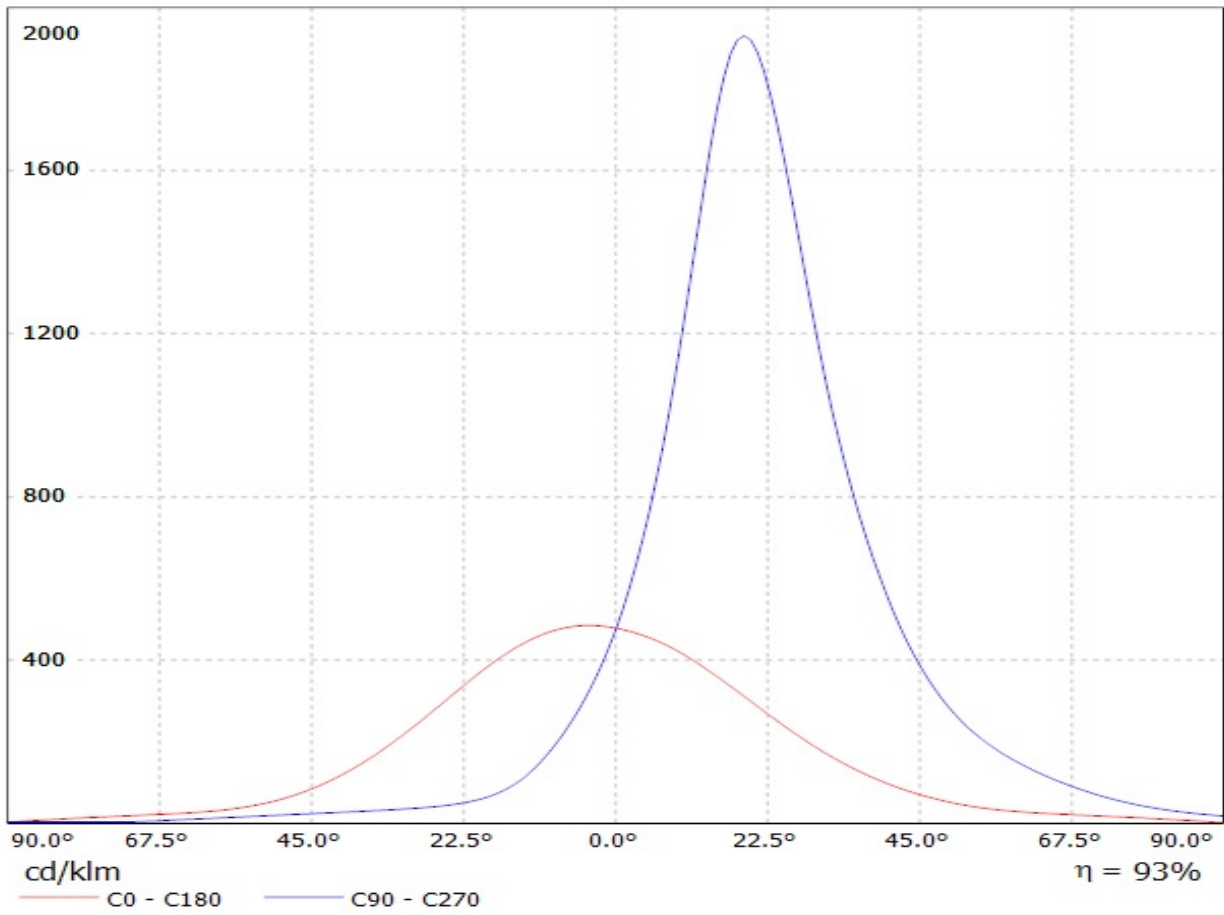

Luminaire: LEDiL Oy FCA14295_BILLIE-B_(LH351Z)
Lamps: 1 x Samsung_LH351Z_91.6272lm@250mA_CCT=6506K_P=0.746301W_I=0.2499A

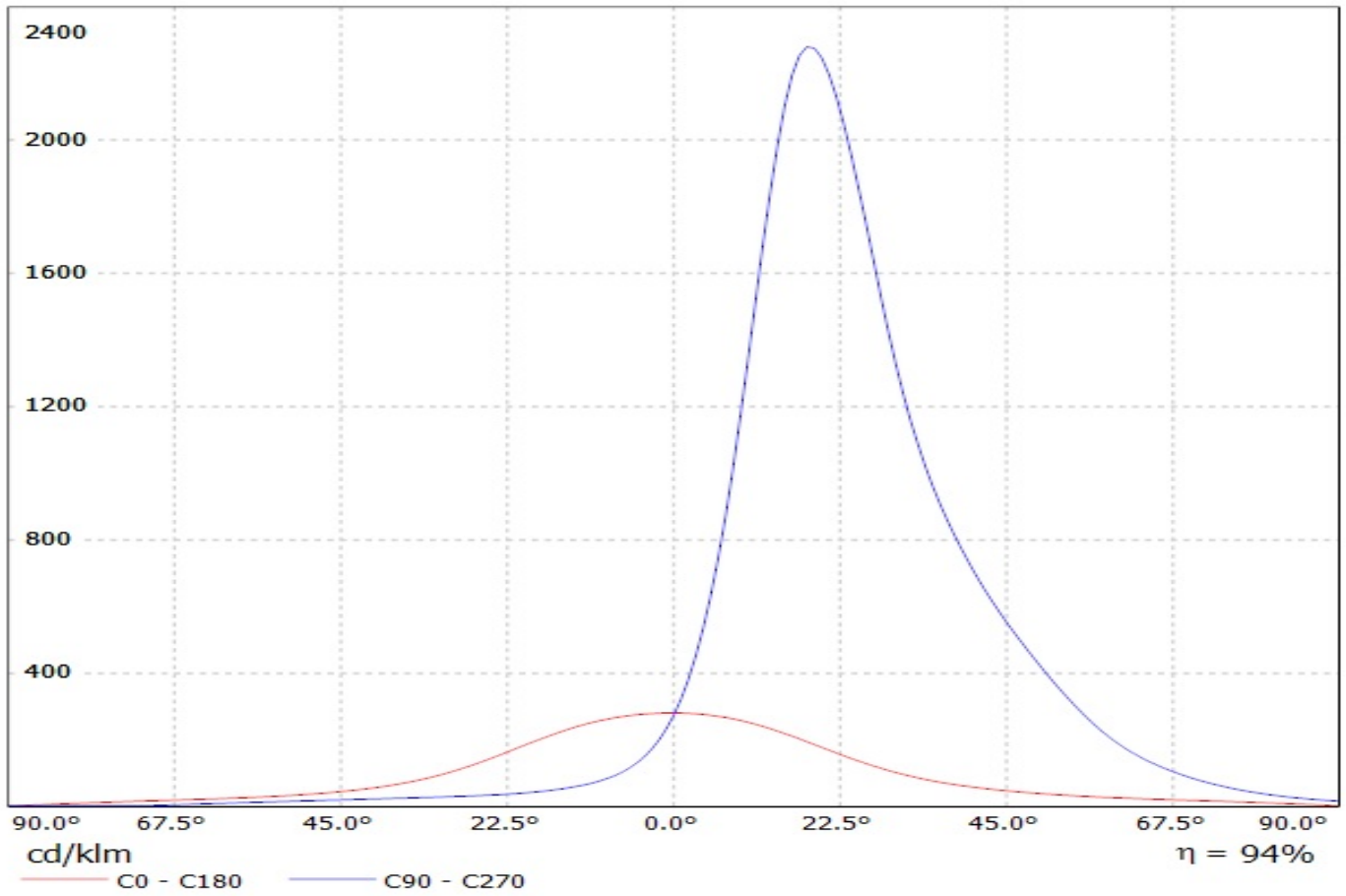

Luminaire: LEDiL Oy FCA14295_BILLIE-B_(Z5M1)

Lamps: 1 x Seoul_Z5M1_(SZ5-M1-W0-C8)_111.713lm@250mA_P=0.745402W_I=0.2499A

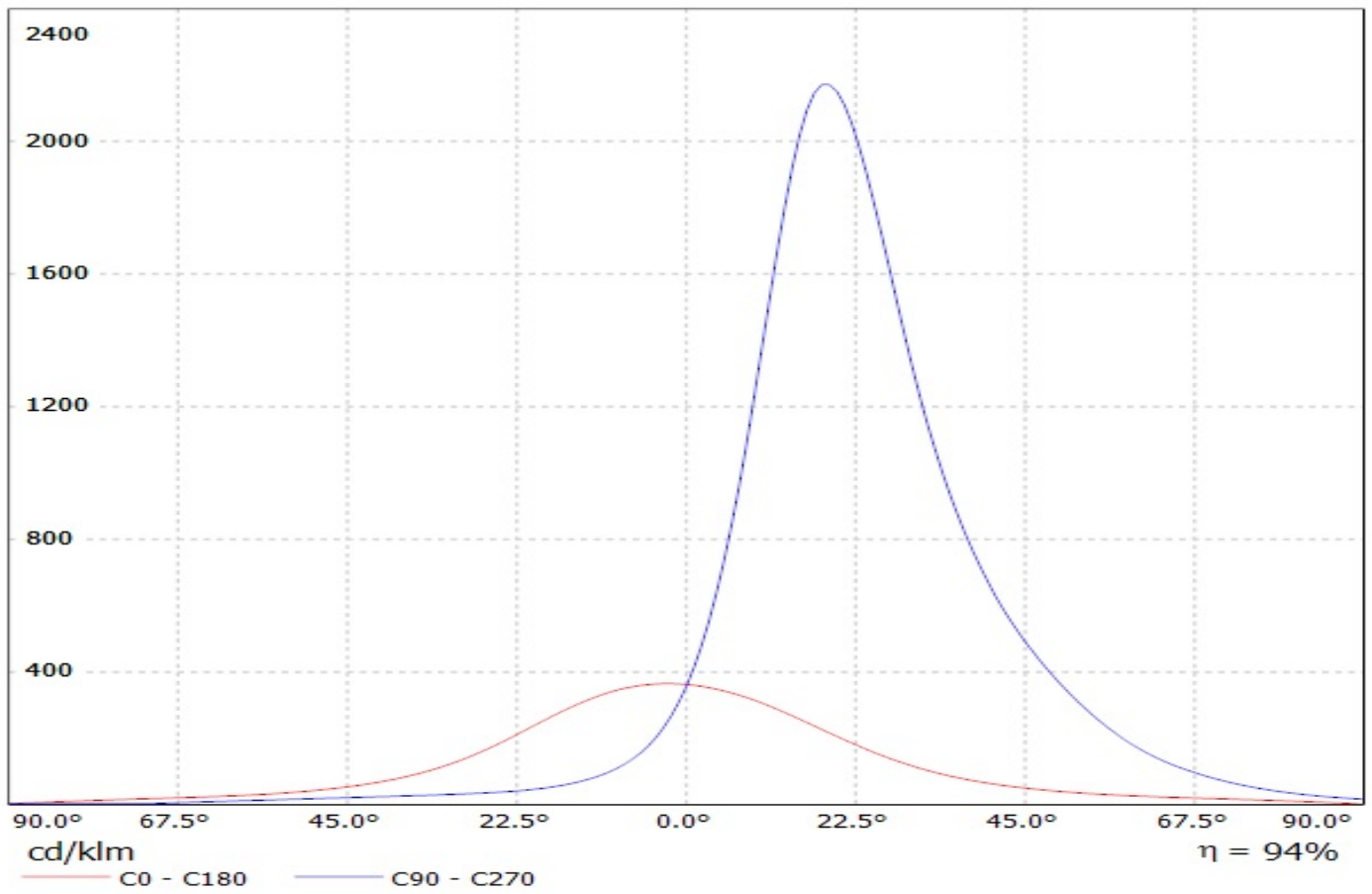

Luminaire: LEDiL Oy FCA14295_BILLIE-B_(XP-G)

Lamps: 1 x Cree_XP-G_(XPGWHT-L1-CWPI-00BE7)_67.1176lm@250mA_CCT=3061K_P=0.769392W_I=0.2499A

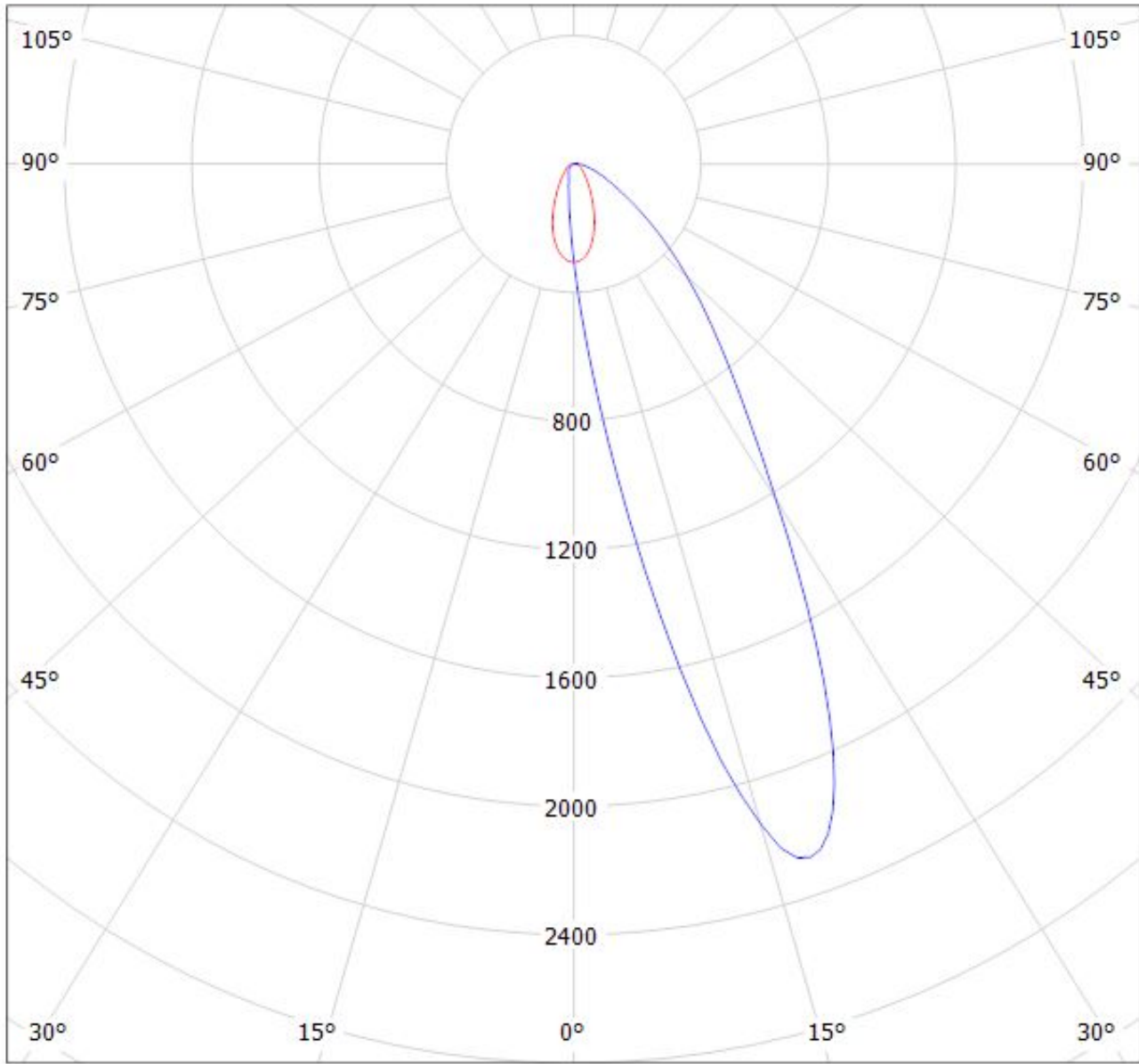

cd/klm

$\eta = 93\%$

— C0 - C180 — C90 - C270

Luminaire: LEDiL Oy FCA14295_BILLIE-B_(XP-E)

Lamps: 1 x Cree_XP-E_(XPEWHT-L1-3C0-Q5-0-06)_77.7798lm@250mA_P=0.801004W_I=0.2499A

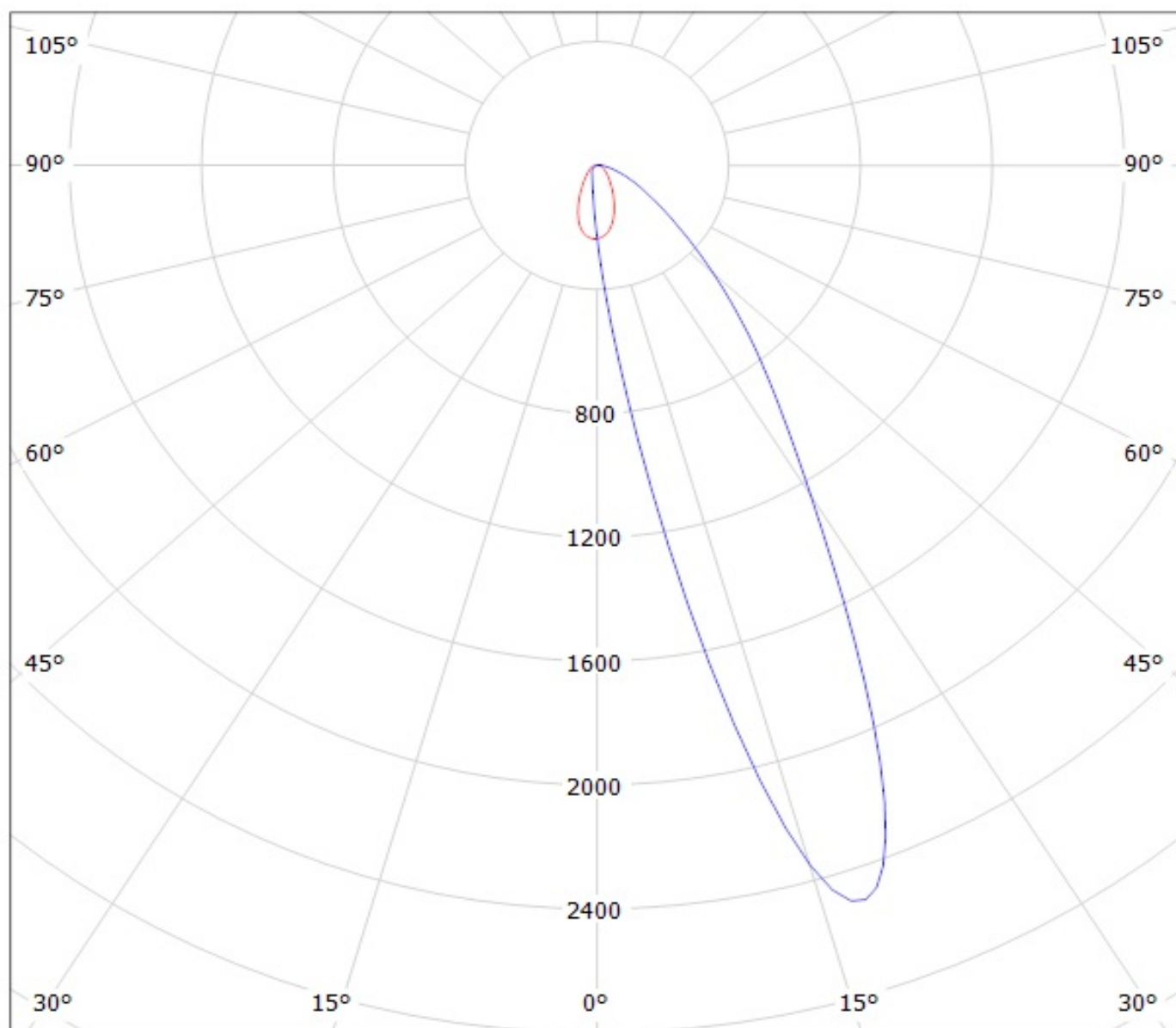

cd/klm

— C0 - C180

— C90 - C270

$\eta = 94\%$

Luminaire: Ledil FCA14295_BILLIE-B_(Luxeon_Rebel)
Lamps: 1 x Luxeon_Rebel_62.1381lm@250mA_P=0.7275W_I=0.25A

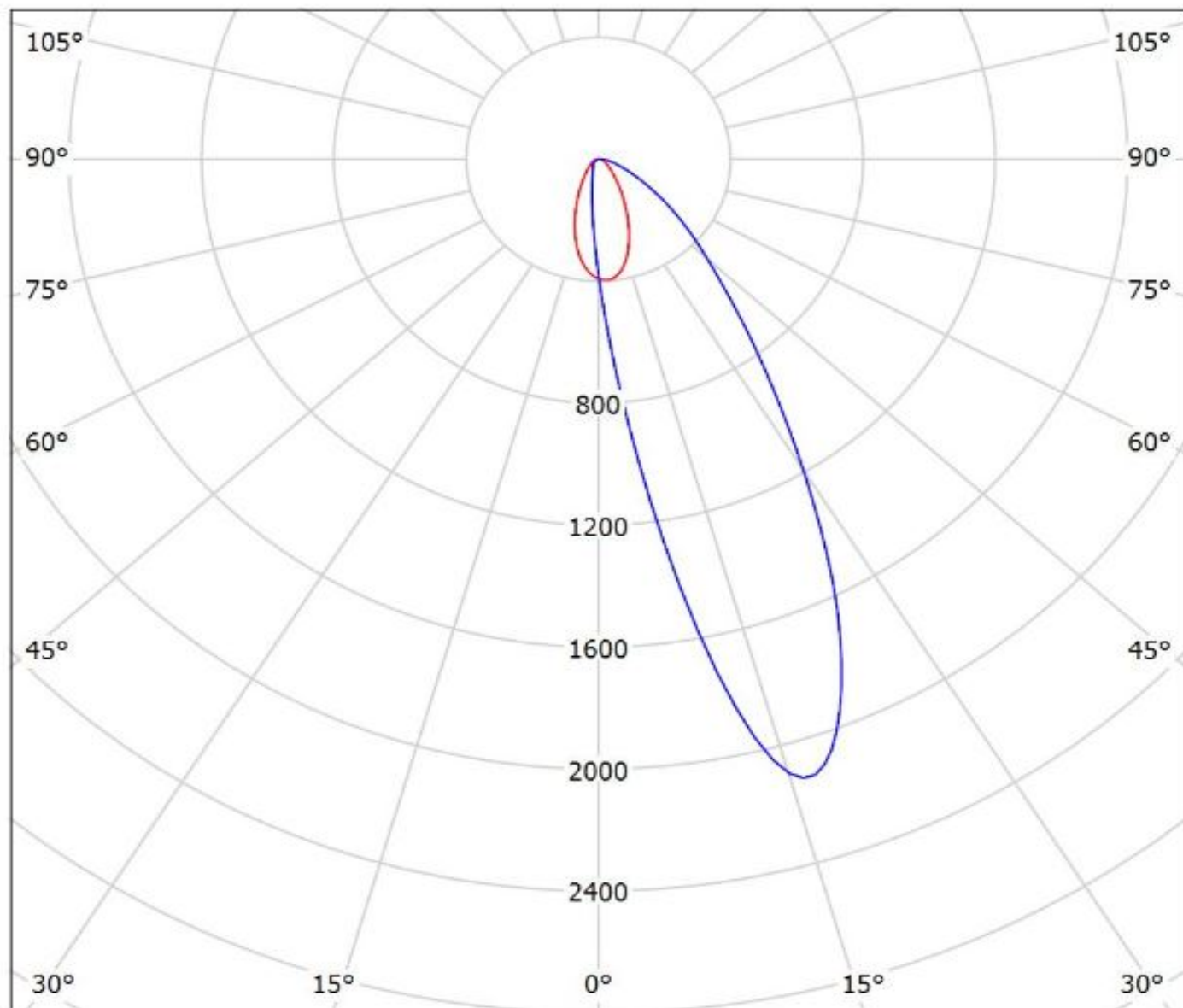

cd/klm

— C0 - C180 — C90 - C270

$\eta = 93\%$

Luminaire: Ledil FCA14295_BILLIE-B_(Luxeon_Rebel_ES)
Lamps: 1 x Luxeon_Rebel_ES_91.0375lm@250mA_P=0.73W_I=0.25A

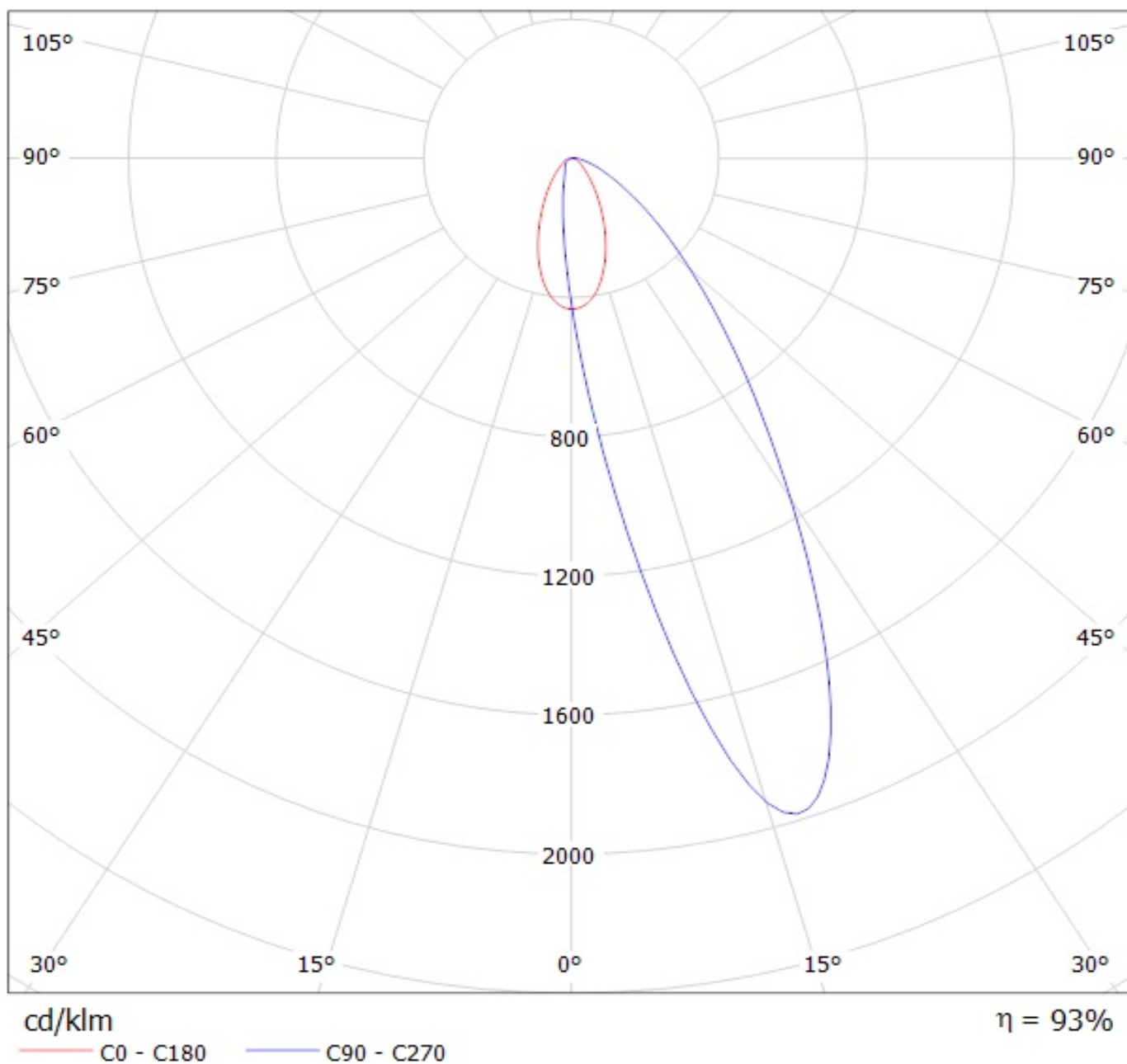

Luminaire: LEDiL Oy FCA14295_BILLIE-B_(NCSxx19B)

Lamps: 1 x Nichia_NCSxx19B_(NCSL119BE)_91.169lm@250mA_P=0.795532W_I=0.2499A

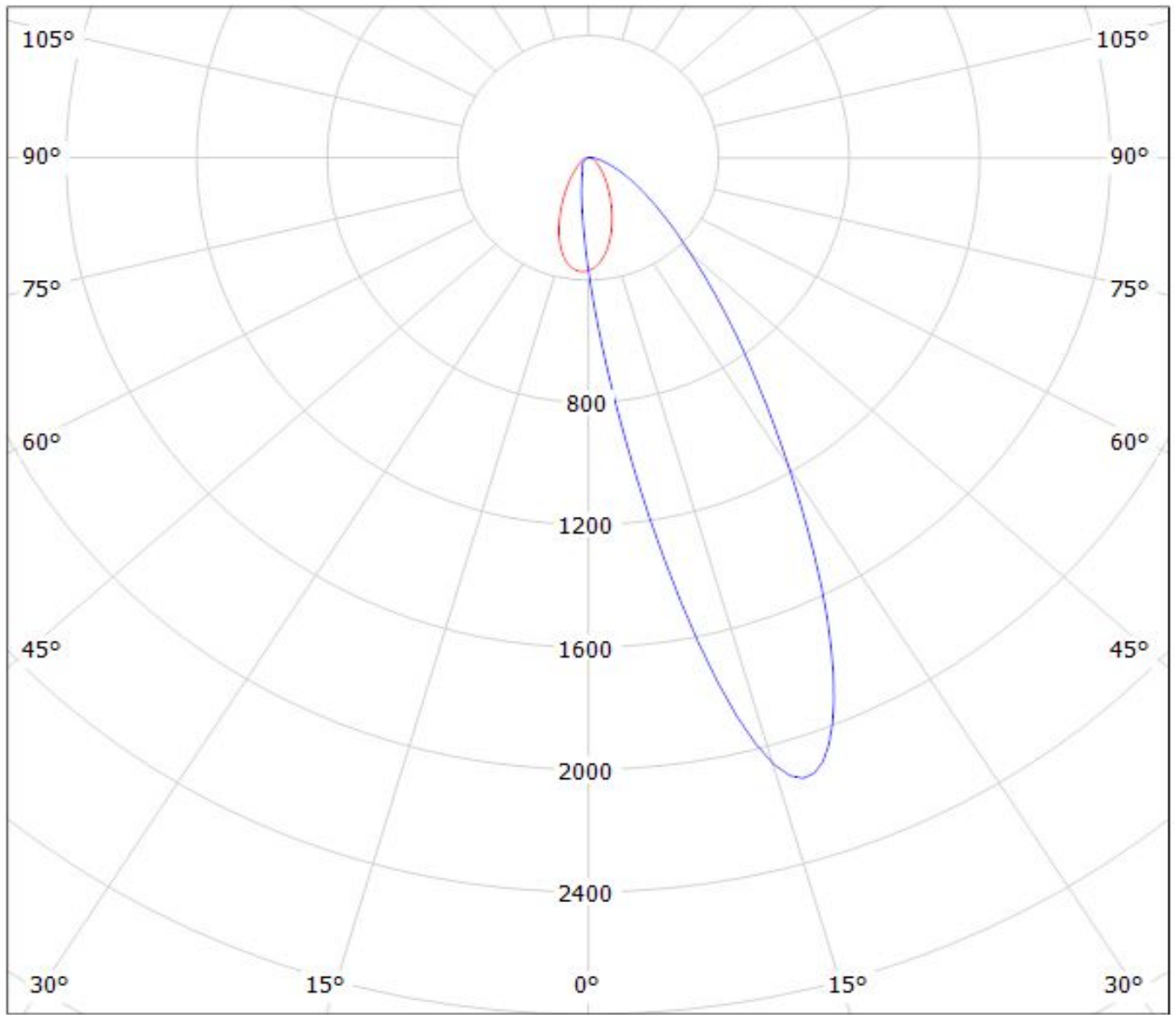

cd/klm

— C0 - C180

— C90 - C270

$\eta = 92\%$

Luminaire: LEDiL Oy FCA14295_BILLIE-B_(NVSxx19B)

Lamps: 1 x Nichia_NVsxx19B_108.673lm@250mA_P=0.776189W_I=0.2499A

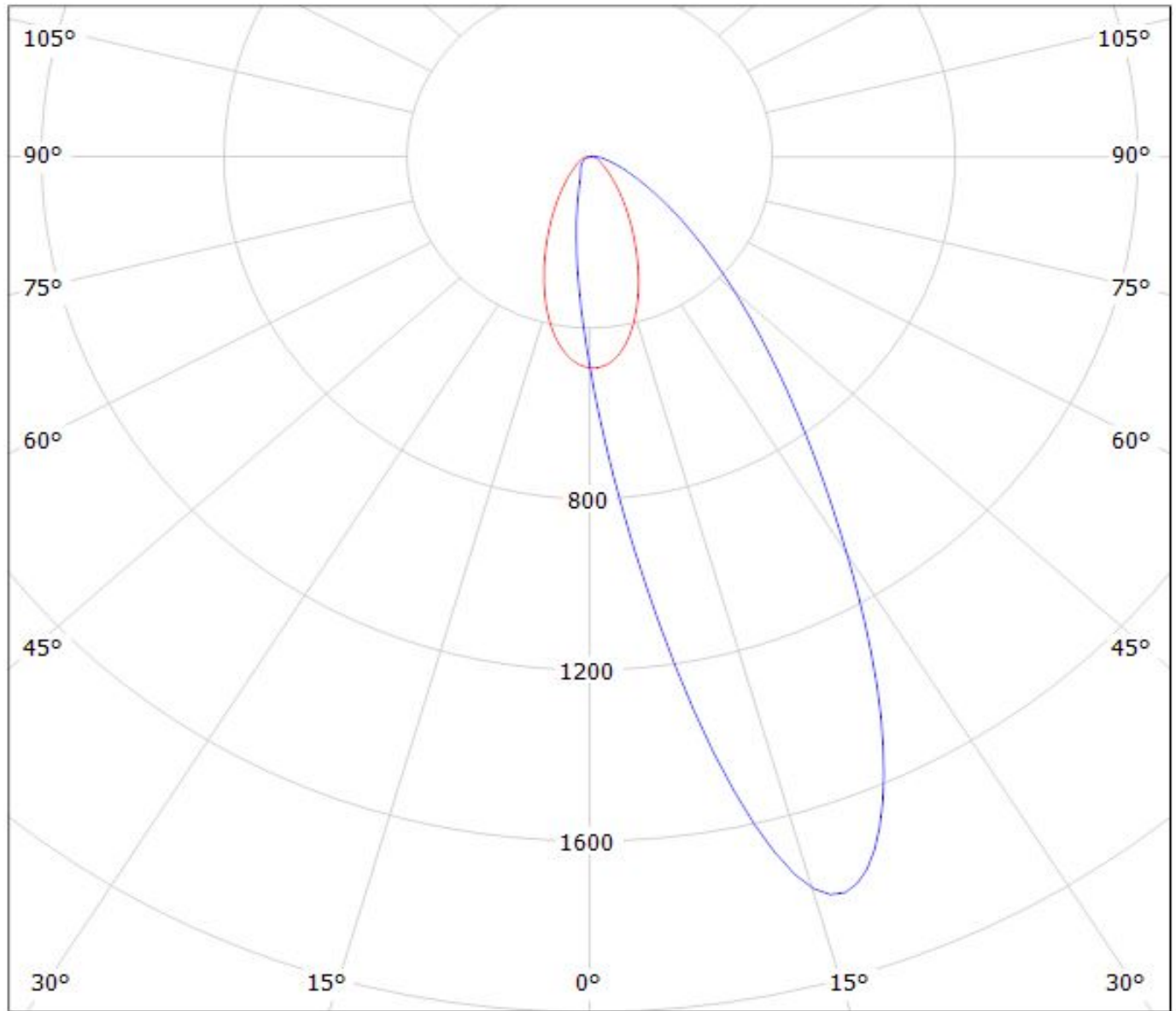

cd/klm

— C0 - C180

— C90 - C270

$\eta = 91\%$

Luminaire: Ledil FCA14295_BILLIE-B_(NF2x757D)

Lamps: 1 x Nichia_NF2x757D_53.1588lm@65mA_P=0.3744W_I=0.065A

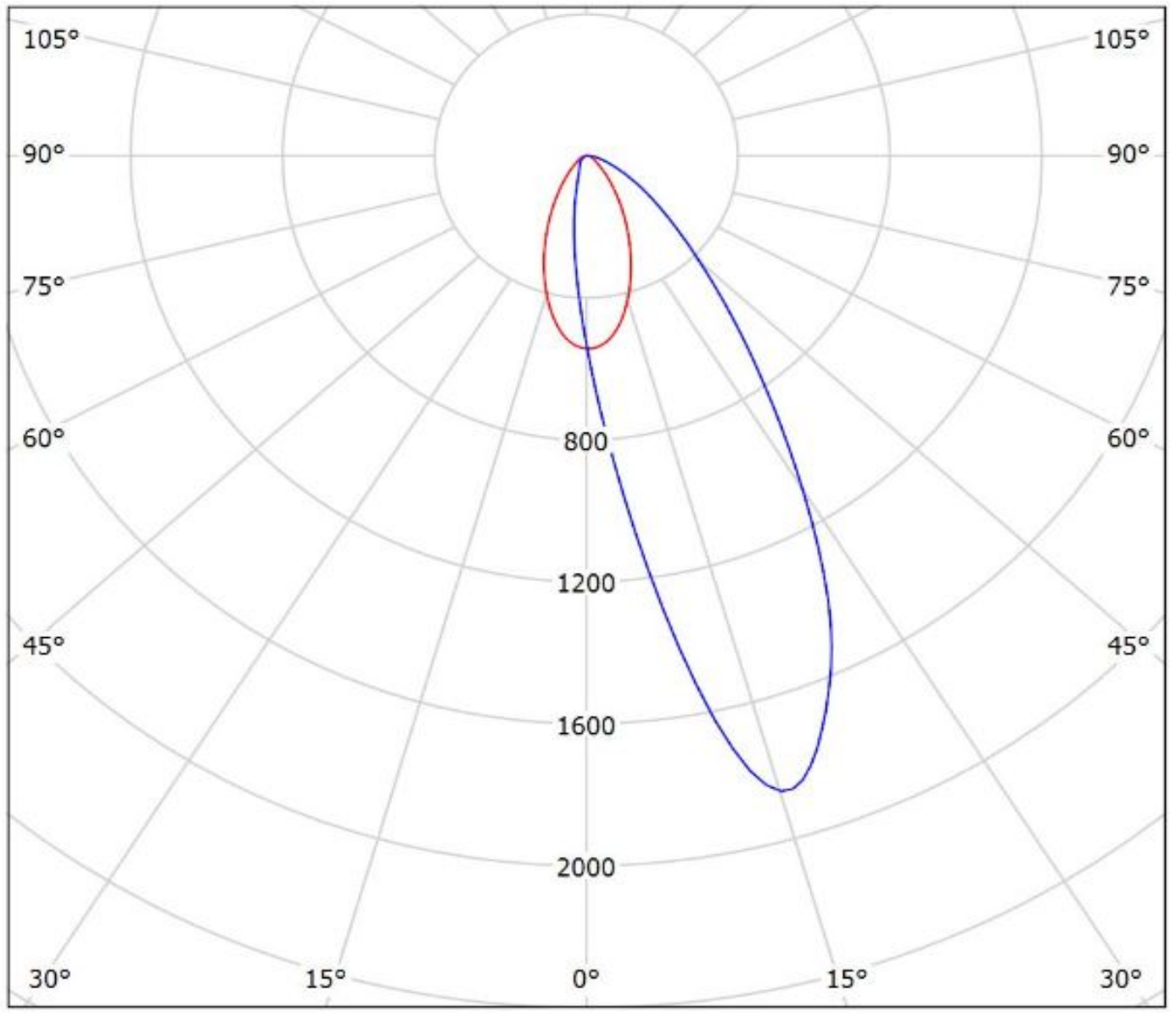

cd/klm

— C0 - C180

— C90 - C270

$\eta = 92\%$

Luminaire: LEDiL Oy FCA14295_BILLIE-B_(Oslon_Square_EC)

Lamps: 1 x Osram_Oslon_Square_EC_(GW_CSSRM1.EC)_85.7621lm@250mA_P=0.738355W_I=0.2499A

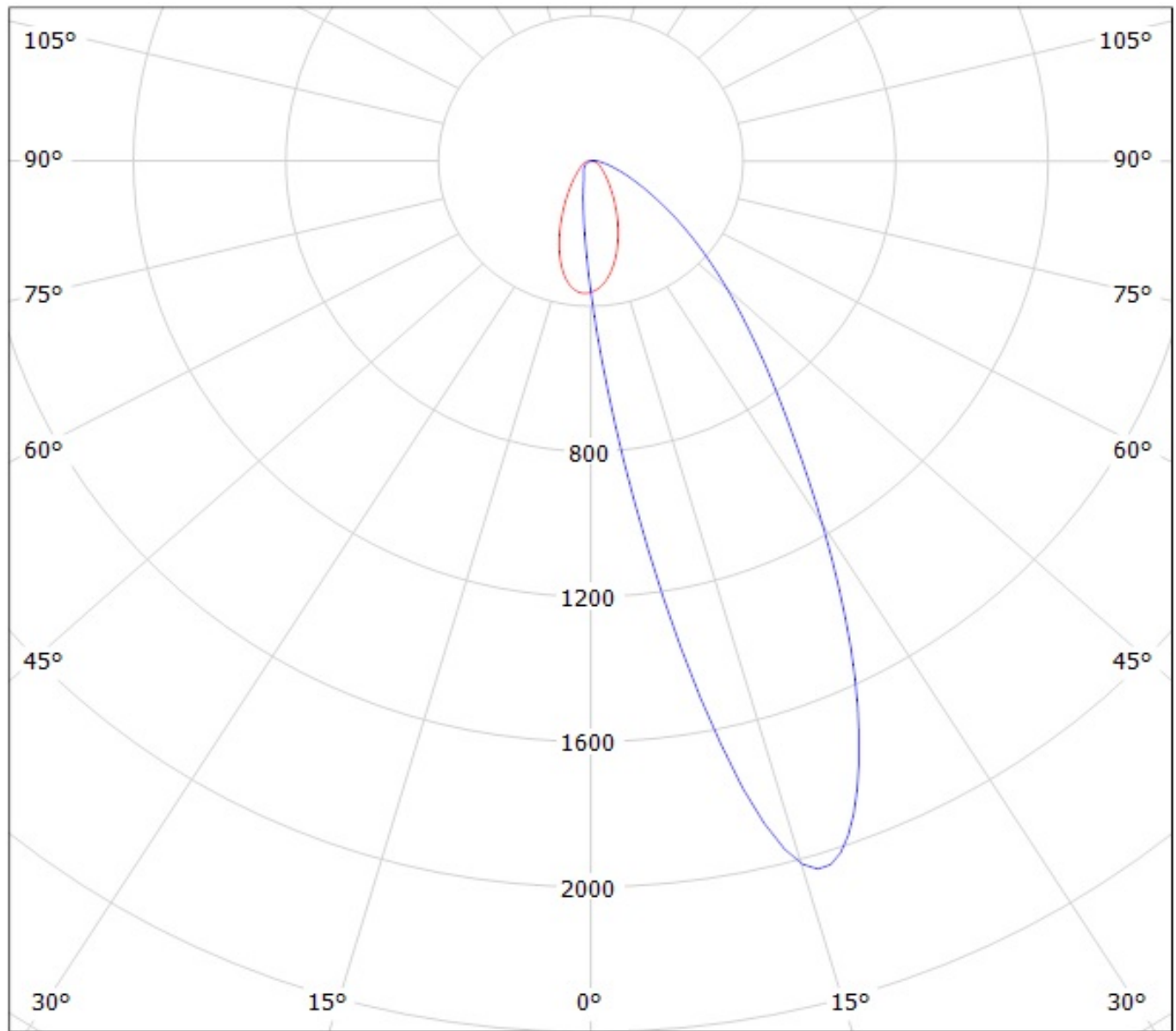

cd/klm

— C0 - C180 — C90 - C270

$\eta = 93\%$

Luminaire: LEDiL Oy FCA14295_BILLIE-B_(Duris_S5_(2_chip))

Lamps: 1 x Osram_Duris_S5_(2_chip)_(GW_PSLRS1.EC-LQLS-5H7I-1)_123.5lm@150mA_P=0.932856W_I=0.1501A

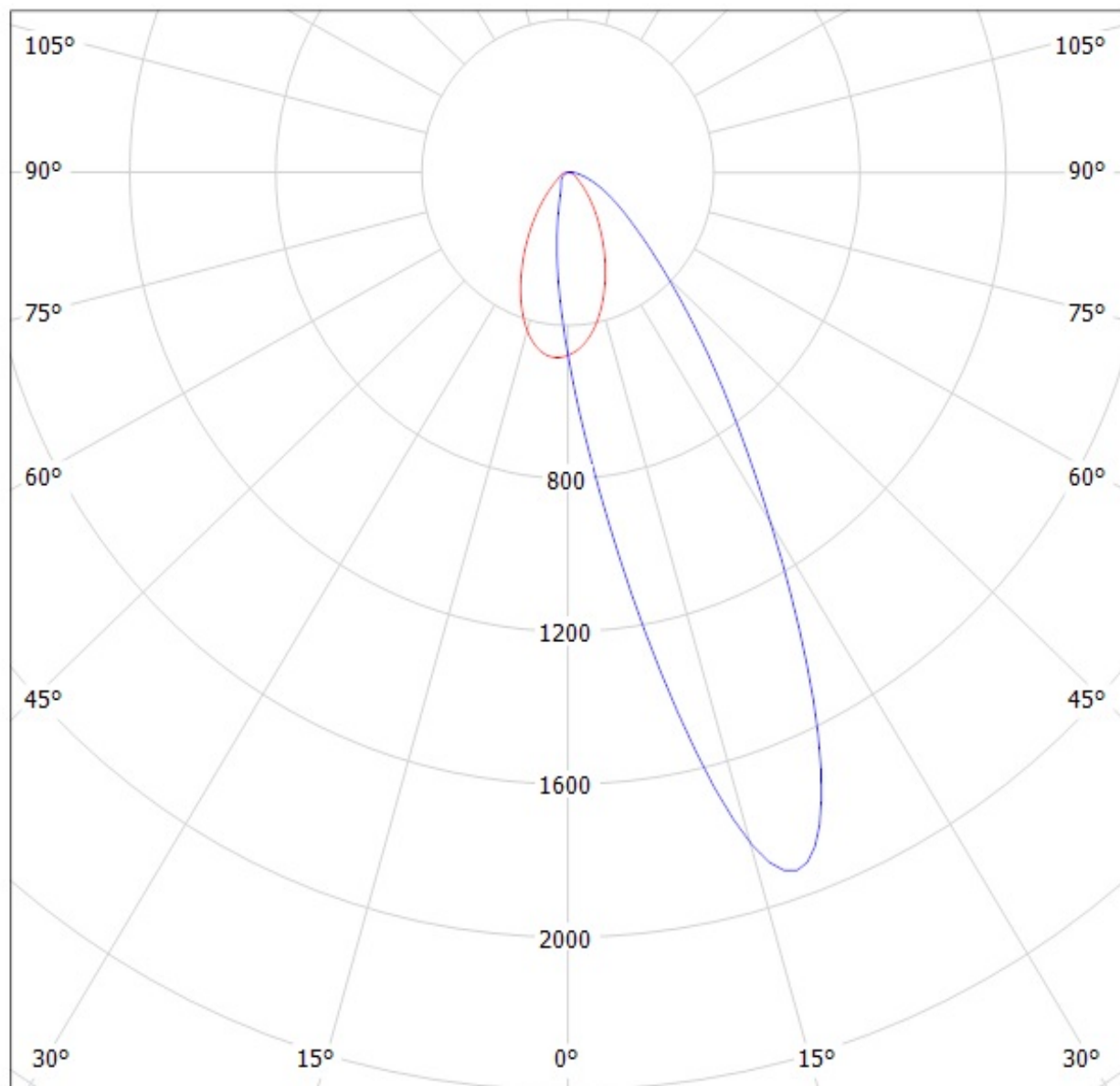

cd/klm

— C0 - C180 — C90 - C270

$\eta = 93\%$

Luminaire: LEDiL Oy FCA14295_BILLIE-B_(LH351Z)

Lamps: 1 x Samsung_LH351Z_91.6272lm@250mA_CCT=6506K_P=0.746301W_I=0.2499A

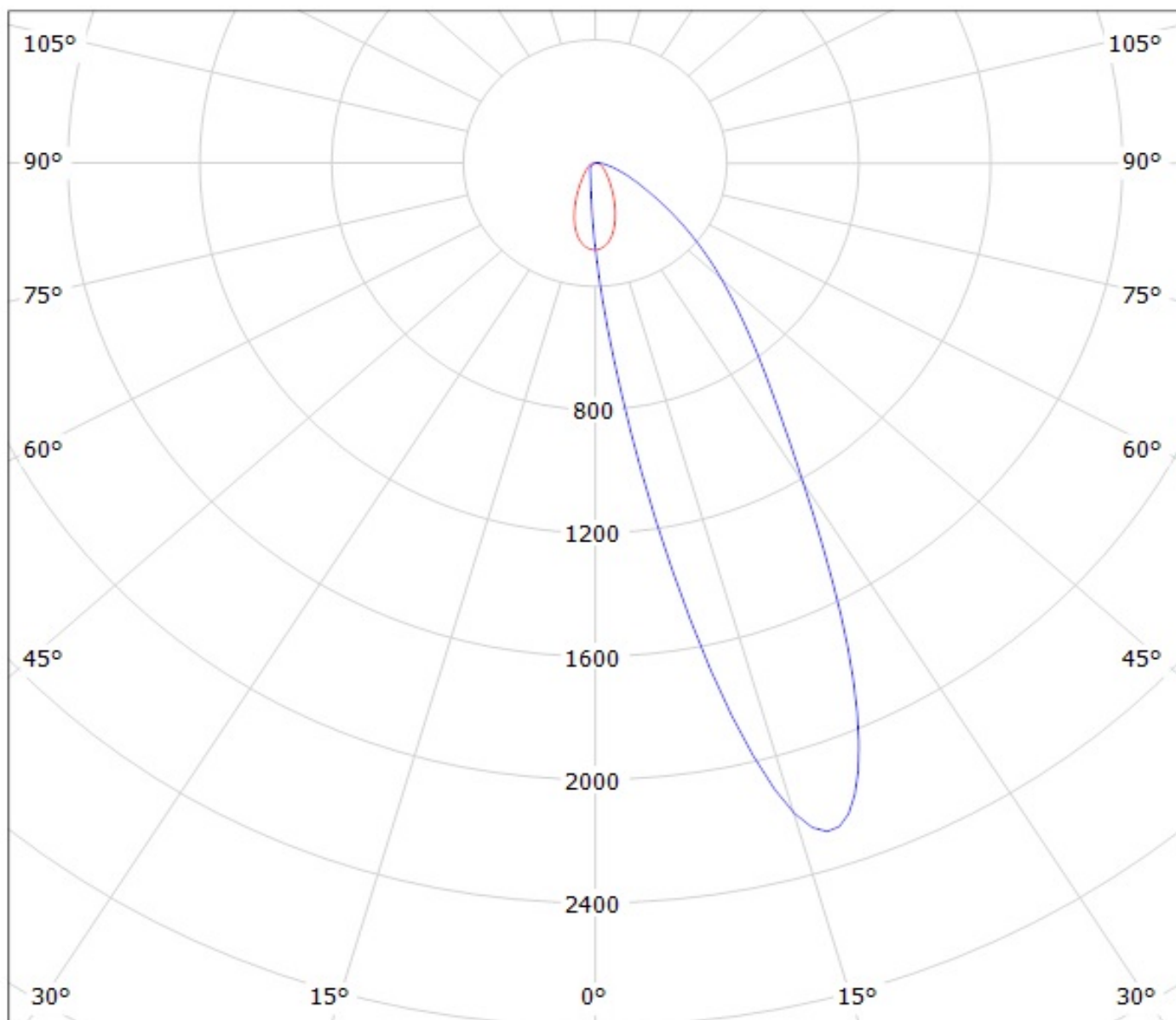

cd/klm

— C0 - C180

— C90 - C270

$\eta = 94\%$

Luminaire: Ledil FCA14295_BILLIE-B_(LH315B)

Lamps: 1 x Samsung_LH315B_110.075lm@250mA_P=0.7275W_I=0.25A

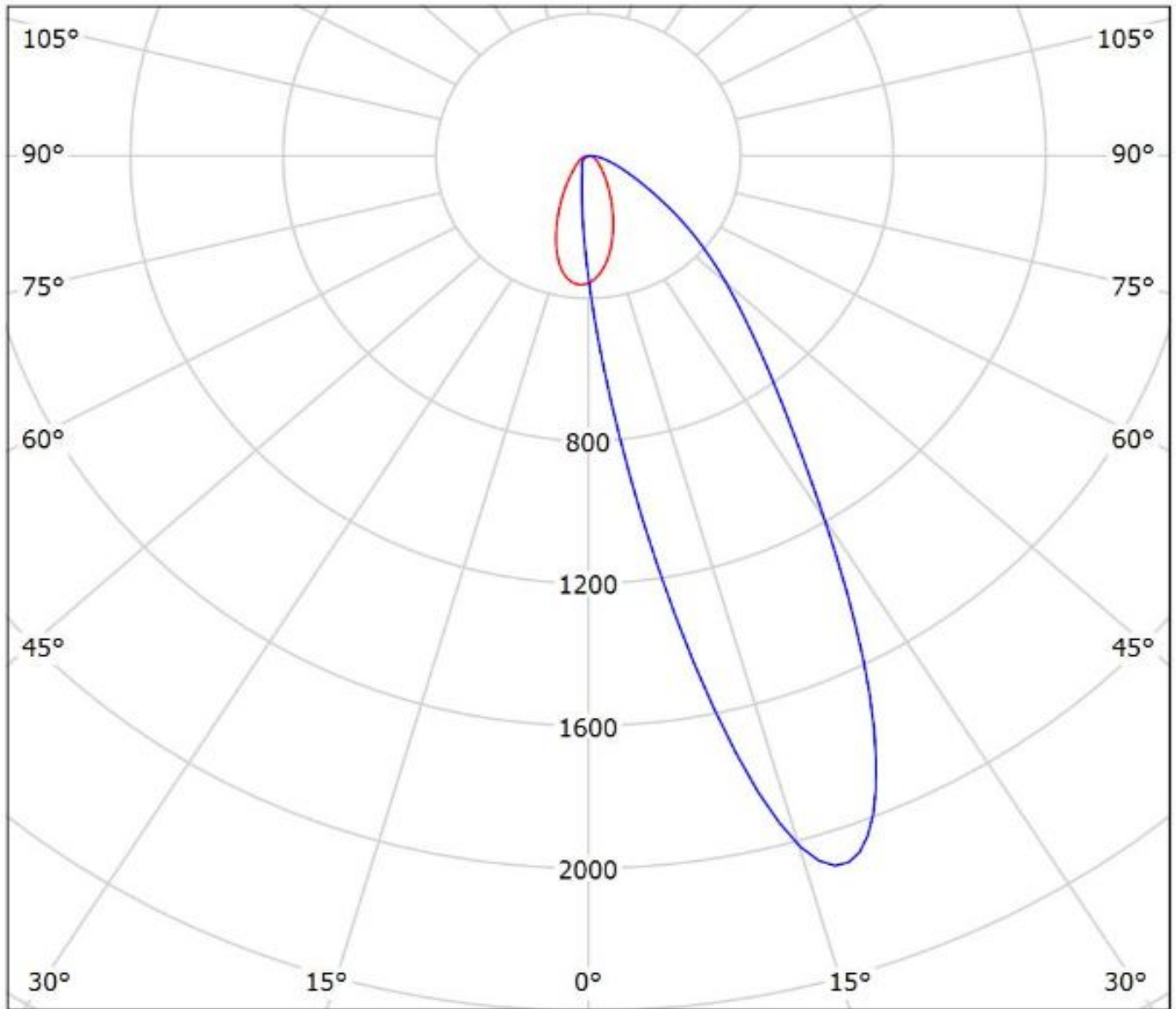

cd/klm

— C0 - C180 — C90 - C270

$\eta = 93\%$

Luminaire: LEDiL Oy FCA14295_BILLIE-B_(Z5M1)

Lamps: 1 x Seoul_Z5M1_(SZ5-M1-W0-C8)_111.713lm@250mA_P=0.745402W_I=0.2499A

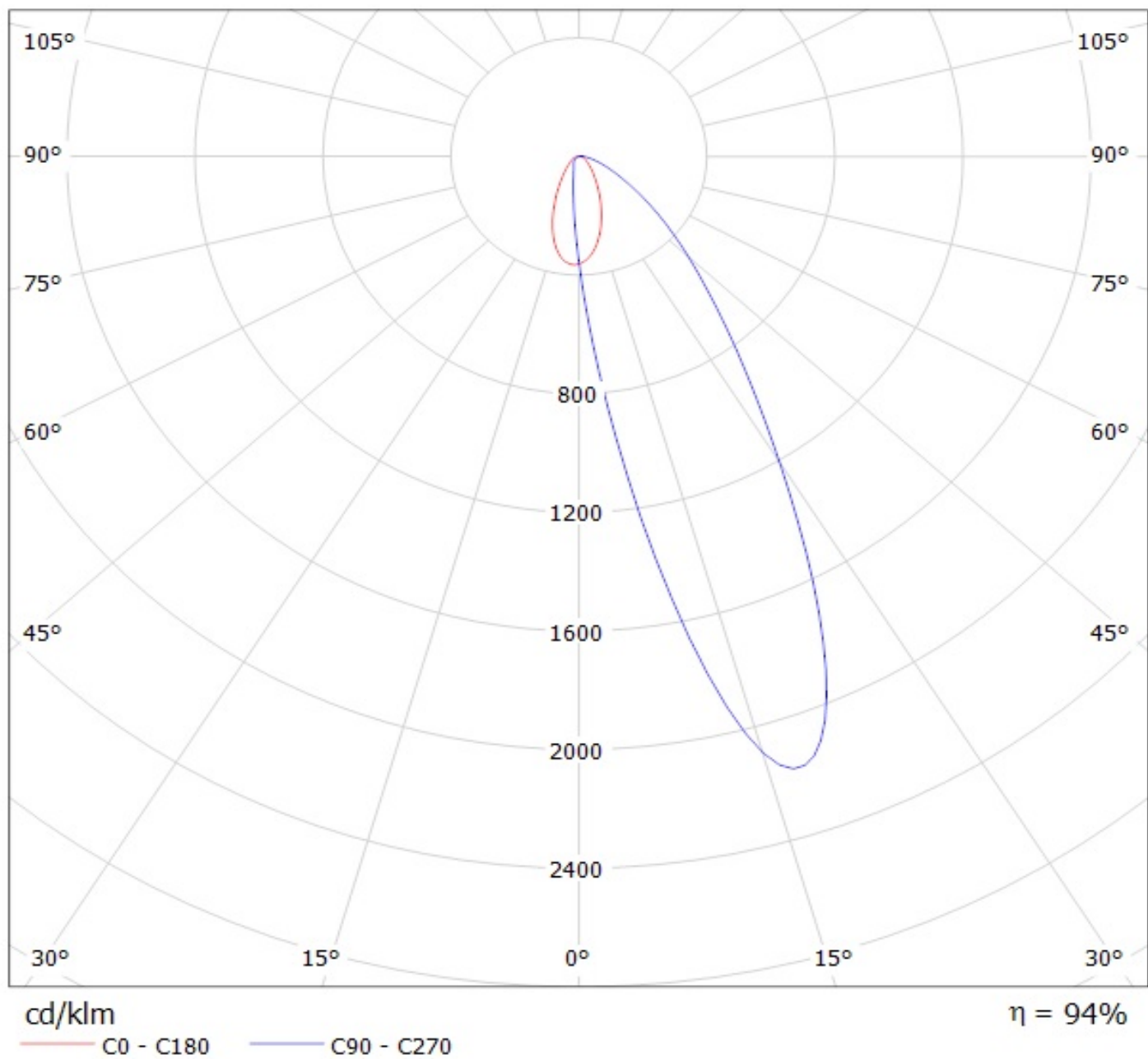

NOTE: The typical divergence will be changed by different color, chip size and chip position tolerance. The typical total divergence is the full angle measured where the luminous intensity is half of the peak value.