

Small-sized Class-D Speaker Amplifiers

Analog Input

Stereo Class-D Speaker Amplifier

BD5471MUV

No.13101EBT03

●Description

BD5471MUV is a low voltage drive class-D stereo speaker amplifier that was developed for note-book PC, cellular phone, mobile audio products and the others. LC filters of speaker outputs are unnecessary, and only 7 external components are needed for speaker system. Also, 3.3V regulator in BD5471MUV can use power supply for audio-codec. BD5471MUV, that is high-efficiency, low consumption, is suitable for application by using battery. Shutdown current is 0μA typically. Also, start-up time is fast from shutdown to active mode. BD5471MUV can use for some applications that change mode between "shutdown state" and "active state".

●Features

- 1) High power 2.3W typ. (VDD=5V, RL=4Ω, THD+N=10%, stereo input)
High power 1.5W typ. (VDD=5V, RL=8Ω, THD+N=10%, stereo input)
- 2) Gain selectable by the external control (6, 12, 18, 24dB)
- 3) Pop noise suppression circuitry
- 4) Standby function (Mute function) [I_{SD}=0uA]
- 5) Protection circuitry (Short protection [Audio, REG], Thermal shutdown, Under voltage lockout)
- 6) Built-in 3.3V regulator
- 7) Built-in BEEP detect circuitry
- 8) Very small package VQFN024V4040

●Applications

Notebook computers, Mobile electronic applications, Mobile phones, PDA etc.

●Absolute Maximum Ratings(Ta=+25°C)

Parameter	Symbol	Ratings	Unit
Power Supply Voltage	VDD	7.0	V
Power Dissipation	Pd	0.7 *1	W
		2.2 *2	W
Storage Temperature Range	Tstg	-55 ~ +150	°C
Input Voltage Range *3	Vin	-0.3 ~ VDD+0.3	V
Control Terminal Input Voltage Range *4	Vctl	-0.3 ~ VDD+0.3	V

*1 74.2mm × 74.2mm × 1.6mm, FR4 1-layer glass epoxy board(Copper on top layer 0%)

Derating in done at 5.6mW/°C for operating above Ta=25°C. There are thermal via on the board

*2 4.2mm × 74.2mm × 1.6mm, FR4 4-layer glass epoxy board (Copper on bottom 2 and 3 layer 100%)

*3 input Terminal (INL+, INL-, INR+, INR-)

*4 Control Terminal (MUTE, G0, G1, EAPD, BEEP, REG_SD)

●Operating Conditions

Parameter	Symbol	Ratings	Unit
Power Supply Voltage	VDD	+4.5 ~ +5.5	V
Temperature Range	Topr	-40 ~ +85	°C

* These products aren't designed for protection against radioactive rays.

●Electric Characteristics(Unless otherwise specified, Ta=+25°C, VDD=+5.0V, RL=8Ω, AC item= LC Filter(L=22μH, C=1μF))

Parameter	Symbol	Limits			Unit	Conditions
		MIN.	TYP.	MAX.		
Circuit current (Active)	I _{CC}	—	5.5	12.0	mA	Active mode, MUTE=H, EAPD=H, No load
Circuit current (Standby)	I _{STBY}	—	0.1	1.0	mA	Standby mode, MUTE=H, EAPD=L
Circuit current (Regulator)	I _{CCR}	—	0.15	1.0	mA	Regulator Mode, MUTE=EAPD=L, REG_SD=H
Circuit current (Shutdown)	I _{SD}	—	0.1	2.0	μA	Shutdown mode, MUTE=L, REG_SD=L
<Speaker Amplifier>						
Output power 1	P _{O1}	0.8	1.2	—	W	BTL, f=1kHz, THD+N=1%, Stereo input, *1, *2
Output power 2	P _{O2}	1.0	1.5	—	W	BTL, f=1kHz, THD+N=10%, Stereo input, *1, *2
Voltage gain	GV	5.5	6.0	6.5	dB	BTL, G0=G1=GND
		11.5	12	12.5	dB	BTL, G0=GND, G1=VDD
		17.5	18	18.5	dB	BTL, G0=VDD, G1=GND
		23.5	24	24.5	dB	BTL, G0=G1=VDD
Total harmonic distortion	THD+N	—	0.2	1.0	%	BTL, Po=0.7*P _{O1} *1, *2
Crosstalk	C _T	60	70	—	dB	BTL, f=1kHz *1, *3
S/N	SNR	70	90	—	dB	BTL, Po=P _{O1} *1, *3
Switching Frequency	f _{osc}	175	250	325	kHz	
Start-up time	T _{on}	0.78	1.02	1.46	msec	
Input resistance	R _{IN}	63	90	117	kΩ	G0=G1=GND
		42	60	78	kΩ	G0=GND, G1=VDD
		25	36	47	kΩ	G0=VDD, G1=GND
		14	20	26	kΩ	G0=G1=VDD
<Regulator>						
Output voltage	V _o	3.15	3.30	3.45	V	I _o =150mA
Maximum output current	I _{om}	150	200	—	mA	V _o =3.15V
Load regulation	L _{REG}	—	0.2	1	mV/mA	I _o =0→150mA
<Control terminal (MUTE, G0, G1, EAPD, BEEP, REG_SD) >						
Control terminal input voltage	High-level	V _{CTLH}	1.4	—	VDD	V
	Low-level	V _{CTL}	0	—	0.4	V
Control terminal input current	I _{CTL}	22	33	44	μA	Control terminal Input voltage V _{CTL} =5V

*1: B.W. =400 ~ 30kHz, BTL: The voltage between 3pin and 6pin, 13pin and 16pin

●Active / Standby Control

Mode	Pin level	Conditions
MUTE	H/L	IC active/ shutdown
EAPD	H/L	IC active/standby
BEEP	H/L	IC active/standby
REG_SD	H/L	REG active/shutdown

● Measurement Circuit Diagram

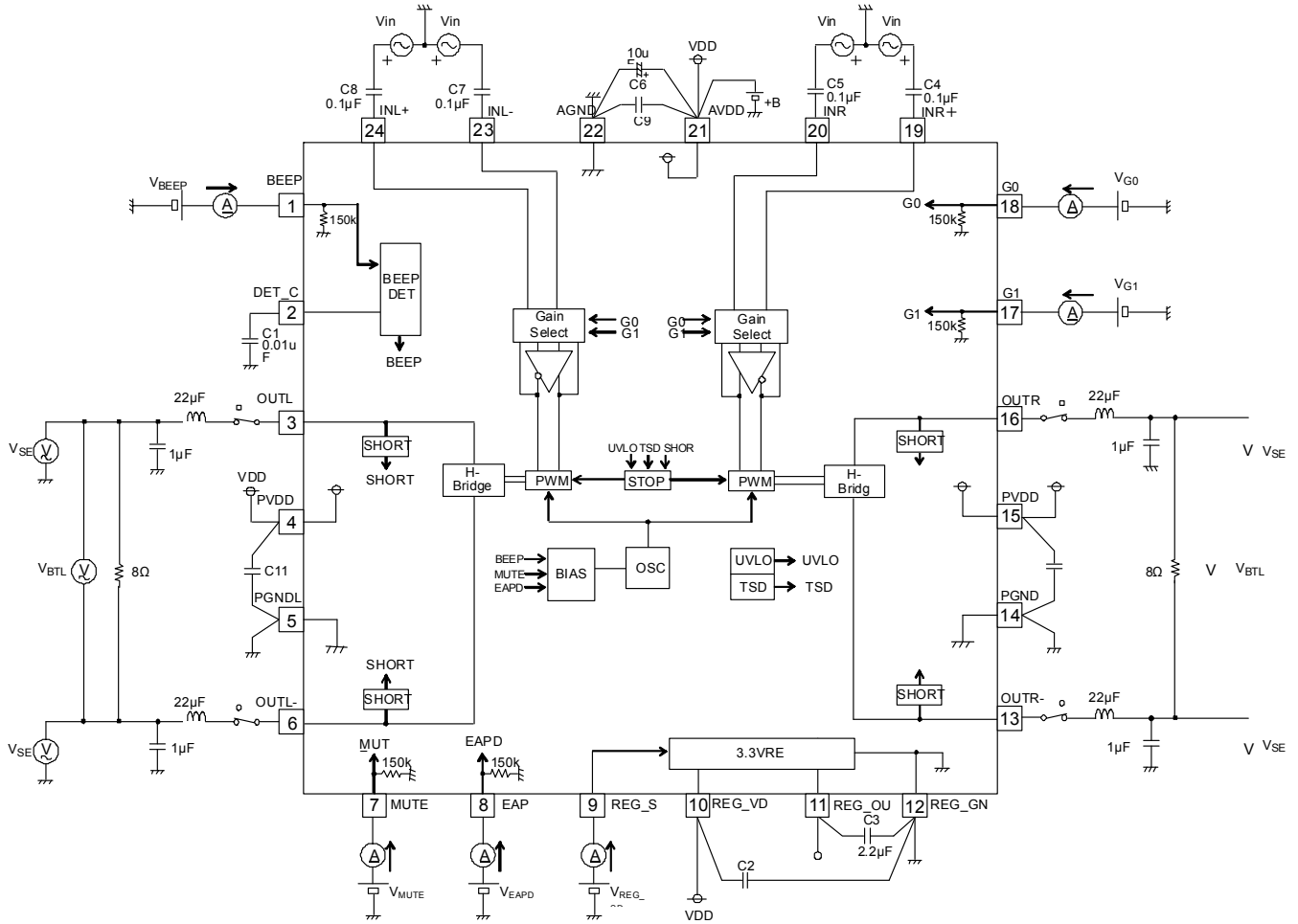

● Package Outlines

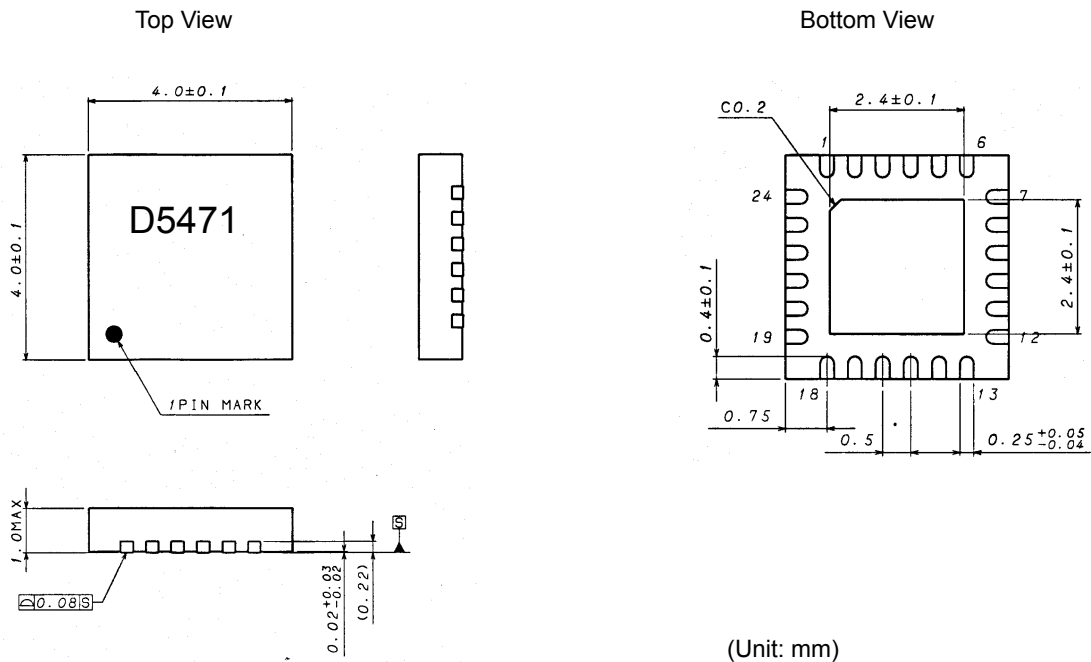

VQFN024V4040 (Plastic Mold)

●Block Diagram

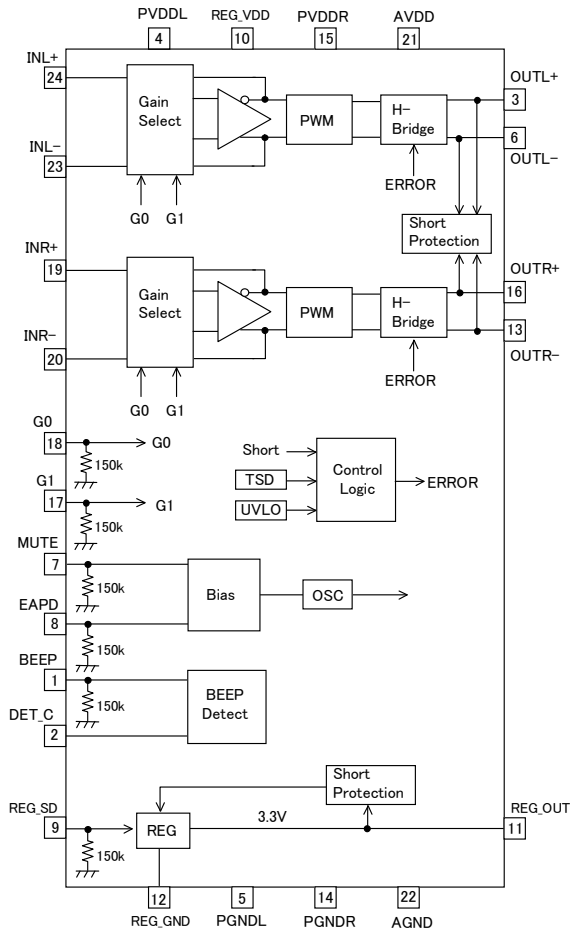

●Pin Assignment <top view>

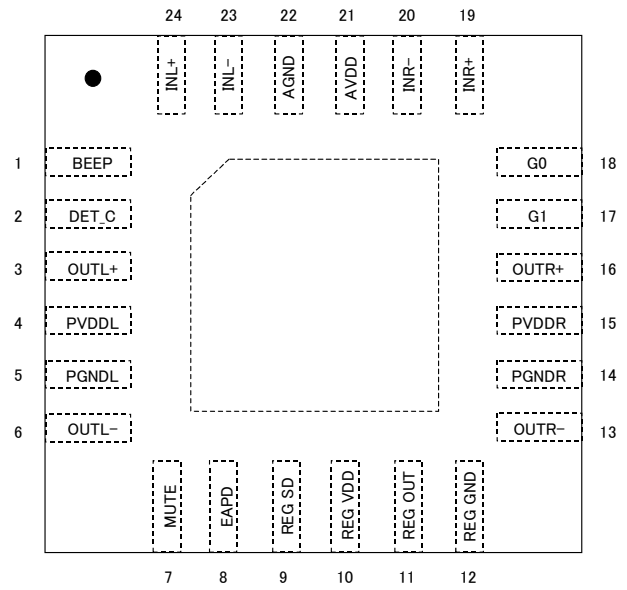

●Pin Assignment Table

PIN No.	PIN Name
1	BEEP
2	DET_C
3	OUTL+
4	PVDDL
5	PGNDL
6	OUTL-
7	MUTE
8	EAPD
9	REG_SD
10	REG_VDD
11	REG_OUT
12	REG_GND
13	OUTR-
14	PGNDR
15	PVDDR
16	OUTR+
17	G1
18	G0
19	INR+
20	INR-
21	AVDD
22	AGND
23	INL-
24	INL+

● Application Circuit Example

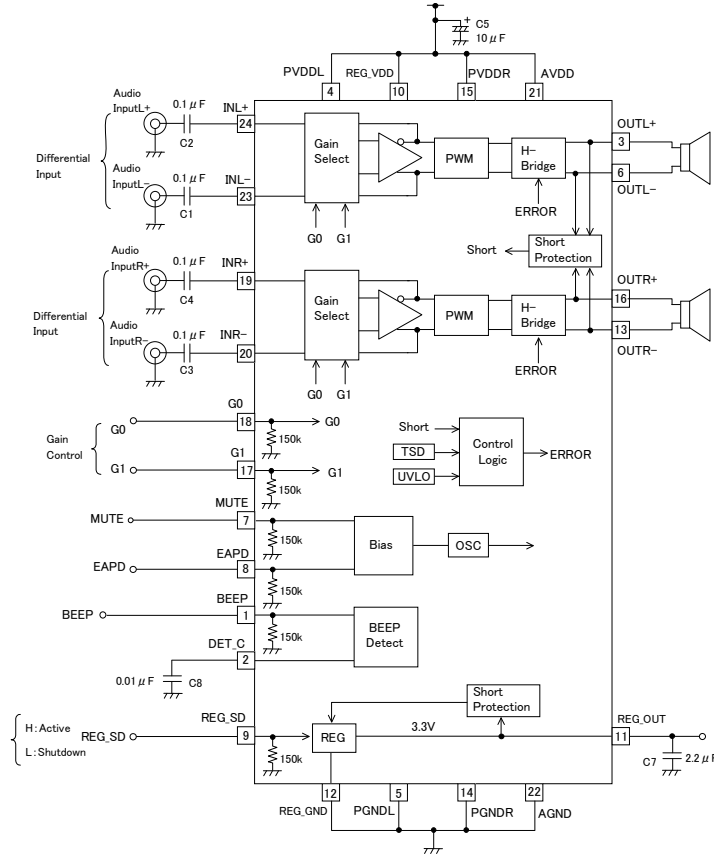

Differential input

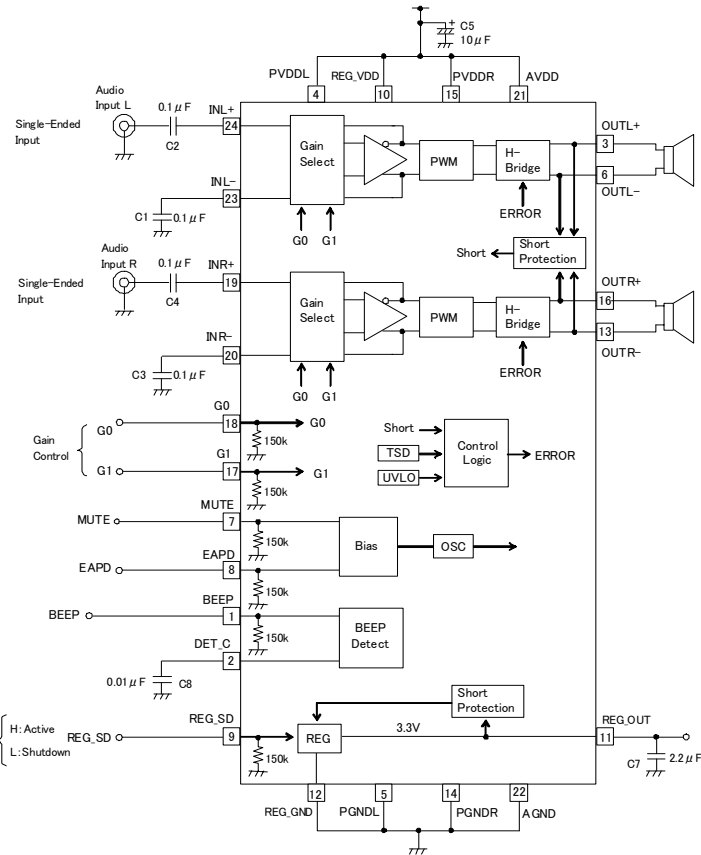

Single-Ended input

●Evaluation board Circuit Diagram

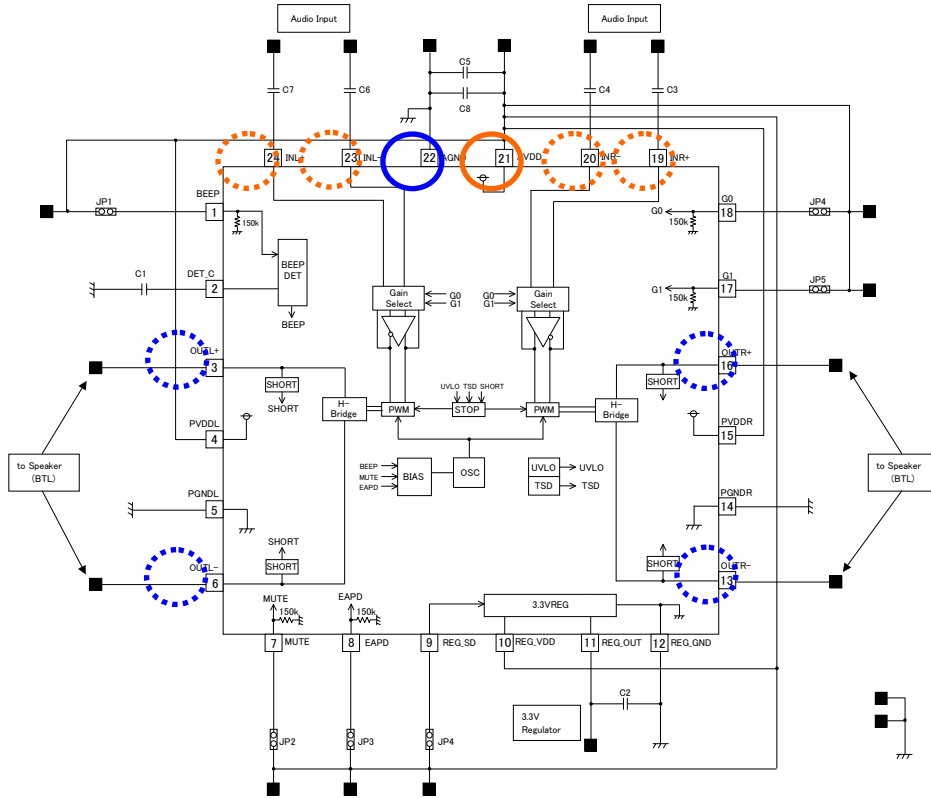

- Please connect to **Input Signal** line.
- Please connect to **Power Supply** (VDD=+4.5~5.5V) line.
- Please connect to **GND** line.

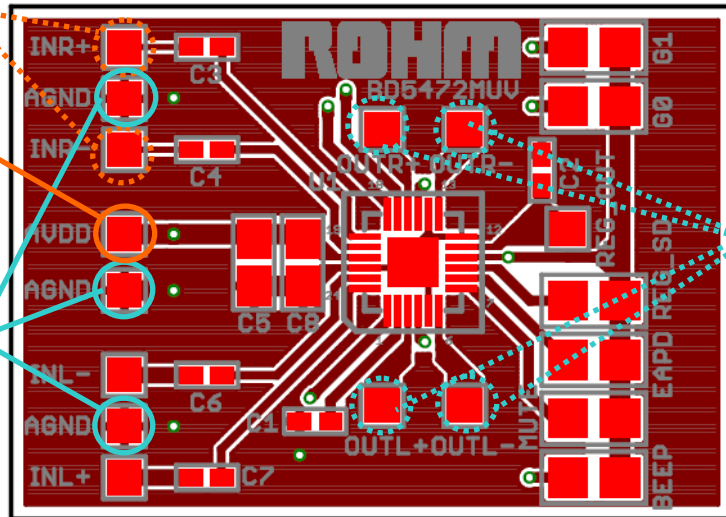

Please connect to **Speaker**.

●Evaluation board Parts List

Qty.	Item	Description	SMD Size	Manufacturer/Part Number
1	C1	Capacitor, 0.01μF	1608	Murata GRM188R71C103KA01D
1	C2	Capacitor, 2.2μF	1608	Murata GRM188R61C225KE15D
2	C3, C4,C6,C7	Capacitor, 0.1μF	1608	Murata GRM188R71C104KA01D
1	C5, C8	Capacitor, 10μF	A (3216)	ROHM TCFGA1A106M8R
1	U1	IC, BD5471MUV, Stereo Class-D audio amplifier	4.0mm X 4.0mm VQFN Package	ROHM BD5471MUV
1	PCB1	Printed-circuit board, BD5471MUV EVM	—	—

●The relation in the gain setting and input impedance Ri

The gain setting terminal (G0, G1)

G0	G1	Gain[dB]	Ri [Ohm]
L	L	6	90k
L	H	12	60k
H	L	18	36k
H	H	24	20k

●Description of External parts

①Power down timing capacitor (C1)

It's the capacitor which adjusts time from BEEP signal stop to amplifier stop.
Turn off time T_{off} is set the following formula.

$$T_{off} = \frac{C1 \times 0.8V_{DD}}{5\mu} [\text{ms}]$$

②Regulator output capacitor(C2)

Output capacitor of 3.3V regulator.
Use capacitance equal to or more than 1μF.

③Input coupling capacitor Ci (C3,C4, C6,C7)

It makes an Input coupling capacitor 0.1μF.
Input impedance Ri in each gain setting becomes the above table.
In 18dB gain setting, it is Ri=36kΩ (Typ.).

It sets cutoff frequency f_c by the following formula by input coupling capacitor Ci (C3,C4, C6,C7) and input impedance Ri

$$f_c = \frac{1}{2\pi \times Ri \times Ci} [\text{Hz}]$$

In case of Ri=36kΩ, Ci=0.1μF, it becomes f_c =about 44Hz.

④The power decoupling capacitor (C5,C8)

It makes a power decoupling capacitor 10μF.
When making capacitance of the power decoupling capacitor small, there is an influence in the Audio characteristic.
When making small, careful for the Audio characteristic at the actual application.

●Evaluation board PCB layer

Top Layer

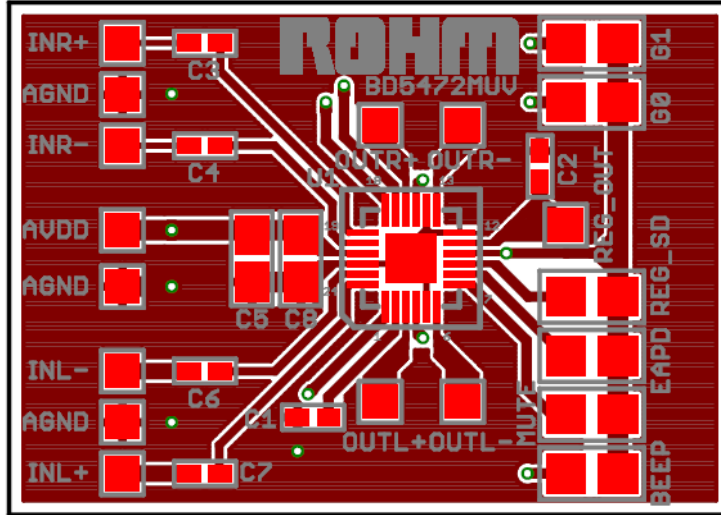

Bottom Layer

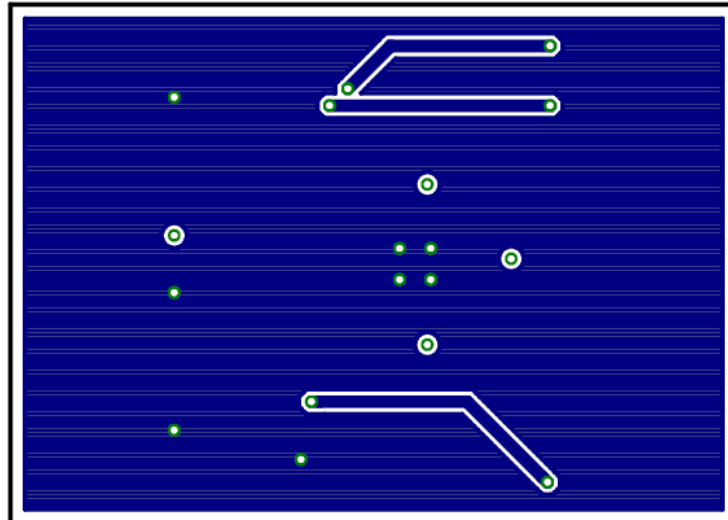

●The way of evaluating Audio characteristics

Evaluation Circuit Diagram

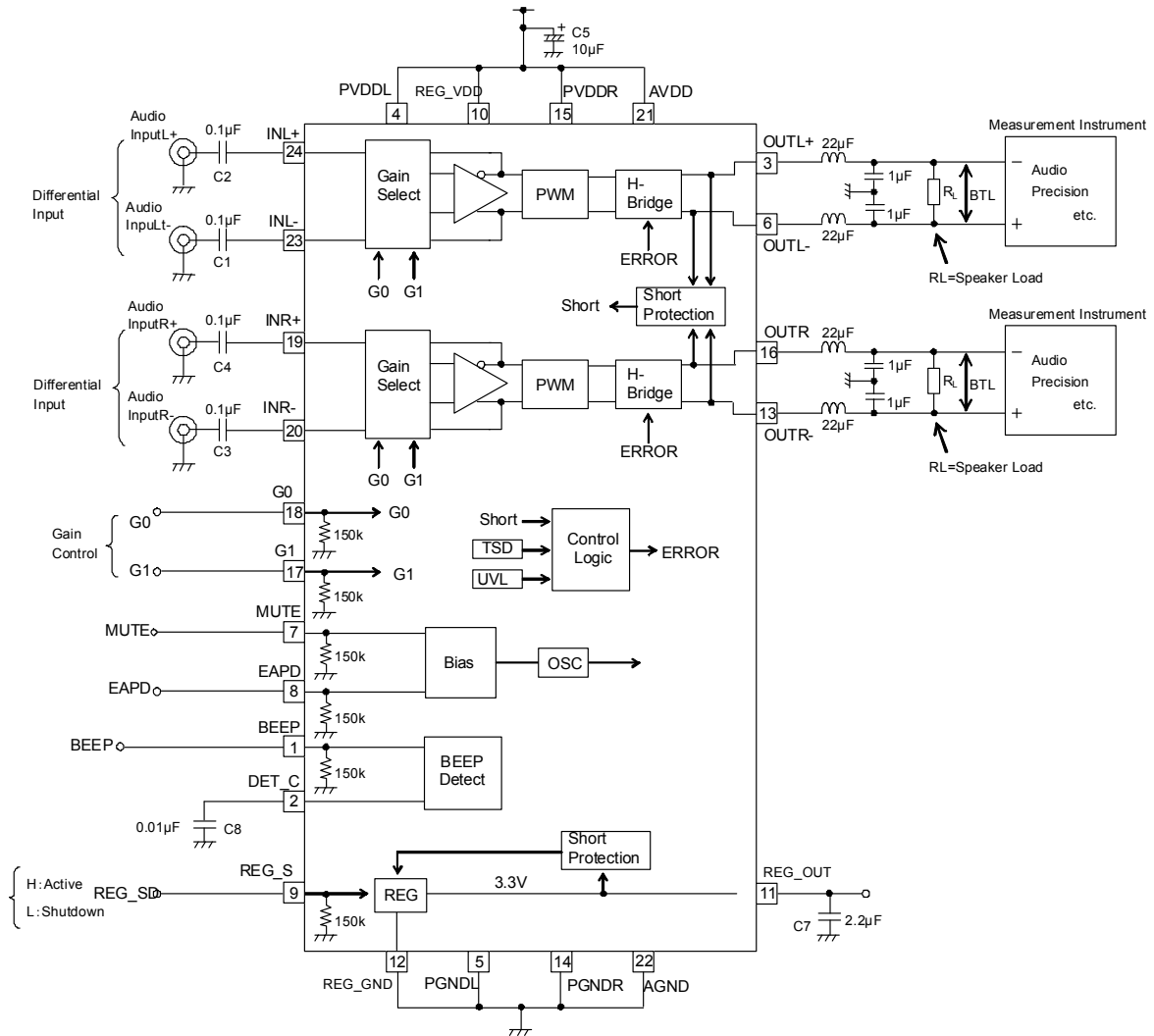

When measuring Audio characteristics, insert LC filter during the output terminal of IC and the speaker load and measure it. Arrange LC filter as close as possible to the output terminal of IC.
 In case of L=22 µ H, C=1 µ F, the cutoff frequency becomes the following.

$$f_c = \frac{1}{2\pi\sqrt{LC}} \text{ [Hz]}$$

$$=33.9\text{[kHz]}$$

Use a big current type - Inductor L.

(Reference)

TDK: SLF12575T-220M4R0

●BEEP Detection Function

This IC has BEEP detection.

When inputting beep signal to 1pin BEEP terminal at standby mode, amplifier becomes standby to active.

When beep signal stops, amplifier becomes active to standby.

It is adjustable the time(Toff) from beep signal stop to amplifier standby by a capacitance connect to 2pin DET_C terminal.
If no need to use BEEP detection, make 1pin BEEP terminal open or connect to GND.

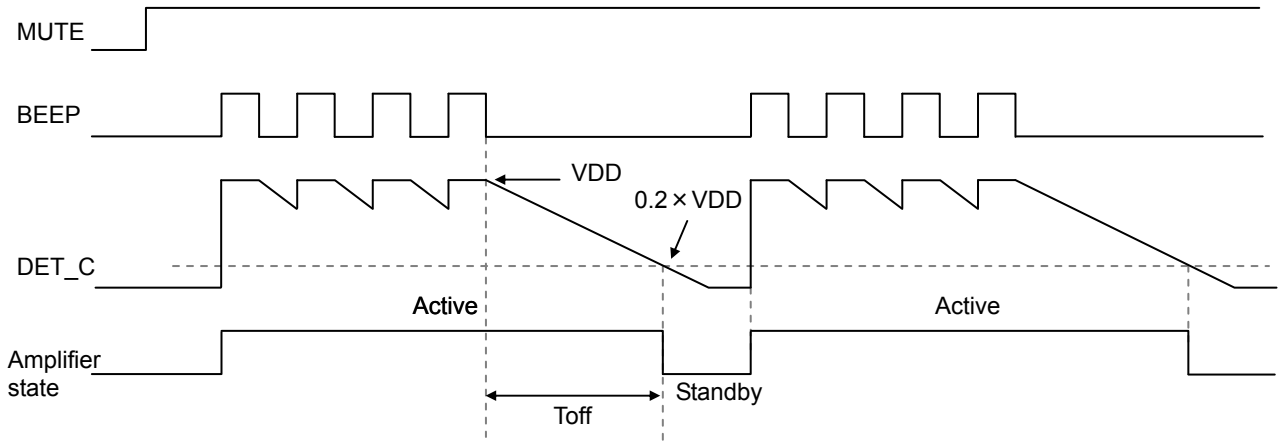

Toff calculation fomula

$$\text{Toff} = \frac{C \times 0.8VDD}{5\mu} \quad [\text{msec}]$$

Example C=0.01μ, VDD=5V → Toff=8msec

C: Condenser to connect to a 2pin

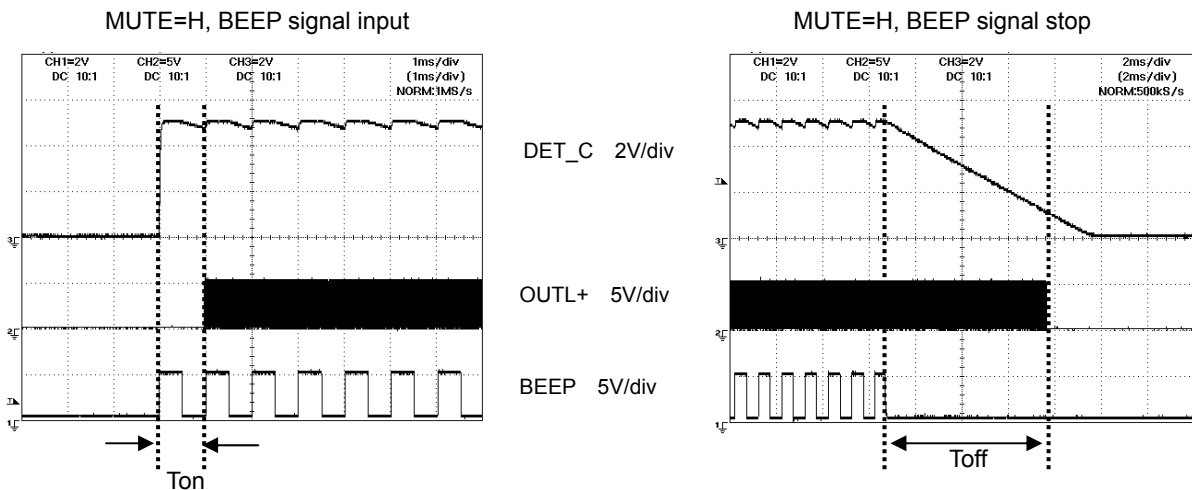

●Control Terminal and output

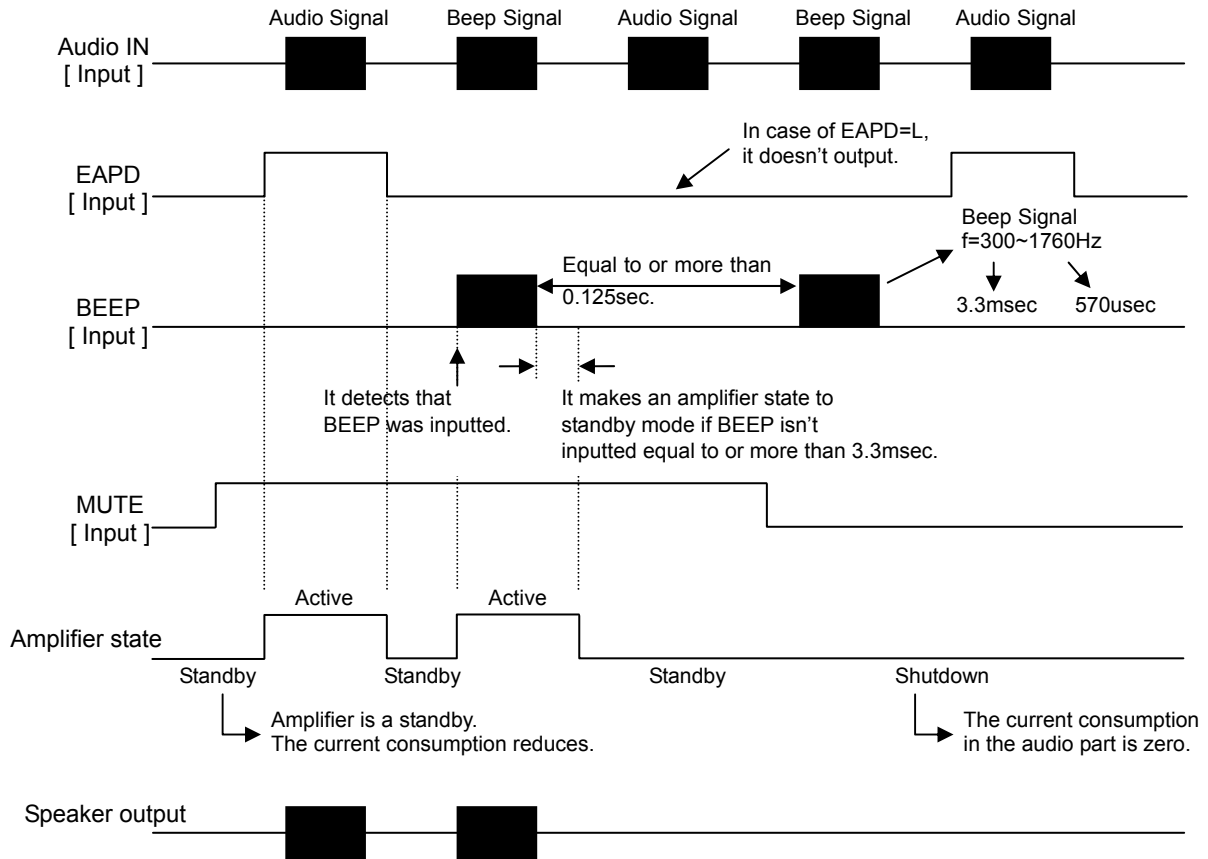

Input				Output	
MUTE	EAPD	BEEP	Audio IN	Amplifier state	Speaker output
L	L	L	No signal	L(Shutdown)	Hiz
L	L	L	signal	L(Shutdown)	Hiz
L	L	H	No signal	L(Shutdown)	Hiz
L	L	H	signal	L(Shutdown)	Hiz
L	H	L	No signal	L(Shutdown)	Hiz
L	H	L	signal	L(Shutdown)	Hiz
L	H	H	No signal	L(Shutdown)	Hiz
L	H	H	signal	L(Shutdown)	Hiz
H	L	L	No signal	L(Standby)	Hiz
H	L	L	signal	L(Standby)	Hiz
H	L	H	No signal	H(Active)	No signal
H	L	H	signal	H(Active)	signal
H	H	L	No signal	H(Active)	No signal
H	H	L	signal	H(Active)	signal
H	H	H	No signal	H(Active)	No signal
H	H	H	signal	H(Active)	signal

●About output starting and stop

This IC has the circuit of pop noise reduction at starting and stop.
 Pop noise reduction is realized in controlling to adjust the timing of output at starting and stop.
 Turn on time is 1msec.

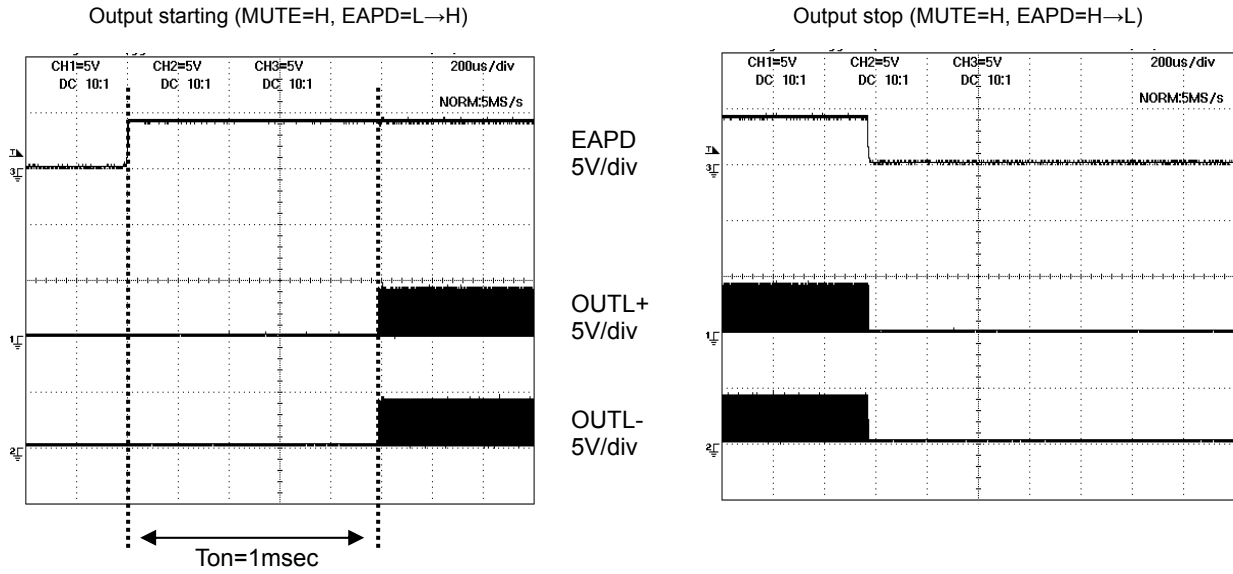

●About the short protection

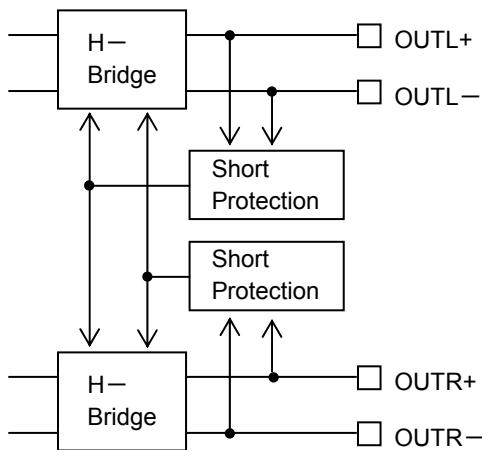

When detecting a short of Lch output, Lch output stops, and Rch output stops.
 Also when detecting a short of Rch output, Rch output stops, and Lch output stops.

●About the thermal design by the IC

Characteristics of an IC have a great deal to do with the temperature at which it is used, and exceeding absolute maximum ratings may degrade and destroy elements. Careful consideration must be given to the heat of the IC from the two standpoints of immediate damage and long-term reliability of operation. Pay attention to points such as the following. Since an maximum junction temperature ($T_{JMAX.}$) or operating temperature range (T_{opr}) is shown in the absolute maximum ratings of the IC, to reference the value, find it using the Pd-Ta characteristic (temperature derating curve). If an input signal is too great when there is insufficient radiation, TSD (thermal shutdown) may operate. TSD, which operates at a chip temperature of approximately +180°C, is canceled when this goes below approximately +100°C. Since TSD operates persistently with the purpose of preventing chip damage, be aware that long-term use in the vicinity that TSD affects decrease IC reliability.

Temperature Derating Curve

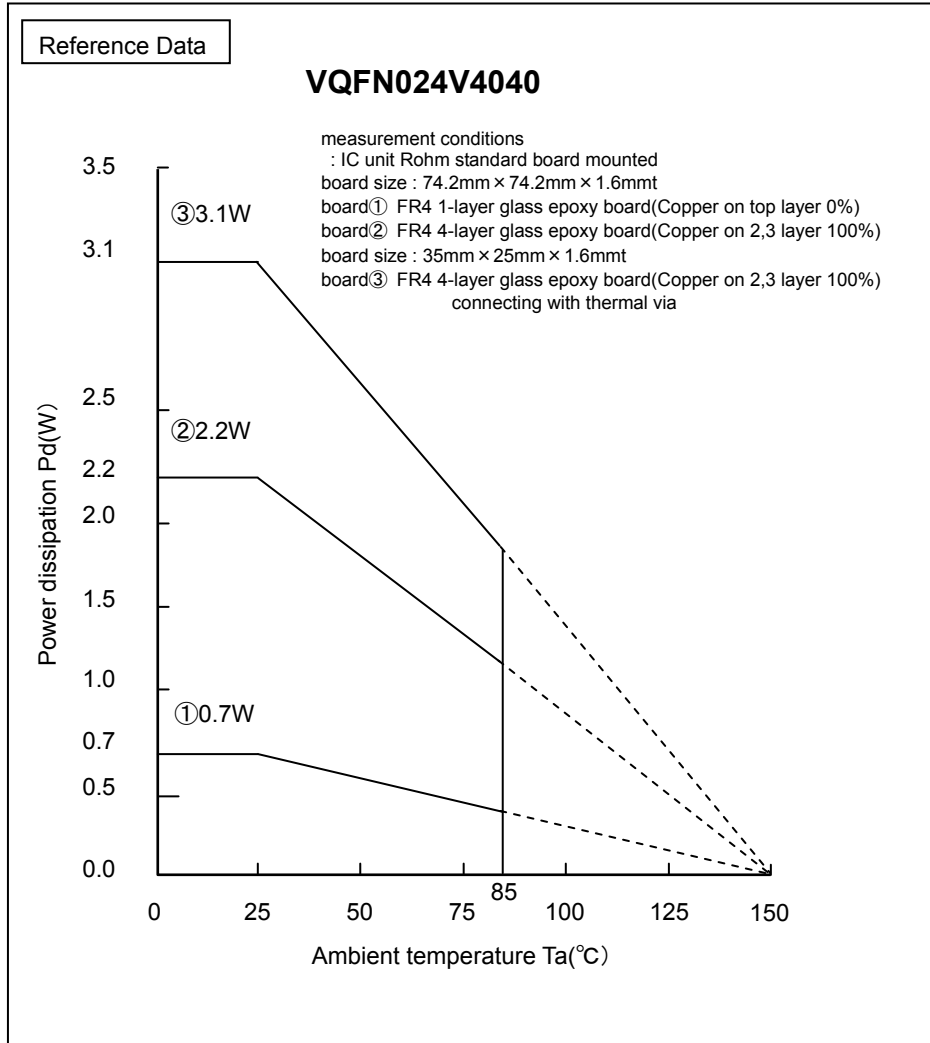

Note) Values are actual measurements and are not guaranteed.

Power dissipation values vary according to the board on which the IC is mounted. The Power dissipation of this IC when mounted on a multilayer board designed to radiate is greater than the values in the graph above.

● Typical Characteristics

TABLE OF GRAPHS

Parameter	Parameter	Figure
Efficiency	vs Output power	1, 2
Power dissipation	vs Output power	3, 4
Supply current (I _{ccact})	vs Supply voltage	5
Supply current (I _{stby})	vs Supply voltage	6
Supply current (I _{reg})	vs Supply voltage	7
Shutdown current (I _{sd})	vs Supply voltage	8
Output power (P _o)	vs Load resistance	9, 10
	vs Supply voltage	11, 12
Total harmonic distortion plus noise (THD+N)	vs Output power	13, 14
	vs Frequency	15, 16, 17, 18, 19, 20, 21, 22
	vs Common-mode input voltage	23, 24
Supply voltage rejection ratio (PSRR)	vs Frequency	25, 26, 27, 28
Common-mode rejection ratio (CMRR)	vs Frequency	29, 30
Gain	vs Frequency	31, 32, 33, 34, 35, 36, 37, 38

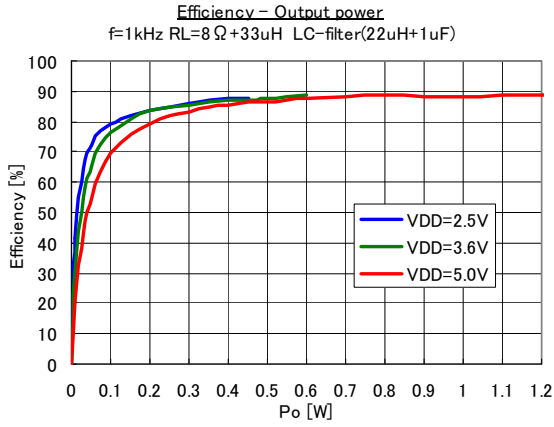

Fig.1

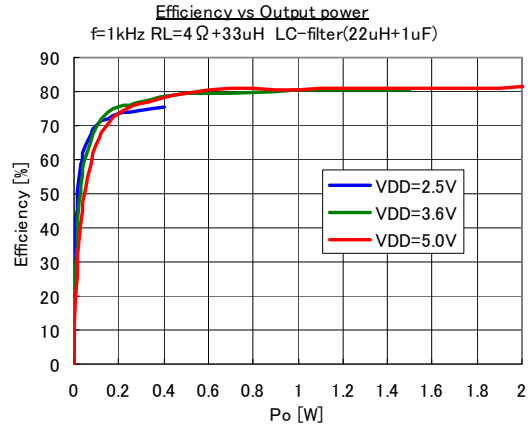

Fig.2

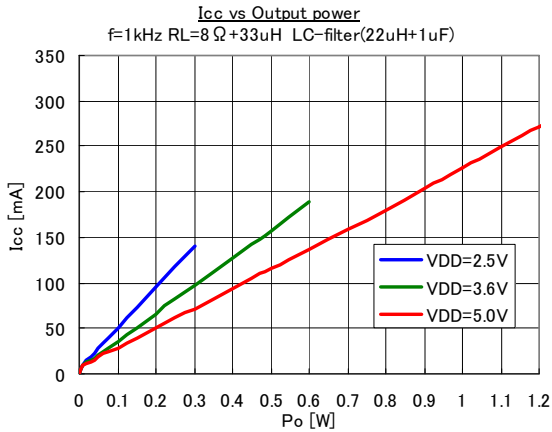

Fig.3

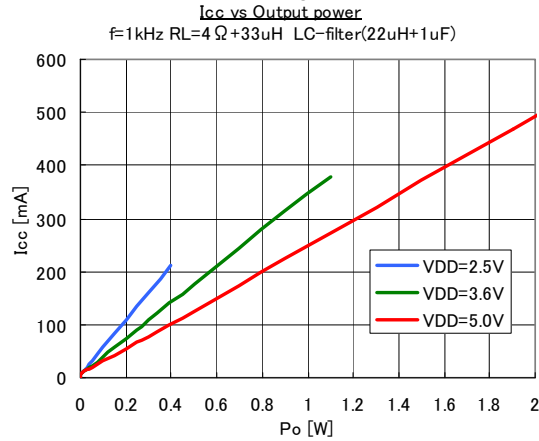

Fig.4

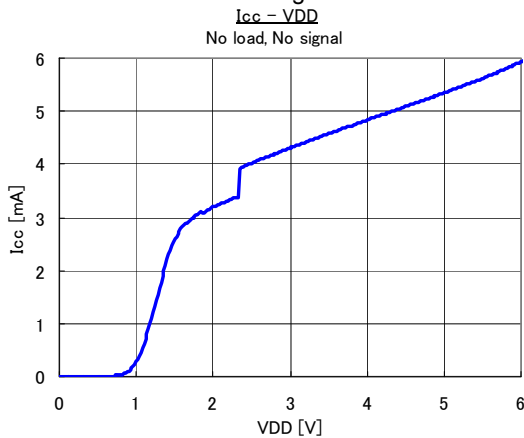

Fig.5

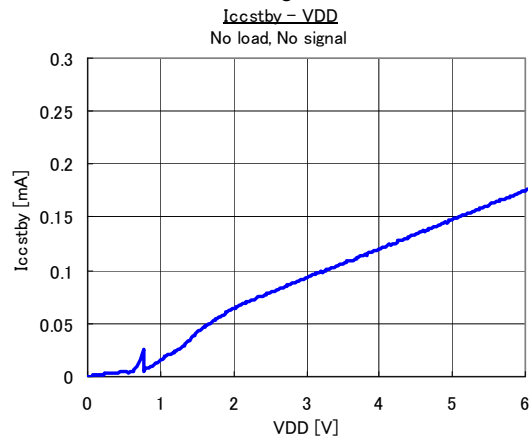

Fig.6

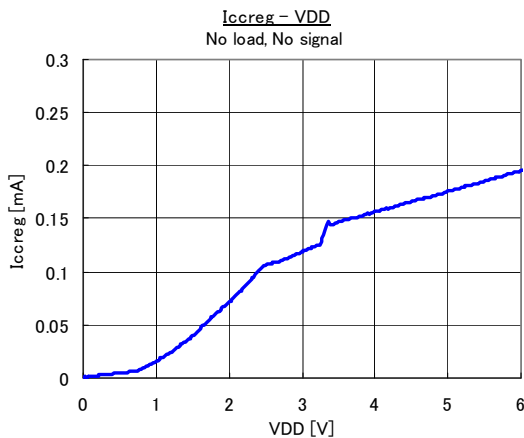

Fig.7

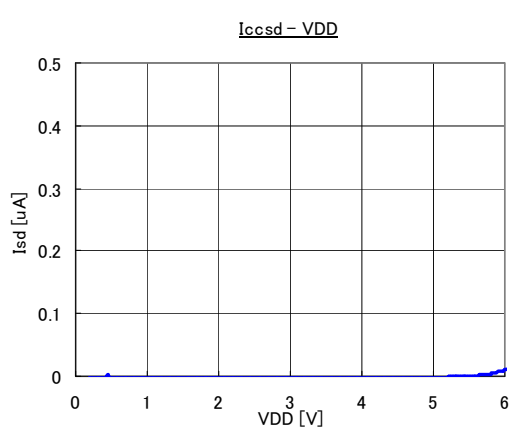

Fig.8

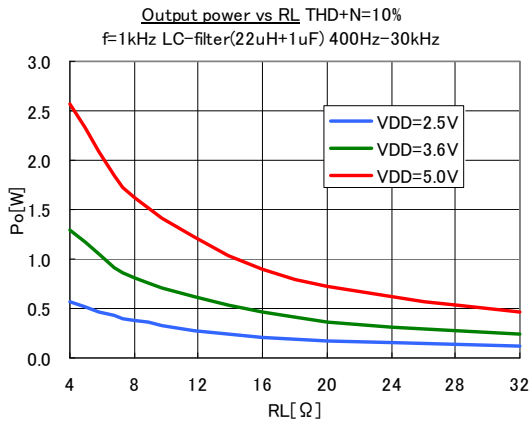

Fig.9

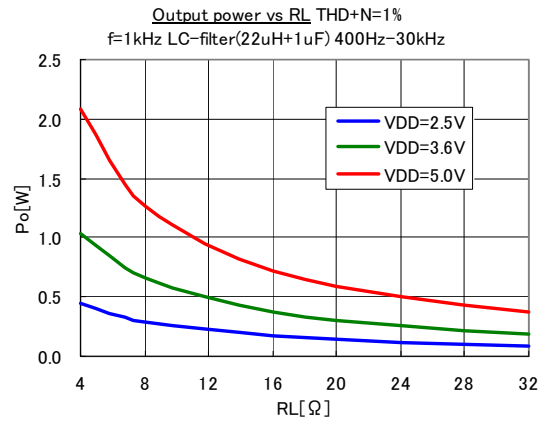

Fig.10

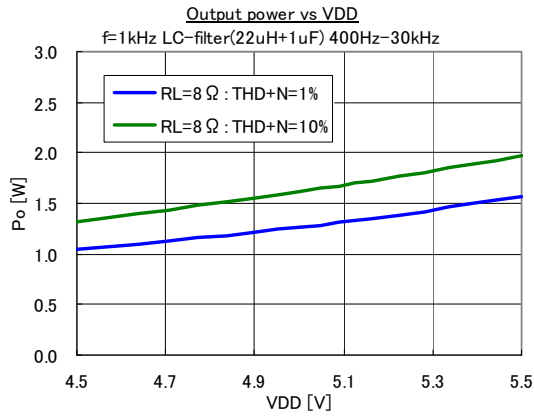

Fig.11

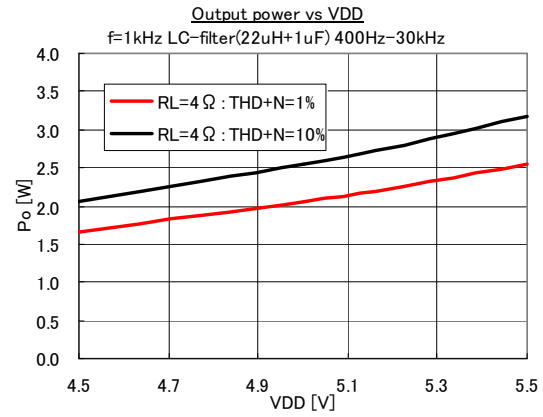

Fig.12

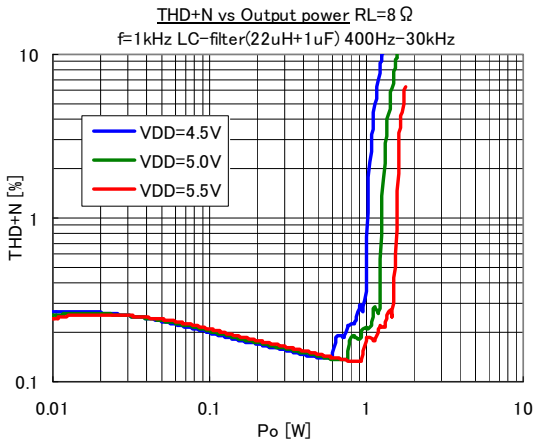

Fig.13

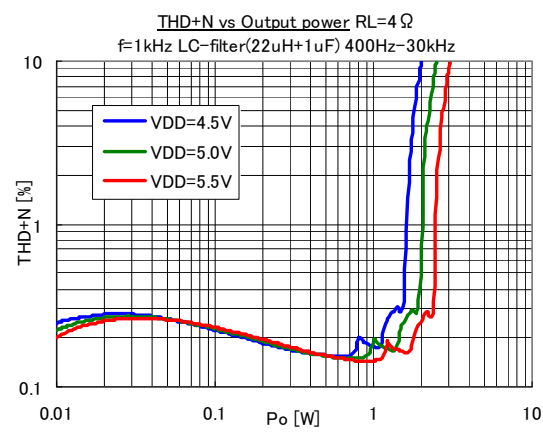

Fig.14

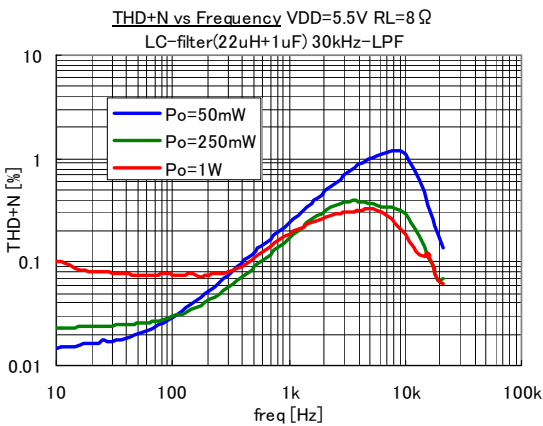

Fig.15

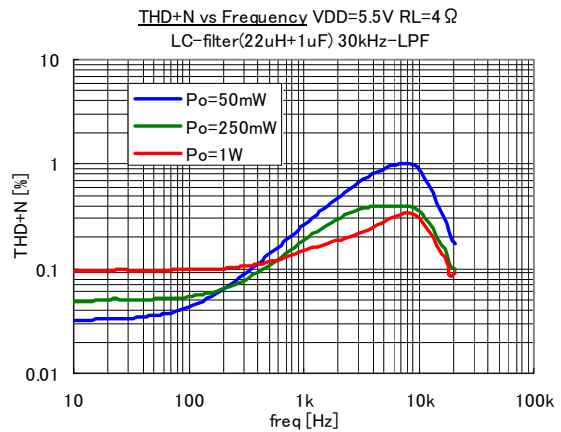

Fig.16

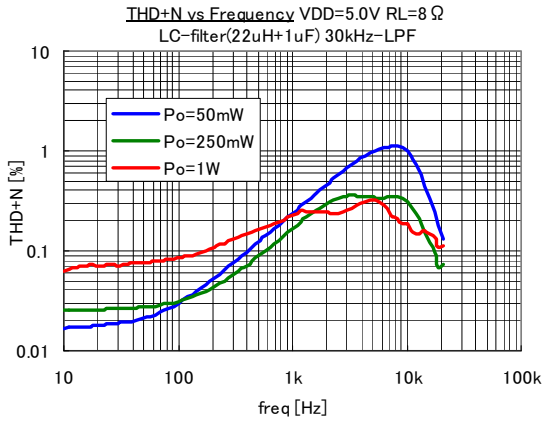

Fig. 17

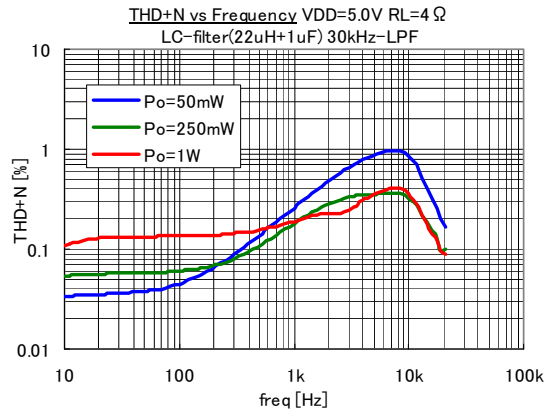

Fig. 18

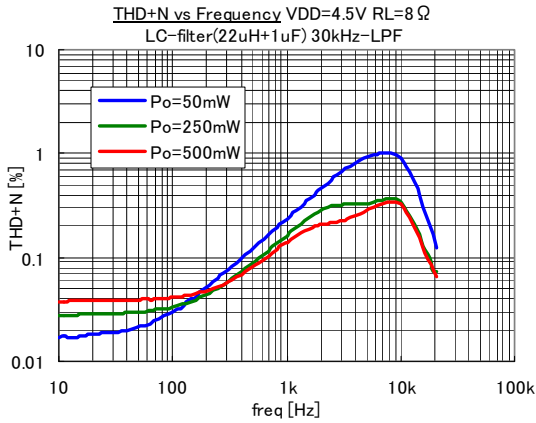

Fig. 19

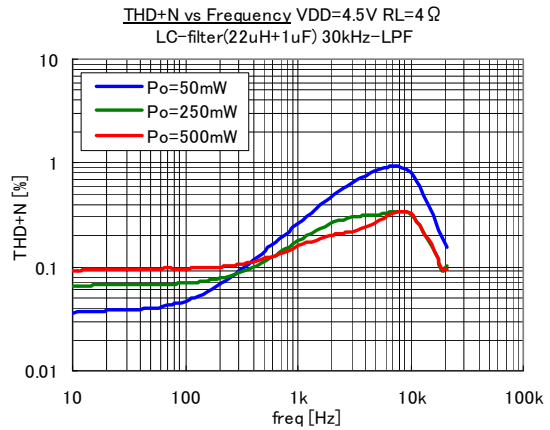

Fig. 20

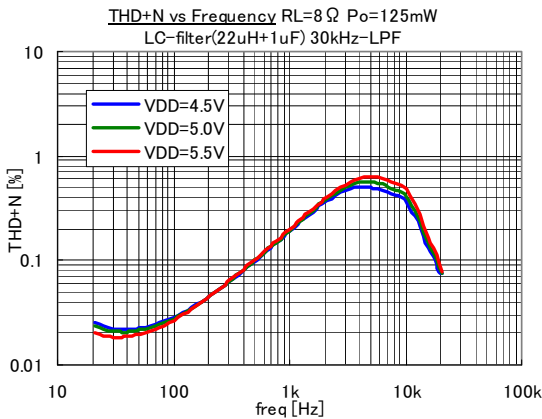

Fig. 21

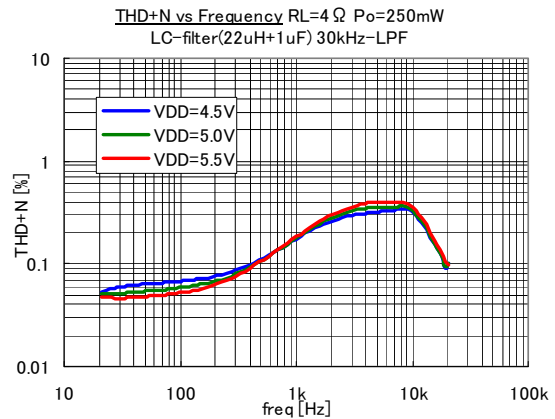

Fig. 22

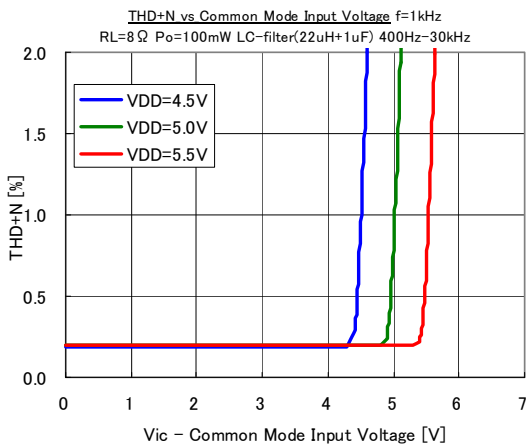

Fig. 23

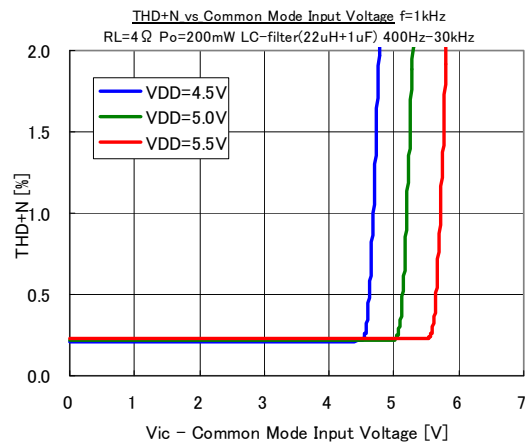

Fig. 24

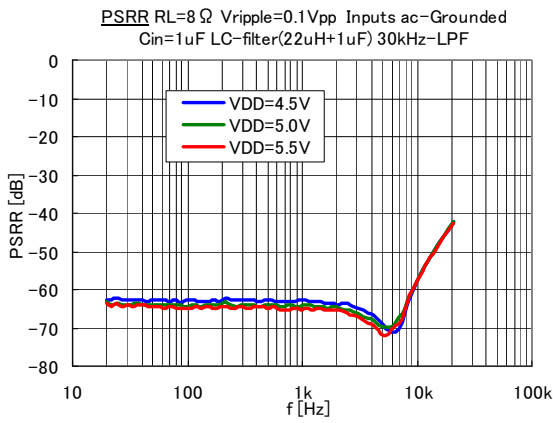

Fig.25

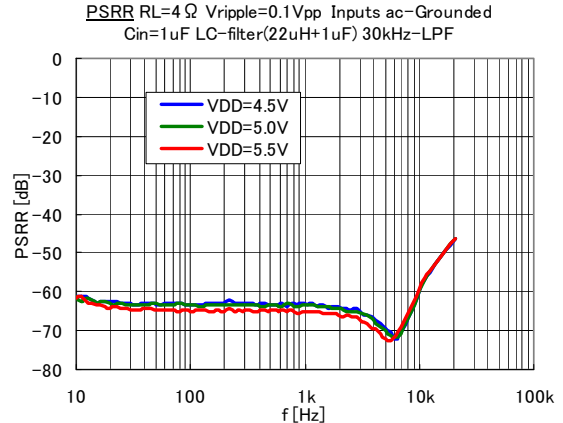

Fig.26

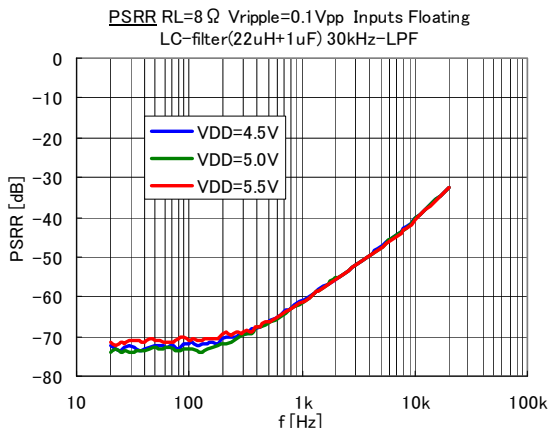

Fig.27

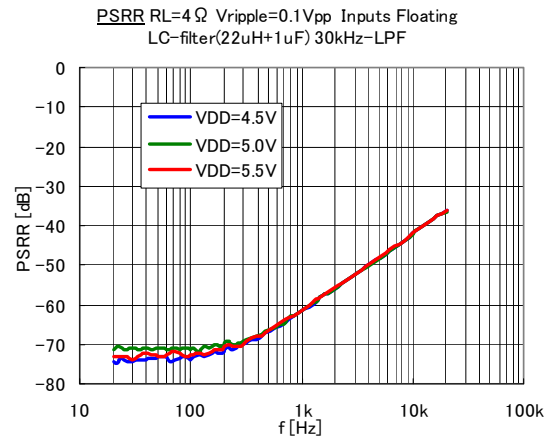

Fig.28

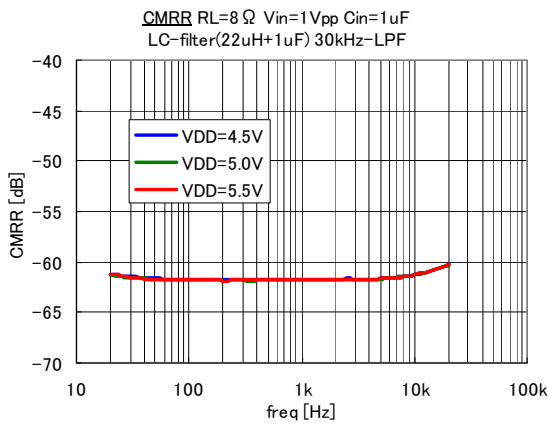

Fig.29

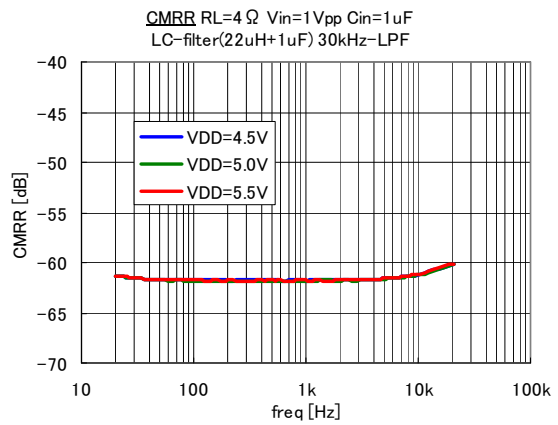

Fig.30

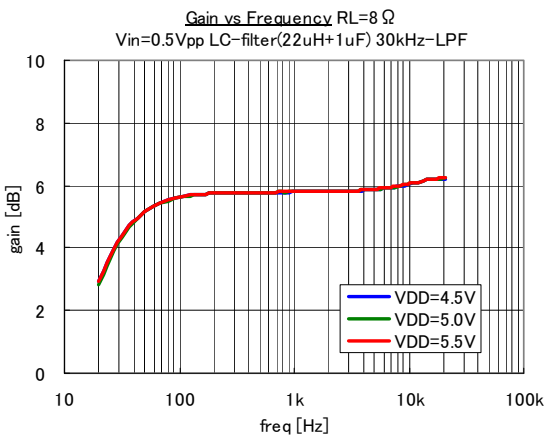

Fig.31

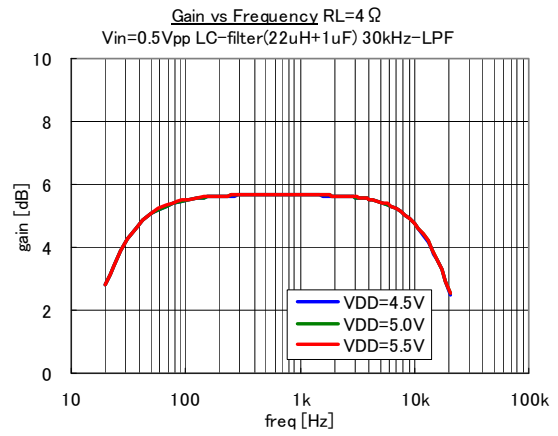

Fig.32

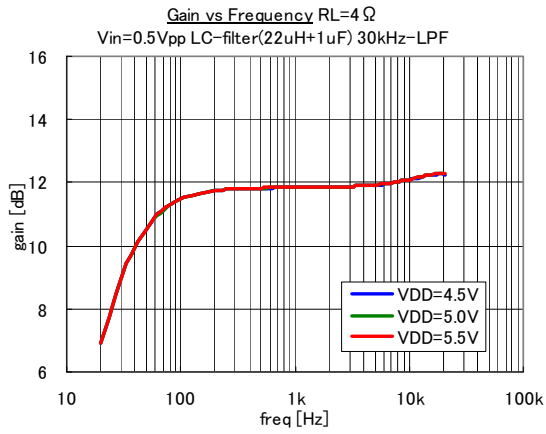

Fig.33

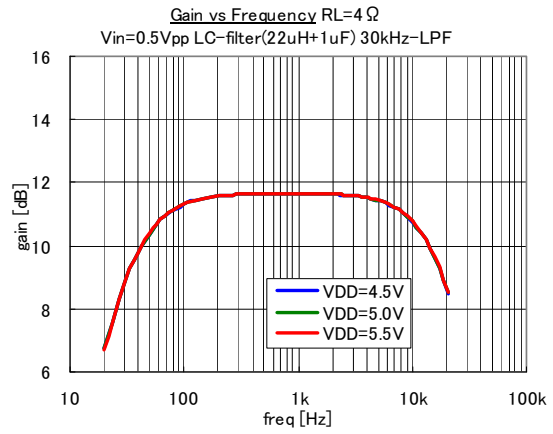

Fig.34

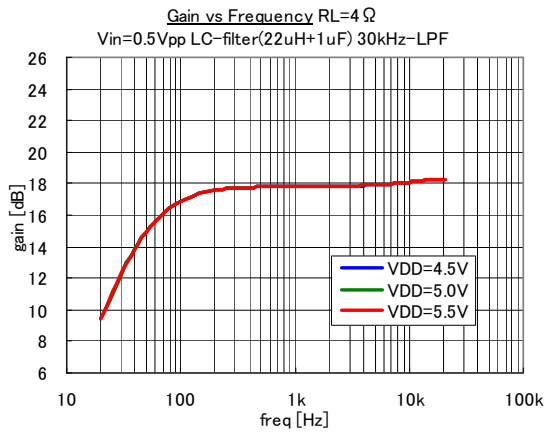

Fig.35

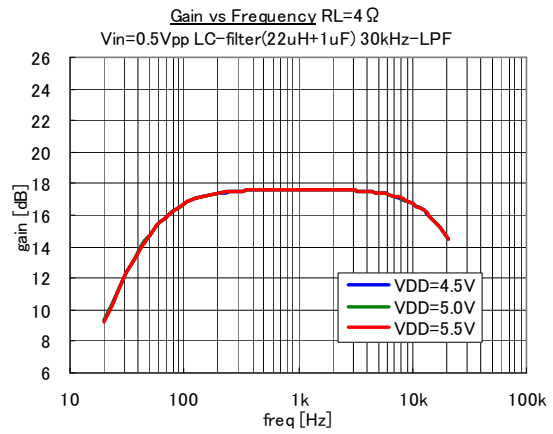

Fig.36

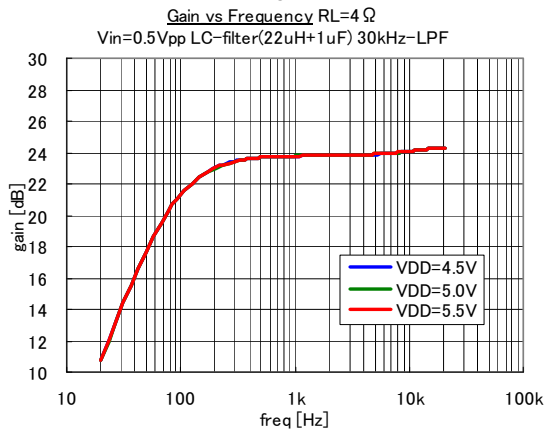

Fig.37

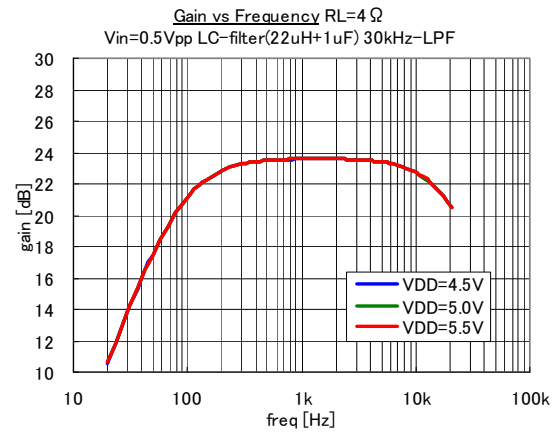
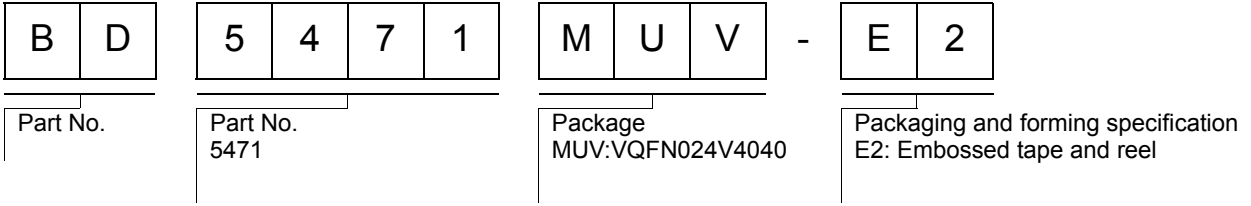

Fig.38

●Notes for use

- (1) Absolute maximum ratings
This IC may be damaged if the absolute maximum ratings for the applied voltage, temperature range, or other parameters are exceeded. Therefore, avoid using a voltage or temperature that exceeds the absolute maximum ratings. If it is possible that absolute maximum ratings will be exceeded, use fuses or other physical safety measures and determine ways to avoid exceeding the IC's absolute maximum ratings.
- (2) GND terminal's potential
Try to set the minimum voltage for GND terminal's potential, regardless of the operation mode.
- (3) Shorting between pins and mounting errors
When mounting the IC chip on a board, be very careful to set the chip's orientation and position precisely. When the power is turned on, the IC may be damaged if it is not mounted correctly. The IC may also be damaged if a short occurs (due to a foreign object, etc.) between two pins, between a pin and the power supply, or between a pin and the GND.
- (4) Operation in strong magnetic fields
Note with caution that operation faults may occur when this IC operates in a strong magnetic field.
- (5) Thermal design
Ensure sufficient margins to the thermal design by taking in to account the allowable power dissipation during actual use modes, because this IC is power amp. When excessive signal inputs which the heat dissipation is insufficient condition, it is possible that thermal shutdown circuit is active.
- (6) Thermal shutdown circuit
This product is provided with a built-in thermal shutdown circuit. When the thermal shutdown circuit operates, the output transistors are placed under open status. The thermal shutdown circuit is primarily intended to shut down the IC avoiding thermal runaway under abnormal conditions with a chip temperature exceeding $T_{jmax} = +150^{\circ}\text{C}$, and is not intended to protect and secure an electrical appliance.
- (7) Load of the output terminal
This IC corresponds to dynamic speaker load, and doesn't correspond to the load except for dynamic speakers.
- (8) The short protection of the output terminal
This IC is built in the short protection for a protection of output transistors. When the short protection is operated, output terminal become Hi-Z condition and is stopped with latch. Once output is stopped with latch, output does not recover automatically by canceling the short-circuiting condition. The condition of stopping with latch is cancelled, when power supply or mute signal is turned off and turned on again.
- (9) Operating ranges
The rated operating power supply voltage range ($V_{DD}=+4.5\text{V} \sim +5.5\text{V}$) and the rated operating temperature range ($T_a=-40^{\circ}\text{C} \sim +85^{\circ}\text{C}$) are the range by which basic circuit functions is operated. Characteristics and rated output power are not guaranteed in all power supply voltage ranges or temperature ranges.
- (10) Electrical characteristics
Electrical characteristics show the typical performance of device and depend on board layout, parts, power supply. The standard value is in mounting device and parts on surface of ROHM's board directly.
- (11) Maximum output power
When stereo inputs at $R_L=4\ \Omega$, maximum output power may not achieve up to typical value because the device heats. Ensure sufficient margins to the thermal design to get larger output power.
- (12) Power decoupling capacitor
Because the big peak current flows through the power line, the class-D amplifier has an influence on the Audio characteristic by the capacitance value or the arrangement part of the power decoupling capacitor.
- (13) Power supply
Use single power supply, because power supplies (4,10,15,21pin) of audio amplifier and regulator are shorted inside. Audio

●Ordering part number



VQFN024V4040

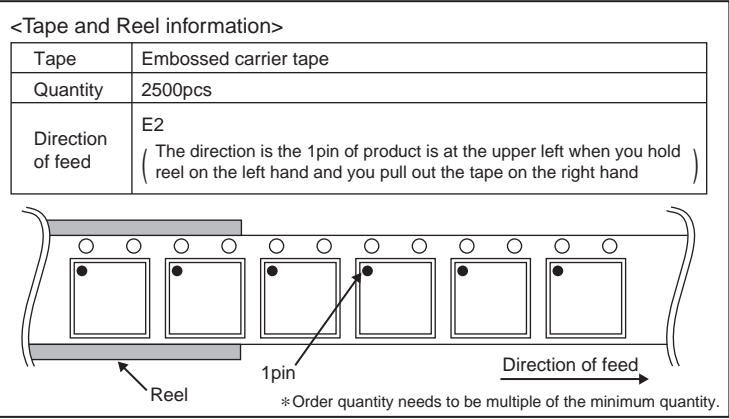
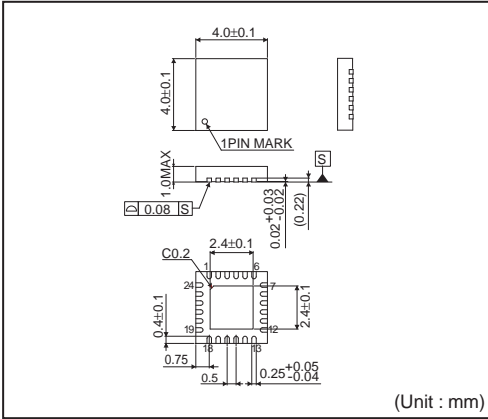

Notice

Precaution on using ROHM Products

- Our Products are designed and manufactured for application in ordinary electronic equipments (such as AV equipment, OA equipment, telecommunication equipment, home electronic appliances, amusement equipment, etc.). If you intend to use our Products in devices requiring extremely high reliability (such as medical equipment ^(Note 1), transport equipment, traffic equipment, aircraft/spacecraft, nuclear power controllers, fuel controllers, car equipment including car accessories, safety devices, etc.) and whose malfunction or failure may cause loss of human life, bodily injury or serious damage to property ("Specific Applications"), please consult with the ROHM sales representative in advance. Unless otherwise agreed in writing by ROHM in advance, ROHM shall not be in any way responsible or liable for any damages, expenses or losses incurred by you or third parties arising from the use of any ROHM's Products for Specific Applications.

(Note1) Medical Equipment Classification of the Specific Applications

JAPAN	USA	EU	CHINA
CLASS III	CLASS III	CLASS II b	CLASS III
CLASS IV		CLASS III	

- ROHM designs and manufactures its Products subject to strict quality control system. However, semiconductor products can fail or malfunction at a certain rate. Please be sure to implement, at your own responsibilities, adequate safety measures including but not limited to fail-safe design against the physical injury, damage to any property, which a failure or malfunction of our Products may cause. The following are examples of safety measures:
 - Installation of protection circuits or other protective devices to improve system safety
 - Installation of redundant circuits to reduce the impact of single or multiple circuit failure
- Our Products are designed and manufactured for use under standard conditions and not under any special or extraordinary environments or conditions, as exemplified below. Accordingly, ROHM shall not be in any way responsible or liable for any damages, expenses or losses arising from the use of any ROHM's Products under any special or extraordinary environments or conditions. If you intend to use our Products under any special or extraordinary environments or conditions (as exemplified below), your independent verification and confirmation of product performance, reliability, etc. prior to use, must be necessary:
 - Use of our Products in any types of liquid, including water, oils, chemicals, and organic solvents
 - Use of our Products outdoors or in places where the Products are exposed to direct sunlight or dust
 - Use of our Products in places where the Products are exposed to sea wind or corrosive gases, including Cl₂, H₂S, NH₃, SO₂, and NO₂
 - Use of our Products in places where the Products are exposed to static electricity or electromagnetic waves
 - Use of our Products in proximity to heat-producing components, plastic cords, or other flammable items
 - Sealing or coating our Products with resin or other coating materials
 - Use of our Products without cleaning residue of flux (even if you use no-clean type fluxes, cleaning residue of flux is recommended); or Washing our Products by using water or water-soluble cleaning agents for cleaning residue after soldering
 - Use of the Products in places subject to dew condensation
- The Products are not subject to radiation-proof design.
- Please verify and confirm characteristics of the final or mounted products in using the Products.
- In particular, if a transient load (a large amount of load applied in a short period of time, such as pulse. is applied, confirmation of performance characteristics after on-board mounting is strongly recommended. Avoid applying power exceeding normal rated power; exceeding the power rating under steady-state loading condition may negatively affect product performance and reliability.
- De-rate Power Dissipation (Pd) depending on Ambient temperature (Ta). When used in sealed area, confirm the actual ambient temperature.
- Confirm that operation temperature is within the specified range described in the product specification.
- ROHM shall not be in any way responsible or liable for failure induced under deviant condition from what is defined in this document.

Precaution for Mounting / Circuit board design

- When a highly active halogenous (chlorine, bromine, etc.) flux is used, the residue of flux may negatively affect product performance and reliability.
- In principle, the reflow soldering method must be used; if flow soldering method is preferred, please consult with the ROHM representative in advance.

For details, please refer to ROHM Mounting specification

Precautions Regarding Application Examples and External Circuits

1. If change is made to the constant of an external circuit, please allow a sufficient margin considering variations of the characteristics of the Products and external components, including transient characteristics, as well as static characteristics.
2. You agree that application notes, reference designs, and associated data and information contained in this document are presented only as guidance for Products use. Therefore, in case you use such information, you are solely responsible for it and you must exercise your own independent verification and judgment in the use of such information contained in this document. ROHM shall not be in any way responsible or liable for any damages, expenses or losses incurred by you or third parties arising from the use of such information.

Precaution for Electrostatic

This Product is electrostatic sensitive product, which may be damaged due to electrostatic discharge. Please take proper caution in your manufacturing process and storage so that voltage exceeding the Products maximum rating will not be applied to Products. Please take special care under dry condition (e.g. Grounding of human body / equipment / solder iron, isolation from charged objects, setting of Ionizer, friction prevention and temperature / humidity control).

Precaution for Storage / Transportation

1. Product performance and soldered connections may deteriorate if the Products are stored in the places where:
 - [a] the Products are exposed to sea winds or corrosive gases, including Cl₂, H₂S, NH₃, SO₂, and NO₂
 - [b] the temperature or humidity exceeds those recommended by ROHM
 - [c] the Products are exposed to direct sunshine or condensation
 - [d] the Products are exposed to high Electrostatic
2. Even under ROHM recommended storage condition, solderability of products out of recommended storage time period may be degraded. It is strongly recommended to confirm solderability before using Products of which storage time is exceeding the recommended storage time period.
3. Store / transport cartons in the correct direction, which is indicated on a carton with a symbol. Otherwise bent leads may occur due to excessive stress applied when dropping of a carton.
4. Use Products within the specified time after opening a humidity barrier bag. Baking is required before using Products of which storage time is exceeding the recommended storage time period.

Precaution for Product Label

QR code printed on ROHM Products label is for ROHM's internal use only.

Precaution for Disposition

When disposing Products please dispose them properly using an authorized industry waste company.

Precaution for Foreign Exchange and Foreign Trade act

Since our Products might fall under controlled goods prescribed by the applicable foreign exchange and foreign trade act, please consult with ROHM representative in case of export.

Precaution Regarding Intellectual Property Rights

1. All information and data including but not limited to application example contained in this document is for reference only. ROHM does not warrant that foregoing information or data will not infringe any intellectual property rights or any other rights of any third party regarding such information or data. ROHM shall not be in any way responsible or liable for infringement of any intellectual property rights or other damages arising from use of such information or data.:
2. No license, expressly or implied, is granted hereby under any intellectual property rights or other rights of ROHM or any third parties with respect to the information contained in this document.

Other Precaution

1. This document may not be reprinted or reproduced, in whole or in part, without prior written consent of ROHM.
2. The Products may not be disassembled, converted, modified, reproduced or otherwise changed without prior written consent of ROHM.
3. In no event shall you use in any way whatsoever the Products and the related technical information contained in the Products or this document for any military purposes, including but not limited to, the development of mass-destruction weapons.
4. The proper names of companies or products described in this document are trademarks or registered trademarks of ROHM, its affiliated companies or third parties.

General Precaution

1. Before you use our Products, you are requested to carefully read this document and fully understand its contents. ROHM shall not be in any way responsible or liable for failure, malfunction or accident arising from the use of any ROHM's Products against warning, caution or note contained in this document.
2. All information contained in this document is current as of the issuing date and subject to change without any prior notice. Before purchasing or using ROHM's Products, please confirm the latest information with a ROHM sales representative.
3. The information contained in this document is provided on an "as is" basis and ROHM does not warrant that all information contained in this document is accurate and/or error-free. ROHM shall not be in any way responsible or liable for any damages, expenses or losses incurred by you or third parties resulting from inaccuracy or errors of or concerning such information.