

SPEC

Spec No.	TQ3C-8EAF0-E1DEY71-00
Date	September 9, 2016

TYPE : TCG062HVLQAVNN-GN20

< 6.2 inch HVGA transmissive color TFT with LED backlight
and constant current circuit for LED backlight >

CONTENTS

1. Application
2. Construction and outline
3. Mechanical specifications
4. Absolute maximum ratings
5. Electrical characteristics
6. Optical characteristics
7. Interface signals
8. Input timing characteristics
9. Backlight characteristics
10. Lot number identification
11. Warranty
12. Precautions for use
13. Reliability test data
14. Outline drawing



KYOCERA DISPLAY CORPORATION

This specification is subject to change without notice.
Consult Kyocera before ordering.

Original Issue Date	Designed by: Engineering dept.			Confirmed by: QA dept.	
	Prepared	Checked	Approved	Checked	Approved
September 9, 2016	M. Koyama	Y. Yamaguchi	Y. Matsumoto	O. Sato	I. Hamada

Warning

1. This Kyocera LCD module has been specifically designed for use only in electronic devices and industrial machines in the area of audio control, office automation, industrial control, home appliances, etc. The module should not be used in applications where the highest level of safety and reliability are required and module failure or malfunction of such module results in physical harm or loss of life, as well as enormous damage or loss. Such fields of applications include, without limitation, medical, aerospace, communications infrastructure, atomic energy control. Kyocera expressly disclaims any and all liability resulting in any way to the use of the module in such applications.
2. Customer agrees to indemnify, defend and hold Kyocera harmless from and against any and all actions, claims, damages, liabilities, awards, costs, and expenses, including legal expenses, resulting from or arising out of Customer's use, or sale for use, or Kyocera modules in applications.

Caution

1. Kyocera shall have the right, which Customer hereby acknowledges, to immediately scrap or destroy tooling for Kyocera modules for which no Purchase Orders have been received from the Customer in a two-year period.

Spec No. TQ3C-8EAF0-E1DEY71-00	Part No. TCG062HVLQAVNN-GN20	Page -
-----------------------------------	---------------------------------	-----------

Revision record

Date		Designed by : Engineering dept.			Confirmed by : QA dept.	
		Prepared	Checked	Approved	Checked	Approved
Rev. No.	Date	Page	Descriptions			

1. Application

This document defines the specification of TCG062HVLQAVNN-GN20 (RoHS Compliant)

2. Construction and outline

LCD	: Transmissive color dot matrix type TFT
Backlight system	: LED
Polarizer	: Glare treatment
Additional circuit	: Power supply (3.3V input) (with constant current circuit for LED Backlight)

3. Mechanical specifications

Item	Specification	Unit
Outline dimensions 1)	173(W)×70(H)×6.7(D)	mm
Active area	147.84(W)×55.44(H) (15.8cm/6.2 inch(Diagonal))	mm
Effective viewing area	149.8(W)×57.4(H)	mm
Dot format	640×(B,G,R)(W)×240(H)	dot
Dot pitch	0.077(W)×0.231(H)	mm
Base color 2)	Normally Black	-
Mass	115	g

- 1) Projection not included. Please refer to outline for details.
- 2) Due to the characteristics of the LCD material, the color varies with environmental temperature.

4. Absolute maximum ratings

4-1. Electrical absolute maximum ratings

Item		Symbol	Min.	Max.	Unit
Supply voltage for LCD drive		V _{DD}	0	4.0	V
Supply voltage for Backlight		V _{INB}	0	6.0	V
Input signal voltage	RxIN _i +, RxIN _i - 1) 2)	V _{I1}	-0.3	V _{DD}	V
	RxCK IN+, RxCK IN- 2)	V _{I2}	-0.3	V _{DD}	V
	SC	V _{I3}	-0.3	V _{DD}	V
	BLEN (Backlight ON-OFF)	V _{I4}	0	V _{INB}	V
	VBRT (Brightness adjust voltage)	V _{I5}	0	V _{INB}	V

1) i=0,1,2

2) V_{DD} must be supplied correctly within the range described in 5-1.

4-2. Environmental absolute maximum ratings

Item		Symbol	Min.	Max.	Unit
Operating temperature	1)	T _{OP}	-20	70	°C
Storage temperature	2)	T _{STO}	-30	80	°C
Operating humidity	3)	H _{OP}	10	4)	%RH
Storage humidity	3)	H _{STO}	10	4)	%RH
Vibration	-	-	5)	5)	-
Shock	-	-	6)	6)	-

1) Operating temperature means a temperature which operation shall be guaranteed. Since display performance is evaluated at 25°C, another temperature range should be confirmed.

2) Temp. = -30°C < 48h , Temp. = 80°C < 168h

Store LCD at normal temperature/humidity. Keep them free from vibration and shock.

An LCD that is kept at a low or a high temperature for a long time can be defective due to other conditions, even if the low or high temperature satisfies the standard.

(Please refer to “Precautions for Use” for details.)

3) Non-condensing

4) Temp. ≤ 40°C, 85%RH Max.

Temp. > 40°C, Absolute humidity shall be less than 85%RH at 40°C.

5)

Frequency	10~55 Hz	Acceleration value (0.3~9 m/s ²)
Vibration width	0.15mm	
Interval	10-55-10 Hz	1 minutes

2 hours in each direction X, Y, Z (6 hours total)

EIAJ ED-2531

6) Acceleration: 490 m/s², Pulse width: 11 ms

3 times in each direction: ±X, ±Y, ±Z

EIAJ ED-2531

5. Electrical characteristics

5-1. LCD

Temp. = -20~70°C

Item	Symbol	Condition	Min.	Typ.	Max.	Unit
Supply voltage	1) V_{DD}	-	3.0	3.3	3.6	V
Current consumption	I_{DD}	2)	-	80	105	mA
Permissive input ripple voltage	V_{RP}	$V_{DD}=3.3V$	-	-	100	mVp-p
Input signal voltage	3) V_{IL}	"Low" level	0	-	$0.2 V_{DD}$	V
		V_{IH}	"High" level	$0.8 V_{DD}$	-	V_{DD}
Input leak current	3) I_{OL}	$V_{I3}=0V$	-10	-	10	μA
		$V_{I3}=3.3V$	-	-	350	μA
Differential input voltage	4) $ V_{ID} $	-	100	-	600	mV
Differential input threshold voltage	4) V_{TL}	"Low" level	-100	-	-	mV
		V_{TH}	"High" level	-	-	100
LVDS Common mode voltage	4) V_{ICM}	-	$ V_{ID} /2$	1.2	$2.4 - V_{ID} /2$	V
Terminator	R_1	-	-	100	-	Ω

1) V_{DD} -turn-on conditions

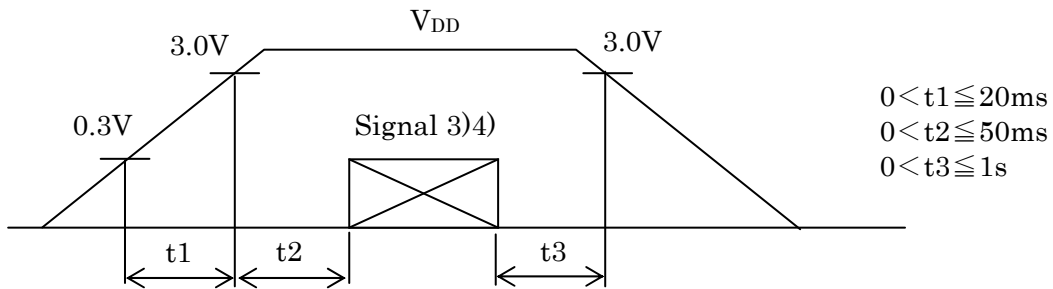

2) Display pattern:

$V_{DD} = 3.3V$, Temp. = 25°C

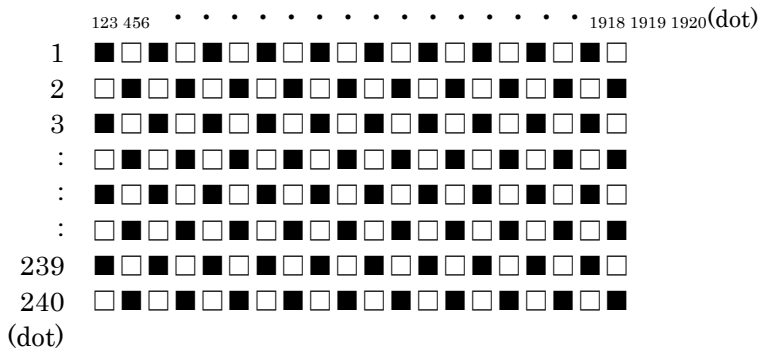

3) Input signal : SC

4) Input signal : RxIN2+, RxIN2-, RxIN1+, RxIN1-, RxIN0+, RxIN0-, RxCKIN+, RxCKIN-

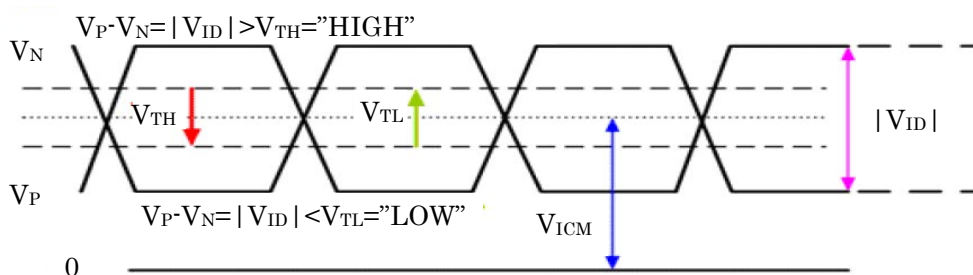

6. Optical characteristics

Measuring spot = ϕ 6.0mm, Temp. = 25°C

Item	Symbol	Condition	Min.	Typ.	Max.	Unit	
Response time	Rise	τ_r	$\theta = \phi = 0^\circ$	-	18	-	ms
	Down	τ_d	$\theta = \phi = 0^\circ$	-	12	-	ms
Viewing angle range	θ UPPER	CR \geq 10	-	85	-	deg.	
	θ LOWER		-	85	-		
	ϕ LEFT		-	85	-	deg.	
	ϕ RIGHT		-	85	-		
Contrast ratio	CR	$\theta = \phi = 0^\circ$	300	500	-	-	
Brightness	L	IF=15mA/Line	350	500	-	cd/m ²	
Chromaticity coordinates	Red	x	$\theta = \phi = 0^\circ$	0.540	0.590	0.640	-
		y		0.300	0.350	0.400	
	Green	x	$\theta = \phi = 0^\circ$	0.285	0.335	0.385	
		y		0.530	0.580	0.630	
	Blue	x	$\theta = \phi = 0^\circ$	0.110	0.160	0.210	
		y		0.070	0.120	0.170	
	White	x	$\theta = \phi = 0^\circ$	0.255	0.305	0.355	
		y		0.275	0.325	0.375	

6-1. Definition of contrast ratio

$$\text{CR(Contrast ratio)} = \frac{\text{Brightness with all pixels "White"}}{\text{Brightness with all pixels "Black"}}$$

6-2. Definition of response time

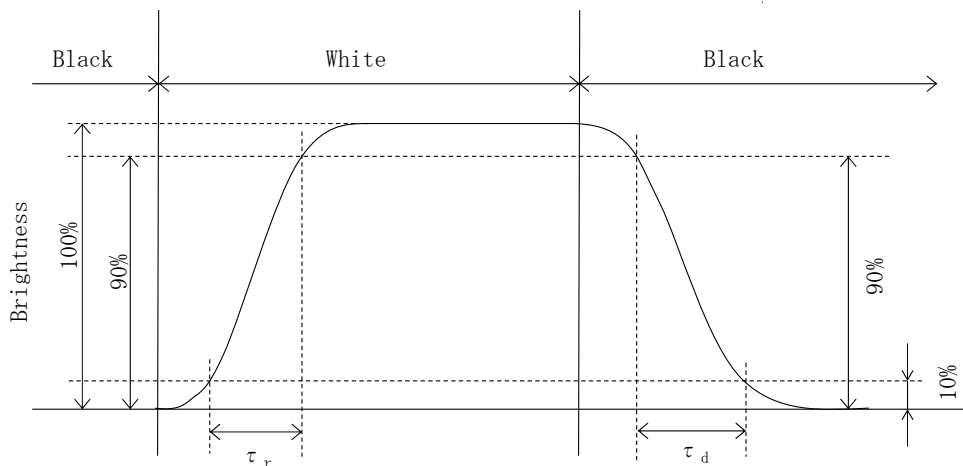

6-3. Definition of viewing angle

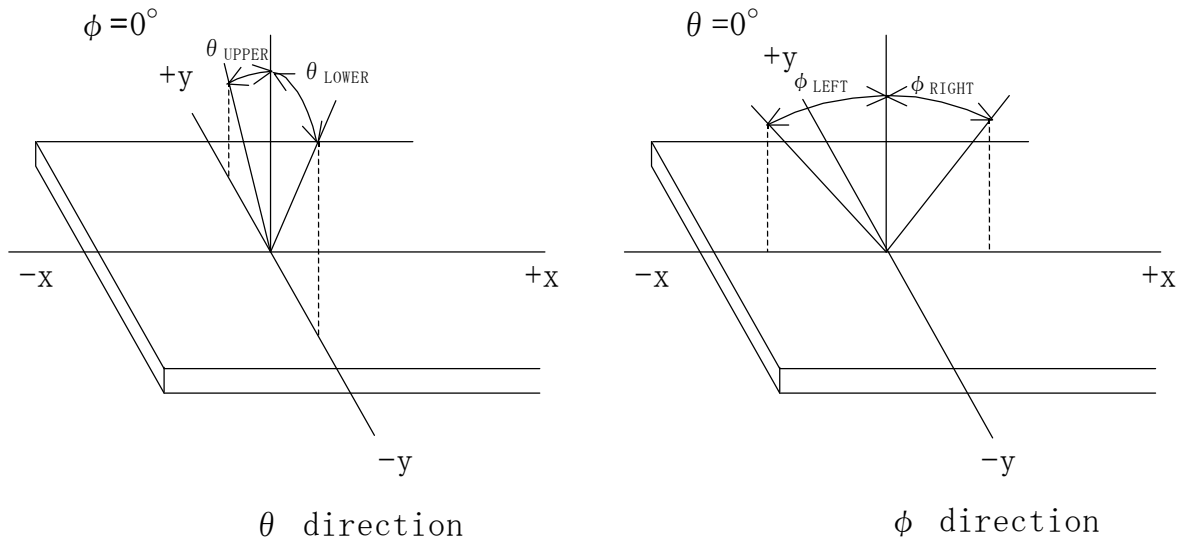

6-4. Brightness measuring points

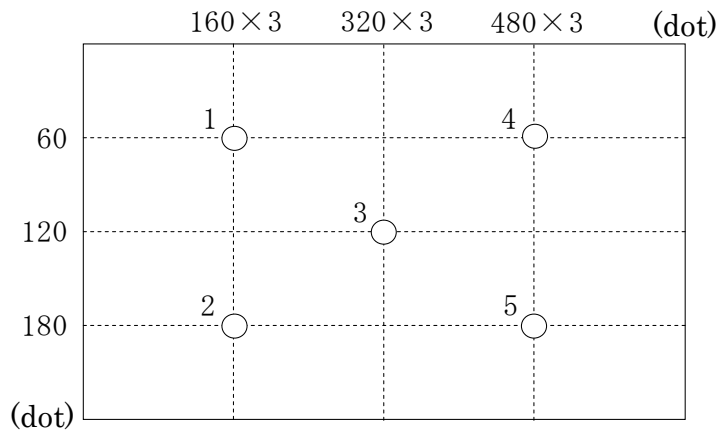

- 1) Rating is defined on the average in the viewing area. (measured point 1~5)
- 2) Measured 5 minutes after the LED is powered on. (Ambient temp. = 25°C)

7. Interface signals

7-1. LCD

No.	Symbol	Description	Note
1	GNDB	GND for LED backlight	
2	GNDB	GND for LED backlight	
3	GNDB	GND for LED backlight	
4	VBRT	Brightness adjust voltage (0V[max]~2.8V[min])	
5	BLEN	Backlight ON-OFF (H : ON , L : OFF)	
6	V _{INB}	Power supply for LED backlight	
7	V _{INB}	Power supply for LED backlight	
8	V _{INB}	Power supply for LED backlight	
9	NC	NC	
10	NC	NC	
11	V _{DD}	+3.3V power supply	
12	V _{DD}	+3.3V power supply	
13	GND	GND	
14	GND	GND	
15	RxIN0-	LVDS receiver signal CH0(-)	LVDS
16	RxIN0+	LVDS receiver signal CH0(+)	LVDS
17	GND	GND	
18	RxIN1-	LVDS receiver signal CH1(-)	LVDS
19	RxIN1+	LVDS receiver signal CH1(+)	LVDS
20	GND	GND	
21	RxIN2-	LVDS receiver signal CH2(-)	LVDS
22	RxIN2+	LVDS receiver signal CH2(+)	LVDS
23	GND	GND	
24	RxCKIN-	LVDS receiver signal CK(-)	LVDS
25	RxCKIN+	LVDS receiver signal CK(+)	LVDS
26	GND	GND	
27	NC	NC	
28	NC	NC	
29	GND	GND	
30	SC	Scan direction control (GND or Open: Normal, High: Reverse)	1)

LCD connector : MDF76GW-30S-1H(55) (HIROSE)
 Matching connector : MDF76-30P-1C (HIROSE)

LVDS receiver : BU90R104(ROHM)
 Matching LVDS transmitter : BU8254KVT(ROHM) or compatible

1) Scanning

SC : GND or Open

SC : High

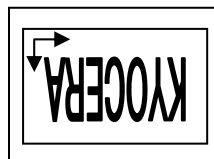

8. Input timing characteristics

8-1. Timing characteristics

Item		Symbol	Min.	Typ.	Max.	Unit	Note
Clock (CK)	Frequency	1/Tc	11.58	12.85	14.16	MHz	
Enable signal (DE)	Horizontal Period	Th	766	816	866	Tc	
			54.1	63.5	-	μs	1)
	Horizontal display period	Thd	640			Tc	
	Vertical Period	Tv	250	262	320	Th	
	Vertical display period	Tvd	240			Th	
Refresh rate		fv	50	60	70	Hz	2)

- 1) Please set a clock frequency, a vertical dormant period, and the horizontal dormant period so that the Horizontal Period should not reach less than Min. value.
- 2) If the refresh rate reach less than Min. value, the deterioration of the display quality, flicker etc., may occur. ($fv=1/Tv$)
- 3) CK count of each Horizontal Scanning Time should be always the same. Vertical invalid data period should be "n" × "Horizontal Scanning Time". (n: integer) Frame period should be always the same.

Vertical Timing Diagram

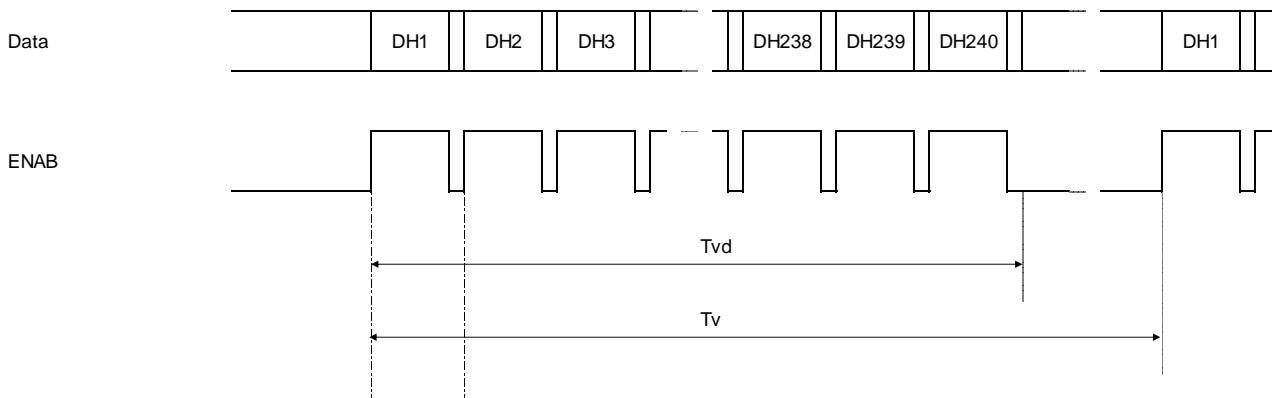

Horizontal Timing Diagram

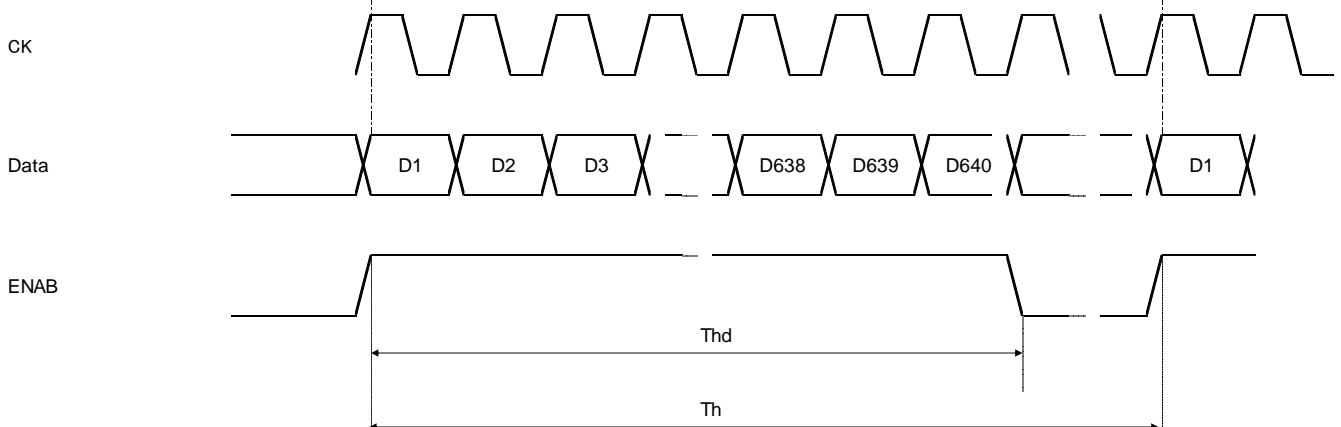

8-2. Data

8-2-1. 6bit Input

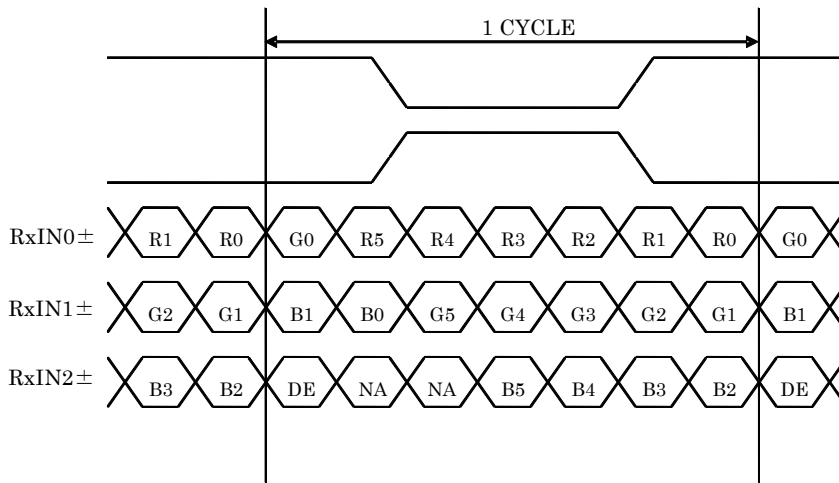

DE : Data Enable
NA : Not Applicable

8-3. Input Data Signals and Display position on the screen

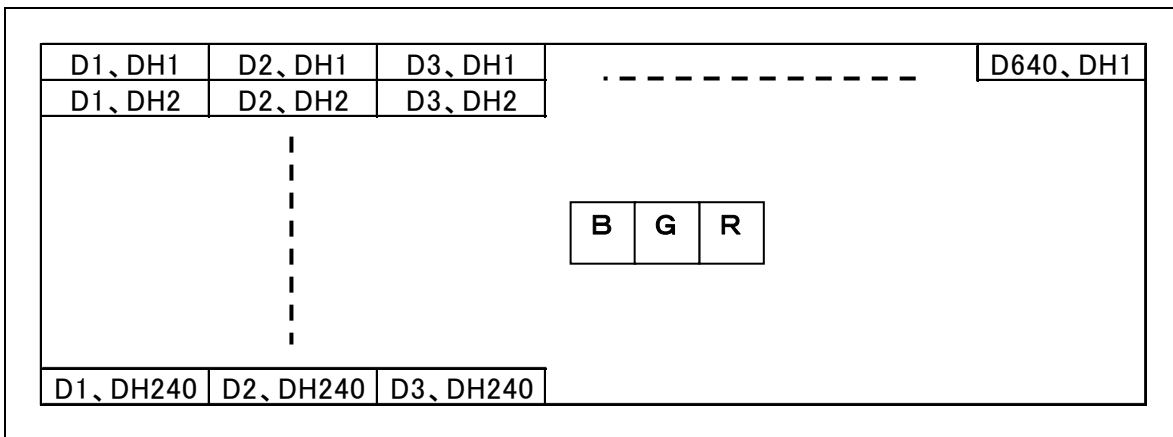

9. Backlight characteristics

Temp.=25°C

Item	Symbol	Min.	Typ.	Max.	Unit	Note
Supply voltage	V_{INB}	3.0	-	5.5	V	$T_a = -20 \sim 70^\circ\text{C}$
ON-OFF (H)	BLEN	$0.8V_{INB}$	-	V_{INB}	V	-
ON-OFF (L)		0.0	-	$0.2V_{INB}$	V	-
LED forward current 1) 2)	IF	14	15	16	mA	VBRT=0~1.4V
		2.8	3.0	3.2		VBRT=2.8V
Supply current	I_{INB}	-	350	450	mA	$V_{INB} = 3.3\text{V}$, IF=15mA
		-	220	290		$V_{INB} = 5.0\text{V}$, IF=15mA
Operating life 3) 4)	T	-	40,000	-	h	IF=15mA, $T_a = 25^\circ\text{C}$

- 1) For each LED.
- 2) A forward current below 5.0mA may reduce the brightness uniformity of the LED backlight. This is because the amount of light from each LED chip is different. Therefore, please evaluate carefully before finalizing the input current.
- 3) When brightness decrease 50% of minimum brightness.
The average life of a LED will decrease when the LCD is operating at higher temperatures.
- 4) Life time is estimated data. (Condition : IF=15mA, $T_a = 25^\circ\text{C}$ in chamber).
- 5) When you start-up, please charge in sequence of $V_{INB} \rightarrow \text{BLEN}$, or VBRT. When you shut-down, please stop in sequence of BLEN and/or VBRT $\rightarrow V_{INB}$.
- 6) Please do not connect the other than our backlight to this output connector on the PCB.
- 7) In case V_{DD} and V_{INB} are supplied by a single power source, V_{DD} & V_{INB} , and GND & GNDB are connected directly and separately from the output on the power source. If the common wire are used for V_{DD} & V_{INB} , and for GND & GNDB, and are split near the PCB, and connect to each LCD driving circuit and backlight driving circuit, a flicker might be occurred due to a ripple between the both circuit.

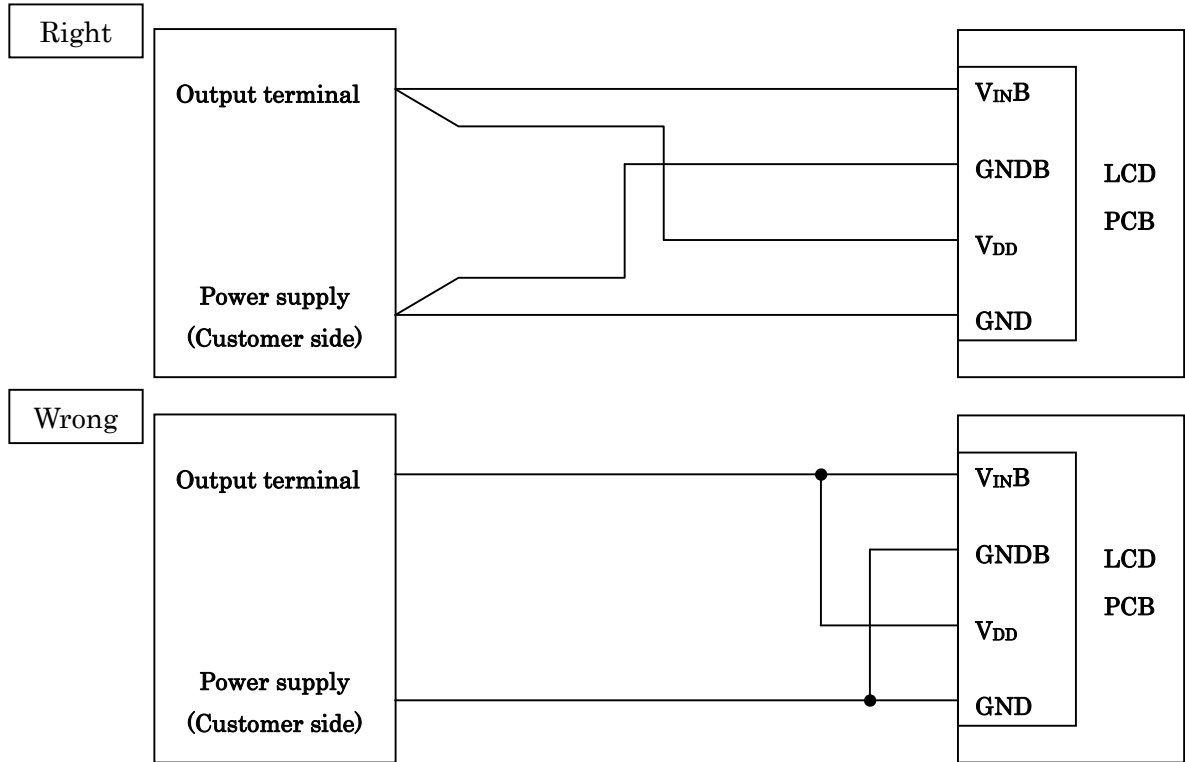

8) VBRT-IF characteristics

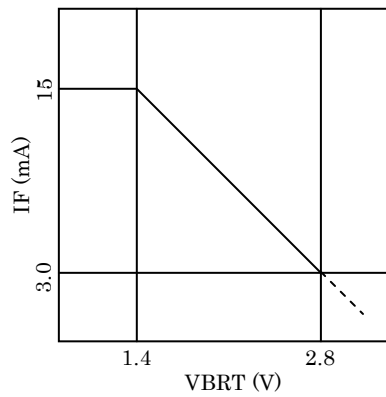

12. Precautions for use

12-1. Installation of the LCD

- 1) A transparent protection plate shall be added to protect the LCD and its polarizer
- 2) The LCD shall be installed so that there is no pressure on the LSI chips.
- 3) The LCD shall be installed flat, without twisting or bending.
- 4) Please design the housing window so that its edges are between the active area and the effective area of the LCD screen.
- 5) A transparent protection sheet is attached to the polarizer. Please remove the protection film slowly before use, paying attention to static electricity.

12-2. Static electricity

- 1) Since CMOS ICs are mounted directly onto the LCD glass, protection from static electricity is required.
- 2) Workers should use body grounding. Operator should wear ground straps.

12-3. LCD operation

- 1) The LCD shall be operated within the limits specified. Operation at values outside of these limits may shorten life, and/or harm display images.

12-4. Storage

- 1) The LCD shall be stored within the temperature and humidity limits specified.
Store in a dark area, and protect the LCD from direct sunlight or fluorescent light.
- 2) Always store the LCD so that it is free from external pressure onto it.

12-5. Usage

- 1) **DO NOT** store in a high humidity environment for extended periods. Polarizer degradation bubbles, and/or peeling off of the polarizer may result.
- 2) The front polarizer is easily scratched or damaged. Prevent touching it with any hard material, and from being pushed or rubbed.
- 3) The LCD screen may be cleaned by wiping the screen surface with a soft cloth or cotton pad using a little Ethanol.
- 4) Water may cause damage or discoloration of the polarizer. Clean condensation or moisture from any source immediately.
- 5) Always keep the LCD free from condensation during testing. Condensation may permanently spot or stain the polarizer.
- 6) Do not disassemble LCD because it will result in damage.
- 7) This Kyocera LCD has been specifically designed for use in general electronic devices, but not for use in a special environment such as usage in an active gas. Hence, when the LCD is supposed to be used in a special environment, evaluate the LCD thoroughly beforehand and do not expose the LCD to chemicals such as an active gas.
- 8) Please do not use solid-base image pattern for long hours because a temporary afterimage may appear. We recommend using screen saver etc. in cases where a solid-base image pattern must be used.
- 9) Liquid crystal may leak when the LCD is broken. Be careful not to let the fluid go into your eyes and mouth. In the case the fluid touches your body; rinse it off right away with water and soap.

13. Reliability test data

Test item	Test condition	Test time	Judgement
High temp. atmosphere	80°C	240h	Display function : No defect Display quality : No defect Current consumption : No defect
Low temp. atmosphere	-30°C	240h	Display function : No defect Display quality : No defect Current consumption : No defect
High temp. humidity atmosphere	40°C 90% RH	240h	Display function : No defect Display quality : No defect Current consumption : No defect
Temp. cycle	-30°C 0.5h R.T. 0.5h 80°C 0.5h	10cycles	Display function : No defect Display quality : No defect Current consumption : No defect
High temp. operation	70°C	500h	Display function : No defect Display quality : No defect Current consumption : No defect

- 1) Each test item uses a test LCD only once. The tested LCD is not used in any other tests.
- 2) The LCD is tested in circumstances in which there is no condensation.
- 3) The reliability test is not an out-going inspection.
- 4) The result of the reliability test is for your reference purpose only.
The reliability test is conducted only to examine the LCD's capability.

No	Description	Drawn	Checked	Checked	Approved

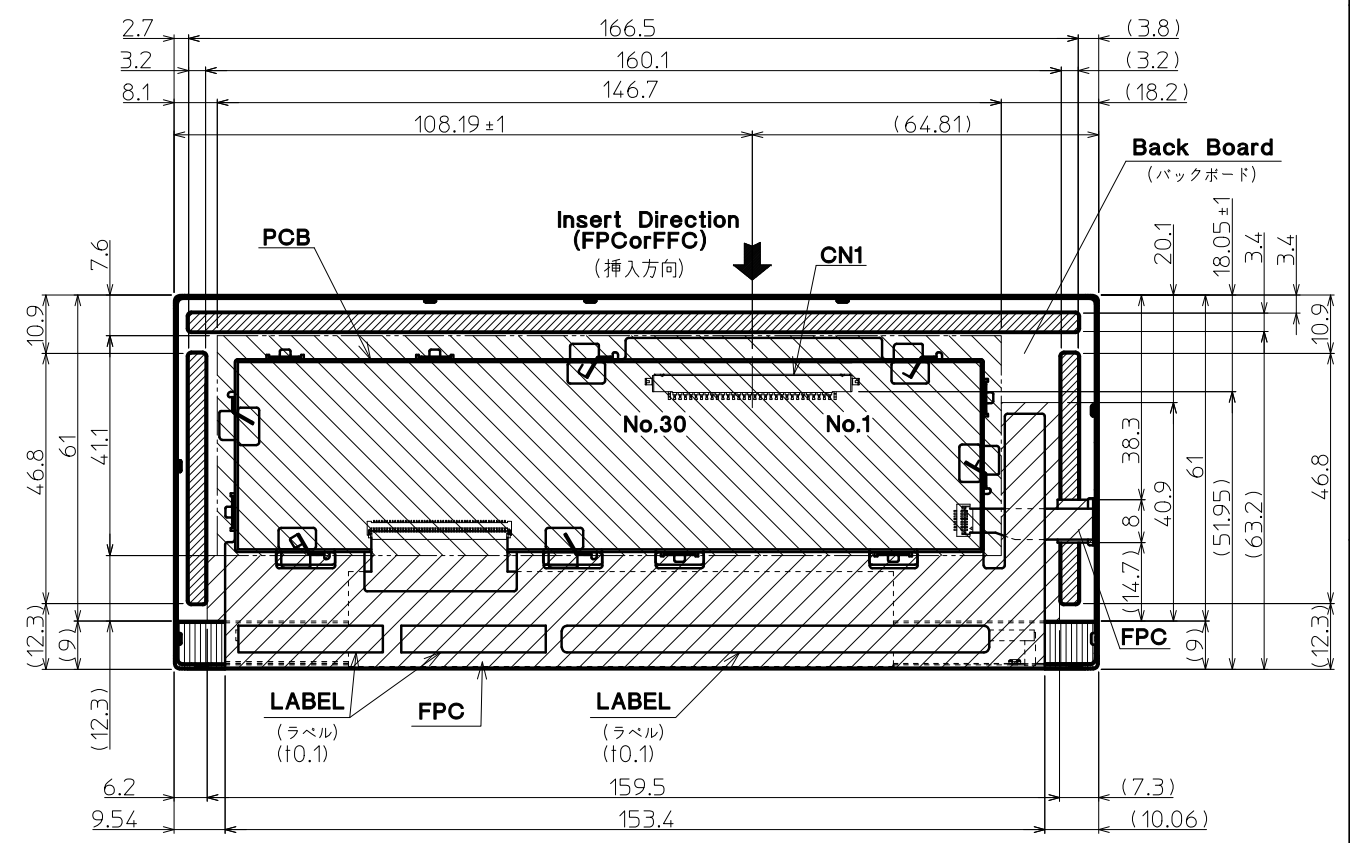
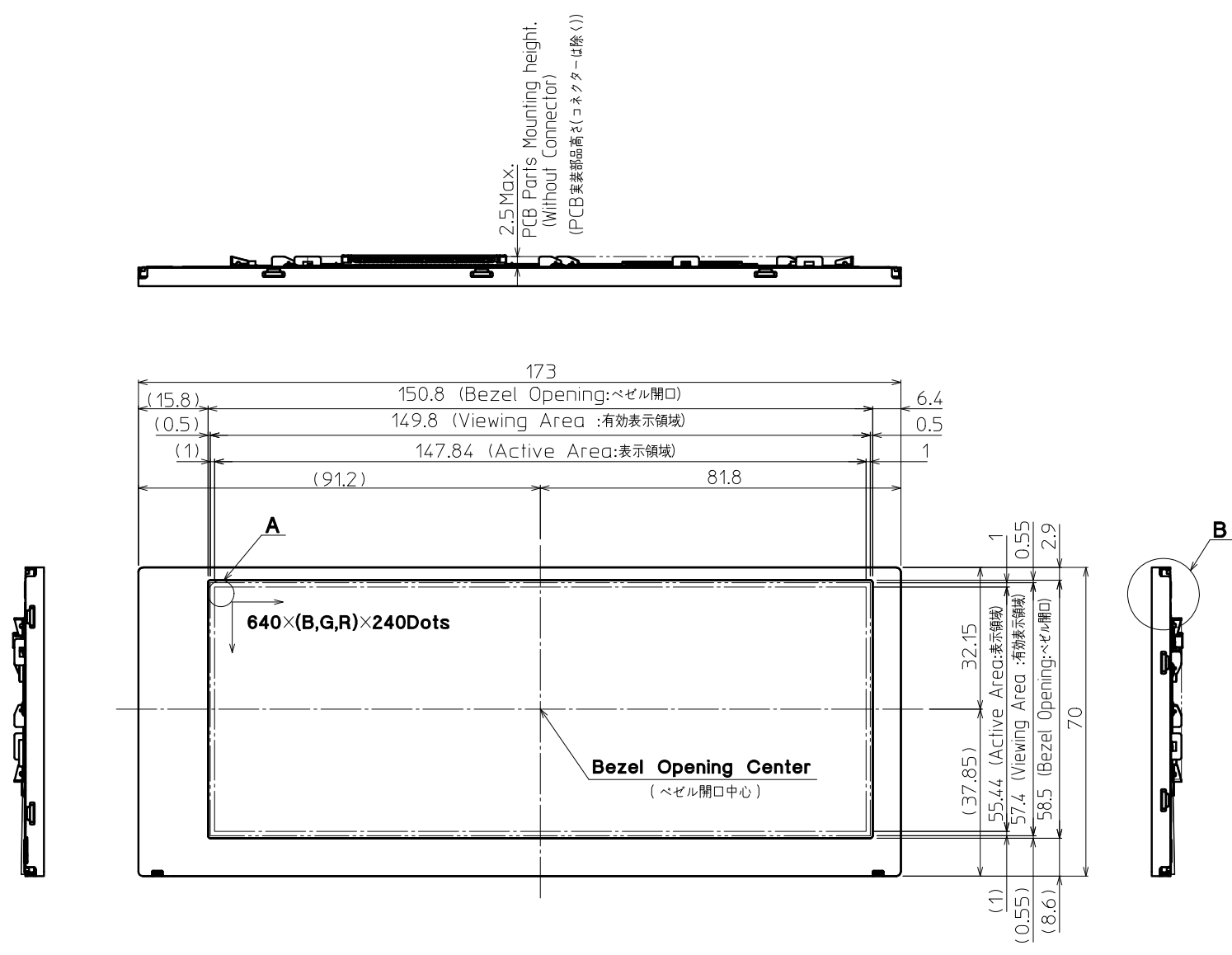

- : Projected part is 0.15mm height from Back Board. (裏面板金からの高さ0.15mm)
- : Projected part is 0.10mm height from Back Board. (裏面板金からの高さ0.10mm)
- : Projected part is 2.5mm height from Back Board. (裏面板金からの高さ2.5mm)
- : Projected part is 1.5mm height from Back Board. (裏面板金からの高さ1.5mm)

Note. (注記)

- Connector CN1: MDF76GW-30S-1H(55) (HIROSE) (コネクタ)
- Matching Connector CN1: MDF76-30P-1C (HIROSE) (適合コネクタ)
- The Information of LCD is displayed starting at the upper left hand corner, moving right then down to the lower right hand corner. (LCDにおいて、画像データの表示は左上コーナーから始まり、右へ進み下へ送られ右下コーナーへ向かう。)
- Tolerance without indication: ±0.5 (指示無き公差)
- There is a possibility that in-plane unevenness will be occurred by over twist, stress giving by attaching to LCD, and over pressure to touch panel. Please be careful of stress when designing the housing. (過度な捻じり(ひずみ)、LCD固定時での応力発生、タッチパネルでの過度な押し圧によっては、パネル面内にムラが発生することがありますので、筐体設計において、事前に十分確認願います。)

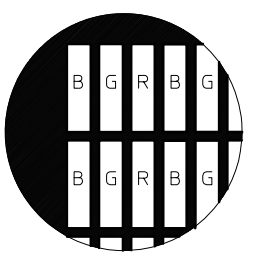

DETAIL A(Dot Size)
(NTS)

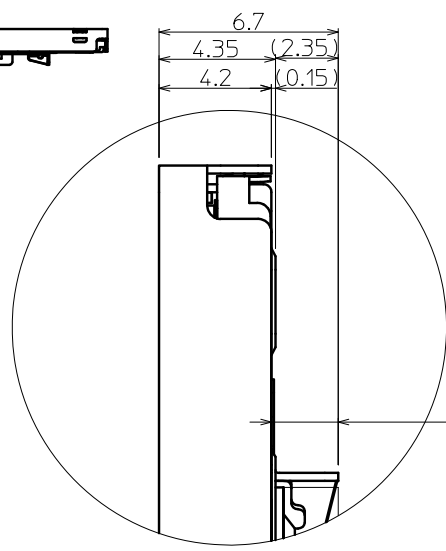

DETAIL B (5:1)

Material 材質	Treatment 処理	Approved '16.09.08	Checked	Checked '16.09.08	Drawn	Scale 1:1(5:1,NTS)	Title TCG062HVLQAVNN	KYOCERA	Year-Month-Day '16.09.08	Size 2
Quantity 製作数	Description; 備考	RoHS	阿部	倉元	蔭山	Outline Dimensions	Drawing No. 121A8095700			

Spec No.	TQ3C-8EAF0-E2DEY71-00
Date	September 9, 2016

KYOCERA INSPECTION STANDARD

TYPE : TCG062HVLQAVNN-GN20

KYOCERA DISPLAY CORPORATION

Original Issue Date	Designed by : Engineering dept.			Confirmed by : QA dept.	
	Prepared	Checked	Approved	Checked	Approved
September 9, 2016	M. Koyama	Y. Yamazaki	Y. MATSUMOTO	D. Sato	I. Kamae

Spec No. TQ3C-8EAF0-E2DEY71-00	Part No. TCG062HVLQAVNN-GN20	Page -
-----------------------------------	---------------------------------	-----------

Revision record

Date		Designed by : Engineering dept.			Confirmed by : QA dept.	
		Prepared	Checked	Approved	Checked	Approved
Rev.No.	Date	Page	Descriptions			

Visuals specification

1) Note

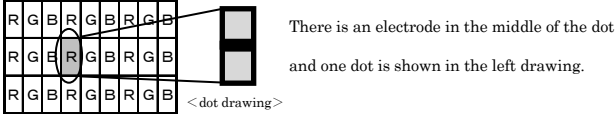
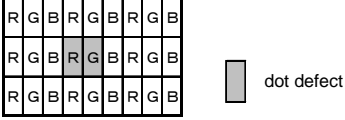
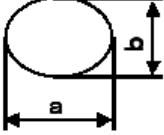
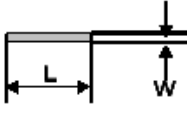
		Note		
General	<p>1. Customer identified anomalies not defined within this inspection standard shall be reviewed by Kyocera, and an additional standard shall be determined by mutual consent.</p> <p>2. This inspection standard about the image quality shall be applied to any defect within the effective active area and shall not be applicable to outside of the area.</p> <p>3. Inspection conditions</p> <p>Luminance : 500 Lux min.</p> <p>Inspection distance : 300 mm.</p> <p>Temperature : 25 ± 5°C</p> <p>Direction : Directly above</p>			
Definition of inspection item	Dot defect	Bright dot defect	<p>The dot is constantly “on” when power applied to the LCD, even when all “Black” data sent to the screen.</p> <p>Inspection tool: 5% Transparency neutral density filter.</p> <p>Count dot: If the dot is visible through the filter.</p> <p>Don't count dot: If the dot is not visible through the filter.</p> 	
		Black dot defect	<p>The dot is constantly “off” when power applied to the LCD, even when all “White” data sent to the screen.</p> <p>Similar size compared to bright dot.</p>	
		White dot (Circular/foreign particle)	<p>Pixel works electrically, however, circular/foreign particle makes dot appear to be “on” even when all “Black” data is sent to the screen.</p>	
		Adjacent dot	<p>Adjacent dot defect is defined as two or more bright dot defects or black dot defects.</p> 	
	External inspection	Bubble, Scratch, Foreign particle (Polarizer, Cell, Backlight)	Visible operating (all pixels “Black” or “White”) and non operating.	
		Appearance inspection	Does not satisfy the value at the spec.	
Definition of size	<p>Definition of circle size</p>  <p>$d = (a + b) / 2$</p>	<p>Definition of linear size</p> 		

2) Standard

Classification		Inspection item	Judgement standard																
Defect (in LCD glass)	Dot defect	Bright dot defect	Acceptable number : 4 Bright dot spacing : 5 mm or more																
		Black dot defect	Acceptable number : 5 Black dot spacing : 5 mm or more																
		2 dot join	Bright dot defect	Acceptable number : 2															
			Black dot defect	Acceptable number : 3															
		3 or more dots join	Acceptable number : 0																
		Total dot defects	Acceptable number : 5 Max																
	Others	White dot, Dark dot (Circle)	<table border="1"> <thead> <tr> <th>Size (mm)</th> <th>Acceptable number</th> </tr> </thead> <tbody> <tr> <td>$d \leq 0.2$</td> <td>(Neglected)</td> </tr> <tr> <td>$0.2 < d \leq 0.4$</td> <td>5</td> </tr> <tr> <td>$0.4 < d \leq 0.5$</td> <td>3</td> </tr> <tr> <td>$0.5 < d$</td> <td>0</td> </tr> </tbody> </table>			Size (mm)	Acceptable number	$d \leq 0.2$	(Neglected)	$0.2 < d \leq 0.4$	5	$0.4 < d \leq 0.5$	3	$0.5 < d$	0				
Size (mm)	Acceptable number																		
$d \leq 0.2$	(Neglected)																		
$0.2 < d \leq 0.4$	5																		
$0.4 < d \leq 0.5$	3																		
$0.5 < d$	0																		
External inspection (Defect on Polarizer or between Polarizer and LCD glass)	Polarizer (Scratch)	<table border="1"> <thead> <tr> <th>Width (mm)</th> <th>Length (mm)</th> <th>Acceptable number</th> </tr> </thead> <tbody> <tr> <td>$W \leq 0.1$</td> <td>—</td> <td>(Neglected)</td> </tr> <tr> <td rowspan="2">$0.1 < W \leq 0.3$</td> <td>$L \leq 5.0$</td> <td>(Neglected)</td> </tr> <tr> <td>$5.0 < L$</td> <td>0</td> </tr> <tr> <td>$0.3 < W$</td> <td>—</td> <td>0</td> </tr> </tbody> </table>			Width (mm)	Length (mm)	Acceptable number	$W \leq 0.1$	—	(Neglected)	$0.1 < W \leq 0.3$	$L \leq 5.0$	(Neglected)	$5.0 < L$	0	$0.3 < W$	—	0	
		Width (mm)	Length (mm)	Acceptable number															
		$W \leq 0.1$	—	(Neglected)															
		$0.1 < W \leq 0.3$	$L \leq 5.0$	(Neglected)															
	$5.0 < L$		0																
	$0.3 < W$	—	0																
	Polarizer (Bubble)	<table border="1"> <thead> <tr> <th>Size (mm)</th> <th>Acceptable number</th> </tr> </thead> <tbody> <tr> <td>$d \leq 0.2$</td> <td>(Neglected)</td> </tr> <tr> <td>$0.2 < d \leq 0.3$</td> <td>5</td> </tr> <tr> <td>$0.3 < d \leq 0.5$</td> <td>3</td> </tr> <tr> <td>$0.5 < d$</td> <td>0</td> </tr> </tbody> </table>			Size (mm)	Acceptable number	$d \leq 0.2$	(Neglected)	$0.2 < d \leq 0.3$	5	$0.3 < d \leq 0.5$	3	$0.5 < d$	0					
		Size (mm)	Acceptable number																
		$d \leq 0.2$	(Neglected)																
		$0.2 < d \leq 0.3$	5																
	$0.3 < d \leq 0.5$	3																	
	$0.5 < d$	0																	
Foreign particle (Circular shape)	<table border="1"> <thead> <tr> <th>Size (mm)</th> <th>Acceptable number</th> </tr> </thead> <tbody> <tr> <td>$d \leq 0.2$</td> <td>(Neglected)</td> </tr> <tr> <td>$0.2 < d \leq 0.4$</td> <td>5</td> </tr> <tr> <td>$0.4 < d \leq 0.5$</td> <td>3</td> </tr> <tr> <td>$0.5 < d$</td> <td>0</td> </tr> </tbody> </table>			Size (mm)	Acceptable number	$d \leq 0.2$	(Neglected)	$0.2 < d \leq 0.4$	5	$0.4 < d \leq 0.5$	3	$0.5 < d$	0						
	Size (mm)	Acceptable number																	
	$d \leq 0.2$	(Neglected)																	
	$0.2 < d \leq 0.4$	5																	
$0.4 < d \leq 0.5$	3																		
$0.5 < d$	0																		
Foreign particle (Linear shape) Scratch	<table border="1"> <thead> <tr> <th>Width (mm)</th> <th>Length (mm)</th> <th>Acceptable number</th> </tr> </thead> <tbody> <tr> <td>$W \leq 0.03$</td> <td>—</td> <td>(Neglected)</td> </tr> <tr> <td rowspan="3">$0.03 < W \leq 0.1$</td> <td>$L \leq 2.0$</td> <td>(Neglected)</td> </tr> <tr> <td>$2.0 < L \leq 4.0$</td> <td>3</td> </tr> <tr> <td>$4.0 < L$</td> <td>0</td> </tr> <tr> <td>$0.1 < W$</td> <td>—</td> <td>(According to circular shape)</td> </tr> </tbody> </table>			Width (mm)	Length (mm)	Acceptable number	$W \leq 0.03$	—	(Neglected)	$0.03 < W \leq 0.1$	$L \leq 2.0$	(Neglected)	$2.0 < L \leq 4.0$	3	$4.0 < L$	0	$0.1 < W$	—	(According to circular shape)
	Width (mm)	Length (mm)	Acceptable number																
	$W \leq 0.03$	—	(Neglected)																
	$0.03 < W \leq 0.1$	$L \leq 2.0$	(Neglected)																
		$2.0 < L \leq 4.0$	3																
$4.0 < L$		0																	
$0.1 < W$	—	(According to circular shape)																	