

TO-263-2L Plastic-Encapsulate Diodes

MBRB10100CT SCHOTTKY BARRIER RECTIFIER

FEATURE

- Schottky Barrier Chip
- Guard Ring Die Construction for Transient Protection
- Low Power Loss, High Efficiency
- High Surge Capability
- High Current Capability and Low Forward Voltage Drop
- For Use in Low Voltage, High Frequency Inverters, Free Wheeling, and Polarity Protection Applications

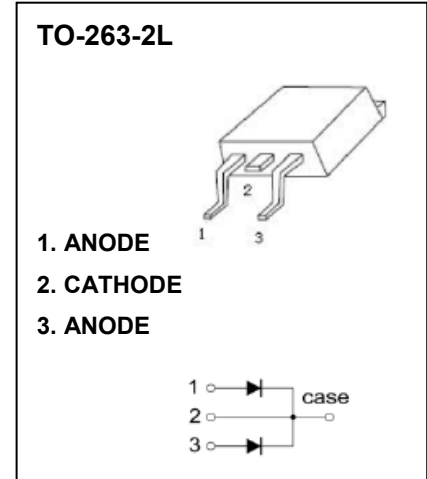

MAXIMUM RATINGS ($T_a=25^{\circ}\text{C}$ unless otherwise noted)

| Symbol | Parameter | Value | Unit |
|-----------------|---|----------|-----------------------------|
| V_{RRM} | Peak repetitive reverse voltage | 100 | V |
| V_{RWM} | Working peak reverse voltage | | |
| $V_{R(RMS)}$ | RMS reverse voltage | 70 | V |
| I_o | Average rectified output current | 10 | A |
| I_{FSM} | Non-repetitive peak forward surge current @8.3ms half sine wave | 120 | A |
| P_D | Power dissipation | 2 | W |
| $R_{\theta JA}$ | Thermal resistance from junction to ambient | 50 | $^{\circ}\text{C}/\text{W}$ |
| T_J | Junction temperature | 125 | $^{\circ}\text{C}$ |
| T_{stg} | Storage temperature | -55~+150 | $^{\circ}\text{C}$ |

ELECTRICAL CHARACTERISTICS ($T_a=25^{\circ}\text{C}$ unless otherwise specified)

| Parameter | Symbol | Test conditions | Min | Typ | Max | Unit |
|-------------------|--------------|--------------------------------|-----|-----|------|------|
| Reverse voltage | $V_{(BR)}$ | $I_R=0.1\text{mA}$ | 100 | | | V |
| Reverse current | I_R | $V_R=100\text{V}$ | | | 0.01 | mA |
| Forward voltage | $V_{F(1)}$ | $I_F=5\text{A}$ | | | 0.85 | V |
| | $V_{F(2)^*}$ | $I_F=10\text{A}$ | | | 0.95 | V |
| Total capacitance | C_{tot} | $V_R=4\text{V}, f=1\text{MHz}$ | | 90 | | pF |

*Pulse test

Typical Characteristics

Forward Characteristics

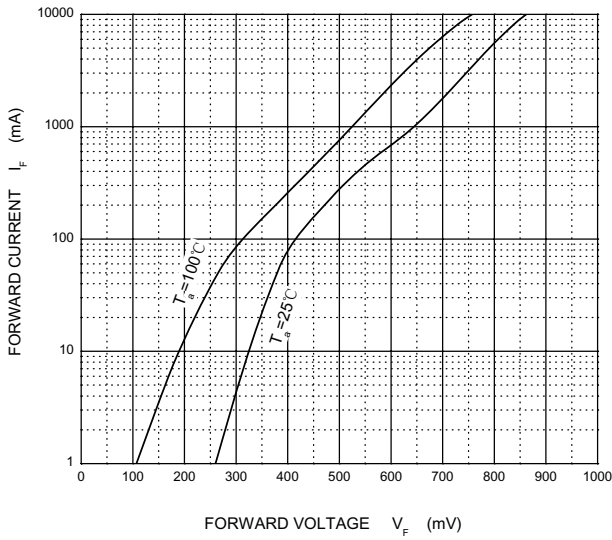

Reverse Characteristics

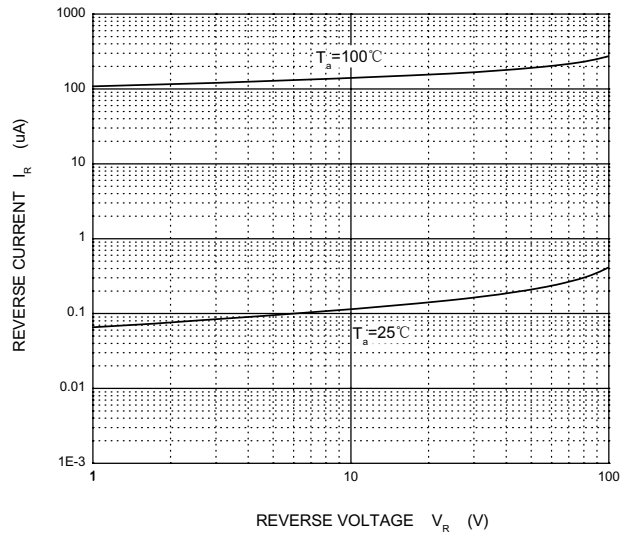

Capacitance Characteristics

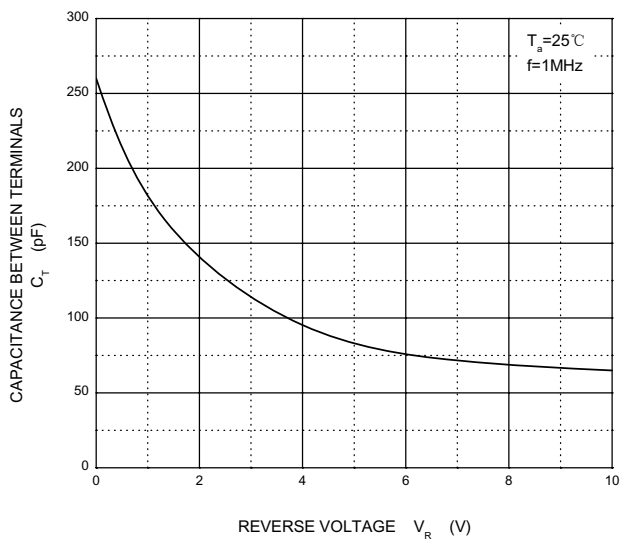

Power Derating Curve

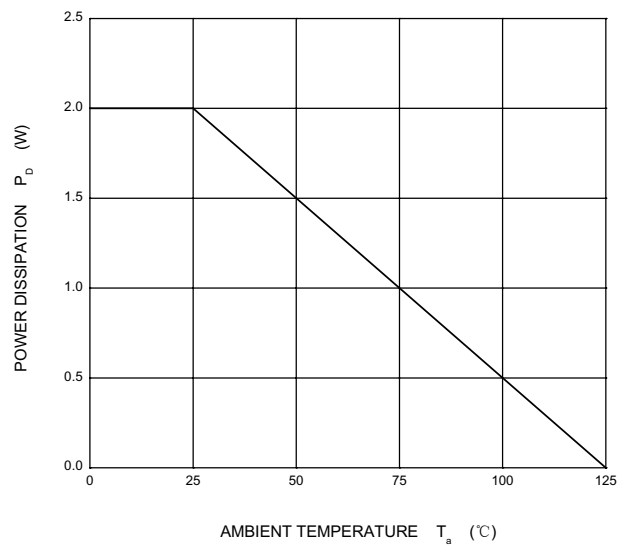

TO-263-2L Package Outline Dimensions

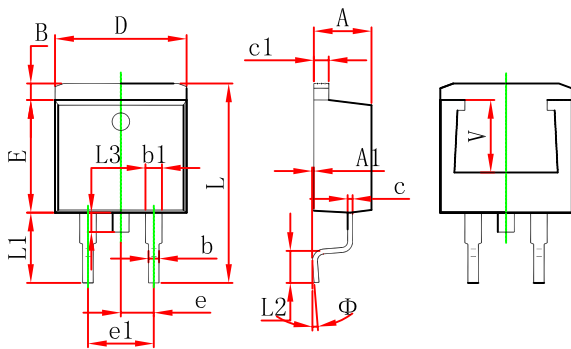

| Symbol | Dimensions In Millimeters | | Dimensions In Inches | |
|--------|---------------------------|--------|----------------------|-------|
| | Min. | Max. | Min. | Max. |
| A | 4.470 | 4.670 | 0.176 | 0.184 |
| A1 | 0.000 | 0.150 | 0.000 | 0.006 |
| B | 1.120 | 1.420 | 0.044 | 0.056 |
| b | 0.710 | 0.910 | 0.028 | 0.036 |
| b1 | 1.170 | 1.370 | 0.046 | 0.054 |
| c | 0.310 | 0.530 | 0.012 | 0.021 |
| c1 | 1.170 | 1.370 | 0.046 | 0.054 |
| D | 10.010 | 10.310 | 0.394 | 0.406 |
| E | 8.500 | 8.900 | 0.335 | 0.350 |
| e | 2.540 TYP. | | 0.100 TYP. | |
| e1 | 4.980 | 5.180 | 0.196 | 0.204 |
| L | 14.940 | 15.500 | 0.588 | 0.610 |
| L1 | 4.950 | 5.450 | 0.195 | 0.215 |
| L2 | 2.340 | 2.740 | 0.092 | 0.108 |
| L3 | 1.300 | 1.700 | 0.051 | 0.067 |
| Φ | 0° | | 8° | |
| V | 5.600 REF. | | 0.220 REF. | |

TO-263-2L Suggested Pad Layout

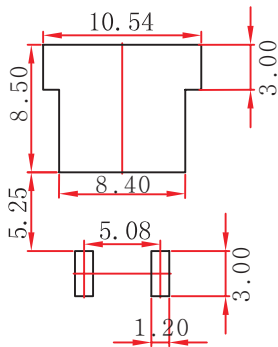

Note:

1. Controlling dimension: in millimeters.
2. General tolerance: ± 0.05 mm.
3. The pad layout is for reference purposes only.

NOTICE

JCET reserve the right to make modifications, enhancements, improvements, corrections or other changes without further notice to any product herein. JCET does not assume any liability arising out of the application or use of any product described herein.

TO-263-2L Tape and Reel

TO-263-2L Embossed Carrier Tape

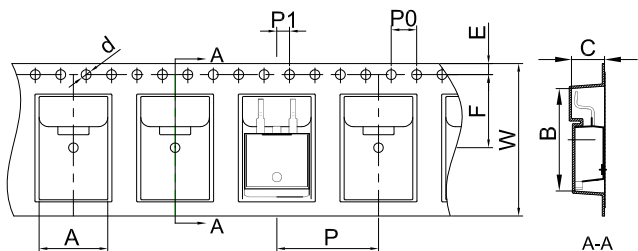

Packaging Description:
 TO-263-2L parts are shipped in tape. The carrier tape is made from a dissipative (carbon filled) polycarbonate resin. The cover tape is a multilayer film (Heat Activated Adhesive in nature) primarily composed of polyester film, adhesive layer, sealant, and anti-static sprayed agent. These reeled parts in standard option are shipped with 800 units per 13" or 33.0 cm diameter reel. The reels are clear in color and is made of polystyrene plastic (anti-static coated).

| Dimensions are in millimeter | | | | | | | | | | |
|------------------------------|-------|-------|------|-------|------|-------|------|-------|------|-------|
| Pkg type | A | B | C | d | E | F | P0 | P | P1 | W |
| TO-263-2L | 10.80 | 16.13 | 5.21 | Ø1.55 | 1.75 | 11.50 | 4.00 | 16.00 | 2.00 | 24.00 |

TO-263-2L Tape Leader and Trailer

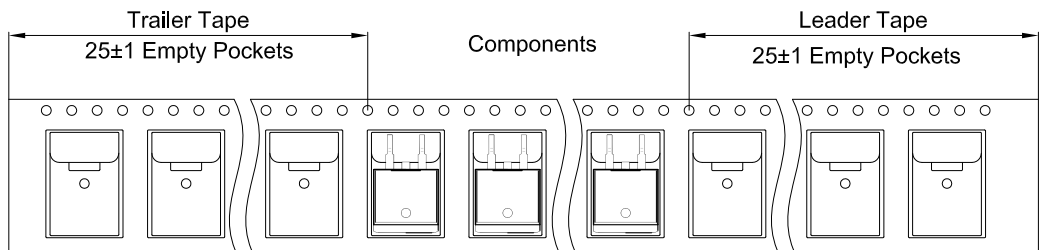

TO-263-2L Reel

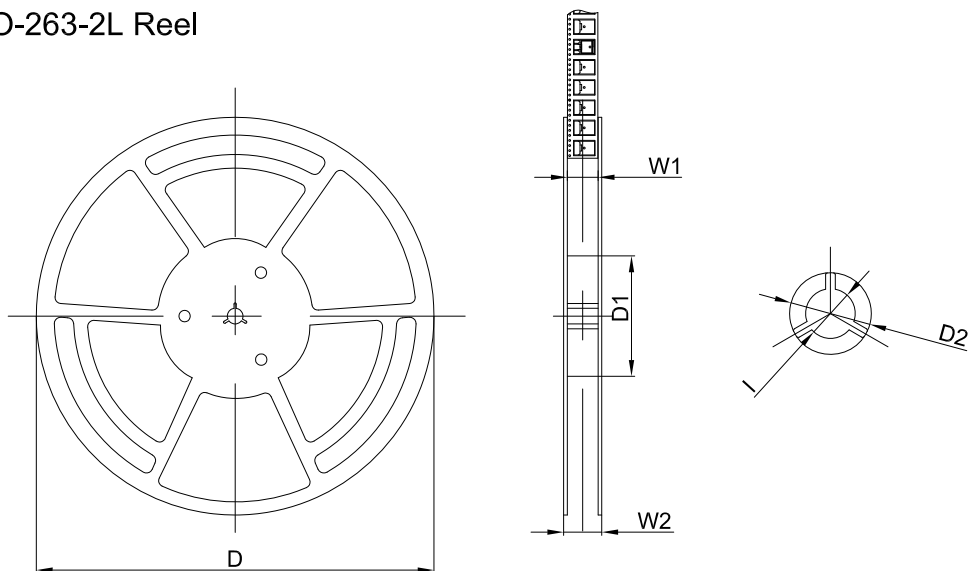

| Dimensions are in millimeter | | | | | | |
|------------------------------|---------|--------|--------|------|------|--------|
| Reel Option | D | D1 | D2 | W1 | W2 | I |
| 13"Dia | Ø330.00 | 100.00 | Ø21.00 | 24.4 | 30.4 | Ø13.00 |

| REEL | Reel Size | Box | Box Size(mm) | Carton | Carton Size(mm) | G.W.(kg) |
|---------|-----------|---------|--------------|-----------|-----------------|----------|
| 800 pcs | 13 inch | 800 pcs | 340×336×36 | 8,000 pcs | 400×353×365 | |