

LSP10GIHP Module Series

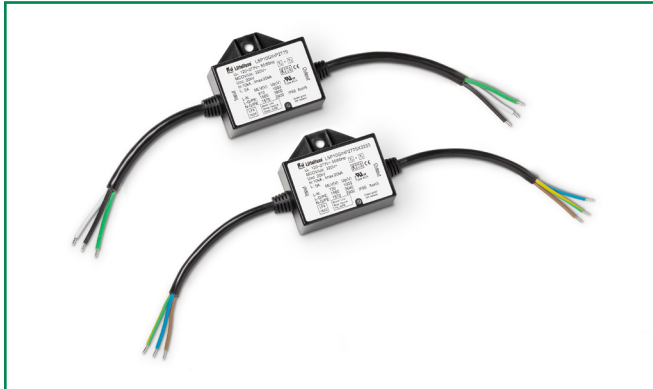



Description

The Littelfuse LSP10GIHP thermally protected Surge Protective Device is a self-protected device which is specially designed to be used in outdoor and commercial LED lighting fixtures for transient overvoltage protection. It is constructed with Littelfuse thermally protected varistor technology. Its built-in thermal disconnect function provides additional protection to prevent catastrophic failure and fire hazard even under the extreme circumstances of varistor end-of-life or sustaining over voltage conditions.

The LSP10GIHP provides coordinated surge protection with more LED drivers than other SPDs due to its exceptionally low Measured Limiting Voltage (MLV) and Voltage Protection Level (U_p). This lower clamping voltage can also help to extend the life-time of the luminaire. It also features a built-in LED indicator that notifies when replacement of the module is needed.

Agency Approvals

Agency	Standard	Agency File Number
	UL 1449	E320116
	IEC 61643-11/EN 61643-11 for 277V Product	3187362.01

Additional Information



Datasheet



Resources



Samples

Features

- Suitable for use in luminaire with Class I or Class II installations*
- Low MLV and U_p
- Built-in LED Indication, saves maintenance time by identifying replacement need
- Thermally Protected
- Double insulation cable wire
- 20kA Maximum Discharge Current (I_{max}), 8/20 μ s
- Meets ANSI C82.77-5-2015: Location C High
- Meets ANSI C136.2-2015: Extreme Level
- Meets IEEE C62.41.2: Location Category C High
- Meets US Dept. of Energy MSSSLC Model Spec.
- High line-to-earth/ground resistance
- IP66 - Dust-tight and water resistant
- Series connected
- UL 1449 and IEC 61643-11/EN 61643-11 recognized*
- RoHS compliant

* See [Part Numbering System](#) for exact details of voltages available for Class I and Class II installations and [Device Ratings and Specification](#) table for voltage specific approvals.

Applications

- Outdoor and Commercial LED Lighting
- Roadway lighting
- Traffic lighting
- Digital signage
- Wall wash lighting
- Parking garage/lot lighting
- Flood lighting
- Tunnel lighting
- Street lighting

Absolute Maximum Ratings

• For ratings of individual members of a series, see Device Ratings and Specifications chart

	LSP10GIHP Series	Units
Continuous:		
Steady State Applied Voltage:		
Max AC Voltage Range ($V_{MAC(RMS)}$)	150 to 510	V
Continuous Current	5	A
Transient:		
Maximum Discharge Current, 8/20 μ s Waveform (I_{max})	20,000	A
Nominal Discharge Current, 8/20 μ s Waveform (I_n)	10,000	A
Operating Ambient Temperature Range (T_A)	-45 to +75	°C
Storage Temperature Range (T_{STG})	-45 to +85	°C
Isolation Voltage Capability (When the thermal disconnect opens)	600	V
Insulation Resistance	>1,000	M Ω

CAUTION: Stresses above those listed in 'Absolute Maximum Ratings' may cause permanent damage to the device. This is a stress only rating and operation of the device at these or any other conditions above those indicated in the operational sections of this specification is not implied.

LSP10GIHP Series Device Ratings and Specifications

Part Number	Operating Voltage (VAC)	MCOV/ U_c ¹ (VAC)	Maximum Discharge Current ² I_{max} (A)	Nominal Discharge Current ³ I_n (A)	MLV ⁴ (V)	U_p ⁵ (V)	Safety Compliance	
							IEC/EN 61643-11	UL1449
LSP10GIHP277S	120-277	320	20,000	10,000	L-N: 810 L-G: 1560 N-G: 1570	L-N: 1000 L-G/PE: 3800 N-G/PE: 2900	X	X
LSP10GIHP480S	347-480	510	20,000	10,000	L-N: 1400 L-G: 1560 N-G: 1570	--	--	X

Glossary:

1. MCOV/ U_c : Maximum Continuous Operating Voltage - maximum r.m.s. voltage that could be continuously applied to the SPD.
2. Maximum Discharge Current I_{max} (A): The maximum discharge current is a measure of the SPDs maximum capability; single impulse of discharge current uses the 8/20 μ s current waveform. All Devices pass maximum discharge current with possible, safe opening of thermal disconnect.
3. Nominal Discharge Current I_n (A): The nominal discharge current is a measure of the SPDs endurance capability; 15 impulses of discharge current uses the 8/20 μ s current waveform.
4. MLV: UL1449 Measured limiting voltage; the highest value of residual voltage measurements during the application of impulses of 8/20 μ s nominal discharge current (I_n); an average voltage value of 15 impulses.
5. U_p : IEC 61643-11 Voltage protection level; the highest value of residual voltage measurements during the application of impulses of 8/20 μ s nominal discharge current (I_n); a rounding voltage value of maximum measurement.

Specification	Value	Condition
	120-277V	
Temporary Overvoltage (V) TOV UT @ $t_T = 5$ s	403	LV System Fault for TN Power Grid
Temporary Overvoltage (V) TOV UT @ $t_T = 120$ min	529	LV System Fault for TN Power Grid
Power grids	TN	
Backup fuse (A)	21	Maximum gG Fuse
End of life indication	Yes	Optical Light ON: SPD is functional Light OFF: SPD has reached end-of-life
Max earth leakage current at U_c (μ A)	50	
IEC 61643-11 Test Classification	Test Class II and III	
EN 61643-11 Type Classification	Type 2 and 3	
UL 1449 Type	4CA	

Repetitive Surge Capability

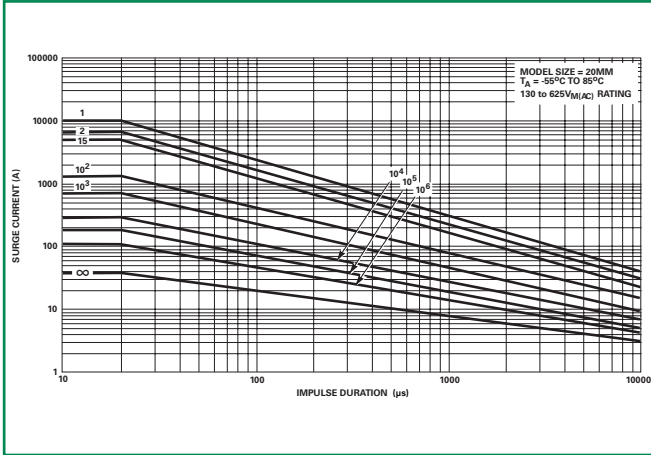

Pulse Rating (8x20µSec)	
Strikes	Surge
1	20,000A
2	15,000A
15	10,000A
100	3,000A
1,000	1,600A
1,0000	650A
1,00,000	400A
1,000,000	240A

LSP10GIHP Series Wire Specification

Part Number Extension	Length	Diameter	Double Insulation	Installation Class	Color
X3333	250mm ± 20mm	1mm ²	Yes	I	L - Brown N - Blue G/PE - Green with Yellow stripe
X3316	250mm ± 20mm	1mm ²	Yes	II	L - Brown N - Blue
None	250mm ± 20mm	16AWG	Yes	-	L - Black N - White G - Green

Dimensions

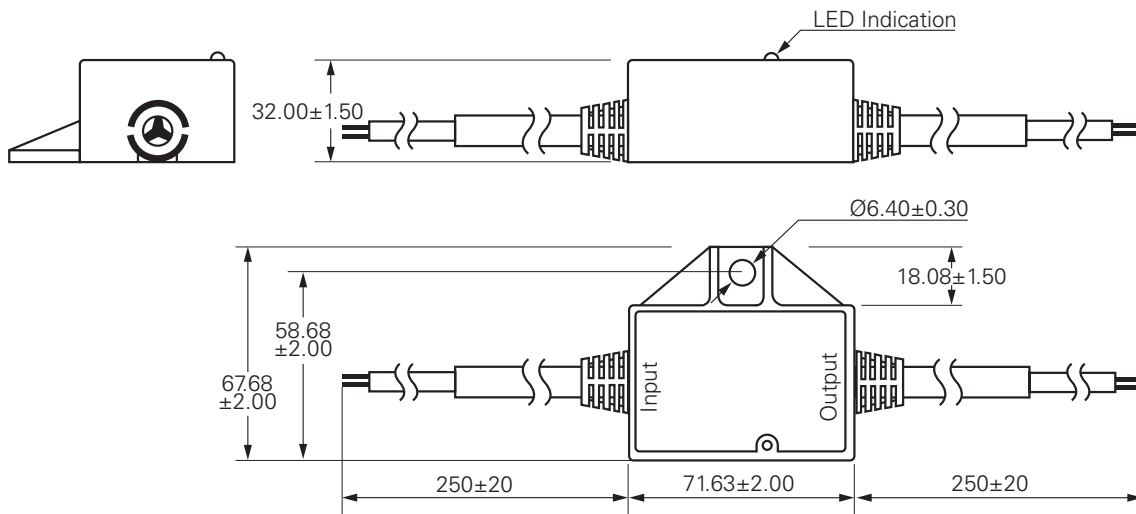

Note: Dimensions are in millimeter (mm)

Application/Installation Schematic

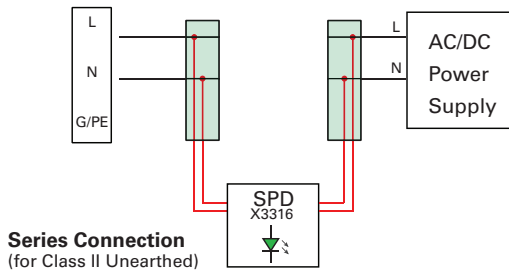
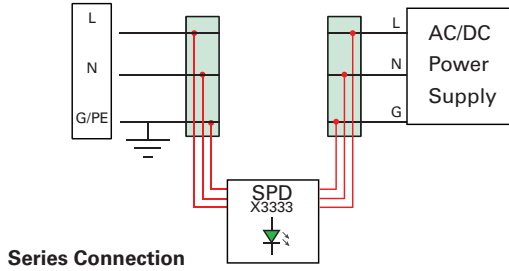

Notes:

1. Green LED light on: SPD is good
2. Green LED light off: SPD needs replacement

Part Numbering System

