

SIT1630

Ultra-Low Power, Ultra-Small 32.768 kHz or 16.384 kHz Oscillator



Features

- <20 ppm initial tolerance
- <100 ppm stability over -40°C to +85°C
- Small SMD package: 2.0 x 1.2 mm (2012)^[1]
- SOT23-5 package option for industrial and automotive applications
- Ultra-low power: 1.0 μ A typ
- Vdd supply range: 1.5V to 3.63V
- Wide operating temperature range options
- Internal filtering eliminates external Vdd bypass capacitors
- Pb-free, RoHS and REACH compliant

Applications

- Industrial timekeeping
- Industrial battery management
- Multi-drop 32 kHz clock distribution
- Bluetooth modules
- WiFi modules
- RTC Reference Clock



Note:

1. For the smallest 32 kHz XO in CSP (1.2mm²), consider the [SIT1532](#).

Table 1. Electrical Characteristics

Parameter	Symbol	Min.	Typ.	Max.	Unit	Condition
Frequency and Stability						
Output Frequency	F _{out}	32.768 or 16.384			kHz	
Frequency Stability						
Initial Tolerance ^[2]	F _{init}			20	ppm	T _A = 25°C, post reflow, Vdd: 1.5V – 3.63V.
Frequency Stability Over Temperature ^[3]	F _{stab}			75	ppm	T _A = -10°C to +70°C, Vdd: 1.5V – 3.63V.
				100		T _A = -40°C to +85°C, Vdd: 1.5V – 3.63V.
				150		T _A = -40°C to +105°C, -55°C to +85°C, Vdd: 1.8V – 3.63V.
25°C Aging		-1		1	ppm	1st Year
Supply Voltage and Current Consumption						
Operating Supply Voltage	Vdd	1.5		3.63	V	T _A = over temperature
Operating Current	I _{dd}		1.0		μ A	T _A = 25°C, Vdd: 1.5V – 3.3V. No load
				1.3		T _A = -10°C to +70°C, Vdd max: 3.63V. No load
				1.4		T _A = -40°C to +85°C, Vdd max: 3.63V. No load
				2.80		T _A = -40°C to +105°C, Vdd max: 3.63V. No load
Power-Supply Ramp	t _{Vdd Ramp}			100	ms	Over temperature, 0 to 90% Vdd
Start-up Time at Power-up	T _{start}		180	300	ms	-40°C ≤ T _A ≤ 50°C, valid output
				450		-40°C ≤ T _A ≤ 85°C, valid output
				500 + 1 period		T _A = -55°C and +105°C
Operating Temperature Range						
Commercial Temperature	T _{opn}	-10		70	°C	Temp code "C" in part number ordering
Industrial Temperature		-40		85		Temp code "I" in part number ordering
Extended Industrial Temperature		-40		105		Temp code "E" in part number ordering.
Extended Cold Industrial Temperature		-55		85		Temp Code "D" in part number ordering.
Automotive Temperature Range		-55		105		Contact Factory for Availability
LVC MOS Output, T_A = Over Temperature, typical values are at T_A = 25°C						
Output Rise/Fall Time	t _r , t _f		100	200	ns	10-90%, 15 pF load, Vdd = 1.5V to 3.63V 10-90% (Vdd), 5 pF load, Vdd ≥ 1.62V
Output Clock Duty Cycle	DC	48		52	%	
Output Voltage High	VOH	90%			V	Vdd: 1.5V – 3.63V. I _{OH} = -10 μ A, 15 pF
Output Voltage Low	VOL			10%	V	Vdd: 1.5V – 3.63V. I _{OL} = 10 μ A, 15 pF
Maximum Output Drive				50	pF	≥80% LVC MOS swing, T _A = over temperature, Vdd = 1.5V to 3.3V
Period Jitter	T _{jitt}		35		ns _{RMS}	Cycles = 10,000, T _A = 25°C

Notes:

2. Measured peak-to-peak. Tested with Agilent 53132A frequency counter. Due to the low operating frequency, the gate time must be ≥100 ms to ensure an accurate frequency measurement.
3. Measured peak-to-peak. Inclusive of Initial Tolerance at 25°C, and variations over operating temperature, rated power supply voltage and load.

Table 2. Pin Configuration

SMD Pin	SOT23-5 Pin	Symbol	I/O	Functionality
1	2, 3	NC/GND	No Connect	Connect to GND or leave floating.
2	1	GND	Power Supply Ground	Connect to ground. All GND pins must be connected to power supply ground.
3	5	CLK Out	OUT	Oscillator clock output. When interfacing to an MCU's XTAL input, the CLK Out is typically connected to the receiving IC's X IN pin.
4	4	Vdd	Power Supply	Connect to power supply $1.5V \leq Vdd \leq 3.63V$. Under normal operating conditions, Vdd does not require external bypass/decoupling capacitor(s). Internal power supply filtering will reject more than ± 150 mVpp with frequency components through 10 MHz.

SOT23-5 (Top View)

SMD Package (Top View)

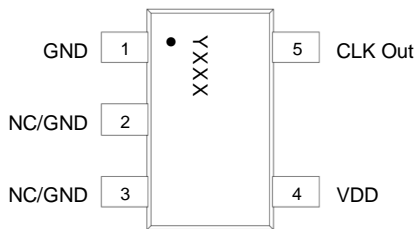

Figure 1. Pin Assignments

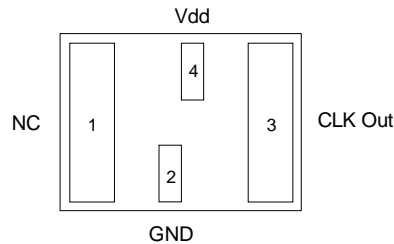

Figure 2. Pin Assignments

System Block Diagram

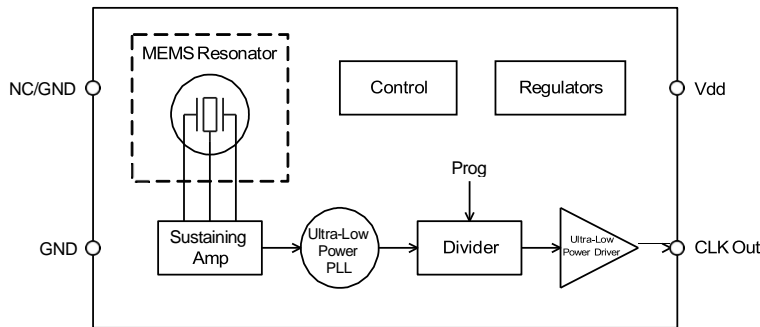

Figure 3. SIT1630 Block Diagram

Table 3. Absolute Maximum

Attempted operation outside the absolute maximum ratings cause permanent damage to the part. Actual performance of the IC is only guaranteed within the operational specifications, not at absolute maximum ratings.

Parameter	Test Condition	Value	Unit
Continuous Power Supply Voltage Range (Vdd)		-0.5 to 3.63	V
Short Duration Maximum Power Supply Voltage (Vdd)	≤30 minutes, over -40°C to +85°C	4.0	V
Short Duration Maximum Operating Temperature Range	Vdd = 1.5V - 3.63V, ≤30 mins	125	°C
Maximum Continuous Operating Life at Temperature Extreme (meeting datasheet limits)	T _A = -55°C, Continuous Vdd = 1.8V - 3.3V ±10%	8	Hours
Human Body Model ESD Protection	JESD22-A114	3000	V
Charge-Device Model (CDM) ESD Protection	JESD22-C101	750	V
Machine Model (MM) ESD Protection	JESD22-A115	300	V
Latch-up Tolerance	JESD78 Compliant		
Mechanical Shock Resistance	Mil 883, Method 2002	10,000	g
Mechanical Vibration Resistance	Mil 883, Method 2007	70	g
2012 SMD Junction Temperature		150	°C
SOT23-5 Junction Temperature		150	°C
Storage Temperature		-65°C to 150°C	

Description

The SiT1630 is an ultra-small and ultra-low power 32.768 kHz oscillator optimized for battery-powered applications.

SiTime’s MEMS oscillators consist of MEMS resonators and a programmable analog circuit. Our MEMS resonators are built with SiTime’s unique MEMS First™ process. A key manufacturing step is EpiSeal™ during which the MEMS resonator is annealed with temperatures over 1000°C. EpiSeal creates an extremely strong, clean, vacuum chamber that encapsulates the MEMS resonator and ensures the best performance and reliability. During EpiSeal, a poly silicon cap is grown on top of the resonator cavity, which eliminates the need for additional cap wafers or other exotic packaging. As a result, SiTime’s MEMS resonator die can be used like any other semiconductor die. One unique result of SiTime’s MEMS First and EpiSeal manufacturing processes is the capability to integrate SiTime’s MEMS die with a SOC, ASIC, microprocessor or analog die within a package to eliminate external timing components and provide a highly integrated, smaller, cheaper solution to the customer.

Frequency Stability

The SiT1630 is factory calibrated (trimmed) to guarantee frequency stability to be less than 20 ppm at room temperature and very tight stability over temperature. Unlike quartz crystals that have a classic tuning fork parabola temperature curve with a 25°C turnover point, the SiT1630 temperature coefficient is extremely flat across temperature.

When measuring the SiT1630 output frequency with a frequency counter, it is important to make sure the counter's gate time is >100 ms. The slow frequency of a 32 kHz clock will give false readings with faster gate times.

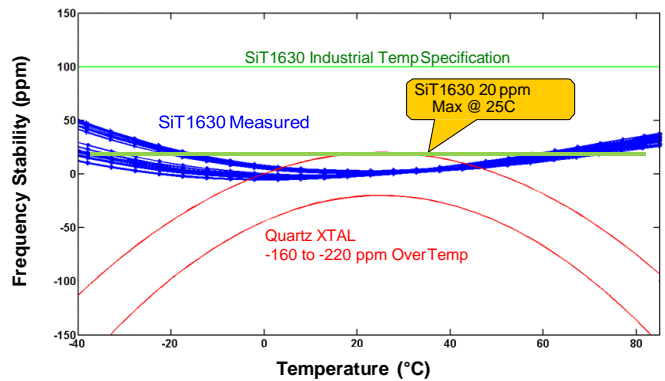

Figure 4. SiTime vs. Quartz

Power Supply Noise Immunity

The SiT1630 is an ultra-small 32 kHz oscillator. In addition to eliminating external output load capacitors common with standard XTALs, this device includes special power supply filtering and thus, eliminates the need for an external Vdd bypass-decoupling capacitor. This feature further simplifies the design and keeps the footprint as small as possible. Internal power supply filtering is designed to reject AC-noise greater than ±150 mVpp magnitude and beyond 10 MHz frequency component.

Power-up

The SiT1630 starts-up to a valid output frequency within 300 ms (180 ms typ). To ensure the device starts-up within the specified limit, make sure the power-supply ramps-up in approximately 10 – 20 ms (to within 90% of Vdd).

Typical Operating Curves

($T_A = 25^\circ\text{C}$, $V_{dd} = 1.8\text{V}$, unless otherwise stated)

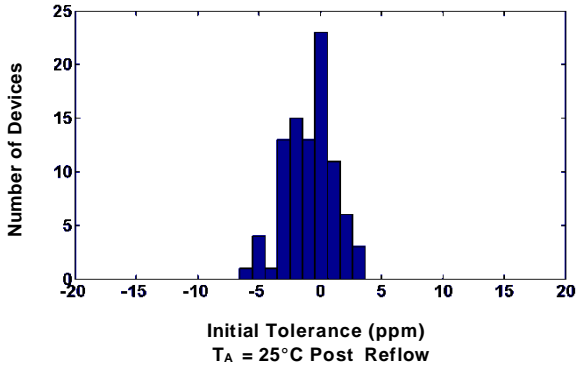

Figure 5. Initial Tolerance Histogram

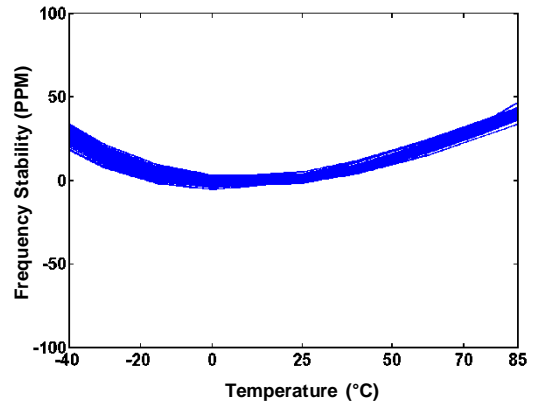

Figure 6. Frequency Stability Over Temperature

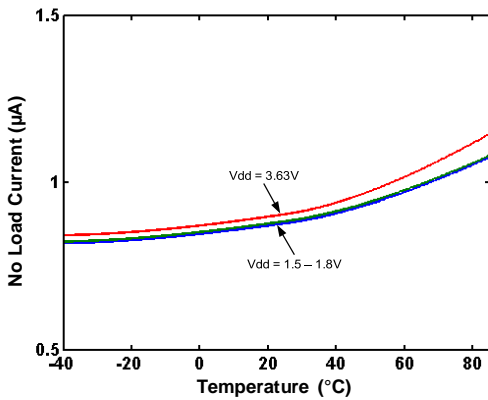

Figure 7. Supply Current Over Temperature (No Load)

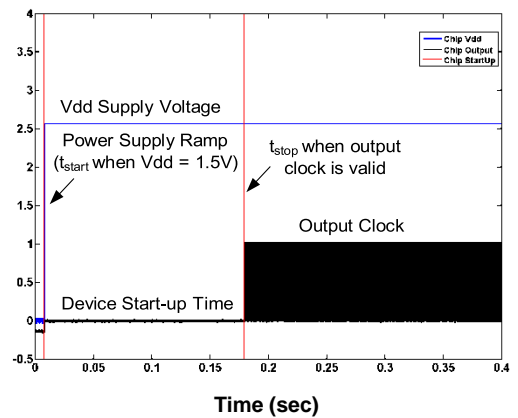

Figure 8. Start-up Time

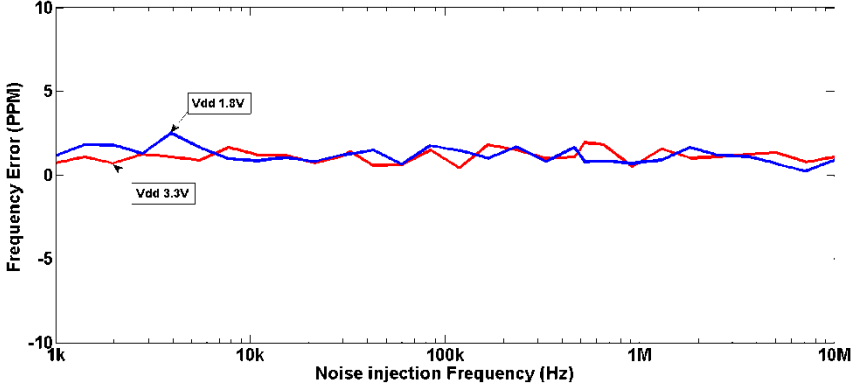

Figure 9. Power Supply Noise Rejection ($\pm 150\text{mV}$ Noise)

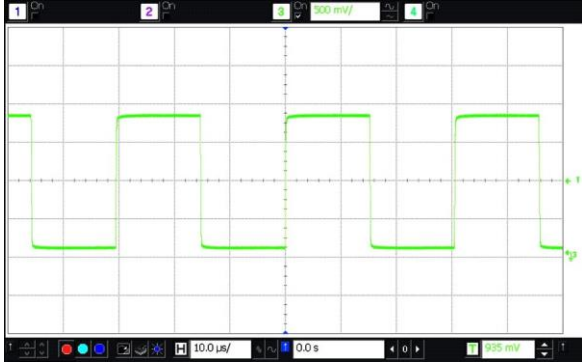

Figure 10. LVC MOS Output Waveform (Vswing = 1.8V, SiT1630AI-H4-DCC-32.768)

Table 4. Dimensions and Patterns

Package Size – Dimensions (Unit: mm)	Recommended Land Pattern (Unit: mm)
<p>2.0 x 1.2 mm SMD</p>	
<p>2.90 x 2.80 mm SOT23-5</p>	

Table 5. SOT23-5 Dimension Table

Symbol	Min.	Nom.	Max.
A	0.90	1.27	1.45
A1	0.00	0.07	0.15
A2	0.90	1.20	1.30
b	0.30	0.35	0.50
c	0.14	0.15	0.20
D	2.75	2.90	3.05
E	2.60	2.80	3.00
E1	1.45	1.60	1.75
L	0.30	0.38	0.55
L1	0.25 REF		
e	0.95 BSC.		
e1	1.90 BSC.		
α	0°	–	8°

Manufacturing Guidelines

- 1) No Ultrasonic Cleaning. Do not subject the SiT1630 to an ultrasonic cleaning environment. Permanent damage or long term reliability issues to the MEMS structure may occur.
- 2) For Noisy, high EM environments, we recommend the following design guidelines:
 - Place oscillator as far away from EM noise sources as possible (e.g., high-voltage switching regulators, motor drive control).
 - Route noisy PCB traces, such as digital data lines or high di/dt power supply lines, away from the SiTime oscillator.
 - Add a low ESR/ESL, 0.1uF to 1.0uF ceramic capacitor (X7R) to help filter high frequency noise on the Vdd power-supply line. Place it as close to the SiTime oscillator Vdd pin as possible.
 - Place a solid GND plane underneath the SiTime oscillator to shield the oscillator from noisy traces on the other board layers.
- 3) For additional manufacturing guidelines and marking/tape-reel instructions, click on the following link:
http://www.sitime.com/component/docman/doc_download/243-manufacturing-notes-for-sitime-oscillators

Ordering Information

Part number characters in blue represent the customer specific options. The other characters in the part number are fixed.

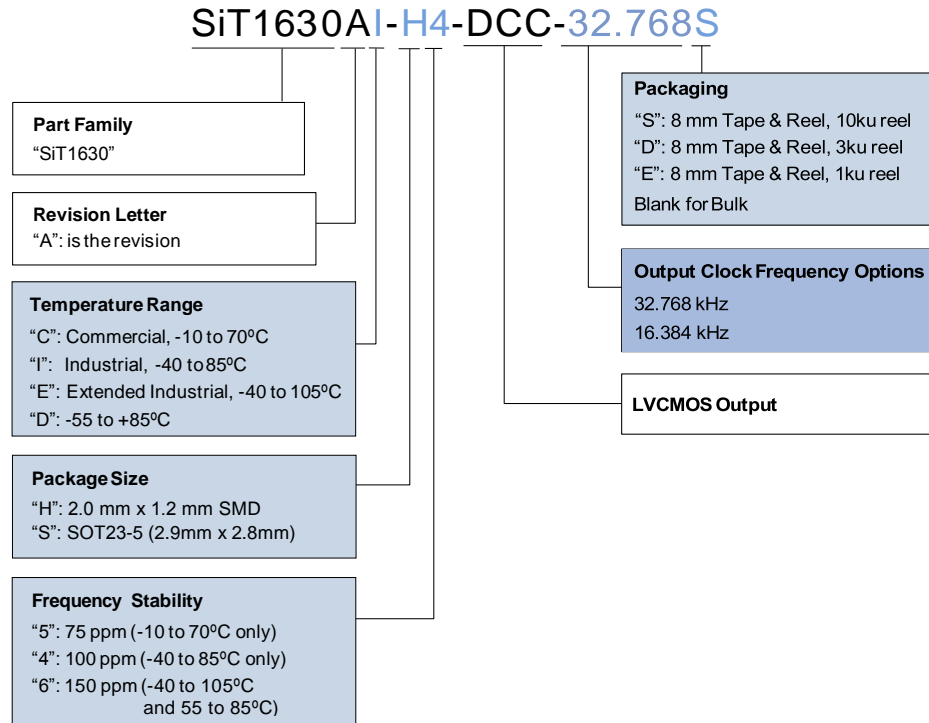

Table 6. Revision History

Version	Release Date	Change Summary
1.0	09/03/2014	Rev 0.85 Preliminary to Rev 1.0 Production Release <ul style="list-style-type: none"> ▪ Updated start-up time specification ▪ Deleted SOT23 package option ▪ Added typical operating plots ▪ Added maximum output drive specification ▪ Added <i>Manufacturing Guidelines</i> section
1.1	09/03/2014	<ul style="list-style-type: none"> ▪ Updated start-up time plot in <i>Typical Operating Curves</i> section ▪ Updated start-up time specification
1.2	11/10/2014	<ul style="list-style-type: none"> ▪ Added additional design-in/mfg guidelines
1.3	03/06/2017	<ul style="list-style-type: none"> ▪ Added SOT23-5 package option ▪ Improved max supply current for commercial and industrial temp ranges ▪ Improved max start-up time at 85°C ▪ Updated start-up time temperature range conditions

SiTime Corporation, 5451 Patrick Henry Drive, Santa Clara, CA 95054, USA | Phone: +1-408-328-4400 | Fax: +1-408-328-4439

© SiTime Corporation 2016-2017. The information contained herein is subject to change at any time without notice. SiTime assumes no responsibility or liability for any loss, damage or defect of a Product which is caused in whole or in part by (i) use of any circuitry other than circuitry embodied in a SiTime product, (ii) misuse or abuse including static discharge, neglect or accident, (iii) unauthorized modification or repairs which have been soldered or altered during assembly and are not capable of being tested by SiTime under its normal test conditions, or (iv) improper installation, storage, handling, warehousing or transportation, or (v) being subjected to unusual physical, thermal, or electrical stress.

Disclaimer: SiTime makes no warranty of any kind, express or implied, with regard to this material, and specifically disclaims any and all express or implied warranties, either in fact or by operation of law, statutory or otherwise, including the implied warranties of merchantability and fitness for use or a particular purpose, and any implied warranty arising from course of dealing or usage of trade, as well as any common-law duties relating to accuracy or lack of negligence, with respect to this material, any SiTime product and any product documentation. Products sold by SiTime are not suitable or intended to be used in a life support application or component, to operate nuclear facilities, or in other mission critical applications where human life may be involved or at stake. All sales are made conditioned upon compliance with the critical uses policy set forth below.

CRITICAL USE EXCLUSION POLICY

BUYER AGREES NOT TO USE SITIME'S PRODUCTS FOR ANY APPLICATION OR IN ANY COMPONENTS USED IN LIFE SUPPORT DEVICES OR TO OPERATE NUCLEAR FACILITIES OR FOR USE IN OTHER MISSION-CRITICAL APPLICATIONS OR COMPONENTS WHERE HUMAN LIFE OR PROPERTY MAY BE AT STAKE.

SiTime owns all rights, title and interest to the intellectual property related to SiTime's products, including any software, firmware, copyright, patent, or trademark. The sale of SiTime products does not convey or imply any license under patent or other rights. SiTime retains the copyright and trademark rights in all documents, catalogs and plans supplied pursuant to or ancillary to the sale of products or services by SiTime. Unless otherwise agreed to in writing by SiTime, any reproduction, modification, translation, compilation, or representation of this material shall be strictly prohibited.