



Technical Data
Data Sheet N0763, Rev. -

Green Products

MBR20200CT/MBRB20200CT/MBR20200CT-1
SCHOTTKY RECTIFIER

Applications:

- Switching power supply
- Converters
- Free-Wheeling diodes
- Reverse battery protection

Features:

- 175 °C T_J operation
- Center tap configuration
- Low forward voltage drop
- High purity, high temperature epoxy encapsulation for enhanced mechanical strength and moisture resistance
- High frequency operation
- Guard ring for enhanced ruggedness and long term reliability
- This is a Pb – Free Device
- All SMC parts are traceable to the wafer lot
- Additional testing can be offered upon request

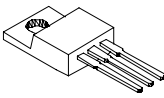
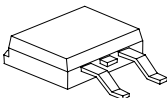
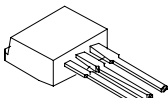
Case styles		
MBR20200CT	MBRB20200CT	MBR20200CT-1
		
TO-220AB	D²PAK	TO-262

Mechanical Dimensions: In Inches / mm

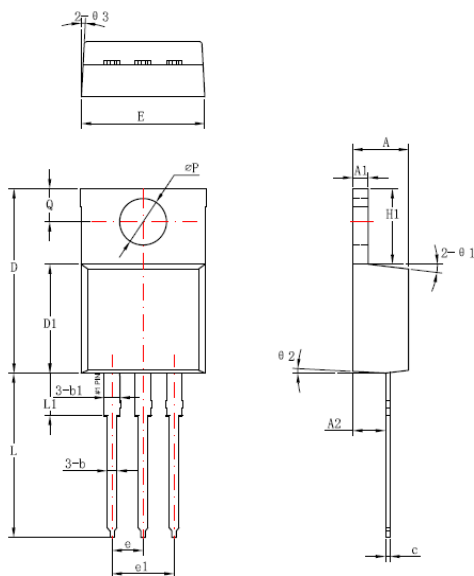

Symbol	Dimensions in millimeters		
	Min	Typical	Max
A	4.42	4.57	4.72
A1	1.17	1.27	1.37
A2	2.59	2.69	2.89
b	0.71	0.81	0.96
b1		1.27	
c	0.36	0.38	0.61
D	14.94	15.24	15.54
D1	8.85	9.00	9.15
E	10.01	10.16	10.31
e		2.54	
e1		5.06	
H1	6.04	6.24	6.44
L	12.7	13.56	13.78
L1		3.5	
ΦP	3.74	3.84	4.04
Q	2.54	2.74	2.94
θ1		7°	
θ2		3°	
θ3		4°	

TO-220AB

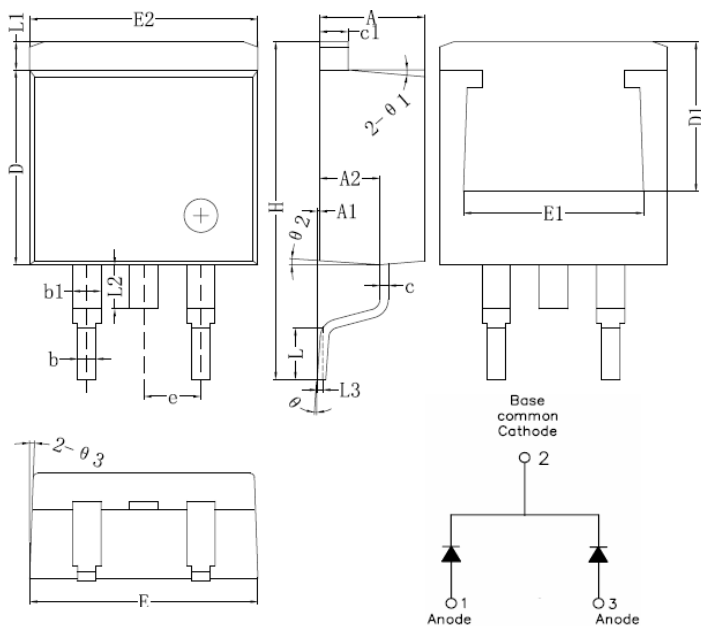

D²PAK

Symbol	Dimensions in millimeters		
	Min.	Typical	Max.
A	4.55	4.70	4.85
A1	0	0.10	0.25
A2	2.59	2.69	2.89
b	0.71	0.81	0.96
b1		1.27	
c	0.36	0.38	0.61
c1	1.17	1.27	1.37
D	8.55	8.70	8.85
D1	6.40		
E	10.01	10.16	10.31
E1	7.6		
E2	9.98	10.08	10.18
e		2.54	
H	14.6	15.1	15.6
L	2.00	2.30	2.70
L1	1.17	1.27	1.40
L2			2.20
L3		0.25BSC	
e	0	-	8°
e1		5°	
e2		4°	
e3		4°	

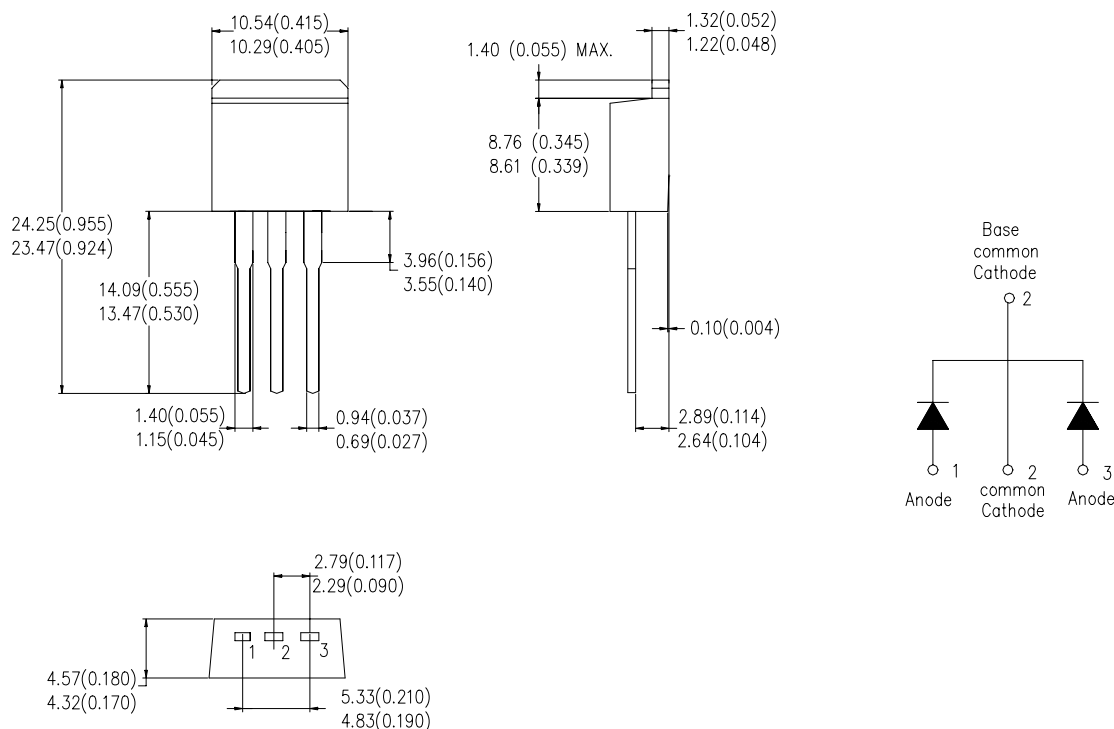

TO-262



Marking Diagram:

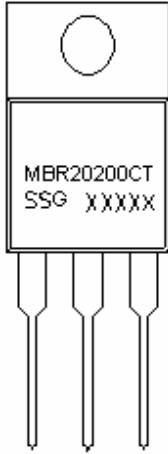

MBR20200CT

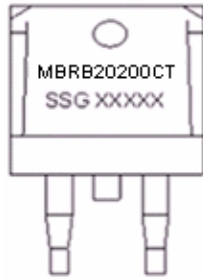

MBRB20200CT

Where XXXXX is YYWWL

MBR = Device Type
B = Package type
20 = Forward Current (20A)
200 = Reverse Voltage (200V)
CT/CT-1 = Configuration
SSG = SSG
YY = Year
WW = Week
L = Lot Number

Cautions: Molding resin
Epoxy resin UL:94V-0

Ordering Information:

Device	Package	Shipping
MBR20200CT	TO-220AB (Pb-Free)	50pcs / tube
MBRB20200CT	D ² PAK (Pb-Free)	800pcs / reel

For information on tape and reel specifications, including part orientation and tape sizes, please refer to our Tape and Reel Packaging Specification.

Maximum Ratings:

Characteristics	Symbol	Condition	Max.	Units
Peak Inverse Voltage	V_{RWM}	-	200	V
Maximum RMS Voltage	V_{RMS}	-	140	V
Max. Average Forward	$I_{F(AV)}$	50% duty cycle @ $T_C = 125^\circ C$, rectangular wave form	10(Per leg) 20(Per device)	A
Peak Repetitive Surge current (Rated V_R , Square Wave, 20KHz)	I_{RRM}	-	0.5	A
Max. Peak One Cycle Non-Repetitive Surge Current (per leg)	I_{FSM}	8.3 ms, half Sine pulse	180	A

Electrical Characteristics:

Characteristics	Symbol	Condition	Max.	Units
Max. Forward Voltage Drop (per leg)*	V _{F1}	@ 10A, Pulse, T _J = 25 °C	0.90	V
	V _{F2}	@ 10A, Pulse, T _J = 125 °C	0.80	V
Max. Reverse Current (per leg)*	I _{R1}	@V _R = rated V _R T _J = 25 °C	1.00	mA
	I _{R2}	@V _R = rated V _R T _J = 125 °C	50	mA
Max. Junction Capacitance (per leg)	C _T	@V _R = 5V, T _C = 25 °C f _{SIG} = 1MHz	500	pF
Typical Series Inductance (per leg)	L _S	Measured lead to lead 5 mm from package body	8.0	nH
Max. Voltage Rate of Change	dv/dt	-	10,000	V/μs

* Pulse Width < 300μs, Duty Cycle <2%

Thermal-Mechanical Specifications:

Characteristics	Symbol	Condition	Specification	Units
Max. Junction Temperature	T _J	-	-55 to +175	°C
Max. Storage Temperature	T _{stg}	-	-55 to +150	°C
Maximum Thermal Resistance Junction to Case (per leg)	R _{θJC}	DC operation	1.5	°C/W
Approximate Weight	wt	-	2	g
Case Style	TO-220AB/D ² PAK/TO-262			

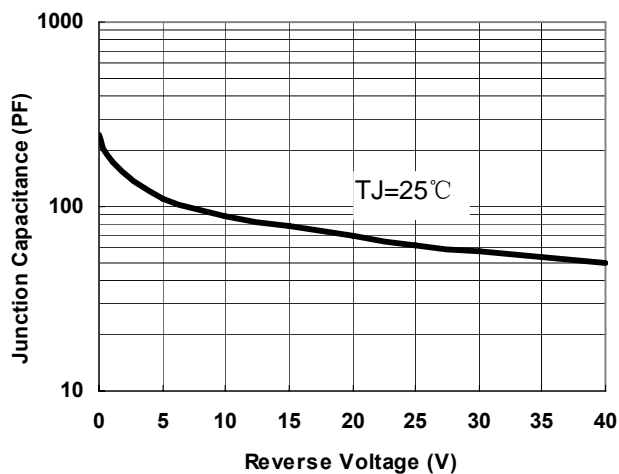

Fig.1-Typical Junction Capacitance

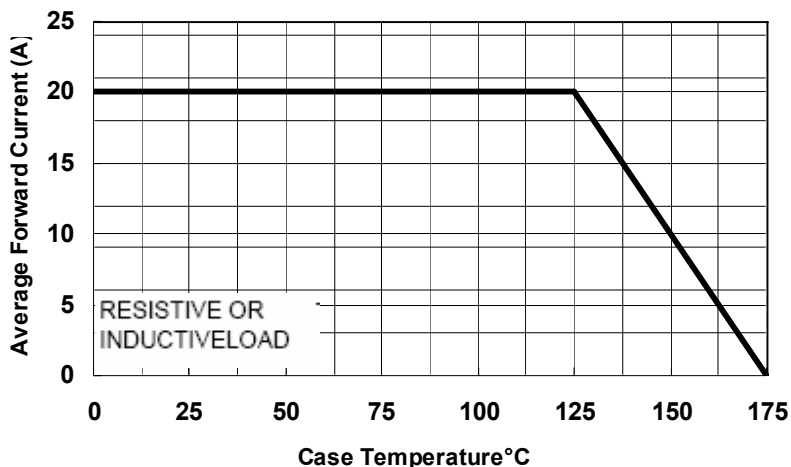

Fig.2-Forward current derating curve

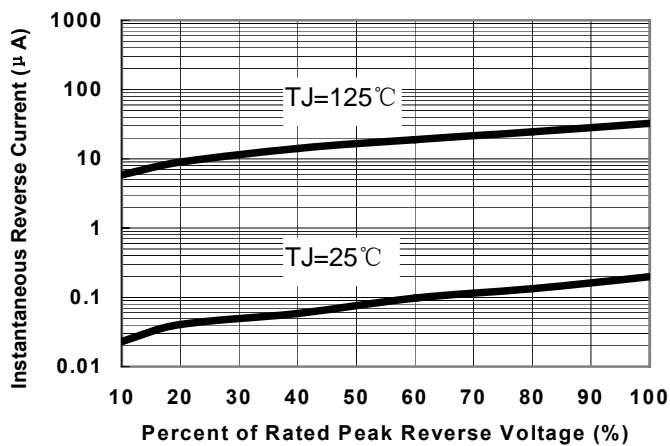

Fig.3-Typical Reverse Characteristics

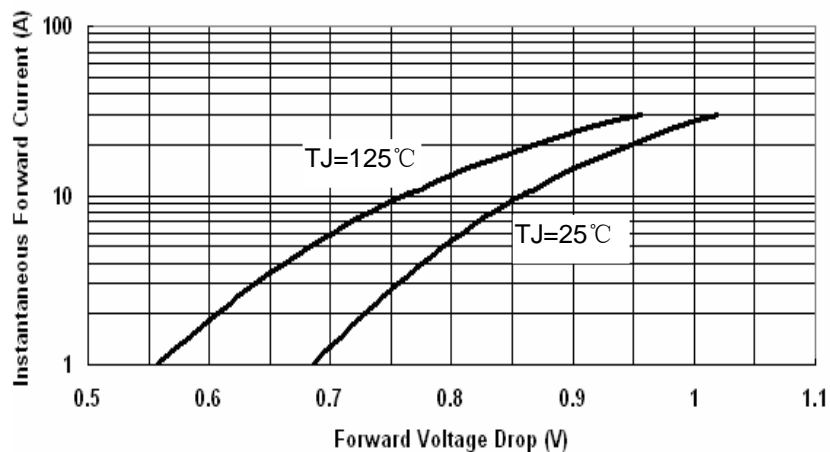

Fig.4-Typical Instantaneous Forward Voltage Characteristics

DISCLAIMER:

1- The information given herein, including the specifications and dimensions, is subject to change without prior notice to improve product characteristics. Before ordering, purchasers are advised to contact the SMC - Sangdest Microelectronics (Nanjing) Co., Ltd sales department for the latest version of the datasheet(s).

2- In cases where extremely high reliability is required (such as use in nuclear power control, aerospace and aviation, traffic equipment, medical equipment, and safety equipment), safety should be ensured by using semiconductor devices that feature assured safety or by means of users' fail-safe precautions or other arrangement.

3- In no event shall SMC - Sangdest Microelectronics (Nanjing) Co., Ltd be liable for any damages that may result from an accident or any other cause during operation of the user's units according to the datasheet(s). SMC - Sangdest Microelectronics (Nanjing) Co., Ltd assumes no responsibility for any intellectual property claims or any other problems that may result from applications of information, products or circuits described in the datasheets.

4- In no event shall SMC - Sangdest Microelectronics (Nanjing) Co., Ltd be liable for any failure in a semiconductor device or any secondary damage resulting from use at a value exceeding the absolute maximum rating.

5- No license is granted by the datasheet(s) under any patents or other rights of any third party or SMC - Sangdest Microelectronics (Nanjing) Co., Ltd.

6- The datasheet(s) may not be reproduced or duplicated, in any form, in whole or part, without the expressed written permission of SMC - Sangdest Microelectronics (Nanjing) Co., Ltd.

7- The products (technologies) described in the datasheet(s) are not to be provided to any party whose purpose in their application will hinder maintenance of international peace and safety nor are they to be applied to that purpose by their direct purchasers or any third party. When exporting these products (technologies), the necessary procedures are to be taken in accordance with related laws and regulations..