

Dual, 2-Phase, Synchronous Controller with Low Value DCR Sensing and Temperature Compensation

FEATURES

- Low Value DCR Current Sensing
- Programmable DCR Temperature Compensation
- $\pm 0.5\%$ 0.6V Output Voltage Accuracy
- Dual True Remote Sensing Differential Amplifiers
- Optional Fast Transient Operation
- Phase-Lockable Fixed Frequency 250kHz to 720kHz
- Dual, 180° Phased Controllers Reduce Required Input Capacitance and Power Supply Induced Noise
- Dual N-Channel MOSFET Synchronous Drive
- Wide V_{IN} Range: 4.5V to 38V Operation
- Output Voltage Range with Low DCR: 0.6V to 3.5V, without Low DCR: 0.6V to 5V
- Adjustable Soft-Start Current Ramping or Tracking
- Foldback Output Current Limiting
- Clock Input and Output for Up to 12-Phase Operation
- Short-Circuit Soft Recovery
- Output Overvoltage Protection
- Power Good Output Voltage Monitor
- 40-Lead QFN Packages

APPLICATIONS

- Servers and Instruments
- Telecom Systems
- DC Power Distribution Systems

DESCRIPTION

The **LTC[®]3875** is a dual output current mode synchronous step-down DC/DC controller that drives all N-channel synchronous power MOSFET stages. It employs a unique architecture which enhances the signal-to-noise ratio of the current sense signal, allowing the use of very low DC resistance power inductors to maximize the efficiency in high current applications. This feature also reduces the switching jitter commonly found in low DCR applications.

The LTC3875 features two high speed remote sense differential amplifiers, programmable current sense limits from 10mV to 30mV and DCR temperature compensation to limit the maximum output current precisely over temperature.

A unique thermal balancing function adjusts per phase current in order to minimize the thermal stress for multichip single output applications. The LTC3875 also features a precise 0.6V reference with guaranteed accuracy of $\pm 0.5\%$ that provides an accurate output voltage from 0.6V to 3.5V. A 4.5V to 38V input voltage range allows it to support a wide variety of bus voltages. The LTC3875 is available in a low profile 40-lead 6mm \times 6mm (0.5mm pitch) and 40-lead 5mm \times 5mm (0.4mm pitch) QFN packages.

LT, LT, LTC, LTM, Linear Technology, the Linear logo OPTI-LOOP, Burst Mode and PolyPhase are registered trademarks and No R_{SENSE} is a trademark of Linear Technology Corporation. All other trademarks are the property of their respective owners. Protected by U.S. Patents including 5481178, 5705919, 5929620, 6100678, 6144194, 6177787, 6304066, 6580258.

TYPICAL APPLICATION

High Efficiency Dual Phase 1.2V/60A Step-Down Converter

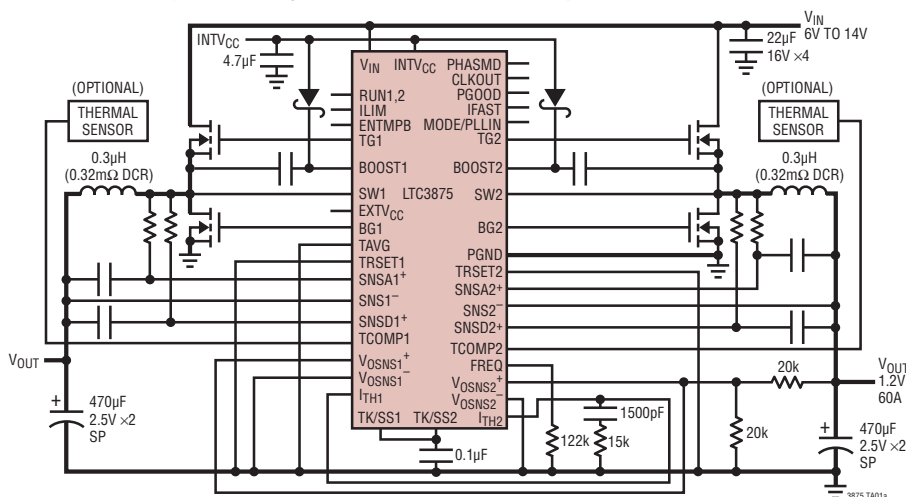

Efficiency and Power Loss vs Load Current

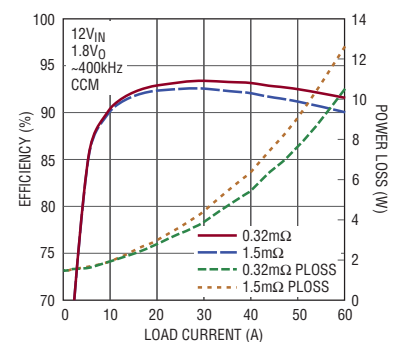

ABSOLUTE MAXIMUM RATINGS

(Note 1)

Input Supply Voltage (V_{IN}) 40V to $-0.3V$
 Topside Driver Voltages
 (BOOST1, BOOST2) 46V to $-0.3V$
 Switch Voltage (SW1, SW2) 40V to $-5V$
 $INTV_{CC}$, RUN(s), PGOOD, $EXTV_{CC}$
 (BOOST-SW1), (BOOST2-SW2) 6V to $-0.3V$
 $SNSA^+(s)$, $SNSD^+(s)$,
 $SNS^-(s)$ Voltages $INTV_{CC}$ to $-0.3V$

MODE/PLLIN, ILIM, FREQ, IFAST, ENTMPB
 $V_{OSNS(s)^+}$, $V_{OSNS(s)^-}$ Voltages $INTV_{CC}$ to $-0.3V$
 I_{TH1} , I_{TH2} , PHASMD, TRSET1, TRSET2,
 TCOMP1, TCOMP2, TAVG Voltages $INTV_{CC}$ to $-0.3V$
 $INTV_{CC}$ Peak Output Current 100mA
 Operating Junction Temperature Range
 (Notes 2, 3) $-40^{\circ}C$ to $125^{\circ}C$
 Storage Temperature Range $-65^{\circ}C$ to $125^{\circ}C$

PIN CONFIGURATION

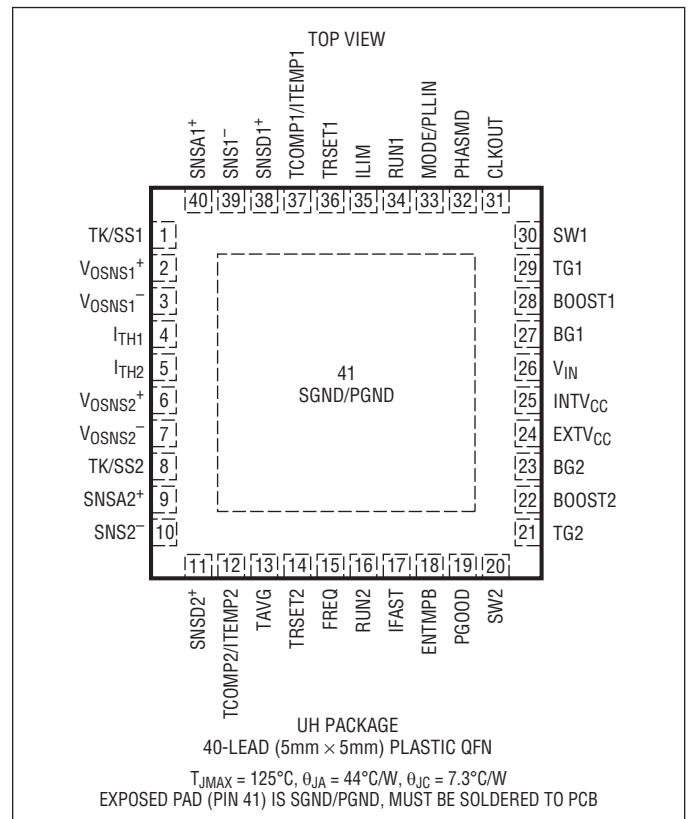
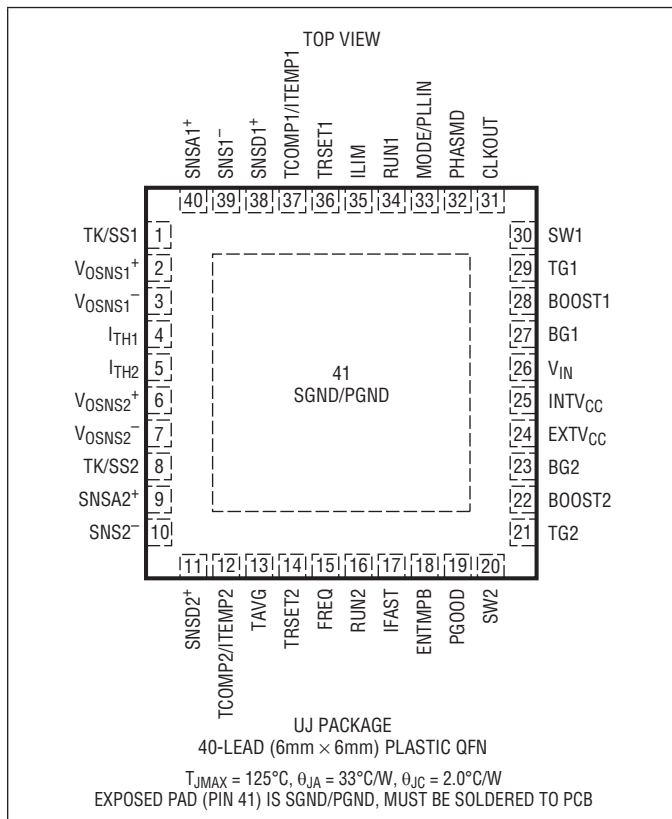

ORDER INFORMATION

LEAD FREE FINISH	TAPE AND REEL	PART MARKING	PACKAGE DESCRIPTION	TEMPERATURE RANGE
LTC3875EUH#PBF	LTC3875EUH#TRPBF	3875	40-Lead (5mm × 5mm) Plastic QFN	–40°C to 125°C
LTC3875IUH#PBF	LTC3875IUH#TRPBF	3875	40-Lead (5mm × 5mm) Plastic QFN	–40°C to 125°C
LTC3875EUJ#PBF	LTC3875EUJ#TRPBF	LTC3875	40-Lead (6mm × 6mm) Plastic QFN	–40°C to 125°C
LTC3875IUJ#PBF	LTC3875IUJ#TRPBF	LTC3875	40-Lead (6mm × 6mm) Plastic QFN	–40°C to 125°C

Consult LTC Marketing for parts specified with wider operating temperature ranges.

For more information on lead free part marking, go to: <http://www.linear.com/leadfree/>

For more information on tape and reel specifications, go to: <http://www.linear.com/tapeandree/>. Some packages are available in 500 unit reels through designated sales channels with #TRMPBF suffix.

ELECTRICAL CHARACTERISTICS

The ● denotes the specifications which apply over the specified operating junction temperature range, otherwise specifications are at $T_A = 25^\circ\text{C}$ (Note 2). $V_{IN} = 15\text{V}$, $V_{RUN1,2} = 5\text{V}$ unless otherwise noted.

SYMBOL	PARAMETER	CONDITIONS	MIN	TYP	MAX	UNITS
Main Control Loops						
V_{IN}	Input Voltage Range		4.5		38	V
V_{OUT}	Output Voltage Range	SNSD ⁺ Pin to V_{OUT} SNSD ⁺ Pin to GND	0.6 0.6		3.5 5	V V
$V_{OSNS1,2}^+$	Regulated V_{OUT} Feedback Voltage Including Diffamp Error	(Note 4); $I_{TH1,2}$ Voltage = 1.2V, –40°C to 85°C (Note 4); $I_{TH1,2}$ Voltage = 1.2V, –40°C to 125°C	● 0.597 0.5965	0.600	0.603 0.6045	V V
$I_{OSNS1,2}^+$	Feedback Current	(Note 4)		–30	–100	nA
$V_{REFLNREG}$	Reference Voltage Line Regulation	$V_{IN} = 4.5\text{V}$ to 38V (Note 4)		0.002	0.005	%/V
$V_{LOADREG}$	Output Voltage Load Regulation	(Note 4) Measured in Servo Loop; ΔI_{TH} Voltage = 1.2V to 0.7V Measured in Servo Loop; ΔI_{TH} Voltage = 1.2V to 1.6V	● ●	0.01 –0.01	0.1 –0.1	% %
$g_{m1,2}$	Transconductance Amplifier g_m	$I_{TH1,2} = 1.2\text{V}$; Sink/Source 5 μA (Note 4)		2.2		mmho
Thermal Functions						
$I_{TCOMP1,2}$	Thermal Sensor Current		29	30	31	μA
T_{SHDN}	Internal Thermal Shutdown	(Note 8)		160		°C
T_{HYS}	Internal TS Hysteresis	(Note 8)		10		°C
Fast Transient Functions						
I_{FAST}	Fast Transient Program Current		● 9	10	11	μA
Current Sensing Functions						
$I_{SENSE(AC)}$	AC Sense Pins Bias Current	Each Channel; $V_{SNSA^+(S)} = 3.3\text{V}$		±0.5	±2	μA
$I_{SENSE(DC)}$	DC Sense Pins Bias Current	Each Channel; $V_{SNSD^+(S)} = 3.3\text{V}$	●	±30	±50	nA
$A_{VT(SNS)}$	Total Sense Gain to Current Comp			5		V/V

ELECTRICAL CHARACTERISTICS

The ● denotes the specifications which apply over the specified operating junction temperature range, otherwise specifications are at $T_A = 25^\circ\text{C}$ (Note 2). $V_{IN} = 15\text{V}$, $V_{RUN1,2} = 5\text{V}$ unless otherwise noted.

SYMBOL	PARAMETER	CONDITIONS	MIN	TYP	MAX	UNITS	
$V_{SENSE(MAX)(DC)}$	Maximum Current Sense Threshold with SNSD ⁺ Pin to V_{OUT}	0°C to 85°C					
		$V_{SNS^-(s)} = 1.2\text{V}$, ILIM = 0V	9	10	11	mV	
		$V_{SNS^-(s)} = 1.2\text{V}$, ILIM = 1/4 INTV _{CC}	14	15	16	mV	
		$V_{SNS^-(s)} = 1.2\text{V}$, ILIM = 1/2 INTV _{CC}	19	20	21	mV	
		$V_{SNS^-(s)} = 1.2\text{V}$, ILIM = 3/4 INTV _{CC}	23.5	25	26.5	mV	
		$V_{SNS^-(s)} = 1.2\text{V}$, ILIM = INTV _{CC}	28.5	30	31.5	mV	
		-40°C to 125°C	●	8.5	10	11.5	mV
		$V_{SNS^-(s)} = 1.2\text{V}$, ILIM = 0V	●	13.5	15	16.5	mV
		$V_{SNS^-(s)} = 1.2\text{V}$, ILIM = 1/4 INTV _{CC}	●	17.5	20	22.5	mV
		$V_{SNS^-(s)} = 1.2\text{V}$, ILIM = 1/2 INTV _{CC}	●	22	25	28	mV
$V_{SNS^-(s)} = 1.2\text{V}$, ILIM = 3/4 INTV _{CC}	●	26.5	30	33.5	mV		
$V_{SENSE(MAX)(NODE)}$	Maximum Current Sense Threshold with SNSD ⁺ Pin to GND	$V_{SNS^-(s)} = 1.2\text{V}$, ILIM = 0V	●	45	50	55	mV
		$V_{SNS^-(s)} = 1.2\text{V}$, ILIM = 1/4 INTV _{CC}	●	70	75	80	mV
		$V_{SNS^-(s)} = 1.2\text{V}$, ILIM = 1/2 INTV _{CC}	●	95	100	105	mV
		$V_{SNS^-(s)} = 1.2\text{V}$, ILIM = 3/4 INTV _{CC}	●	117.5	125	132.5	mV
		$V_{SNS^-(s)} = 1.2\text{V}$, ILIM = INTV _{CC}	●	142.5	150	157.5	mV
$I_{MISMATCH}$	Channel-to-Channel Current Mismatch	ILIM = Float, ENTMPB = Float (Thermal Balance Disabled)			5	%	
I_Q	Input DC Supply Current Normal Mode Shutdown	(Note 5)					
		$V_{IN} = 15\text{V}$ (without EXT _{VCC} Enabled) $V_{RUN1,2} = 0\text{V}$		7	10	mA	
UVLO	Undervoltage Lockout	V_{INTVCC} Ramping Down	3.5	3.7	4.0	V	
UVLO Hyst	UVLO Hysteresis			0.5		V	
V_{OVL}	Feedback Overvoltage Lockout	Measured at $V_{OSNS1,2}^+$	●	0.625	0.645	0.665	V
$I_{TK/SS1,2}$	Soft-Start Charge Current	$V_{TK/SS1,2} = 0\text{V}$	●	1.0	1.25	1.5	μA
$V_{RUN1,2}$	RUN Pin On Threshold	V_{RUN1} , V_{RUN2} Rising	●	1.1	1.22	1.35	V
$V_{RUN1,2HYS}$	RUN Pin On Hysteresis			80		mV	

Driver Functions

TG1,2 t_r TG1,2 t_f	TG Transition Time Rise Time Fall Time	(Note 6)				
		$C_{LOAD} = 3300\text{pF}$ $C_{LOAD} = 3300\text{pF}$		25	25	ns ns
BG1,2 t_r BG1,2 t_f	BG Transition Time Rise Time Fall Time	(Note 6)				
		$C_{LOAD} = 3300\text{pF}$ $C_{LOAD} = 3300\text{pF}$		25	25	ns ns
TG/BG t_{1D}	Top Gate Off to Bottom Gate On Delay Synchronous Switch-On Delay Time	$C_{LOAD} = 3300\text{pF}$ Each Driver		30		ns
BG/TG t_{2D}	Bottom Gate Off to Top Gate On Delay Synchronous Switch-On Delay Time	$C_{LOAD} = 3300\text{pF}$ Each Driver		30		ns
$t_{ON(MIN)}$	Minimum On-Time	(Note 7)		90		ns

ELECTRICAL CHARACTERISTICS

The ● denotes the specifications which apply over the specified operating junction temperature range, otherwise specifications are at $T_A = 25^\circ\text{C}$ (Note 2). $V_{IN} = 15\text{V}$, $V_{RUN1,2} = 5\text{V}$ unless otherwise noted.

SYMBOL	PARAMETER	CONDITIONS	MIN	TYP	MAX	UNITS
INTV_{CC} Linear Regulator						
V_{INTVCC}	Internal V_{CC} Voltage	$6\text{V} < V_{IN} < 38\text{V}$	5.3	5.5	5.7	V
$V_{LDO INT}$	INTV _{CC} Load Regulation	$I_{CC} = 0\text{mA}$ to 20mA		0.5	2.0	%
V_{EXTVCC}	EXTV _{CC} Switchover Voltage	EXTV _{CC} Ramping Positive	● 4.5	4.7		V
$V_{LDO EXT}$	EXTV _{CC} Voltage Drop	$I_{CC} = 20\text{mA}$, $V_{EXTVCC} = 5.5\text{V}$		50	100	mV
V_{LDOHYS}	EXTV _{CC} Hysteresis			200		mV
Oscillator and Phase-Locked Loop						
f_{NOM}	Nominal Frequency	$V_{FREQ} = 1.2\text{V}$	450	500	550	kHz
f_{LOW}	Lowest Frequency	$V_{FREQ} = 0\text{V}$	220	250	270	kHz
f_{HIGH}	Highest Frequency	$V_{FREQ} \geq 2.4\text{V}$	650	720	790	kHz
$R_{MODE/PLLIN}$	MODE/PLLIN Input Resistance			250		k Ω
I_{FREQ}	Frequency Setting Current		9.5	10	10.5	μA
CLKOUT	Phase (Relative to Controller 1)	PHASMD = GND PHASMD = FLOAT PHASMD = INTV _{CC}		60 90 120		Deg Deg Deg
CLK High	Clock Output High Voltage	$V_{INTVCC} = 5.5\text{V}$	4.5	5.5		V
CLK Low	Clock Output Low Voltage				0.2	V
V_{PGL}	PGOOD Voltage Low	$I_{PGOOD} = 2\text{mA}$		0.1	0.3	V
I_{PGOOD}	PGOOD Leakage Current	$V_{PGOOD} = 5.5\text{V}$			± 2	μA
V_{PG}	PGOOD Trip Level, Either Controller	V_{OSNS}^+ with Respect to Set Output Voltage V_{OSNS}^+ Ramping Negative V_{OSNS}^+ Ramping Positive		-7.5 7.5		% %
On-Chip Driver						
TG R _{UP}	TG Pull-Up $R_{DS(ON)}$	TG High		2.6		Ω
TG R _{DOWN}	TG Pull-Down $R_{DS(ON)}$	TG Low		1.5		Ω
BG R _{UP}	BG Pull-Up $R_{DS(ON)}$	BG High		2.4		Ω
BG R _{DOWN}	BG Pull-Down $R_{DS(ON)}$	BG Low		1.1		Ω

Note 1: Stresses beyond those listed under Absolute Maximum Ratings may cause permanent damage to the device. Exposure to any Absolute Maximum Rating condition for extended periods may affect device reliability and lifetime.

Note 2: The LTC3875 is tested under pulsed load conditions such that $T_J \approx T_A$. The LTC3875E is guaranteed to meet specifications from 0°C to 85°C junction temperature. Specifications over the -40°C to 125°C operating junction temperature range are assured by design, characterization and correlation with statistical process controls. The LTC3875I is guaranteed over the full -40° to 125° operating junction temperature range. Note that the maximum ambient temperature consistent with these specifications is determined by specific operating conditions in conjunction with board layout, the rated package thermal impedance and other environmental factors.

Note 3: T_J is calculated from the ambient temperature, T_A , and power dissipation, P_D , according to the formula:

$$T_J = T_A + (P_D \cdot \theta_{JA})^\circ\text{C/W}$$

where $\theta_{JA} = 44^\circ\text{C/W}$ for the $5\text{mm} \times 5\text{mm}$ QFN and $\theta_{JA} = 33^\circ\text{C/W}$ for the $6\text{mm} \times 6\text{mm}$ QFN.

Note 4: The LTC3875 is tested in a feedback loop that servos $V_{ITH1,2}$ to a specified voltage and measures the resultant $V_{OSNS1,2}^+$.

Note 5: Dynamic supply current is higher due to the gate charge being delivered at the switching frequency. See Applications Information.

Note 6: Rise and fall times are measured using 10% and 90% levels. Delay times are measured using 50% levels.

Note 7: The minimum on-time condition is specified for an inductor peak-to-peak ripple current $\geq 40\%$ of I_{MAX} (see Minimum On-Time Considerations in the Applications Information section).

Note 8: Guaranteed by design.

TYPICAL PERFORMANCE CHARACTERISTICS

Efficiency vs Output Current and Mode (Figure 16 Application Circuit)

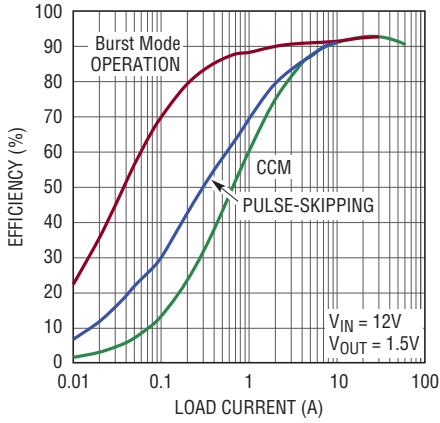

3875 G01

Efficiency vs Output Current and Mode (Figure 16 Application Circuit)

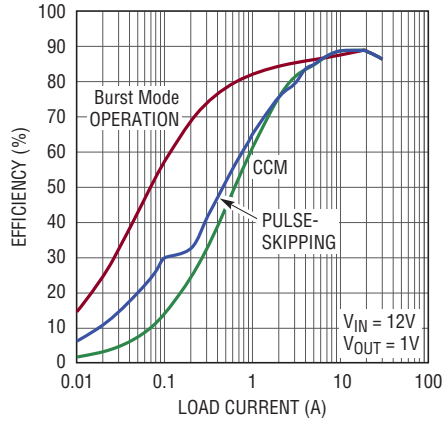

3875 G02

Load Step (Figure 16 Application Circuit) (Burst Mode Operation)

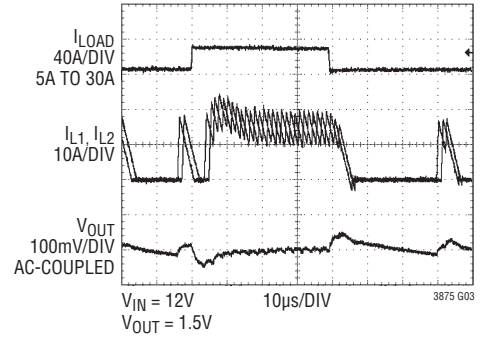

Load Step (Figure 16 Application Circuit) (Forced Continuous Mode)

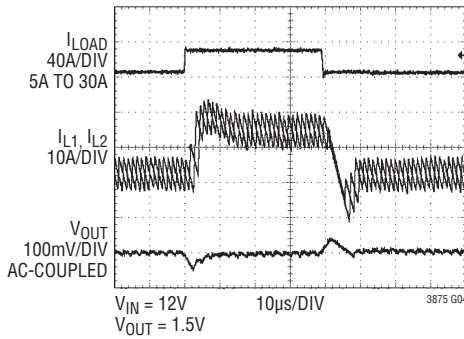

Load Step (Figure 16 Application Circuit) (Pulse-Skipping Mode)

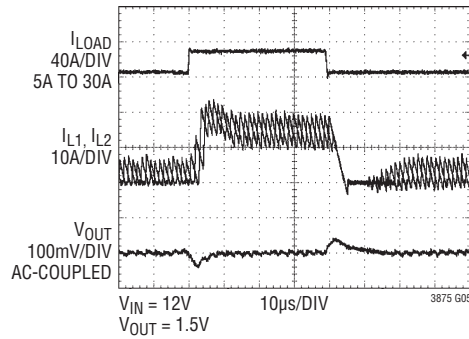

Prebiased Output at 1V

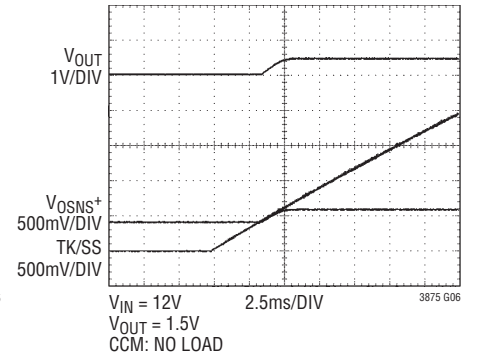

Coincident Tracking

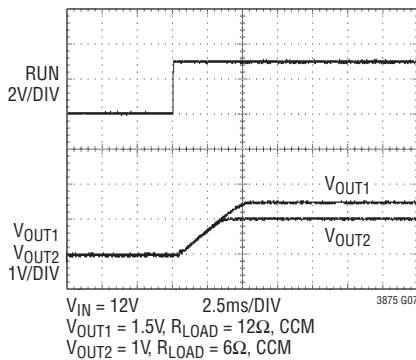

Tracking Up and Down with External Ramp

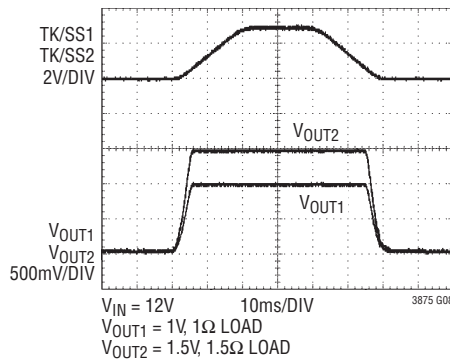

Quiescent Current vs Temperature without EXTVCC

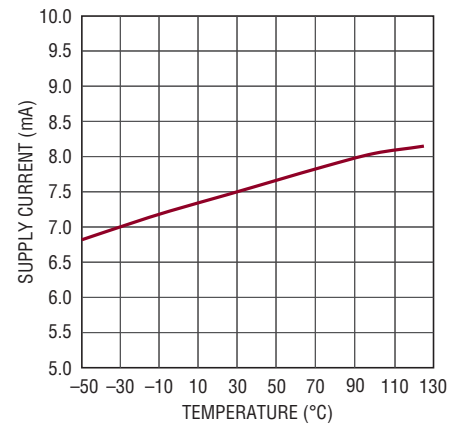

3875 G09

TYPICAL PERFORMANCE CHARACTERISTICS

INTV_{CC} Line Regulation

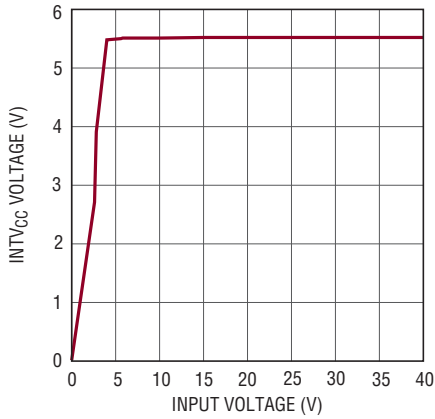

3875 G10

Current Sense Threshold vs I_{TH} Voltage

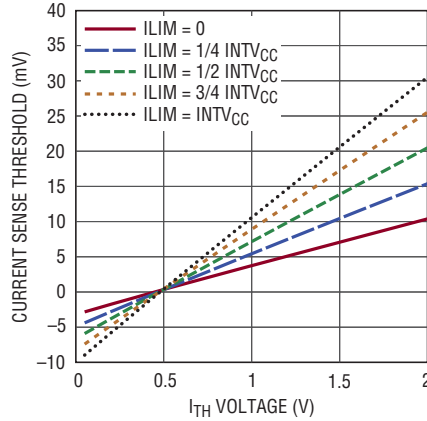

3875 G11

Maximum Current Sense Threshold vs Common Mode Voltage

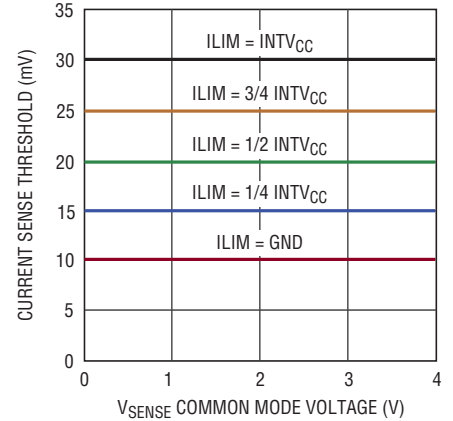

3875 G12

Maximum Current Sense Threshold vs Feedback Voltage (Current Foldback)

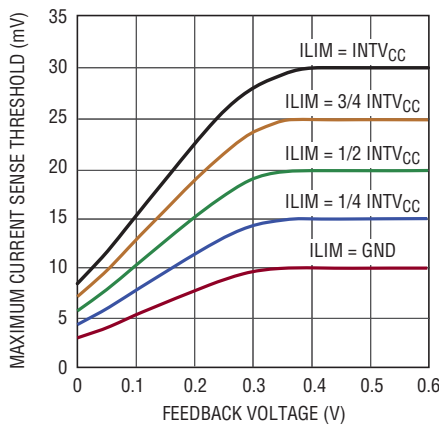

3875 G13

TK/SS Pull-Up Current vs Temperature

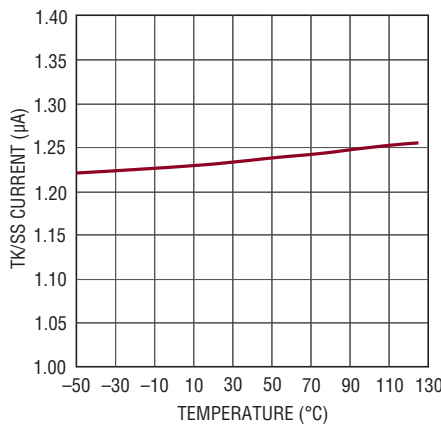

3875 G14

Shutdown (RUN) Threshold vs Temperature

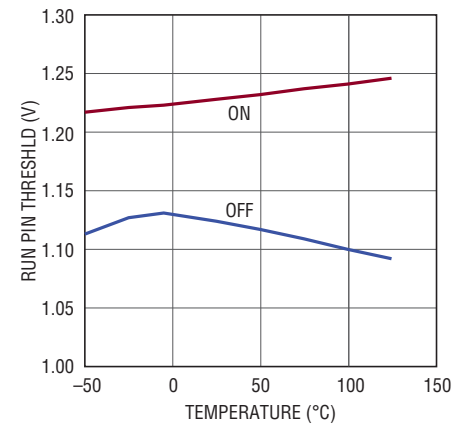

4320 G01

Regulated Feedback Voltage vs Temperature

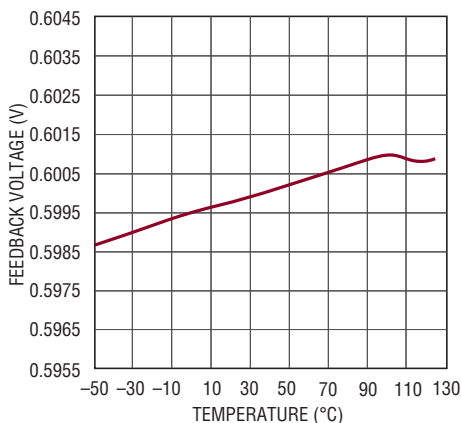

3875 G16

Oscillator Frequency vs Temperature

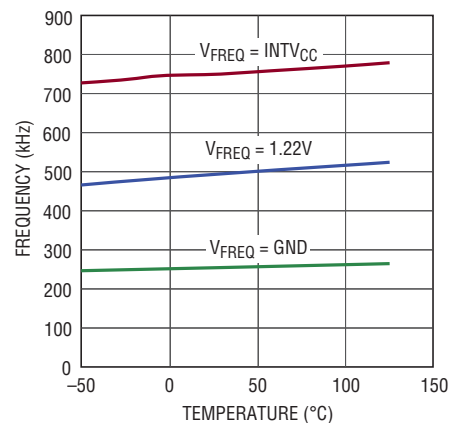

3875 G17

TYPICAL PERFORMANCE CHARACTERISTICS

Undervoltage Lockout Threshold (INTV_{CC}) vs Temperature

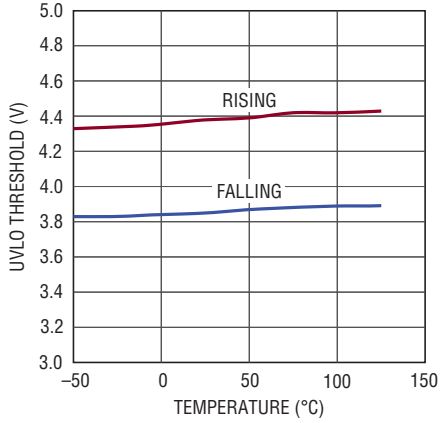

3875 G18

Oscillator Frequency vs Input Voltage

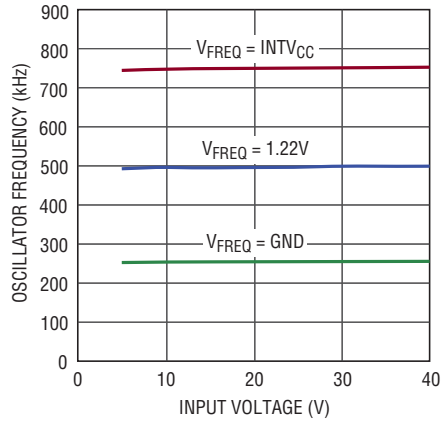

3875 G19

Shutdown Current vs Input Voltage

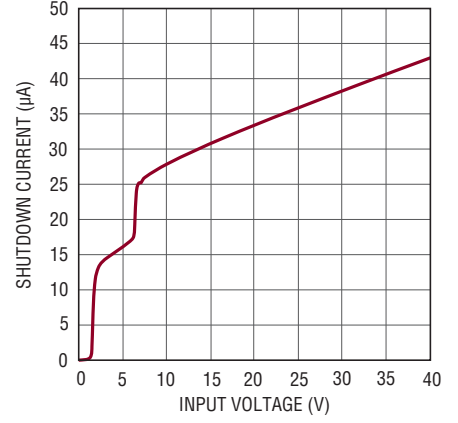

3875 G20

Shutdown Current vs Temperature

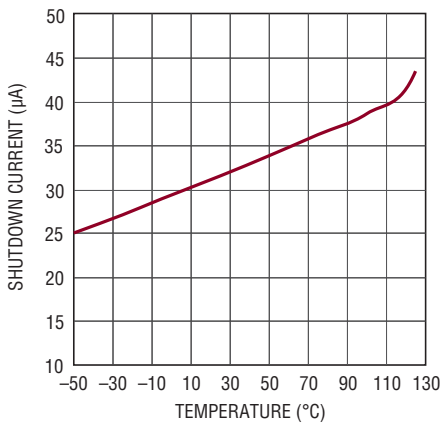

3875 G21

Quiescent Current vs Input Voltage without EXT_V_{CC}

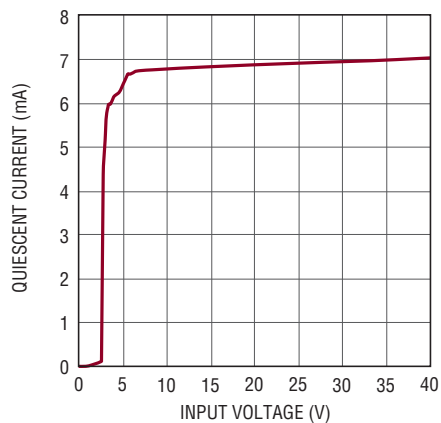

3875 G22

Very Low Output Voltage Ripple

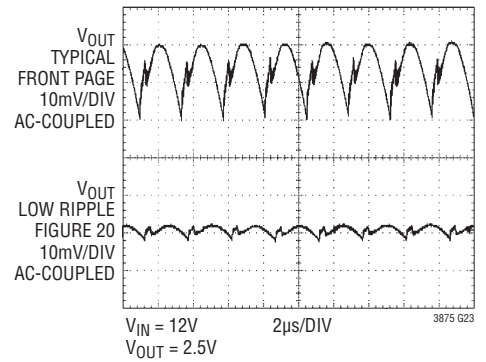

PIN FUNCTIONS

TK/SS1, TK/SS2 (Pin 1, Pin 8): Output Voltage Tracking and Soft-Start Inputs. When one channel is configured to be the master, a capacitor to ground at this pin sets the ramp rate for the master channel's output voltage. When the channel is configured to be the slave, the feedback voltage of the master channel is reproduced by a resistor divider and applied to this pin. Internal soft-start currents of 1.25 μ A charge these pins.

V_{OSNS1}⁺, V_{OSNS2}⁺ (Pin 2, Pin 6): Positive Inputs of Remote Sensing Differential Amplifiers. These pins receive the remotely sensed feedback voltage from external resistive divider across the output. The differential amplifier outputs are connected directly to the error amplifiers' inputs internally inside the IC.

V_{OSNS1}⁻, V_{OSNS2}⁻ (Pin 3, Pin 7): Negative Inputs of Remote Sensing Differential Amplifiers. Connect these pins to the negative terminal of the output capacitors when remote sensing is desired. Connect these pins to local signal ground if remote sensing is not used.

I_{TH1}, I_{TH2} (Pin 4, Pin 5): Current Control Threshold and Error Amplifier Compensation Points. The current comparators' tripping thresholds increase with these control voltages.

TAVG (Pin 13): Average Temperature Summing Point. Connect a resistor to ground to sum all currents together for multi-channels or multi-IC operations when temperature balancing function is enabled. The value of the resistor should be the TRSET resistor value divided by the number of channels in the system. Float this pin if thermal balancing is not used.

FREQ (Pin 15): There is a precision 10 μ A current flowing out of this pin. A resistor to ground sets a voltage which in turn programs the frequency. Alternatively, this pin can be driven with a DC voltage to vary the frequency of the internal oscillator.

IFAST (Pin 17): Programmable Pin for Fast Transient Operation for Channel 2 Only. A resistor to ground programs the threshold of the output load transient excursion. Float this pin to disable this function. See the Applications Information section for more details.

ENTMPB (Pin 18): Enable Pin for Temperature Balancing Function. Ground this pin to enable the temperature balancing function. Float this pin for normal operation.

PGOOD (Pin 19): Power Good Indicator Output. Open-drain logic that is pulled to ground when either channel's output exceeds $\pm 7.5\%$ regulation window, after the internal 20 μ s power bad mask timer expires.

EXTV_{CC} (Pin 24): External Power Input to an Internal Switch Connected to INTV_{CC}. This switch closes and supplies the IC power, bypassing the internal low dropout regulator, whenever EXTV_{CC} is higher than 4.7V. Do not exceed 6V on this pin and make sure that EXTV_{CC} < V_{IN} at all times.

INTV_{CC} (Pin 25): Internal 5.5V Regulator Output. The control circuits are powered from this voltage. Decouple this pin to PGND with a minimum of 4.7 μ F low ESR tantalum or ceramic capacitor.

V_{IN} (Pin 26): Main Input Supply. Decouple this pin to PGND with a capacitor (0.1 μ F to 1 μ F).

BG1, BG2 (Pin 27, Pin 23): Bottom Gate Driver Outputs. These pins drive the gates of the bottom N-channel MOSFETs between INTV_{CC} and PGND.

BOOST1, BOOST2 (Pin 28, Pin 22): Boosted Floating Driver Supplies. The (+) terminal of the booststrap capacitors connect to these pins. These pins swing from a diode voltage drop below INTV_{CC} up to V_{IN} + INTV_{CC}.

TG1, TG2 (Pin 29, Pin 21): Top Gate Driver Outputs. These are the outputs of floating drivers with a voltage swing equal to INTV_{CC} superimposed on the switch node voltage.

SW1, SW2 (Pin 30, Pin 20): Switch Node Connections to Inductors. Voltage swing at these pins is from a Schottky diode (external) voltage drop below ground to V_{IN}.

CLKOUT (Pin 31): Clock Output Pin. Clock output with phase changeable by PHASMD to enable usage of multiple LTC3875s in multiphase systems signal swing is from INTV_{CC} to ground.

PIN FUNCTIONS

PHASMD (Pin 32): Phase Programmable Pin. This pin can be tied to SGND, INTV_{CC} or left floating. It determines the relative phases between the internal controllers as well as the phasing of the CLKOUT signal. See Table 1 in the Operation section for details.

MODE/PLLIN (Pin 33): Forced Continuous Mode, Burst Mode or Pulse-Skipping Mode Selection Pin and External Synchronization Input to Phase Detector Pin. Connect this pin to SGND to force the IC into continuous mode of operation. Connect to INTV_{CC} to enable pulse-skipping mode of operation. Leave the pin floating to enable Burst Mode operation. A clock on the pin will force the IC into continuous mode of operation and synchronize the internal oscillator with the clock on this pin. The PLL compensation network is integrated into the IC.

RUN1, RUN2 (Pin 34, Pin 16): Run Control Inputs. A voltage above 1.22V on either pin turns on the IC. However, forcing both pins below 1.14V causes the IC to shut down. There is a 1.0 μ A pull-up current for both pins. Once the RUN pin rises above 1.22V, an additional 4.5 μ A pull-up current is added to the pin.

ILIM (Pin 35): Current Comparators' Sense Voltage Range Input. A resistor divider sets the maximum current sense threshold to five different levels for the current comparators.

TRSET1, TRSET2 (Pin 36, Pin 14): Input of the Temperature Balancing Circuitries. Connect these pins through resistors to ground to convert the TCOMP pin voltages to currents. These currents are then mirrored to pin TAVG and are added together for all channels. Float this pin if thermal balancing is not used.

TCOMP1/ITEMP1, TCOMP2/ITEMP2 (Pin 37, Pin 12): Input of the Temperature Balancing Circuitries. Connect these pins to external NTC resistors or temperature sensing ICs placed near inductors. These pins are used to sense temperature of each channel and balance the temperature of the whole system accordingly. When thermal balancing function is disabled, these pins can be programmed to compensate the temperature coefficient of the DCR. Connect to an NTC (negative tempco) resistor placed near the output inductor to compensate for its DCR change over temperature. Floating this pin disables the DCR temperature compensation function.

SNSD1⁺, SNSD2⁺ (Pin 38, Pin 11): DC Current Sense Comparator Inputs. The (+) input to the DC current comparator is normally connected to a DC current sensing network. Ground these pins to disable the novel DCR sensing and enable normal DCR sensing with five times current limit.

SNS1⁻, SNS2⁻ (Pin 39, Pin 10): AC and DC Current Sense Comparator Inputs. The (-) inputs to the current comparators are connected to the output.

SNSA1⁺, SNSA2⁺ (Pin 40, Pin 9): AC Current Sense Comparator Inputs. The (+) input to the AC current comparator is normally connected to a DCR sensing network. When combined with the SNSD⁺ pin, the DCR sensing network can be skewed to increase the AC ripple voltage by a factor of 5.

SGND/PGND (Exposed Pad Pin 41): Signal/Power Ground Pin. Connect this pin closely to the sources of the bottom N-channel MOSFETs, the (-) terminal of C_{VCC} and the (-) terminal of C_{IN}. All small-signal components and compensation components should connect to this ground.

BLOCK DIAGRAM (Functional diagram shows one channel only)

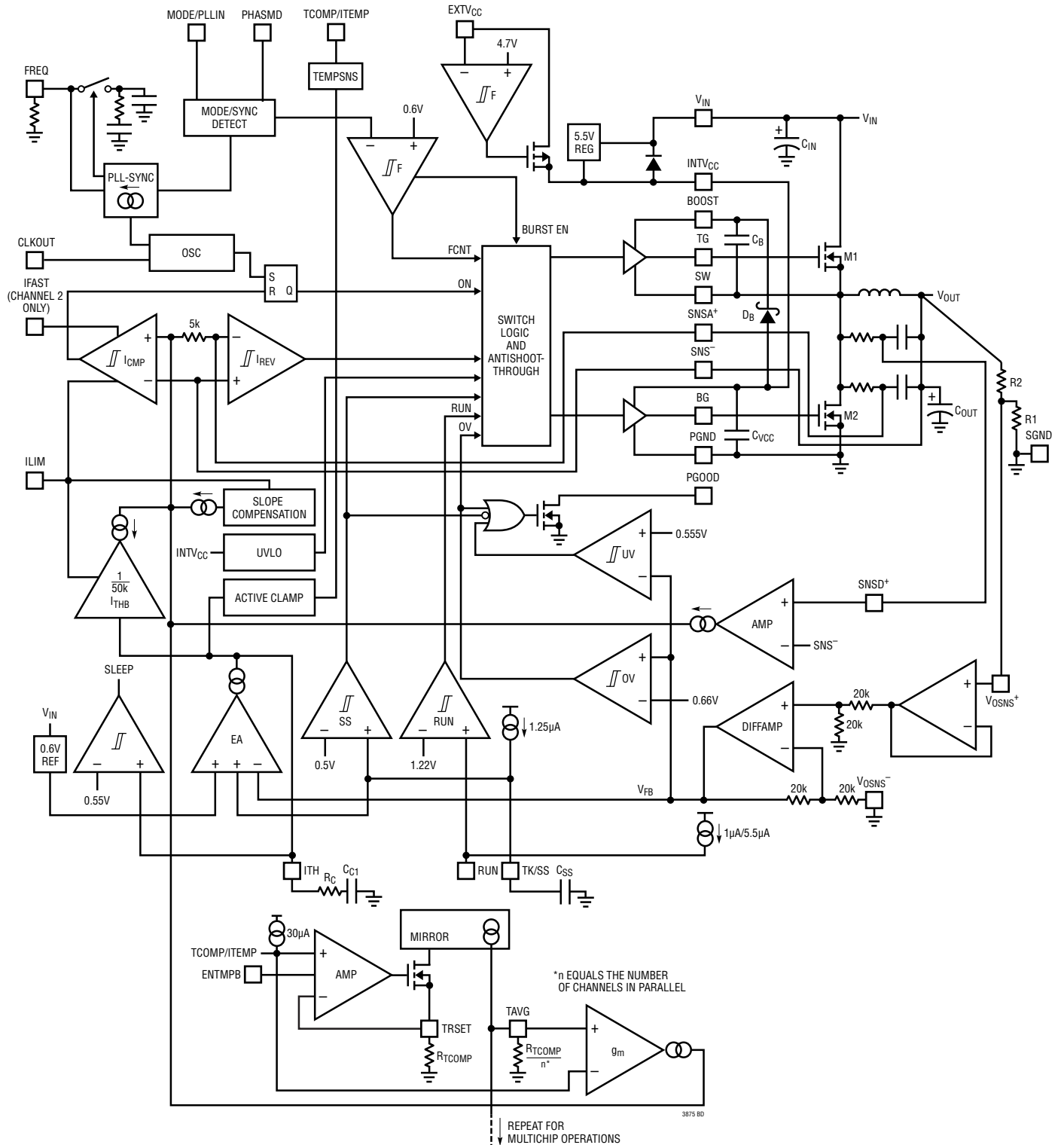

OPERATION

Main Control Loop

The LTC3875 is a constant frequency, current mode step-down controller with two channels operating 180° or 240° out of phase. During normal operation, each top MOSFET is turned on when the clock for that channel sets the R_S latch, and turned off when the main current comparator, I_{CMP} , resets the R_S latch. The peak inductor current at which I_{CMP} resets the R_S latch is controlled by the voltage on the I_{TH} pin, which is the output of each error amplifier EA. The remote sense amplifier (DIFFAMP) converts the sensed differential voltage across the output feedback resistor divider to an internal voltage (V_{FB}) referred to SGND. The V_{FB} signal is then compared to the internal 0.6V reference voltage by the EA. When the load current increases, it causes a slight decrease in V_{FB} relative to the 0.6V reference, which in turn causes the I_{TH} voltage to increase until the average inductor current matches the new load current. After the top MOSFET has turned off, the bottom MOSFET is turned on until either the inductor current starts to reverse, as indicated by the reverse current comparator, I_{REV} , or the beginning of the next cycle.

INTV_{CC}/EXTV_{CC} Power

Power for the top and bottom MOSFET drivers and most other internal circuitry is derived from the INTV_{CC} pin. When the EXTV_{CC} pin is left open or tied to a voltage less than 4.5V, an internal 5.5V linear regulator supplies INTV_{CC} power from V_{IN} . If EXTV_{CC} is taken above 4.7V, the 5.5V regulator is turned off and an internal switch is turned on connecting EXTV_{CC} to INTV_{CC}. When using EXTV_{CC}, the V_{IN} voltage has to be higher than EXTV_{CC} voltage at all time and has to come before EXTV_{CC} is applied. Otherwise, EXTV_{CC} current will flow back to V_{IN} through the internal switch's body diode and potentially damage the device. Using the EXTV_{CC} pin allows the INTV_{CC} power to be derived from a high efficiency external source.

Each top MOSFET driver is biased from the floating bootstrap capacitor, C_B , which normally recharges during each off cycle through an external diode when the top MOSFET turns off. If the input voltage, V_{IN} , decreases to a voltage close to V_{OUT} , the loop may enter dropout and attempt to turn on the top MOSFET continuously. The dropout detector detects this and forces the top MOSFET off for about one-twelfth of the clock period plus 100ns

every third cycle to allow C_B to recharge. However, it is recommended that a load be present or the IC operates at low frequency during the drop-out transition to ensure that C_B is recharged.

Shutdown and Start-Up (RUN1, RUN2 and TK/SS1, TK/SS2 Pins)

The two channels of the LTC3875 can be independently shut down using the RUN1 and RUN2 pins. Pulling either of these pins below 1.14V shuts down the main control loop for that channel. Pulling both pins low disables both channels and most internal circuits, including the INTV_{CC} regulator. Releasing either RUN pin allows an internal 1 μ A current to pull up the pin and enable the controller. Alternatively, the RUN pins may be externally pulled up or driven directly by logic. Be careful not to exceed the absolute maximum rating of 6V on these pins.

The start-up of each channel's output voltage, V_{OUT} , is controlled by the voltage on its TK/SS pin. When the voltage on the TK/SS pin is less than the 0.6V internal reference, the LTC3875 regulates the V_{FB} voltage to the TK/SS pin voltage instead of the 0.6V reference. This allows the TK/SS pin to be used to program the soft-start period by connecting an external capacitor from the TK/SS pin to SGND. An internal 1.25 μ A pull-up current charges this capacitor, creating a voltage ramp on the TK/SS pin. As the TK/SS voltage rises linearly from 0V to 0.6V (and beyond), the output voltage V_{OUT} rises smoothly from zero to its final value. Alternatively the TK/SS pin can be used to cause the start-up of V_{OUT} to "track" that of another supply. Typically, this requires connecting to the TK/SS pin an external resistor divider from the other supply to ground (see the Applications Information section). When the corresponding RUN pin is pulled low to disable a controller, or when INTV_{CC} drops below its undervoltage lockout threshold of 3.7V, the TK/SS pin is pulled low by an internal MOSFET. When in undervoltage lockout, both controllers are disabled and the external MOSFETs are held off.

Internal Soft-Start

By default, the start-up of the output voltage is normally controlled by an internal soft-start ramp. The internal soft-start ramp represents one of the noninverting inputs

3875fb

OPERATION

to the error amplifier. The V_{FB} signal is regulated to the lower of the error amplifier's three noninverting inputs (the internal soft-start ramp, the TK/SS pin or the internal 600mV reference). As the ramp voltage rises from 0V to 0.6V, over approximately 600 μ s, the output voltage rises smoothly from its pre-biased value to its final set value. Certain applications can require the start-up of the converter into a non-zero load voltage, where residual charge is stored on the output capacitor at the onset of converter switching. In order to prevent the output from discharging under these conditions, the top and bottom MOSFETs are disabled until soft-start is greater than V_{FB} .

Light Load Current Operation (Burst Mode Operation, Pulse-Skipping, or Continuous Conduction)

The LTC3875 can be enabled to enter high efficiency Burst Mode operation, constant frequency pulse-skipping mode, or forced continuous conduction mode. To select forced continuous operation, tie the MODE/PLLIN pin to a DC voltage below 0.6V (e.g., SGND). To select pulse-skipping mode of operation, tie the MODE/PLLIN pin to INTV_{CC}. To select Burst Mode operation, float the MODE/PLLIN pin. When a controller is enabled for Burst Mode operation, the peak current in the inductor is set to approximately one-third of the maximum sense voltage even though the voltage on the I_{TH} pin indicates a lower value. If the average inductor current is higher than the load current, the error amplifier, EA, will decrease the voltage on the I_{TH} pin. When the I_{TH} voltage drops below 0.5V, the internal sleep signal goes high (enabling sleep mode) and both external MOSFETs are turned off.

In sleep mode, the load current is supplied by the output capacitor. As the output voltage decreases, the EA's output begins to rise. When the output voltage drops enough, the sleep signal goes low, and the controller resumes normal operation by turning on the top external MOSFET on the next cycle of the internal oscillator. When a controller is enabled for Burst Mode operation, the inductor current is not allowed to reverse. The reverse current comparator (I_{REV}) turns off the bottom external MOSFET just before the inductor current reaches zero, preventing it from reversing and going negative. Thus, the controller operates in discontinuous operation.

In forced continuous operation, the inductor current is allowed to reverse at light loads or under large transient conditions. The peak inductor current is determined by the voltage on the I_{TH} pin. In this mode, the efficiency at light loads is lower than in Burst Mode operation. However, continuous mode has the advantages of lower output ripple and less interference with audio circuitry.

When the MODE/PLLIN pin is connected to INTV_{CC}, the LTC3875 operates in PWM pulse-skipping mode at light loads. At very light loads, the current comparator, I_{COMP}, may remain tripped for several cycles and force the external top MOSFET to stay off for the same number of cycles (i.e., skipping pulses). The inductor current is not allowed to reverse (discontinuous operation). This mode, like forced continuous operation, exhibits low output ripple as well as low audio noise and reduced RF interference as compared to Burst Mode operation. It provides higher low current efficiency than forced continuous mode, but not nearly as high as Burst Mode operation.

Multichip Operations (PHASMD and CLKOUT Pins)

The PHASMD pin determines the relative phases between the internal channels as well as the CLKOUT signal as shown in Table 1. The phases tabulated are relative to zero phase being defined as the rising edge of the clock of phase 1.

Table 1

PHASMD	GND	FLOAT	INTV _{CC}
Phase 1	0°	0°	0°
Phase 2	180°	180°	240°
CLKOUT	60°	90°	120°

The CLKOUT signal can be used to synchronize additional power stages in a multiphase power supply solution feeding a single, high current output or separate outputs. Input capacitance ESR requirements and efficiency losses are substantially reduced because the peak current drawn from the input capacitor is effectively divided by the number of phases used and power loss is proportional to the RMS current squared. A 2-stage, single output voltage implementation can reduce input path power loss by 75% and radically reduce the required RMS current rating of the input capacitor(s).

OPERATION

Single Output Multiphase Operation

The LTC3875 can be used for single output multiphase converters by making these connections

- Tie all of the I_{TH} pins together;
- Tie all of the V_{OSNS}^+ pins together;
- Tie all of the TK/SS pins together;
- Tie all of the RUN pins together.

Examples of single output multiphase converters are shown in the Typical Applications section.

Sensing the Output Voltage

The LTC3875 includes two low offset, high input impedance, unity gain, high bandwidth differential amplifier for applications that require true remote sensing. Differentially sensing the load greatly improves regulation in high current, low voltage applications, where board interconnection losses can be a significant portion of the total error budget. The LTC3875 differential amplifier's positive terminal V_{OSNS}^+ senses the divided output through a resistor divider and its negative terminal V_{OSNS}^- senses the remote ground of the load. The differential amplifier output is connected to the negative terminal of the internal error amplifier inside the controller. Therefore, its differential output signal (V_{FB}) is not accessible from outside the IC. In a typical application where differential sensing is desired, connect the V_{OSNS}^+ pin to the center tap of the feedback divider across the output load, and the V_{OSNS}^- pin to the load ground. When differential sensing is not used, the V_{OSNS}^- pin can be connected to local ground. See Figure 1.

The LTC3875 differential amplifier has a typical output slew rate of $2V/\mu s$. The amplifier is configured for unity gain, meaning that the difference between V_{OSNS}^+ and V_{OSNS}^- is

translated to its output, relative to SGND. Care should be taken to route the V_{OSNS}^+ and V_{OSNS}^- PCB traces parallel to each other all the way to the remote sensing points on the board. In addition, avoid routing these sensitive traces near any high speed switching nodes in the circuit. Ideally, the V_{OSNS}^+ and V_{OSNS}^- traces should be shielded by a low impedance ground plane to maintain signal integrity.

Current Sensing with Very Low Inductor DCR

For low output voltage, high current applications, it's common to use low winding resistance (DCR) inductors to minimize the winding conduction loss and maximize the supply efficiency. Inductor DCR current sensing is also used to eliminate the current sensing resistor and its conduction loss. Unfortunately, with a very low inductor DCR value, $1m\Omega$ or less, the AC current sensing signal ripple can be less than $10mV_{P-P}$. This makes the current loop sensitive to PCB switching noise and causes switching jitter.

The LTC3875 employs a unique and proprietary current sensing architecture to enhance its signal-to-noise ratio in these situations. This enables it to operate with a small sense signal of a very low value inductor DCR, $1m\Omega$ or less. The result is improved power efficiency, and reduced jitter due to switching noise which could corrupt the signal. The LTC3875 can sense a DCR value as low as $0.2m\Omega$ with careful PCB layout. The LTC3875 uses two positive sense pins, SNSD⁺ and SNSA⁺ to acquire signals. It processes them internally to provide the response as with a DCR sense signal that has a 14dB (5 \times) signal-to-noise ratio improvement without affecting output voltage feedback loop. In the meantime, the current limit threshold is still a function of the inductor peak current times its DCR value and its accuracy is also improved five times and can be accurately set from 10mV to 30mV in a 5mV steps with the ILIM pin

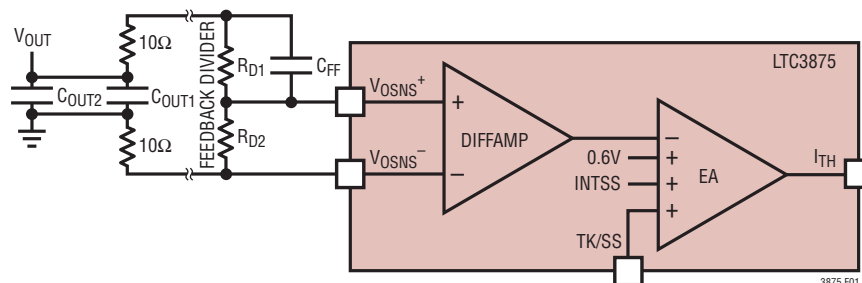

Figure 1. Differential Amplifier Connection

3875fb

OPERATION

(see Figure 4b for inductor DCR sensing connections). The filter time constant, $R1 \cdot C1$, of the SNSD⁺ should match the L/DCR of the output inductor, while the filter at SNSA⁺ should have a bandwidth of five times larger than that of SNSD⁺, i.e., $R2 \cdot C2$ equals one-fifth of $R1 \cdot C1$.

Thermal Balancing For Multiphase Operation

When LTC3875 is used as a single output multiphase converter, the temperature of the whole system can be balanced by enabling the thermal balancing function. This prevents hot spots due to imperfection of current matching and component mismatch. Therefore, it improves the overall reliability of the power supply system.

Refer to Figure 2 for the following discussion of thermal balancing for the LTC3875.

The thermal balancing can be enabled by setting the ENTMPB pin to ground. Each channel has a TCOMP/ITEMP pin which sources a 30 μ A precision current. By connecting a linearized NTC network or a temperature sensing IC placed near the hot spot of the converter from this pin to SGND, the temperature of each channel can be sensed. The sensed voltage from each channel is converted to a current, which is programmable with resistor, R_{TCOMP} , at the TRSET pin. The current from each channel is then summed together at the TAVG pin. The resistor value at the TAVG is R_{TCOMP}/n , where n is the number of phases. The voltage at TAVG is then a representation of the average temperature of the whole system. By comparing the phase temperature and average temperature, an internal transconductance amplifier then adjusts the phase current accordingly to match the phase temperature to the average temperature of the system.

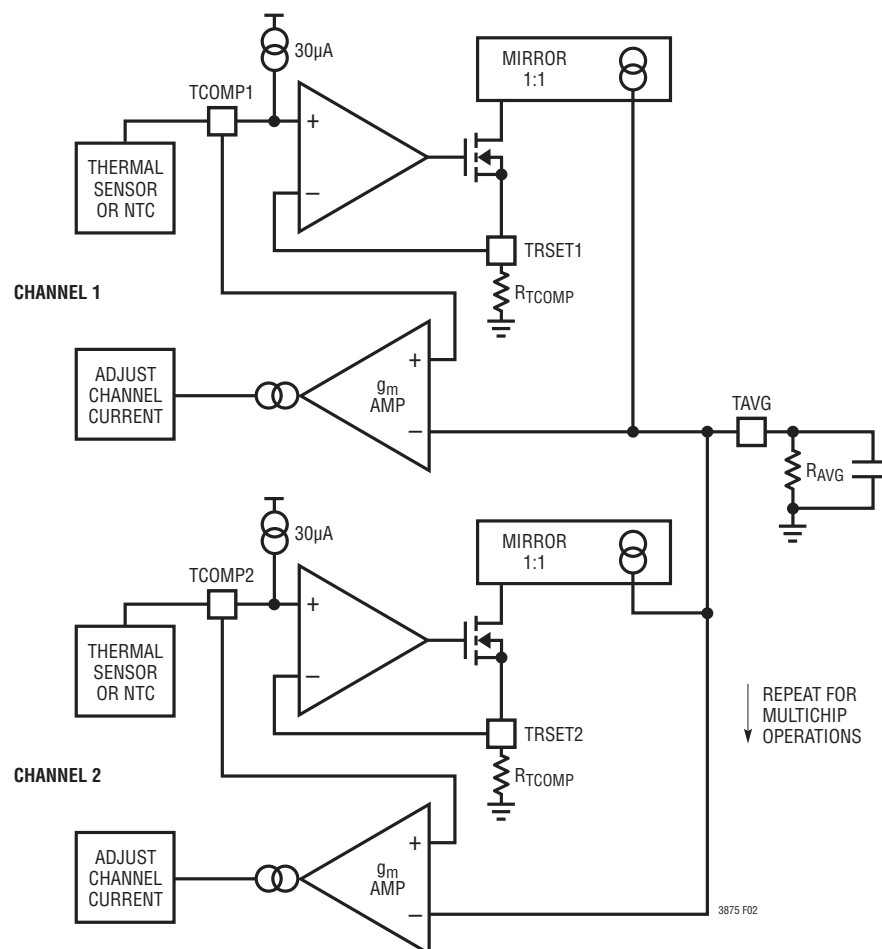

Figure 2. Thermal Balancing Technique for Multichip Operations

OPERATION

Inductor DCR Sensing Temperature Compensation

Inductor DCR current sensing provides a lossless method of sensing the instantaneous current. Therefore, it can provide higher efficiency for applications of high output currents. However the DCR of a copper inductor typically has a positive temperature coefficient. As the temperature of the inductor rises, its DCR value increases. The current limit of the controller is therefore reduced.

LTC3875 offers a method to counter this inaccuracy by allowing the user to place an NTC temperature sensing resistor near the inductor. The ENTMPB pin has to be floating to enable the inductor DCR sensing temperature compensation function. The TCOMP/ITEMP pin, when left floating, is at a voltage around 5.5V and DCR temperature compensation is also disabled. A constant 30μA precision current flows out the TCOMP/ITEMP pin. By connecting a linearized NTC resistor network from the TCOMP/ITEMP pin to SGND, the maximum current sense threshold can be varied over temperature according the following equation:

$$V_{\text{SENSEMAX(ADJ)}} = V_{\text{SENSE(MAX)}} \cdot \frac{2.2 - V_{\text{ITEMP}}}{1.5}$$

where:

$V_{\text{SENSEMAX(ADJ)}}$ is the maximum adjusted current sense threshold.

$V_{\text{SENSE(MAX)}}$ is the maximum current sense threshold specified in the electrical characteristics table. It is typically 10mV, 15mV, 20mV, 25mV or 30mV depending on the setting ILIM pins. V_{ITEMP} is the voltage of the TCOMP/ITEMP pin.

The valid voltage range for DCR temperature compensation on the TCOMP/ITEMP pin is between 0.7V to SGND with 0.7V or above being no DCR temperature correction.

An NTC resistor has a negative temperature coefficient, meaning that its value decreases as temperature rises. The V_{ITEMP} voltage, therefore, decreases as temperature increases and in turn $V_{\text{SENSEMAX(ADJ)}}$ will increase to compensate the DCR temperature coefficient. The NTC resistor, however, is nonlinear, but the user can linearize its value by building a resistor network with regular

resistors. Consult the NTC manufacturer's data sheets for detailed information.

Another use for the TCOMP/ITEMP pins, in addition to NTC compensated DCR sensing, is adjusting $V_{\text{SENSE(MAX)}}$ to values between the nominal values of 10mV, 15mV, 20mV, 25mV and 30mV for a more precise current limit setting. This is done by applying a voltage less than 0.7V to the TCOMP/ITEMP pin. $V_{\text{SENSE(MAX)}}$ will be varied per the above equation. The current limit can be adjusted using this method either with a sense resistor or DCR sensing. The ENTMPB pin also needs to be floating to use this function.

For more information see the NTC Compensated DCR Sensing paragraph in the Applications Information section.

Frequency Selection and Phase-Locked Loop (FREQ and MODE/PLLIN Pins)

The selection of switching frequency is a trade-off between efficiency and component size. Low frequency operation increases efficiency by reducing MOSFET switching losses, but requires larger inductance and/or capacitance to maintain low output ripple voltage. The switching frequency of the LTC3875's controllers can be selected using the FREQ pin. If the MODE/PLLIN pin is not being driven by an external clock source, the FREQ pin can be used to program the controller's operating frequency from 250kHz to 720kHz. There is a precision 10μA current flowing out of the FREQ pin, so the user can program the controller's switching frequency with a single resistor to SGND. A curve is provided later in the application section showing the relationship between the voltage on the FREQ pin and switching frequency. A phase-locked loop (PLL) is integrated on the LTC3875 to synchronize the internal oscillator to an external clock source that is connected to the MODE/PLLIN pin. The controller is operating in forced continuous mode when it is synchronized. The PLL loop filter network is also integrated inside the LTC3875. The phase-locked loop is capable of locking any frequency within the range of 250kHz to 720kHz. The frequency setting resistor should always be present to set the controller's initial switching frequency before locking to the external clock to minimize the transient.

OPERATION

Power Good (PGOOD Pin)

When both V_{OSNS}^+ pins' voltages are not within $\pm 7.5\%$ of the 0.6V reference voltage, the PGOOD pin is pulled low. The PGOOD pin is also pulled low when the RUN pins are below 1.14V or when the LTC3875 is in the soft-start, UVLO or tracking phase. The PGOOD pin will flag power good immediately when both the V_{OSNS}^+ pins are within the $\pm 7.5\%$ of the reference window. However, there is an internal 20 μ s power bad mask when V_{OSNS}^+ voltages go out of the $\pm 7.5\%$ window. The PGOOD pin is allowed to be pulled up by an external resistor to sources of up to 6V.

Output Overvoltage Protection

An overvoltage comparator, OV, guards against transient overshoots ($> 7.5\%$) as well as other more serious conditions that may overvoltage the output. In such cases, the top MOSFET is turned off and the bottom MOSFET is turned on until the overvoltage condition is cleared.

Fast Transient Operation

The LTC3875 also has a transient improvement function implemented on **channel 2**. In normal operation, IFAST pin is floated. This will disable the transient improvement circuit. To enable the transient improvement function, connect a resistor from IFAST pin to ground. The voltage difference between 0.7V and IFAST pin voltage programs the window of sensitivity of when a transient condition is detected. During the load step-up, a comparator monitoring the ripple voltage will compare with the scaled version of the programmed window voltage and trip. This indicates that a load step is detected. The LTC3875 will immediately turn on the top gate and also double the switching frequency for about 20 cycles.

The plots in Figure 3 show the improvement with and without the transient improvement circuit for a typical 12V (V_{IN}) to 1.5V (V_{OUT}) high current application. The circuit with fast transient shows a near 30% improvement for the worst case transient steps. For this application, IFAST pin voltage is programmed to be around 0.62V and the circuit is not very sensitive to this programmed voltage. During the double frequency operation, care has to be taken not to violate the minimum on-time requirement of the LTC3875. The fast transient mode is only enabled in forced continuous mode for channel 2 and is disabled automatically during start-up, or when output is out of regulation window.

In order to properly take advantage of the fast transient circuit, the following equation needs to be satisfied:

$$\frac{V_{SENSE(MAX)}}{30mV} \cdot \left[\frac{0.7 - V_{IFAST}}{25k} + \frac{0.9375}{f_{OSC}} \left(1 - \frac{V_{OUT}}{V_{IN}} \right) \right]$$

$$\bullet 5k \geq 5 \cdot \Delta I_L \cdot DCR$$

where,

$V_{SENSE(MAX)}$ is the maximum sense threshold voltage

V_{IFAST} is the programmed voltage on the IFAST pin

f_{OSC} is the programmed switching frequency

V_{OUT} is the converter's output voltage

V_{IN} is the converter's input voltage

ΔI_L is the inductor ripple current

DCR is the winding resistance of the inductor

As a rule of thumb, the value of the left side of the equation should be 20% larger than the value of the right side of the equation.

OPERATION

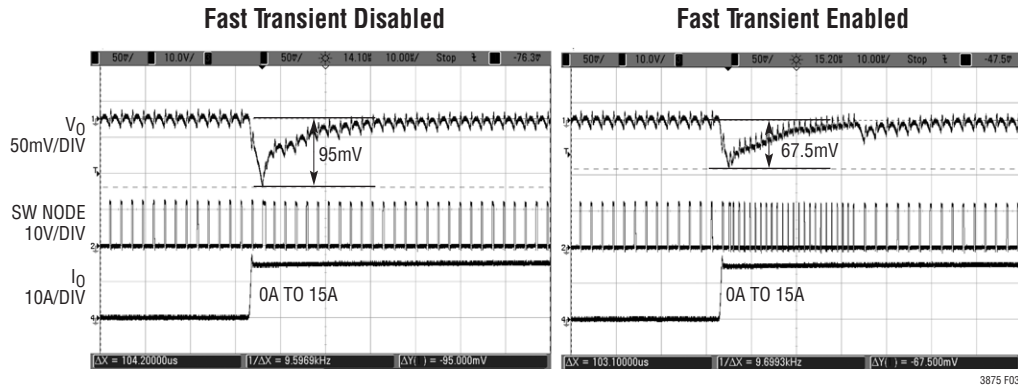

Figure 3. Worst-Case Transient Comparison Between Normal Mode Operation and Fast Transient Mode of Operation for 12V/1.5V Application with 15A Load Step

APPLICATIONS INFORMATION

The Typical Application on the first page of this data sheet is a basic LTC3875 application circuit configured as a dual phase single output power supply. The LTC3875 has an optional thermal balancing function that balances the thermal stress between phases, thus increasing the reliability of the whole system. In addition, the LTC3875 is designed and optimized for use with a very low value DCR inductor by utilizing a novel approach to reduce the noise sensitivity of the sensing signal by a factor of 14dB. DCR sensing is becoming popular because it saves expensive current sensing resistors and is more power efficient, especially in high current applications. However, as the DCR value drops below $1\text{m}\Omega$, the signal-to-noise ratio is low and current sensing is difficult. The LTC3875 uses an LTC proprietary technique to solve this issue with minimum additional external components. In general, external component selection is driven by the load requirement, and begins with the DCR and inductor value. Next, power MOSFETs are selected. Finally, input and output capacitors are selected.

Current Limit Programming

The ILIM pin is a 5-level logic input which sets the maximum current limit of the controller. The input impedance of the ILIM pin is $250\text{k}\Omega$. When ILIM is grounded, floated, or tied to INTV_{CC} , the typical value for the maximum current sense threshold will be 10mV, 20mV, or 30mV, respectively. Setting ILIM to one-fourth INTV_{CC} and three-fourths INTV_{CC}

provides maximum current sense thresholds of 15mV or 25mV. The user should select the proper ILIM level based on the inductor DCR value and targeted current limit level.

SNSD⁺, SNSA⁺ and SNS⁻ Pins

The SNSA⁺ and SNS⁻ pins are the direct inputs to the current comparators, while the SNSD⁺ pin is the input of an internal DC amplifier. The operating input voltage range of 0V to 3.5V is for SNSA⁺, SNSD⁺ and SNS⁻ in a typical application. All the positive sense pins that are connected to the current comparator or the DC amplifier are high impedance with input bias currents of less than $1\mu\text{A}$, but there is a resistance of about 300k from the SNS⁻ pin to ground. The SNS⁻ pin should be connected directly to V_{OUT} . The SNSD⁺ pin connects to the filter that has a $R1 \cdot C1$ time constant equals L/DCR of the inductor. The SNSA⁺ pin is connected to the second filter, $R2 \cdot C2$, with the time constant equals $(R1 \cdot C1)/5$. Care must be taken not to float these pins. Filter components, especially capacitors, must be placed close to the LTC3875, and the sense lines should run close together to a Kelvin connection underneath the current sense element (Figure 4a). Because the LTC3875 is designed to be used with a very low DCR value to sense inductor current, without proper care, the parasitic resistance, capacitance and inductance will degrade the current sense signal integrity, making the programmed current limit unpredictable. As shown in Figure 4b, resistors R1 and R2 are placed close to the

APPLICATIONS INFORMATION

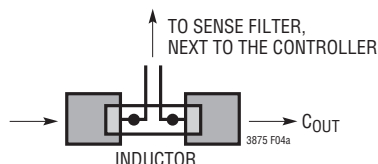

Figure 4a. Sense Lines Placement with Inductor DCR

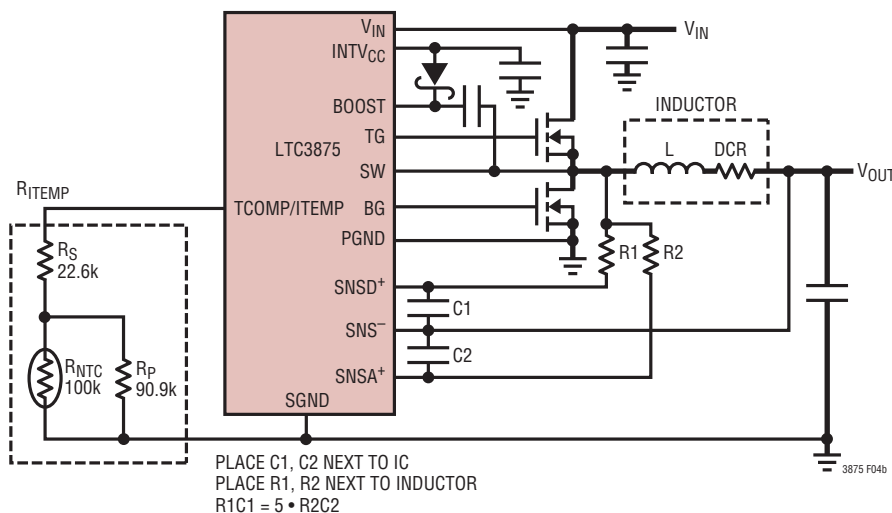

Figure 4b. Inductor DCR Current Sensing

output inductor and capacitors C1 and C2 are close to the IC pins to prevent noise coupling to the sense signal.

For applications where the inductor DCR is large, the LTC3875 could also be used like any typical current mode controller with conventional DCR sensing by disabling the SNSD+ pin, shorting it to ground. An R_{SENSE} resistor or a DCR sensing RC filter can be used to sense the output inductor signal and connects to the SNSA+ pin. If the RC filter is used, its time constant, R • C, equals L/DCR of the output inductor. In these applications, the current limit, V_{SENSE(MAX)}, will be five times the value of V_{SENSE(MAX)} with DC loop enabled, and the operating voltage range of SNSA+ and SNS- is from 0V to 5V. An output voltage of 5V can be generated.

Low Inductor DCR Sensing and Current Limit Estimation

The LTC3875 is specifically designed for high load current applications requiring the highest possible efficiency; it is capable of sensing the signal of an inductor DCR in the sub milliohm range (Figure 4b). The DCR is the inductor DC

winding resistance, which is often less than 1mΩ for high current inductors. In high current and low output voltage applications, conduction loss of a high DCR inductor or a sense resistor will cause a significant reduction in power efficiency. For a specific output requirement and inductor, choose the current limit sensing level that provides proper margin for maximum load current, and uses the relationship of the sense pin filters to output inductor characteristics as depicted below.

$$DCR = \frac{V_{SENSE(MAX)}}{I_{MAX} + \frac{\Delta I_L}{2}}$$

$$L/DCR = R1 \cdot C1 = 5 \cdot R2 \cdot C2$$

where:

V_{SENSE(MAX)} is the maximum sense voltage for a given ILIM threshold.

I_{MAX} is the maximum load current.

ΔI_L is the inductor ripple current.

L/DCR is the output inductor characteristics.

3875fb

APPLICATIONS INFORMATION

$R1 \cdot C1$ is the filter time constant of the SNSD⁺ pin.

$R2 \cdot C2$ is the filter time constant of the SNSA⁺ pin.

For example, for a $12V_{IN}$, 1.2V/30A step-down buck converter running at 400kHz frequency, a 0.15μH, 0.4mΩ inductor is chosen. This inductor provides 15A peak-to-peak ripple current, which is 50% of the 30A full load current. At full load, the inductor peak current is $30A + 15A/2 = 37.5A$.

$$IL(PK) \cdot DCR = 37.5A \cdot 0.4m\Omega = 15mV.$$

In this case, choose the 20mV ILIM setting which is the closest but higher than 15mV to provide margin for current limit.

Select the two R/C sensing network:

Filter on SNSD⁺ pin: $R1 \cdot C1 = L/DCR$,

Filter on SNSA⁺ pin: $R2 \cdot C2 = (L/DCR)/5$.

In this case, the ripple sense signal across SNSA⁺ and SNS⁻ pins is $\Delta IL_{p-p} \cdot DCR \cdot 5 = 15A \cdot 0.4m\Omega \cdot 5 = 30mV$. This signal should be more than 15mV for good signal-to-noise ratio. In this case, it is certainly sufficient.

The peak inductor current at current limit is:

$$ILIM(PK) = 20mV/DCR = 20mV/0.4m\Omega = 50A.$$

The average inductor current, which is also the output current, at current limit is:

$$ILIM(AVG) = ILIM(PK) - \Delta IL_{p-p}/2 = 50A - 15A/2 = 42.5A.$$

To ensure that the load current will be delivered over the full operating temperature range, the temperature coefficient of DCR resistance, approximately 0.4%/°C, should be taken into account. The LTC3875 features a DCR temperature compensation circuit that uses an NTC temperature sensing resistor for this purpose. See the Inductor DCR Sensing Temperature Compensation section for details.

Typically, C1 and C2 are selected in the range of 0.047μF to 0.47μF. If C1 and C2 are chosen to be 100nF, and an inductor of 150nH with 0.4mΩ DCR is selected, R1 and R2 will be 4.64k and 931Ω respectively. The bias current at SNSD⁺ and SNSA⁺ is about 30nA and 500nA respectively, and it causes some small error to the sense signal.

There will be some power loss in R1 and R2 that relates to the duty cycle, and will be the most in continuous mode at the maximum input voltage:

$$P_{LOSS}(R) = \frac{(V_{IN(MAX)} - V_{OUT}) \cdot V_{OUT}}{R}$$

Ensure that R1 and R2 have a power rating higher than this value. However, DCR sensing eliminates the conduction loss of a sense resistor; it will provide a better efficiency at heavy loads. To maintain a good signal-to-noise ratio for the current sense signal, using ΔV_{SENSE} of 15mV between SNSA⁺ and SNS⁻ pins or an equivalent 3mV ripple on the current sense signal. The actual ripple voltage across SNSA⁺ and SNS⁻ pins will be determined by the following equation:

$$\Delta V_{SENSE} = \frac{V_{OUT}}{V_{IN}} \cdot \frac{V_{IN} - V_{OUT}}{R2 \cdot C2 \cdot f_{OSC}}$$

Inductor DCR Sensing Temperature Compensation with NTC Thermistor

For DCR sensing applications, the temperature coefficient of the inductor winding resistance should be taken into account when the accuracy of the current limit is critical over a wide range of temperature. The main element used in inductors is copper; that has a positive tempco of approximately 4000ppm/°C. The LTC3875 provides a feature to correct for this variation through the use of the TCOMP/ITEMP pin. There is a 30μA precision current source flowing out of the TCOMP/ITEMP pin. A thermistor with a NTC (negative temperature coefficient) resistance can be used in a network, R_{ITEMP} (Figure 4b) connected to maintain the current limit threshold constant over a wide operating temperature. The TCOMP/ITEMP voltage range that activates the correction is from 0.7V or less. If this pin is floating, its voltage will be at $INTV_{CC}$ potential, about 5.5V. When the TCOMP/ITEMP voltage is higher than 0.7V, the temperature compensation is inactive. Floating the ENTMPB pin enables the temperature compensation function.

The following guidelines will help to choose components for temperature correction. The initial compensation is for 25°C ambient temperature:

APPLICATIONS INFORMATION

1. Set the TCOMP/ITEMP pin resistance to 23.33k at 25°C. With 30µA flowing out of the TCOMP/ITEMP pin, the voltage on the TCOMP/ITEMP pin will be 0.7V at room temperature. Current limit correction will occur for inductor temperatures greater than 25°C.
2. Calculate the TCOMP/ITEMP pin resistance and the maximum inductor temperature which is typically 100°C. Use the following equations:

$$V_{\text{ITEMP100C}} = 0.7 - 1.5 \left(\frac{I_{\text{MAX}} \cdot \text{DCR (Max)} \cdot (100^\circ\text{C} - 25^\circ\text{C}) \cdot 0.4}{V_{\text{SENSE(MAX)}}} \right) = 0.25\text{V}$$

Since $V_{\text{SENSE(MAX)}} = I_{\text{MAX}} \cdot \text{DCR (Max)}$:

$$R_{\text{ITEMP100C}} = \frac{V_{\text{ITEMP100C}}}{30\mu\text{A}} = 8.33\text{k}$$

where:

$R_{\text{ITEMP100C}}$ = TCOMP/ITEMP pin resistance at 100°C.

$V_{\text{ITEMP100C}}$ = TCOMP/ITEMP pin voltage at 100°C.

$V_{\text{SENSE(MAX)}}$ = Maximum current sense threshold at room temperature.

I_{MAX} = Maximum inductor peak current.

DCR (Max) = Maximum DCR value.

Calculate the values for the NTC network's parallel and series resistors, R_P and R_S . A simple method is to graph the following R_S versus R_P equations with R_S on the y-axis and R_P on the x-axis.

$$R_S = R_{\text{ITEMP25C}} - R_{\text{NTC25C}} \parallel R_P$$

$$R_S = R_{\text{ITEMP100C}} - R_{\text{NTC100C}} \parallel R_P$$

Next, find the value of R_P that satisfies both equations which will be the point where the curves intersect. Once R_P is known, solve for R_S .

The resistance of the NTC thermistor can be obtained from the vendor's data sheet either in the form of graphs, tabulated data, or formulas. The approximate value for the NTC thermistor for a given temperature can be calculated

from the following equation:

$$R = R_0 \cdot \exp \left(B \cdot \left(\frac{1}{T + 273} - \frac{1}{T_0 + 273} \right) \right)$$

where:

R = Resistance at temperature T , which is in degrees C.

R_0 = Resistance at temperature T_0 , typically 25°C.

B = B-constant of the thermistor.

Figure 5 shows a typical resistance curve for a 100k thermistor and the TCOMP/ITEMP pin network over temperature.

Starting values for the NTC compensation network are:

- NTC $R_0 = 100\text{k}$
- $R_S = 3.92\text{k}$
- $R_P = 24.3\text{k}$

But, the final values should be calculated using the above equations and checked at 25°C and 100°C. After determining the components for the temperature compensation network, check the results by plotting I_{MAX} versus inductor temperature using the following equations:

$$I_{\text{DC(MAX)}} = \frac{V_{\text{SENSEMAX(ADJ)}} - \frac{\Delta V_{\text{SENSE}}}{2}}{\text{DCR(MAX)} \text{ at } 25^\circ\text{C} \cdot \left(1 + (T_{\text{L(MAX)}} - 25^\circ\text{C}) \cdot \frac{0.4}{100} \right)}$$

where:

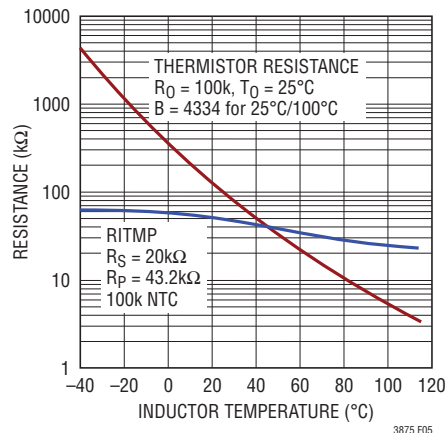

Figure 5. Resistance Versus Temperature for ITEMP Pin Network and the 100k NTC

APPLICATIONS INFORMATION

$$V_{SENSEMAX(ADJ)} = V_{SENSE(MAX)} \cdot \frac{2.2 - V_{ITEMP}}{1.5}$$

$$V_{ITEMP} = 30\mu A \cdot (R_S + R_P || R_{NTC})$$

$I_{DC(MAX)}$ = Maximum average inductor current.

TC is the inductor temperature.

The resulting current limit should be greater than or equal to I_{MAX} for inductor temperatures between 25°C and 100°C.

Typical values for the NTC compensation network are:

- NTC $R_0 = 100k$, B-constant = 3000 to 4000
- $R_S \approx 3.92k$
- $R_P \approx 24.3k$

Generating the I_{MAX} versus inductor temperature curve plot first using the above values as a starting point, and then adjusting the R_S and R_P values as necessary, is another approach. Figure 6 shows a curve of I_{MAX} versus inductor temperature. For PolyPhase® applications, tie the TCOMP/ITEMP pins together and calculate for an TCOMP/ITEMP pin current of $30\mu A \cdot \#phases$.

For the most accurate temperature detection, place the thermistors next to the inductors as shown in Figure 7. Take care to keep the TCOMP/ITEMP pins away from the switch nodes and gate traces.

Slope Compensation and Inductor Peak Current

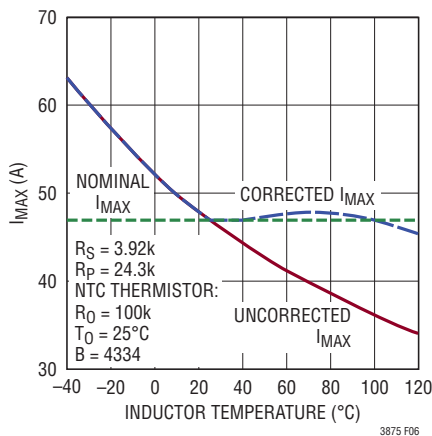
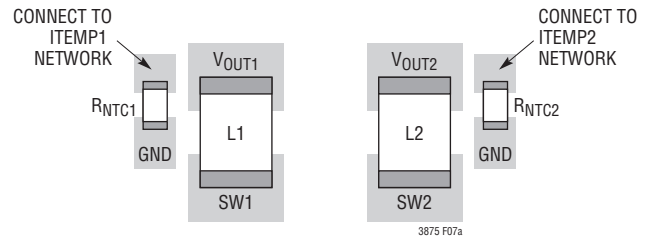
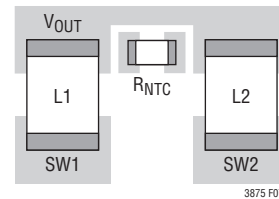

Figure 6. Worst-Case I_{MAX} vs Inductor Temperature Curve with and without NTC Temperature Compensation



(7a) Dual Output Dual Phase DCR Sensing Application



(7b) Single Output Dual Phase DCR Sensing Application

Figure 7. Thermistor Locations. Place Thermistor Next to Inductor(s) for Accurate Sensing of the Inductor Temperature, but Keep the ITEMP Pins away from the Switch Nodes and Gate Traces

Slope compensation provides stability in constant frequency architectures by preventing sub-harmonic oscillations at high duty cycles. It is accomplished internally by adding a compensating ramp to the inductor current signal at duty cycles in excess of 40%. Normally, this results in a reduction of maximum inductor peak current for duty cycles > 40%. However, the LTC3875 uses a scheme that counteracts this compensating ramp, which allows the maximum inductor peak current to remain unaffected throughout all duty cycles.

Inductor Value Calculation

Given the desired input and output voltages, the inductor value and operating frequency, f_{OSC} , directly determine the inductor's peak-to-peak ripple current:

$$I_{RIPPLE} = \frac{V_{OUT}}{V_{IN}} \left(\frac{V_{IN} - V_{OUT}}{f_{OSC} \cdot L} \right)$$

Lower ripple current reduces core losses in the inductor, ESR losses in the output capacitors, and output voltage ripple. Thus, highest efficiency operation is obtained at low frequency with a small ripple current. Achieving this, however, requires a large inductor.

APPLICATIONS INFORMATION

A reasonable starting point is to choose a ripple current that is about 40% of $I_{OUT(MAX)}$. Note that the largest ripple current occurs at the highest input voltage. To guarantee that ripple current does not exceed a specified maximum, the inductor should be chosen according to:

$$L \geq \frac{V_{IN} - V_{OUT}}{f_{OSC} \cdot I_{RIPPLE}} \cdot \frac{V_{OUT}}{V_{IN}}$$

Inductor Core Selection

Once the inductance value is determined, the type of inductor must be selected. Core loss is independent of core size for a fixed inductor value, but it is very dependent on inductance selected. As inductance increases, core losses go down. Unfortunately, increased inductance requires more turns of wire and therefore copper losses will increase. Ferrite designs have very low core loss and are preferred at high switching frequencies, so design goals can concentrate on copper loss and preventing saturation. Ferrite core material saturates “hard,” which means that inductance collapses abruptly when the peak design current is exceeded. This results in an abrupt increase in inductor ripple current and consequent output voltage ripple. Do not allow the core to saturate!

Power MOSFET and Schottky Diode (Optional) Selection

At least two external power MOSFETs need to be selected: One N-channel MOSFET for the top (main) switch and one or more N-channel MOSFET(s) for the bottom (synchronous) switch. The number, type and on-resistance of all MOSFETs selected take into account the voltage step-down ratio as well as the actual position (main or synchronous) in which the MOSFET will be used. A much smaller and much lower input capacitance MOSFET should be used for the top MOSFET in applications that have an output voltage that is less than one-third of the input voltage. In applications where $V_{IN} \gg V_{OUT}$, the top MOSFETs' on-resistance is normally less important for overall efficiency than its input capacitance at operating frequencies above 300kHz. MOSFET manufacturers have designed special purpose devices that provide reasonably low on-resistance with significantly reduced input capacitance for the main switch application in switching regulators.

The peak-to-peak MOSFET gate drive levels are set by the internal regulator voltage, V_{INTVCC} , requiring the use of logic-level threshold MOSFETs in most applications. Pay close attention to the $BVDSS$ specification for the MOSFETs as well; many of the logic-level MOSFETs are limited to 30V or less. Selection criteria for the power MOSFETs include the on-resistance, $R_{DS(ON)}$, input capacitance, input voltage and maximum output current. MOSFET input capacitance is a combination of several components but can be taken from the typical gate charge curve included on most data sheets (Figure 8). The curve is generated by forcing a constant input current into the gate of a common source, current source loaded stage and then plotting the gate voltage versus time. The initial slope is the effect of the gate-to-source and the gate-to-drain capacitance. The flat portion of the curve is the result of the Miller multiplication effect of the drain-to-gate capacitance as the drain drops the voltage across the current source load. The upper sloping line is due to the drain-to-gate accumulation capacitance and the gate-to-source capacitance. The Miller charge (the increase in coulombs on the horizontal axis from a to b while the curve is flat) is specified for a given V_{DS} drain voltage, but can be adjusted for different V_{DS} voltages by multiplying the ratio of the application V_{DS} to the curve specified V_{DS} values. A way to estimate the C_{MILLER} term is to take the change in gate charge from points a and b on a manufacturer's data sheet and divide by the stated V_{DS} voltage specified. C_{MILLER} is the most important selection criteria for determining the transition loss term in the top MOSFET but is not directly specified on MOSFET data sheets. C_{RSS} and C_{OS} are specified sometimes but definitions of these parameters are not included. When the controller is operating in continuous mode the duty cycles for the top and bottom MOSFETs are given by:

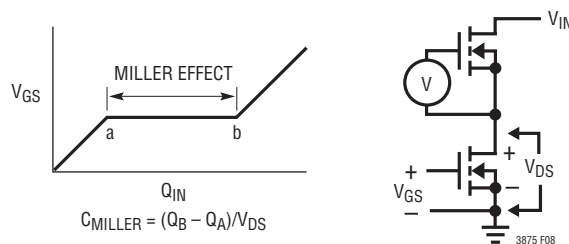

Figure 8. Gate Charge Characteristic

APPLICATIONS INFORMATION

$$\text{Main Switch Duty Cycle} = \frac{V_{\text{OUT}}}{V_{\text{IN}}}$$

$$\text{Synchronous Switch Duty Cycle} = \left(\frac{V_{\text{IN}} - V_{\text{OUT}}}{V_{\text{IN}}} \right)$$

The power dissipation for the main and synchronous MOSFETs at maximum output current are given by:

$$P_{\text{MAIN}} = \frac{V_{\text{OUT}}}{V_{\text{IN}}} (I_{\text{MAX}})^2 (1 + \delta) R_{\text{DS(ON)}} + (V_{\text{IN}})^2 \left(\frac{I_{\text{MAX}}}{2} \right) (R_{\text{DR}}) (C_{\text{MILLER}}) \cdot \left[\frac{1}{V_{\text{INTVCC}} - V_{\text{MILLER}}} + \frac{1}{V_{\text{MILLER}}} \right] \cdot f$$

$$P_{\text{SYNC}} = \frac{V_{\text{IN}} - V_{\text{OUT}}}{V_{\text{IN}}} (I_{\text{MAX}})^2 (1 + \delta) R_{\text{DS(ON)}}$$

where δ is the temperature dependency of $R_{\text{DS(ON)}}$, R_{DR} is the effective top driver resistance (approximately 2Ω at $V_{\text{GS}} = V_{\text{MILLER}}$), V_{IN} is the drain potential and the change in drain potential in the particular application. V_{MILLER} is the data sheet specified typical gate threshold voltage specified in the power MOSFET data sheet at the specified drain current. C_{MILLER} is the calculated capacitance using the gate charge curve from the MOSFET data sheet and the technique described above. Both MOSFETs have I^2R losses while the topside N-channel equation includes an additional term for transition losses, which peak at the highest input voltage. For $V_{\text{IN}} < 20\text{V}$, the high current efficiency generally improves with larger MOSFETs, while for $V_{\text{IN}} > 20\text{V}$, the transition losses rapidly increase to the point that the use of a higher $R_{\text{DS(ON)}}$ device with lower C_{MILLER} actually provides higher efficiency. The synchronous MOSFET losses are greatest at high input voltage when the top switch duty factor is low or during a short-circuit when the synchronous switch is on close to 100% of the period.

The term $(1 + \delta)$ is generally given for a MOSFET in the form of a normalized $R_{\text{DS(ON)}}$ vs temperature curve, but $\delta = 0.005/^\circ\text{C}$ can be used as an approximation for low voltage MOSFETs.

An optional Schottky diode across the synchronous MOSFET conducts during the dead time between the conduction of the two large power MOSFETs. This prevents the body diode of the bottom MOSFET from turning on, storing charge during the dead time and requiring a reverse-recovery period which could cost as much as several percent in efficiency. A 2A to 8A Schottky is generally a good compromise for both regions of operation due to the relatively small average current. Larger diodes result in additional transition loss due to their larger junction capacitance.

Soft-Start and Tracking

The LTC3875 has the ability to either soft-start by itself with a capacitor or track the output of another channel or external supply. When one particular channel is configured to soft-start by itself, a capacitor should be connected to its TK/SS pin. This channel is in the shutdown state if its RUN pin voltage is below 1.14V. Its TK/SS pin is actively pulled to ground in this shutdown state.

Once the RUN pin voltage is above 1.22V, the channel powers up. A soft-start current of $1.25\mu\text{A}$ then starts to charge its soft-start capacitor. Note that soft-start or tracking is achieved not by limiting the maximum output current of the controller but by controlling the output ramp voltage according to the ramp rate on the TK/SS pin. Current fold-back is disabled during this phase to ensure smooth soft-start or tracking. The soft-start or tracking range is defined to be the voltage range from 0V to 0.6V on the TK/SS pin. The total soft-start time can be calculated as:

$$t_{\text{SOFTSTART}} = 0.6 \cdot \frac{C_{\text{SS}}}{1.25\mu\text{A}}$$

Regardless of the mode selected by the MODE/PLLIN pin, the regulator will always start in pulse-skipping mode up to $\text{TK/SS} = 0.5\text{V}$. Between $\text{TK/SS} = 0.5\text{V}$ and 0.56V , it will operate in forced continuous mode and revert to the selected mode once $\text{TK/SS} > 0.56\text{V}$. The output ripple is minimized during the 60mV forced continuous mode window ensuring a clean PGOOD signal.

When the channel is configured to track another supply, the feedback voltage of the other supply is duplicated by

APPLICATIONS INFORMATION

a resistor divider and applied to the TK/SS pin. Therefore, the voltage ramp rate on this pin is determined by the ramp rate of the other supply's voltage. Note that the small soft-start capacitor charging current is always flowing, producing a small offset error. To minimize this error, select the tracking resistive divider value to be small enough to make this error negligible. In order to track down another channel or supply after the soft-start phase expires, the LTC3875 is forced into continuous mode of operation as soon as V_{FB} is below the undervoltage threshold of 0.55V regardless of the setting on the MODE/PLLIN pin. However, the LTC3875 should always be set in forced continuous mode tracking down when there is no load. After TK/SS drops below 0.1V, its channel will operate in discontinuous mode.

The LTC3875 allows the user to program how its output ramps up and down by means of the TK/SS pins. Through these pins, the output can be set up to either coincidentally or ratiometrically track another supply's output, as shown in Figure 9. In the following discussions, V_{OUT1} refers to

the LTC3875's output 1 as a master channel and V_{OUT2} refers to the LTC3875's output 2 as a slave channel. In practice, though, either phase can be used as the master. To implement the coincident tracking in Figure 9a, connect an additional resistive divider to V_{OUT1} and connect its midpoint to the TK/SS pin of the slave channel. The ratio of this divider should be the same as that of the slave channel's feedback divider shown in Figure 10a. In this tracking mode, V_{OUT1} must be set higher than V_{OUT2} . To implement the ratiometric tracking in Figure 10b, the ratio of the V_{OUT2} divider should be exactly the same as the master channel's feedback divider shown in Figure 9b. By selecting different resistors, the LTC3875 can achieve different modes of tracking including the two in Figure 9.

So which mode should be programmed? While either mode in Figure 9 satisfies most practical applications, some trade-offs exist. The ratiometric mode saves a pair of resistors, but the coincident mode offers better output regulation. When the master channel's output experiences dynamic excursion (under load transient, for example),

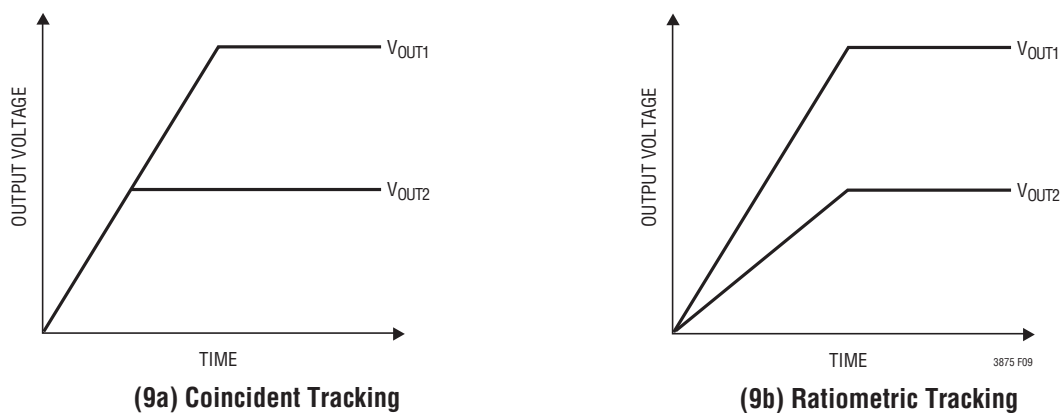

Figure 9. Two Different Modes of Output Voltage Tracking

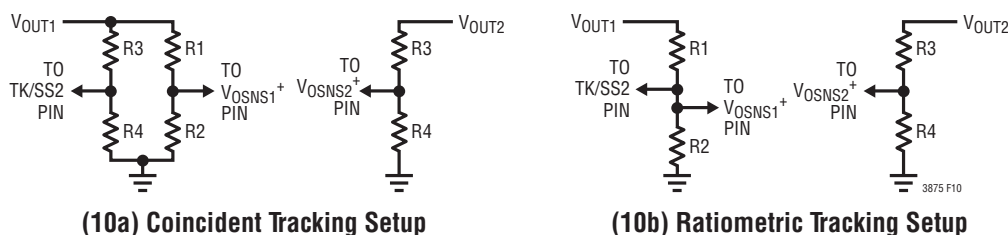

Figure 10. Setup for Coincident and Ratiometric Tracking

APPLICATIONS INFORMATION

the slave channel output will be affected as well. For better output regulation, use the coincident tracking mode instead of ratiometric.

Pre-Biased Output Start-Up

There may be situations that require the power supply to start up with a pre-bias on the output capacitors. In this case, it is desirable to start up without discharging that output pre-bias. The LTC3875 can safely power up into a pre-biased output without discharging it. The LTC3875 accomplishes this by disabling both TG and BG until the TK/SS pin voltage and the internal soft-start voltage are above the V_{OSNS}^+ pin voltage. When V_{OSNS}^+ is higher than TK/SS or the internal soft-start voltage, the error amp output is low. The control loop would like to turn BG on, which would discharge the output. Disabling BG and TG prevents the pre-biased output voltage from being discharged. When TK/SS and the internal soft-start both cross 500mV or V_{OSNS}^+ , whichever is lower, TG and BG are enabled. If the pre-bias is higher than the OV threshold, the bottom gate is turned on immediately to pull the output back into the regulation window.

INTV_{CC} Regulators and EXTV_{CC}

The LTC3875 features a PMOS LDO that supplies power to INTV_{CC} from the V_{IN} supply. INTV_{CC} powers the gate drivers and much of the LTC3875's internal circuitry. The linear regulator regulates the voltage at the INTV_{CC} pin to 5.5V when V_{IN} is greater than 6V. EXTV_{CC} connects to INTV_{CC} through a P-channel MOSFET and can supply the needed power when its voltage is higher than 4.7V. Each of these can supply a peak current of 100mA and must be bypassed to ground with a minimum of a 4.7 μ F ceramic capacitor or a low ESR electrolytic capacitor. No matter what type of bulk capacitor is used, an additional 0.1 μ F ceramic capacitor placed directly adjacent to the INTV_{CC} and PGND pins is highly recommended. Good bypassing is needed to supply the high transient currents required by the MOSFET gate drivers and to prevent interaction between the channels.

High input voltage applications in which large MOSFETs are being driven at high frequencies may cause the maxi-

imum junction temperature rating for the LTC3875 to be exceeded. The INTV_{CC} current, which is dominated by the gate charge current, may be supplied by either the 5.5V linear regulator or EXTV_{CC}. When the voltage on the EXTV_{CC} pin is less than 4.7V, the linear regulator is enabled. Power dissipation for the IC in this case is highest and is equal to $V_{IN} \cdot I_{INTVCC}$. The gate charge current is dependent on operating frequency as discussed in the Efficiency Considerations section. The junction temperature can be estimated by using the equations given in Note 3 of the Electrical Characteristics. For example, the LTC3875 INTV_{CC} current is limited to less than 44mA from a 38V supply in the UJ package and not using the EXTV_{CC} supply:

$$T_J = 70^\circ\text{C} + (44\text{mA})(38\text{V})(33^\circ\text{C}/\text{W}) = 125^\circ\text{C}$$

To prevent the maximum junction temperature from being exceeded, the input supply current must be checked while operating in continuous conduction mode (MODE/PLLIN = SGND) at maximum V_{IN} . When the voltage applied to EXTV_{CC} rises above 4.7V, the INTV_{CC} linear regulator is turned off and the EXTV_{CC} is connected to the INTV_{CC}. The EXTV_{CC} remains on as long as the voltage applied to EXTV_{CC} remains above 4.5V. Using the EXTV_{CC} allows the MOSFET driver and control power to be derived from one of the LTC3875's switching regulator outputs during normal operation and from the INTV_{CC} when the output is out of regulation (e.g., start-up, short-circuit). If more current is required through the EXTV_{CC} than is specified, an external Schottky diode can be added between the EXTV_{CC} and INTV_{CC} pins. Do not apply more than 6V to the EXTV_{CC} pin and make sure that $\text{EXTV}_{CC} < V_{IN}$.

Significant efficiency and thermal gains can be realized by powering INTV_{CC} from the output, since the V_{IN} current resulting from the driver and control currents will be scaled by a factor of (Duty Cycle)/(Switcher Efficiency). Tying the EXTV_{CC} pin to a 5V supply reduces the junction temperature in the previous example from 125°C to:

$$T_J = 70^\circ\text{C} + (44\text{mA})(5\text{V})(33^\circ\text{C}/\text{W}) = 77^\circ\text{C}$$

However, for 3.3V and other low voltage outputs, additional circuitry is required to derive INTV_{CC} power from the output.

APPLICATIONS INFORMATION

The following list summarizes the four possible connections for EXTV_{CC}:

1. EXTV_{CC} left open (or grounded). This will cause INTV_{CC} to be powered from the internal 5.5V regulator resulting in an efficiency penalty at high input voltages.
2. EXTV_{CC} connected directly to V_{OUT}. This is the normal connection for a 5V regulator and provides the highest efficiency.
3. EXTV_{CC} connected to an external supply. If a 5V external supply is available, it may be used to power EXTV_{CC} providing it is compatible with the MOSFET gate drive requirements.
4. EXTV_{CC} connected to an output-derived boost network. For 3.3V and other low voltage regulators, efficiency gains can still be realized by connecting EXTV_{CC} to an output-derived voltage that has been boosted to greater than 4.7V.

For applications where the main input power is below 5V, tie the V_{IN} and INTV_{CC} pins together and tie the combined pins to the 5V input with a 1Ω or 2.2Ω resistor as shown in Figure 11 to minimize the voltage drop caused by the gate charge current. This will override the INTV_{CC} linear regulator and will prevent INTV_{CC} from dropping too low due to the dropout voltage. Make sure the INTV_{CC} voltage is at or exceeds the R_{DS(ON)} test voltage for the MOSFET which is typically 4.5V for logic level devices.

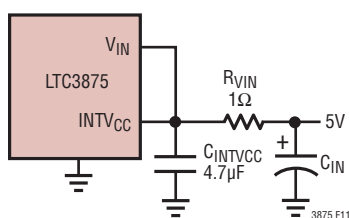

Figure 11. Setup for a 5V Input

Topside MOSFET Driver Supply (C_B, D_B)

External bootstrap capacitor, C_B, connected to the BOOST pin supplies the gate drive voltages for the topside MOSFET. Capacitor C_B in the Functional Diagram is charged through external diode D_B from INTV_{CC} when the SW pin is low. When the topside MOSFET is to be turned on, the driver places the C_B voltage across the gate source of the

MOSFET. This enhances the MOSFET and turns on the topside switch. The switch node voltage, SW, rises to V_{IN} and the BOOST pin follows. With the topside MOSFET on, the boost voltage is above the input supply:

$$V_{\text{BOOST}} = V_{\text{IN}} + V_{\text{INTVCC}} - V_{\text{DB}}$$

where V_{DB} is the diode forward voltage drop.

The value of the boost capacitor, C_B, needs to be 100 times that of the total input capacitance of the topside MOSFET(s). The reverse breakdown of the external Schottky diode must be greater than V_{IN(MAX)}. When adjusting the gate drive level, the final arbiter is the total input current for the regulator. If a change is made and the input current decreases, then the efficiency has improved. If there is no change in input current, then there is no change in efficiency.

Undervoltage Lockout

The LTC3875 has two functions that help protect the controller in case of undervoltage conditions. A precision UVLO comparator constantly monitors the INTV_{CC} voltage to ensure that an adequate gate-drive voltage is present. It locks out the switching action when INTV_{CC} is below 3.7V. To prevent oscillation when there is a disturbance on the INTV_{CC}, the UVLO comparator has 500mV of precision hysteresis.

Another way to detect an undervoltage condition is to monitor the V_{IN} supply. Because the RUN pins have a precision turn-on reference of 1.22V, one can use a resistor divider to V_{IN} to turn on the IC when V_{IN} is high enough. An extra 4.5μA of current flows out of the RUN pin once the RUN pin voltage passes 1.22V. One can program the hysteresis of the run comparator by adjusting the values of the resistive divider. For accurate V_{IN} undervoltage detection, V_{IN} needs to be higher than 4.5V.

C_{IN} and C_{OUT} Selection

The selection of C_{IN} is simplified by the 2-phase architecture and its impact on the worst-case RMS current drawn through the input network (battery/fuse/capacitor). It can be shown that the worst-case capacitor RMS current occurs when only one controller is operating. The controller with the highest (V_{OUT})(I_{OUT}) product needs to be used

APPLICATIONS INFORMATION

in the formula below to determine the maximum RMS capacitor current requirement. Increasing the output current drawn from the other controller will actually decrease the input RMS ripple current from its maximum value. The out-of-phase technique typically reduces the input capacitor's RMS ripple current by a factor of 30% to 70% when compared to a single phase power supply solution.

In continuous mode, the source current of the top MOSFET is a square wave of duty cycle $(V_{OUT})/(V_{IN})$. To prevent large voltage transients, a low ESR capacitor sized for the maximum RMS current of one channel must be used. The maximum RMS capacitor current is given by:

$$C_{IN} \text{ Required } I_{RMS} \approx \frac{I_{MAX}}{V_{IN}} [(V_{OUT})(V_{IN} - V_{OUT})]^{1/2}$$

This formula has a maximum at $V_{IN} = 2V_{OUT}$, where $I_{RMS} = I_{OUT}/2$. This simple worst-case condition is commonly used for design because even significant deviations do not offer much relief. Note that capacitor manufacturers' ripple current ratings are often based on only 2000 hours of life. This makes it advisable to further derate the capacitor, or to choose a capacitor rated at a higher temperature than required. Several capacitors may be paralleled to meet size or height requirements in the design. Due to the high operating frequency of the LTC3875, ceramic capacitors can also be used for C_{IN} . Always consult the manufacturer if there is any question.

The benefit of the LTC3875 2-phase operation can be calculated by using the equation above for the higher power controller and then calculating the loss that would have resulted if both controller channels switched on at the same time. The total RMS power lost is lower when both controllers are operating due to the reduced overlap of current pulses required through the input capacitor's ESR. This is why the input capacitor's requirement calculated above for the worst-case controller is adequate for the dual controller design. Also, the input protection fuse resistance, battery resistance, and PC board trace resistance losses are also reduced due to the reduced peak currents in a 2-phase system. The overall benefit of a multiphase design will only be fully realized when the source impedance of the power supply/battery is included in the efficiency testing. The sources of the top MOSFETs

should be placed within 1cm of each other and share a common $C_{IN}(s)$. Separating the sources and C_{IN} may produce undesirable voltage and current resonances at V_{IN} .

A small (0.1 μ F to 1 μ F) bypass capacitor between the chip V_{IN} pin and ground, placed close to the LTC3875, is also suggested. A 2.2 Ω to 10 Ω resistor placed between C_{IN} and the V_{IN} pin provides further isolation between the two channels.

The selection of C_{OUT} is driven by the effective series resistance (ESR). Typically, once the ESR requirement is satisfied, the capacitance is adequate for filtering. The output ripple (ΔV_{OUT}) is approximated by:

$$\Delta V_{OUT} \approx I_{RIPPLE} \left(ESR + \frac{1}{8fC_{OUT}} \right)$$

where f is the operating frequency, C_{OUT} is the output capacitance and I_{RIPPLE} is the ripple current in the inductor. The output ripple is highest at maximum input voltage since I_{RIPPLE} increases with input voltage.

Setting Output Voltage

The LTC3875 output voltages are each set by an external feedback resistive divider carefully placed across the output, as shown in Figure 1. The regulated output voltage is determined by:

$$V_{OUT} = 0.6V \cdot \left(1 + \frac{R_{D1}}{R_{D2}} \right)$$

To improve the frequency response, a feed-forward capacitor, C_{FF} , may be used. Great care should be taken to route the V_{FB} line away from noise sources, such as the inductor or the SW line.

Fault Conditions: Current Limit and Current Foldback

The LTC3875 includes current foldback to help limit load current when the output is shorted to ground. If the output falls below 50% of its nominal output level, then the maximum sense voltage is progressively lowered from its maximum programmed value to one-third of the maximum value. Foldback current limiting is disabled during the soft-start or tracking up. Under short-circuit conditions

APPLICATIONS INFORMATION

with very low duty cycles, the LTC3875 will begin cycle skipping in order to limit the short-circuit current. In this situation the bottom MOSFET will be dissipating most of the power but less than in normal operation. The short-circuit ripple current is determined by the minimum on-time, $t_{ON(MIN)}$, of the LTC3875 ($\approx 90\text{ns}$), the input voltage and inductor value:

$$\Delta I_{L(SC)} = t_{ON(MIN)} \cdot \frac{V_{IN}}{L}$$

The resulting short-circuit current is:

$$I_{SC} = \frac{1/3 V_{SENSE(MAX)}}{R_{SENSE}} - \frac{1}{2} \Delta I_{L(SC)}$$

Overcurrent Fault Recovery

When the output of the power supply is loaded beyond its preset current limit, the regulated output voltage will collapse depending on the load. The output may be shorted to ground through a very low impedance path or it may be a resistive short, in which case the output will collapse partially, until the load current equals the preset current limit. The controller will continue to source current into the short. The amount of current sourced depends on the ILIM pin setting and the V_{FB} voltage as shown in the Current Foldback graph in the Typical Performance Characteristics section. Upon removal of the short, the output soft starts using the internal soft-start, thus reducing output overshoot. In the absence of this feature, the output capacitors would have been charged at current limit, and in applications with minimal output capacitance this may have resulted in output overshoot. Current limit foldback is not disabled during an overcurrent recovery. The load must step below the folded back current limit threshold in order to restart from a hard short.

Thermal Protection

Excessive ambient temperatures, loads and inadequate airflow or heat sinking can subject the chip, inductor, FETs etc. to high temperatures. This thermal stress reduces component life and if severe enough, can result in immediate catastrophic failure (Note 1). To protect the power supply from undue thermal stress, the LTC3875 has a fixed chip temperature-based thermal shutdown.

The internal thermal shutdown is set for approximately 160°C with 10°C of hysteresis. When the chip reaches 160°C , both TG and BG are disabled until the chip cools down below 150°C .

Phase-Locked Loop and Frequency Synchronization

The LTC3875 has a phase-locked loop (PLL) comprised of an internal voltage-controlled oscillator (V_{CO}) and a phase detector. This allows the turn-on of the top MOSFET of controller 1 to be locked to the rising edge of an external clock signal applied to the MODE/PLLIN pin. The turn-on of controller 2's top MOSFET is thus 180° out-of-phase with the external clock. The phase detector is an edge sensitive digital type that provides zero degrees phase shift between the external and internal oscillators. This type of phase detector does not exhibit false lock to harmonics of the external clock.

The output of the phase detector is a pair of complementary current sources that charge or discharge the internal filter network. There is a precision $10\mu\text{A}$ of current flowing out of FREQ pin. This allows the user to use a single resistor to SGND to set the switching frequency when no external clock is applied to the MODE/PLLIN pin. The internal switch between FREQ pin and the integrated PLL filter network is on, allowing the filter network to be precharged to the same voltage potential as the FREQ pin. The relationship between the voltage on the FREQ pin and the operating frequency is shown in Figure 12 and specified in the Electrical Characteristic table. If an external clock is detected on the MODE/PLLIN pin, the internal switch mentioned above will turn off and isolate the influence of FREQ pin. Note that the LTC3875 can only be synchronized to an external clock whose frequency is within range of the LTC3875's internal V_{CO} . This is guaranteed to be between 250kHz and 720kHz . A simplified block diagram is shown in Figure 13.

If the external clock frequency is greater than the internal oscillator's frequency, f_{OSC} , then current is sourced continuously from the phase detector output, pulling up the filter network. When the external clock frequency is less than f_{OSC} , current is sunk continuously, pulling down the filter network. If the external and internal frequencies are the same but exhibit a phase difference, the current sources turn on for an amount of time corresponding to

APPLICATIONS INFORMATION

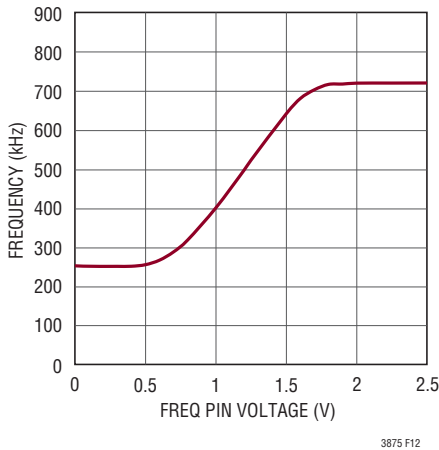

Figure 12. Relationship Between Oscillator Frequency and Voltage at the FREQ Pin

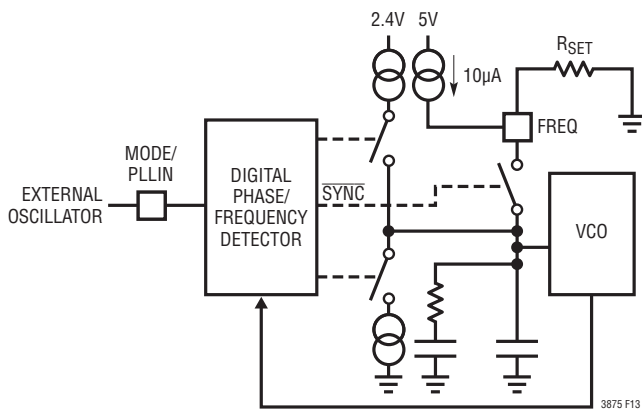

Figure 13. Phase-Locked Loop Block Diagram

the phase difference. The voltage on the filter network is adjusted until the phase and frequency of the internal and external oscillators are identical. At the stable operating point, the phase detector output is high impedance and the filter capacitor holds the voltage.

Typically, the external clock (on MODE/PLLIN pin) input high threshold is 1.6V, while the input low threshold is 1V. It is not recommended to apply the external clock when IC is in shutdown.

Minimum On-Time Considerations

Minimum on-time, $t_{ON(MIN)}$, is the smallest time duration that the LTC3875 is capable of turning on the top MOSFET. It is determined by internal timing delays and the gate charge required to turn on the top MOSFET. Low duty

cycle applications may approach this minimum on-time limit and care should be taken to ensure that:

$$t_{ON(MIN)} < \frac{V_{OUT}}{(V_{IN} \cdot f)}$$

If the duty cycle falls below what can be accommodated by the minimum on-time, the controller will begin to skip cycles. The output voltage will continue to be regulated, but the ripple voltage and current will increase. The minimum on-time for the LTC3875 is approximately 90ns, with reasonably good PCB layout, minimum 30% inductor current ripple and at least 2mV ripple on the current sense signal or equivalent 10mV between SNSA⁺ and SNS⁻ pins. The minimum on-time can be affected by PCB switching noise in the voltage and current loop. As the peak sense voltage decreases the minimum on-time gradually increases to 110ns. This is of particular concern in forced continuous applications with low ripple current at light loads. If the duty cycle drops below the minimum on-time limit in this situation, a significant amount of cycle skipping can occur with correspondingly larger current and voltage ripple.

Efficiency Considerations

The percent efficiency of a switching regulator is equal to the output power divided by the input power times 100%. It is often useful to analyze individual losses to determine what is limiting the efficiency and which change would produce the most improvement. Percent efficiency can be expressed as:

$$\% \text{Efficiency} = 100\% - (L1 + L2 + L3 + \dots)$$

where L1, L2, etc. are the individual losses as a percentage of input power.

Although all dissipative elements in the circuit produce losses, four main sources usually account for most of the losses in LTC3875 circuits: 1) IC V_{IN} current, 2) INTV_{CC} regulator current, 3) I^2R losses, 4) Topside MOSFET transition losses.

1. The V_{IN} current is the DC supply current given in the Electrical Characteristics table, which excludes MOSFET driver and control currents. V_{IN} current typically results in a small (<0.1%) loss.

APPLICATIONS INFORMATION

- INTV_{CC} current is the sum of the MOSFET driver and control currents. The MOSFET driver current results from switching the gate capacitance of the power MOSFETs. Each time a MOSFET gate is switched from low to high to low again, a packet of charge dQ moves from INTV_{CC} to ground. The resulting dQ/dt is a current out of INTV_{CC} that is typically much larger than the control circuit current. In continuous mode, I_{GATECHG} = f(QT + QB), where QT and QB are the gate charges of the topside and bottom side MOSFETs.

Supplying INTV_{CC} power through EXTV_{CC} from an output-derived source will scale the V_{IN} current required for the driver and control circuits by a factor of (Duty Cycle)/(Efficiency). For example, in a 20V to 5V application, 10mA of INTV_{CC} current results in approximately 2.5mA of V_{IN} current. This reduces the midcurrent loss from 10% or more (if the driver was powered directly from V_{IN}) to only a few percent.

- I²R losses are predicted from the DC resistances of the fuse (if used), MOSFET, inductor, current sense resistor (if used). In continuous mode, the average output current flows through L, but is “chopped” between the topside MOSFET and the synchronous MOSFET. If the two MOSFETs have approximately the same R_{DS(ON)}, then the resistance of one MOSFET can simply be summed with the resistances of L to obtain I²R losses. Efficiency varies as the inverse square of V_{OUT} for the same external components and output power level. The combined effects of increasingly lower output voltages and higher currents required by high performance digital systems is not doubling but quadrupling the importance of loss terms in the switching regulator system!
- Transition losses apply only to the topside MOSFET(s), and become significant only when operating at high input voltages (typically 15V or greater). Transition losses can be estimated from:

$$\text{Transition Loss} = (1.7) V_{IN}^2 I_{O(MAX)} C_{RSS} f$$

Other “hidden” losses such as copper trace and internal battery resistances can account for an additional efficiency degradation in portable systems. It is very important to include these “system” level losses during the design

phase. The internal battery and fuse resistance losses can be minimized by making sure that C_{IN} has adequate charge storage and very low ESR at the switching frequency. The LTC3875 2-phase architecture typically halves this input capacitance requirement over competing solutions. Other losses including Schottky conduction losses during dead time and inductor core losses generally account for less than 2% total additional loss.

Checking Transient Response

The regulator loop response can be checked by looking at the load current transient response. Switching regulators take several cycles to respond to a step in DC (resistive) load current. When a load step occurs, V_{OUT} shifts by an amount equal to $\Delta I_{LOAD} (ESR)$, where ESR is the effective series resistance of C_{OUT}. ΔI_{LOAD} also begins to charge or discharge C_{OUT} generating the feedback error signal that forces the regulator to adapt to the current change and return V_{OUT} to its steady-state value. During this recovery time V_{OUT} can be monitored for excessive overshoot or ringing, which would indicate a stability problem. The availability of the I_{TH} pin not only allows optimization of control loop behavior but also provides a DC-coupled and AC-filtered closed-loop response test point. The DC step, rise time and settling at this test point truly reflects the closed loop response. Assuming a predominantly second order system, phase margin and/or damping factor can be estimated using the percentage of overshoot seen at this pin. The bandwidth can also be estimated by examining the rise time at the pin. The I_{TH} external components shown in the Typical Application circuit will provide an adequate starting point for most applications. The I_{TH} series R_C-C_C filter sets the dominant pole-zero loop compensation. The values can be modified slightly (from 0.5 to 2 times their suggested values) to optimize transient response once the final PC layout is done and the particular output capacitor type and value have been determined. The output capacitors need to be selected because the various types and values determine the loop gain and phase. An output current pulse of 20% to 80% of full-load current having a rise time of 1μs to 10μs will produce output voltage and I_{TH} pin waveforms that will give a sense of the overall loop stability without breaking the feedback loop. Placing

APPLICATIONS INFORMATION

a power MOSFET directly across the output capacitor and driving the gate with an appropriate signal generator is a practical way to produce a realistic load-step condition. The initial output voltage step resulting from the step change in output current may not be within the bandwidth of the feedback loop, so this signal cannot be used to determine phase margin. This is why it is better to look at the I_{TH} pin signal which is in the feedback loop and is the filtered and compensated control loop response. The gain of the loop will be increased by increasing R_C and the bandwidth of the loop will be increased by decreasing C_C . If R_C is increased by the same factor that C_C is decreased, the zero frequency will be kept the same, thereby keeping the phase shift the same in the most critical frequency range of the feedback loop. The output voltage settling behavior is related to the stability of the closed-loop system and will demonstrate the actual overall supply performance.

A second, more severe transient is caused by switching in loads with large ($>1\mu\text{F}$) supply bypass capacitors. The discharged bypass capacitors are effectively put in parallel with C_{OUT} , causing a rapid drop in V_{OUT} . No regulator can alter its delivery of current quickly enough to prevent this sudden step change in output voltage if the load switch resistance is low and it is driven quickly. If the ratio of C_{LOAD} to C_{OUT} is greater than 1:50, the switch rise time should be controlled so that the load rise time is limited to approximately $25 \cdot C_{LOAD}$. Thus a $10\mu\text{F}$ capacitor would require a $250\mu\text{s}$ rise time, limiting the charging current to about 200mA.

PC Board Layout Checklist

When laying out the printed circuit board, the following checklist should be used to ensure proper operation of the IC. These items are also illustrated graphically in the layout diagram of Figure 14. Figure 15 illustrates the current waveforms present in the various branches of the 2-phase synchronous regulators operating in the continuous mode. Check the following in your layout:

1. Are the top N-channel MOSFETs M1 and M3 located within 1cm of each other with a common drain connection at C_{IN} ? Do not attempt to split the input decoupling for the two channels as it can cause a large resonant loop.
2. Are the signal and power grounds kept separate? The combined IC signal ground pin and the ground return of C_{INTVCC} must return to the combined C_{OUT} (-) terminals. The V_{FB} and I_{TH} traces should be as short as possible. The path formed by the top N-channel MOSFET, Schottky diode and the C_{IN} capacitor should have short leads and PC trace lengths. The output capacitor (-) terminals should be connected as close as possible to the (-) terminals of the input capacitor by placing the capacitors next to each other and away from the Schottky loop described above.
3. Are the $SNSD^+$, $SNSA^+$ and SNS^- printed circuit traces routed together with minimum PC trace spacing? The filter capacitors between $SNSD^+$, $SNSA^+$ and SNS^- should be as close as possible to the pins of the IC. Connect the $SNSD^+$ and $SNSA^+$ pins to the filter resistors as illustrated in Figure 4.
4. Do the (+) plates of C_{IN} connect to the drain of the topside MOSFET as closely as possible? This capacitor provides the pulsed current to the MOSFET.
5. Keep the switching nodes, SW, BOOST and TG away from sensitive small-signal nodes ($SNSD^+$, $SNSA^+$, SNS^- , V_{OSNS^+} , V_{OSNS^-}). Ideally the SW, BOOST and TG printed circuit traces should be routed away and separated from the IC and especially the quiet side of the IC. Separate the high dv/dt traces from sensitive small-signal nodes with ground traces or ground planes.
6. The $INTV_{CC}$ decoupling capacitor should be placed immediately adjacent to the IC between the $INTV_{CC}$ pin and PGND plane. A $1\mu\text{F}$ ceramic capacitor of the X7R or X5R type is small enough to fit very close to the IC to minimize the ill effects of the large current pulses drawn to drive the bottom MOSFETs. An additional $4.7\mu\text{F}$ to $10\mu\text{F}$ of ceramic, tantalum or other very low ESR capacitance is recommended in order to keep the internal IC supply quiet.
7. Use a modified "star ground" technique: a low impedance, large copper area central grounding point on the same side of the PC board as the input and output capacitors with tie-ins for the bottom of the $INTV_{CC}$ decoupling capacitor, the bottom of the voltage feedback resistive divider and the SGND pin of the IC.

APPLICATIONS INFORMATION

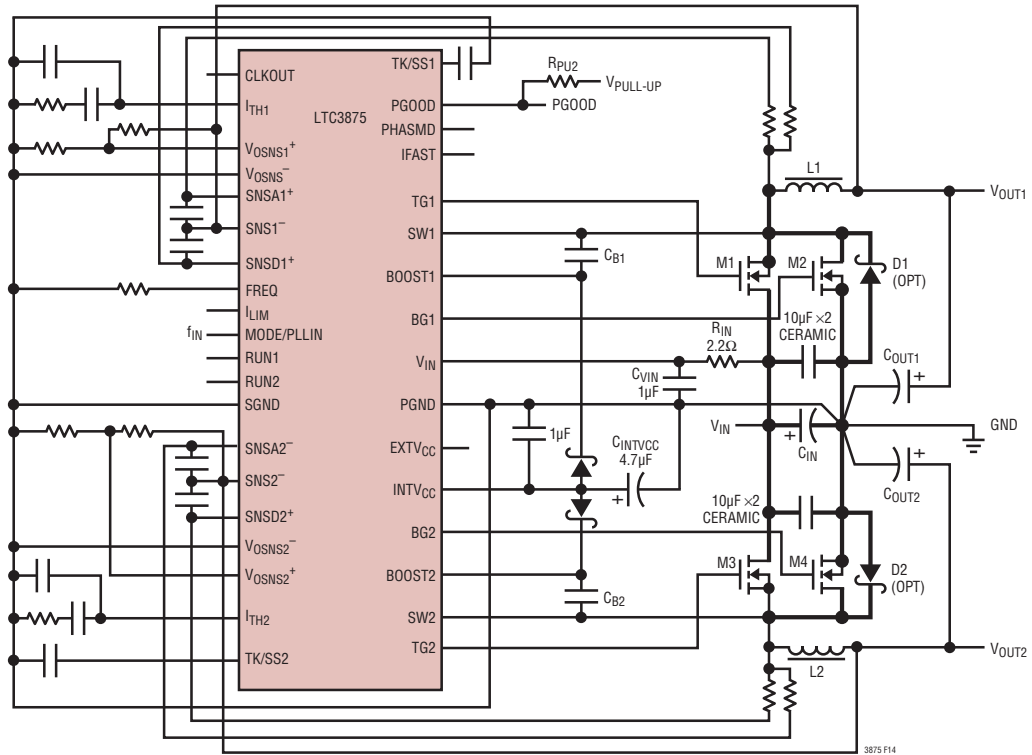

Figure 14. Recommended Printed Circuit Layout Diagram

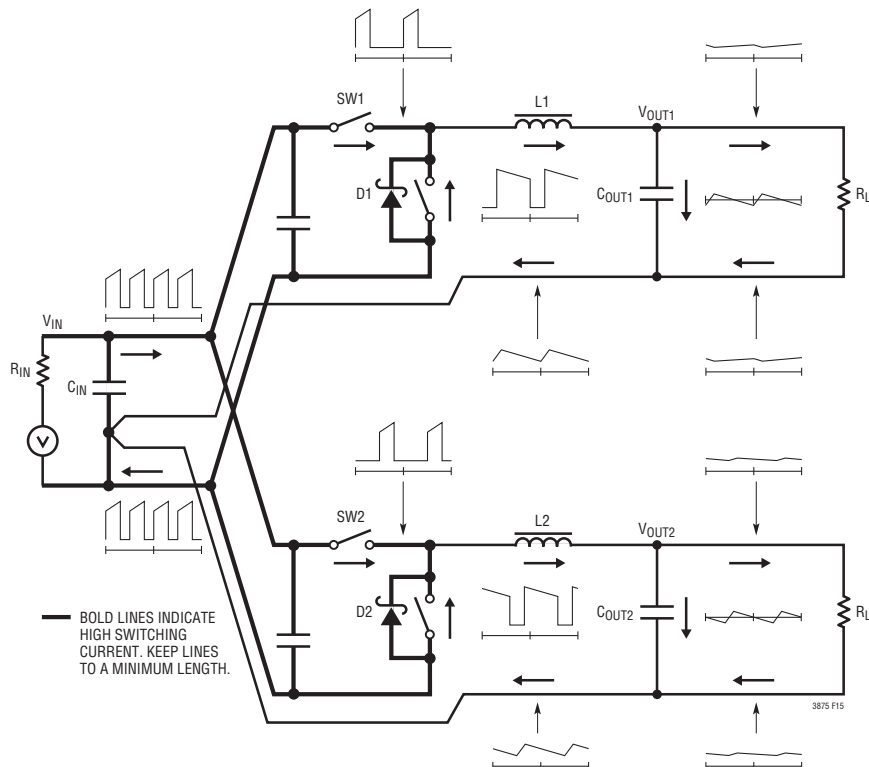

Figure 15. Branch Current Waveforms

APPLICATIONS INFORMATION

8. Use a low impedance source such as a logic gate to drive the MODE/PLLIN pin and keep the lead as short as possible.
9. The 47pF to 330pF ceramic capacitor between the ITH pin and signal ground should be placed as close as possible to the IC. Figure 15 illustrates all branch currents in a switching regulator. It becomes very clear after studying the current waveforms why it is critical to keep the high switching current paths to a small physical size. High electric and magnetic fields will radiate from these loops just as radio stations transmit signals. The output capacitor ground should return to the negative terminal of the input capacitor and not share a common ground path with any switched current paths. The left half of the circuit gives rise to the noise generated by a switching regulator. The ground terminations of the synchronous MOSFET and Schottky diode should return to the bottom plate(s) of the input capacitor(s) with a short isolated PC trace since very high switched currents are present. External OPTI-LOOP[®] compensation allows overcompensation for PC layouts which are not optimized but this is not the recommended design procedure.

PC Board Layout Debugging

Start with one controller at a time. It is helpful to use a DC-50MHz current probe to monitor the current in the inductor while testing the circuit. Monitor the output switching node (SW pin) to synchronize the oscilloscope to the internal oscillator and probe the actual output voltage as well. Check for proper performance over the operating voltage and current range expected in the application. The frequency of operation should be maintained over the input voltage range down to dropout and until the output load drops below the low current operation threshold—typically 10% of the maximum designed current level in Burst Mode[®] operation. The duty cycle percentage should be maintained from cycle to cycle in a well-designed, low noise PCB implementation. Variation in the duty cycle at a sub-harmonic rate can suggest noise pickup at the current or voltage sensing inputs or inadequate loop compensation. Overcompensation of the loop can be used to tame a poor PC layout if regulator bandwidth optimization is

not required. Only after each controller is checked for its individual performance should both controllers be turned on at the same time. A particularly difficult region of operation is when one controller channel is nearing its current comparator trip point when the other channel is turning on its top MOSFET. This occurs around 50% duty cycle on either channel due to the phasing of the internal clocks and may cause minor duty cycle jitter.

Reduce V_{IN} from its nominal level to verify operation of the regulator in dropout. Check the operation of the undervoltage lockout circuit by further lowering V_{IN} while monitoring the outputs to verify operation.

Investigate whether any problems exist only at higher output currents or only at higher input voltages. If problems coincide with high input voltages and low output currents, look for capacitive coupling between the BOOST, SW, TG, and possibly BG connections and the sensitive voltage and current pins. The capacitor placed across the current sensing pins needs to be placed immediately adjacent to the pins of the IC. This capacitor helps to minimize the effects of differential noise injection due to high frequency capacitive coupling. If problems are encountered with high current output loading at lower input voltages, look for inductive coupling between C_{IN} , Schottky and the top MOSFET components to the sensitive current and voltage sensing traces. In addition, investigate common ground path voltage pickup between these components and the SGND pin of the IC.

Design Example

As a design example for a single output dual phase high current regulator, assume $V_{IN} = 12V$ (nominal), $V_{IN} = 20V$ (maximum), $V_{OUT} = 1.5V$, $I_{MAX1,2} = 30A$, and $f = 400kHz$ (see Figure 16).

The regulated output voltages are determined by:

$$V_{OUT} = 0.6 \cdot \left(1 + \frac{R_B}{R_A} \right)$$

Shorting the V_{OSNS1}^+ pins and V_{OSNS2}^+ pins together. Using 20k, 1% resistor from V_{OSNS}^+ node to remote ground, the top feedback resistor is (to the nearest 1% standard value) 30.1k.

APPLICATIONS INFORMATION

Choose $R_1 = 4.64k$ and $R_2 = 931\Omega$.

The maximum DCR of the inductor is $0.34m\Omega$. The $V_{SENSE(MAX)}$ is calculated as:

$$V_{SENSE(MAX)} = I_{PEAK} \cdot DCR (Max) = 12mV$$

The current limit is chosen to be $15mV$. If temperature variation is considered, please refer to Inductor DCR Sensing Temperature Compensation with NTC Thermistor.

The power dissipation on the topside MOSFET can be easily estimated. Choosing an Infineon BSC050NE2LS MOSFET results in: $R_{DS(ON)} = 7.1m\Omega$ (max), $V_{MILLER} = 2.8V$, $C_{MILLER} \cong 35pF$. At maximum input voltage with T_J (estimated) = $75^\circ C$:

$$\begin{aligned} P_{MAIN} &= \frac{1.5V}{20V} (30A)^2 [1 + (0.005)(75^\circ C - 25^\circ C)] \cdot \\ &\quad (0.0071\Omega) + (20V)^2 \left(\frac{30A}{2} \right) (2\Omega) (35pF) \cdot \\ &\quad \left[\frac{1}{5.5V - 2.8V} + \frac{1}{2.8V} \right] (400kHz) \\ &= 599mW + 122mW \\ &= 721mW \end{aligned}$$

For a $0.32m\Omega$ DCR, a short-circuit to near ground will result in a folded back current of:

$$I_{SC} = \frac{(1/3)15mV}{0.0032\Omega} - \frac{1}{2} \left(\frac{90ns(20V)}{0.33\mu H} \right) = 12.9A$$

An Infineon BSC010NE2LS, $R_{DS(ON)} = 1.1m\Omega$, is chosen for the bottom FET. The resulting power loss is:

$$\begin{aligned} P_{SYNC} &= \frac{20V - 1.5V}{20V} (30A)^2 \cdot \\ &\quad [1 + (0.005) \cdot (75^\circ C - 25^\circ C)] \cdot 0.001\Omega \\ P_{SYNC} &= 1.14W \end{aligned}$$

C_{IN} is chosen for an equivalent RMS current rating of at least $13.7A$. C_{OUT} is chosen with an equivalent ESR of $4.5m\Omega$ for low output ripple. The output ripple in continuous mode will be highest at the maximum input voltage.

The output voltage ripple due to ESR is approximately:

$$V_{ORIPPLE} = R_{ESR} (\Delta I_L) = 0.0045\Omega \cdot 10A = 45mV_{P-P}$$

Further reductions in output voltage ripple can be made by placing a $100\mu F$ ceramic capacitor across C_{OUT} .

Thermal Balancing Converter Example

If thermal balancing function is desired, connecting ENTMPB pin to ground enables the temperature balancing function, but disables the inductor DCR sensing temperature compensation function. For a 4-phase design select $TRSET_{1,2,3,4} = 10k$, then $R_{TAVG} = 2.5k$. The resistance vs temperature slope of NTC connected to the TCOMP pin need to be modified according to the inductor current correction range. Please refer to temperature balancing with NTC thermistor example shown in Figure 17.

TYPICAL APPLICATIONS

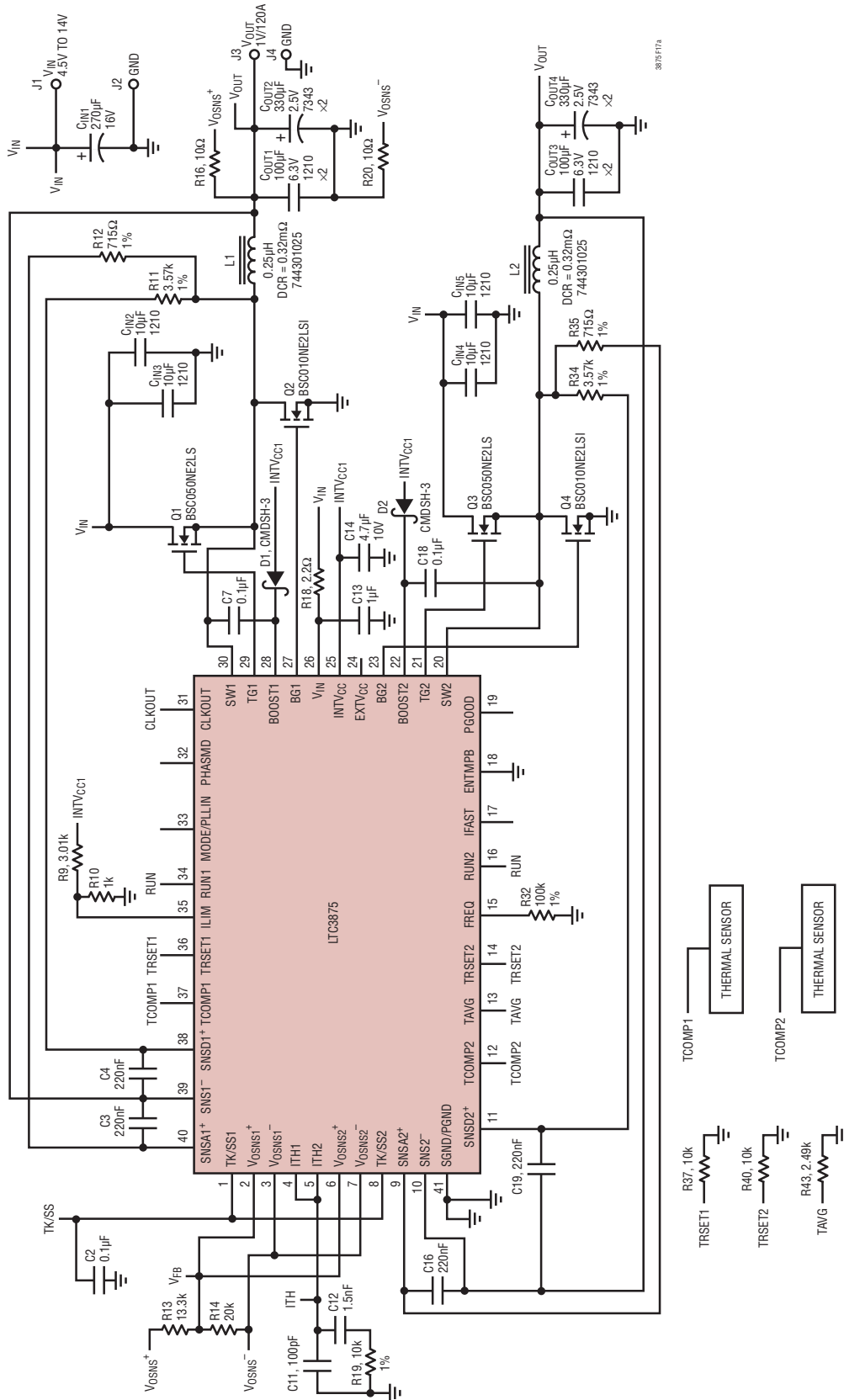
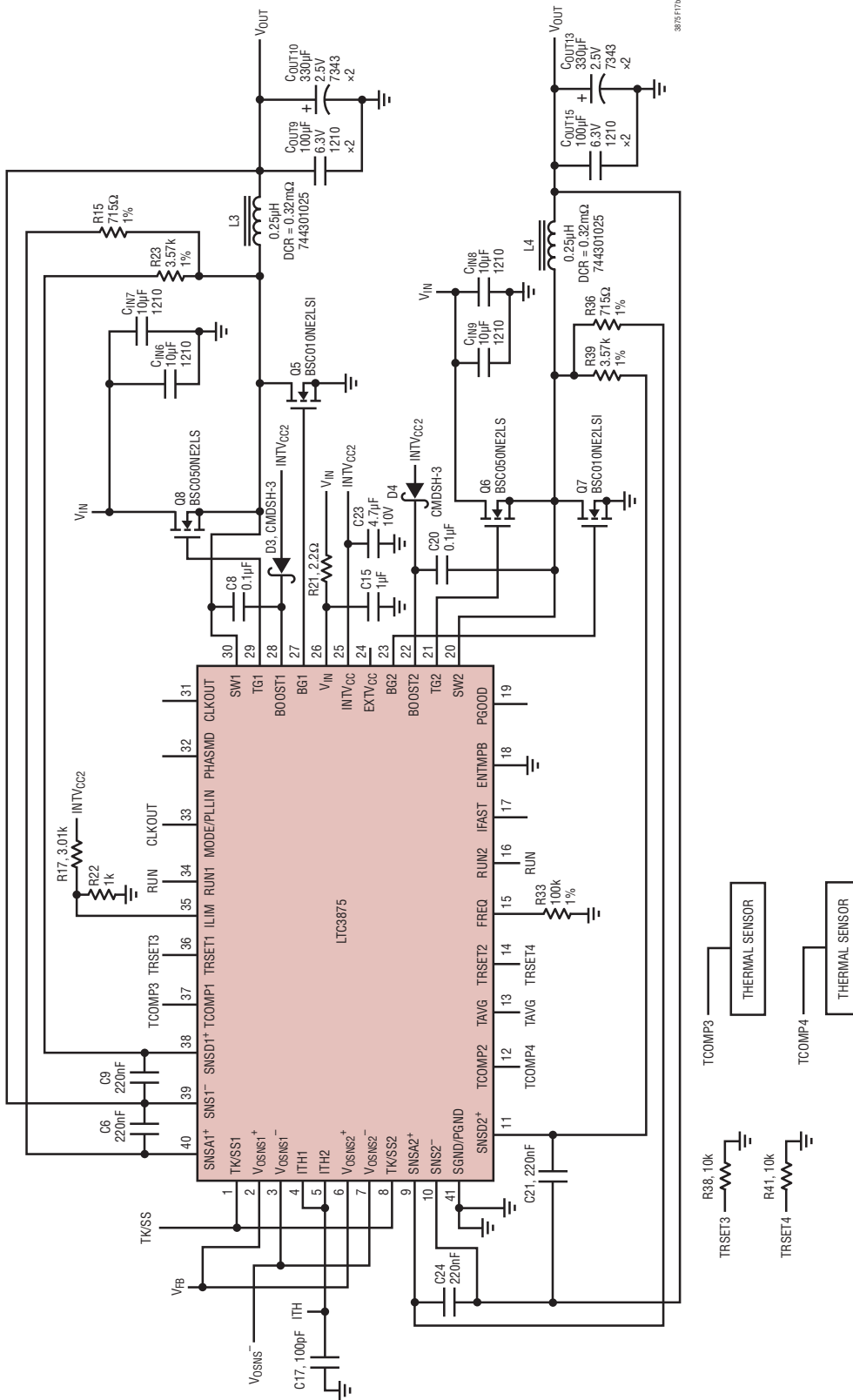

Figure 17a. 4-Phase 1.0V/120A Step-Down Converter with Thermal Balancing

TYPICAL APPLICATIONS



TYPICAL APPLICATIONS

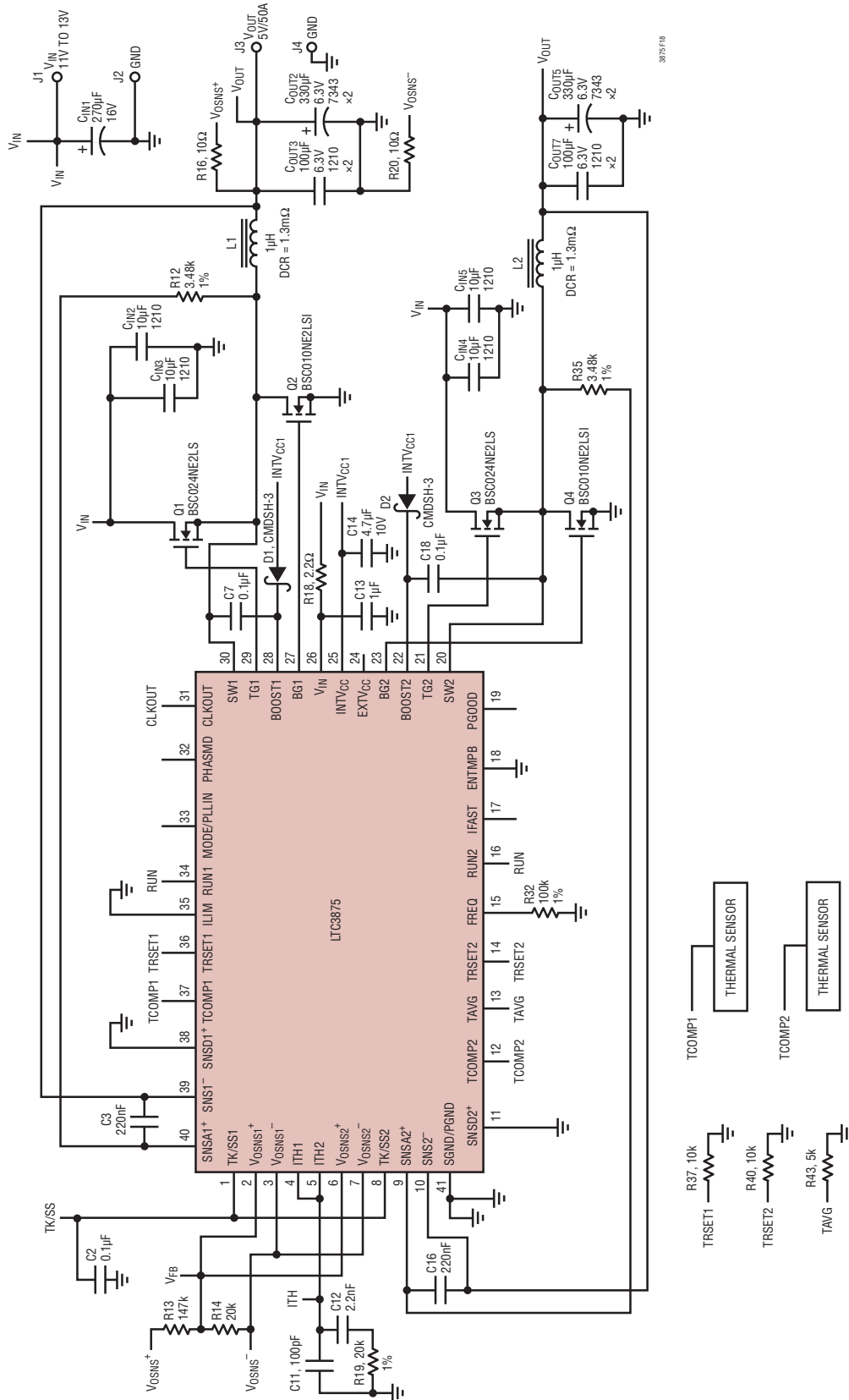

Figure 18. 5.0V/50A 2-Phase Step-Down Converter with Remote Sensing

TYPICAL APPLICATIONS

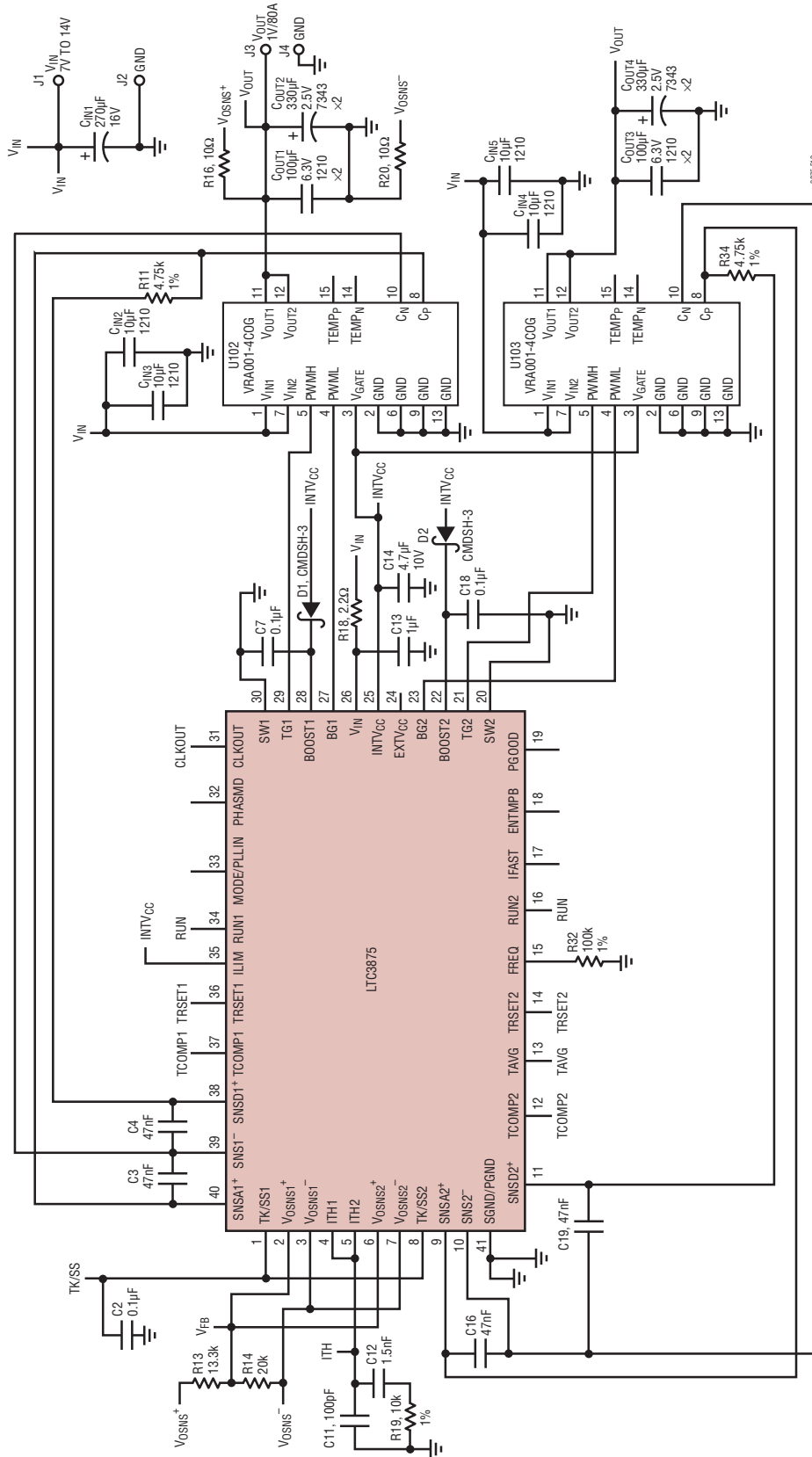

Figure 19. 1.0V/80A 2-Phase High Efficiency Step-Down Converter with AcBel Power Block

TYPICAL APPLICATIONS

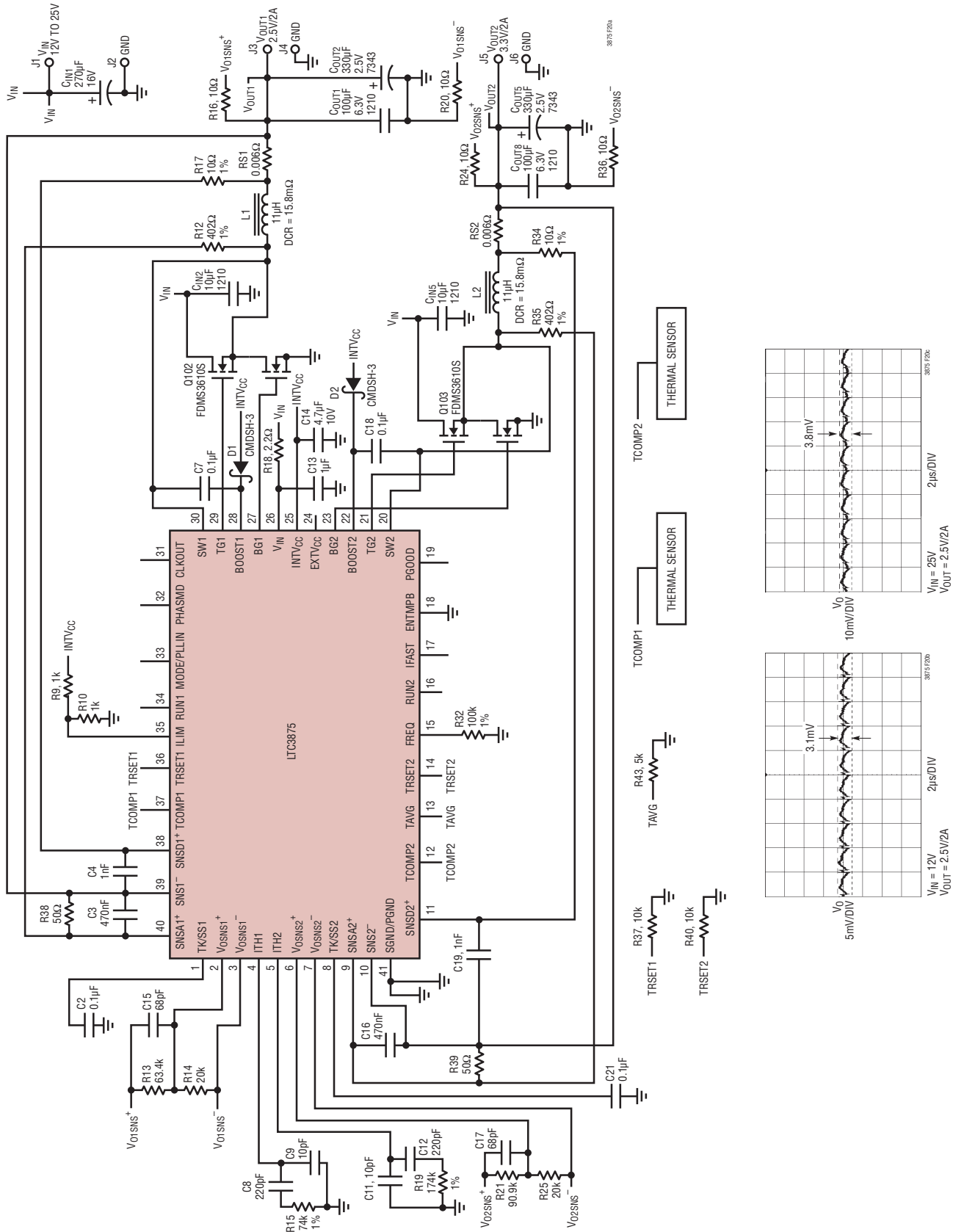
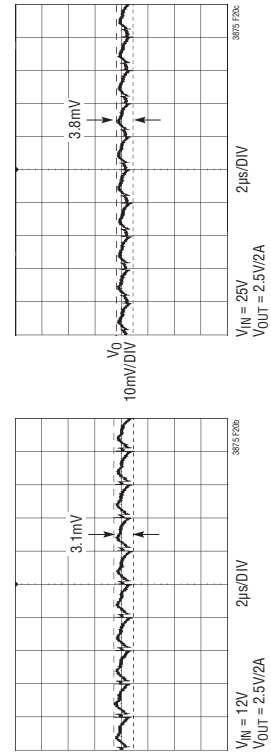

Figure 20. Dual Output Ultralow Ripple 2.5V/2A, 3.3V/2A Step-Down Converter



TYPICAL APPLICATIONS

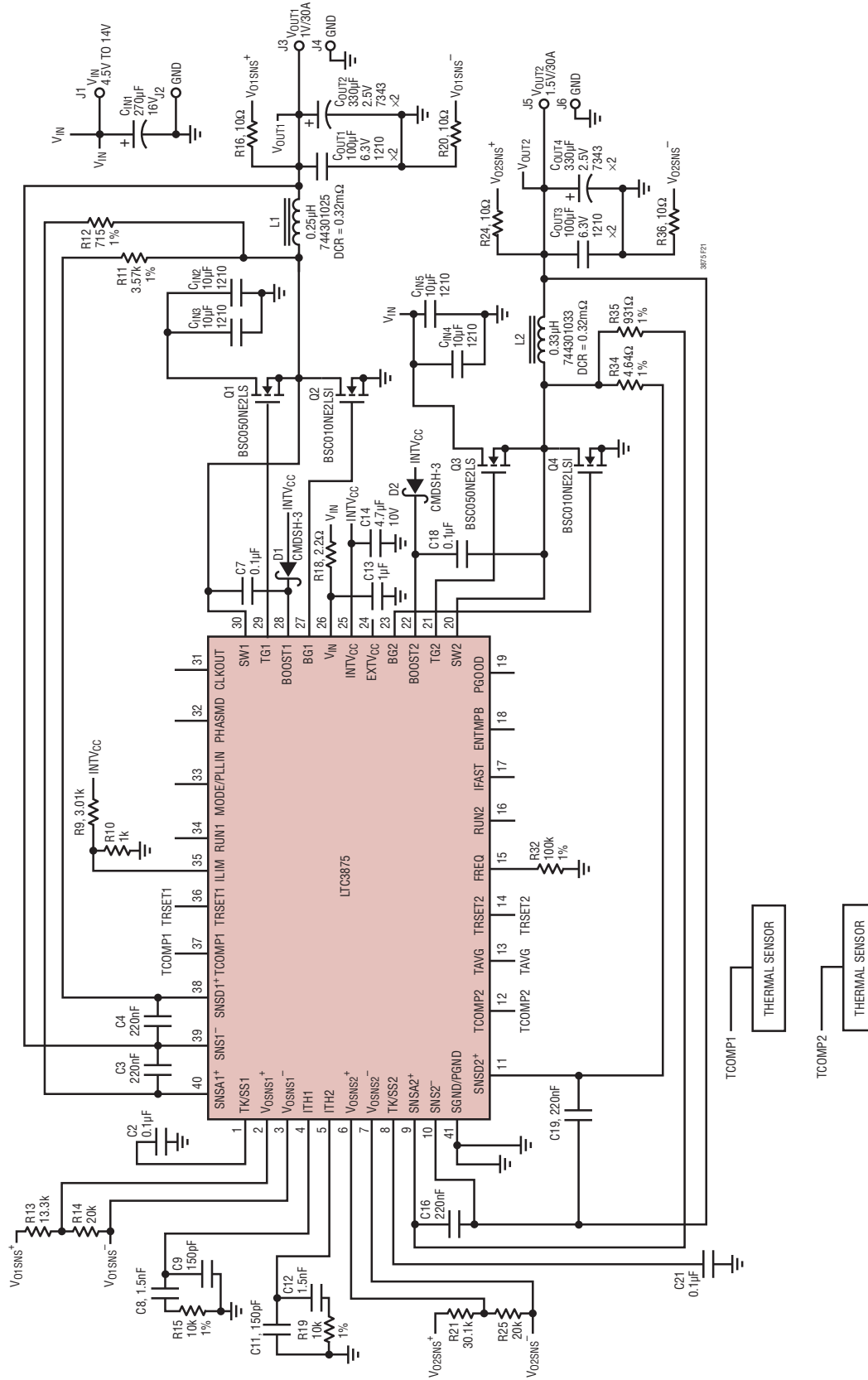
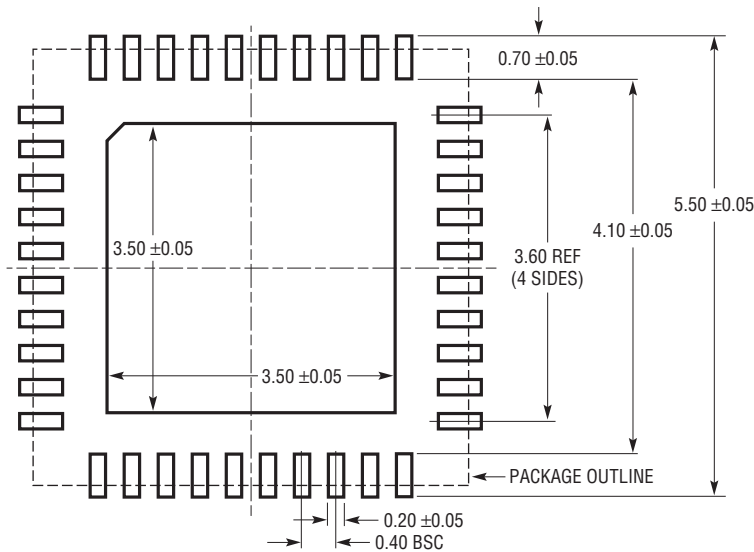

Figure 21. Dual Output 1V/30A, 1.5V/30A Step-Down Converter with Remote Sensing

PACKAGE DESCRIPTION

Please refer to <http://www.linear.com/product/LTC3875#packaging> for the most recent package drawings.

UH Package
40-Lead Plastic QFN (5mm × 5mm)
 (Reference LTC DWG # 05-08-1746 Rev B)



RECOMMENDED SOLDER PAD PITCH AND DIMENSIONS
 APPLY SOLDER MASK TO AREAS THAT ARE NOT SOLDERED

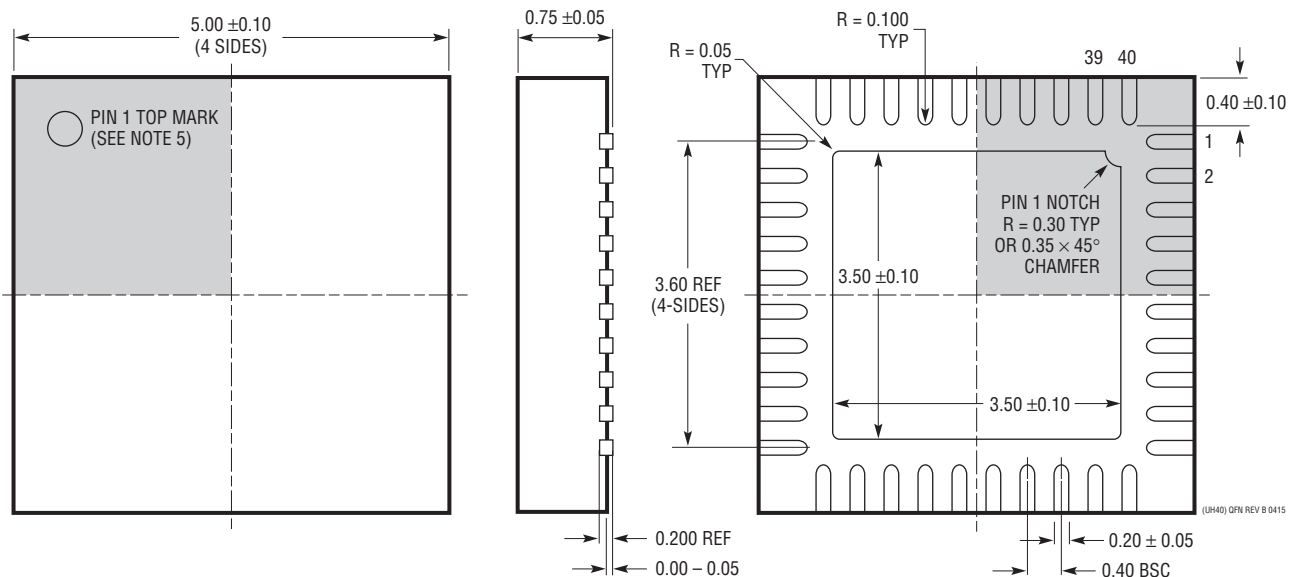

- NOTE:
1. DRAWING CONFIRMS TO JEDEC PACKAGE OUTLINE MO-220
 2. ALL DIMENSIONS ARE IN MILLIMETERS
 3. DIMENSIONS OF EXPOSED PAD ON BOTTOM OF PACKAGE DO NOT INCLUDE MOLD FLASH. MOLD FLASH SHALL NOT EXCEED 0.20mm ON ANY SIDE, IF PRESENT
 4. EXPOSED PAD SHALL BE SOLDER PLATED
 5. SHADED AREA IS ONLY A REFERENCE FOR PIN 1 LOCATION ON THE TOP AND BOTTOM OF PACKAGE
 6. DRAWING NOT TO SCALE

BOTTOM VIEW—EXPOSED PAD

PACKAGE DESCRIPTION

Please refer to <http://www.linear.com/product/LTC3875#packaging> for the most recent package drawings.

UJ Package
40-Lead Plastic QFN (6mm × 6mm)
 (Reference LTC DWG # 05-08-1728 Rev 0)

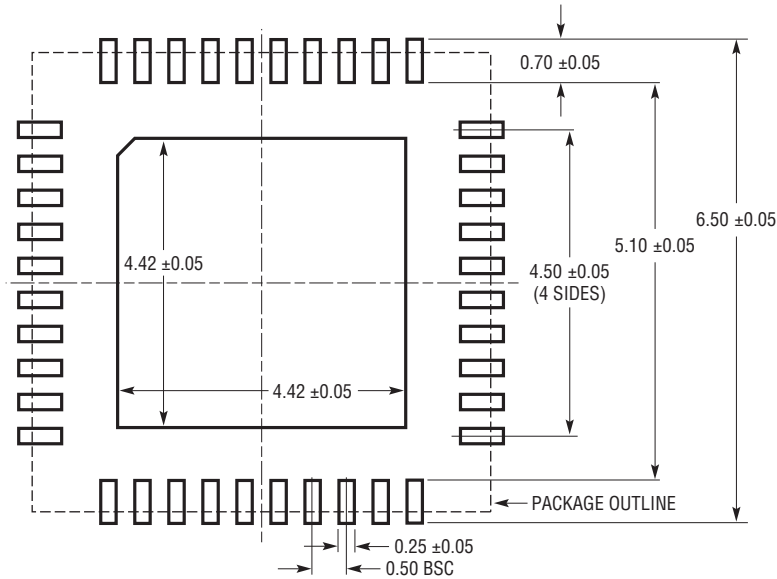

RECOMMENDED SOLDER PAD PITCH AND DIMENSIONS
 APPLY SOLDER MASK TO AREAS THAT ARE NOT SOLDERED

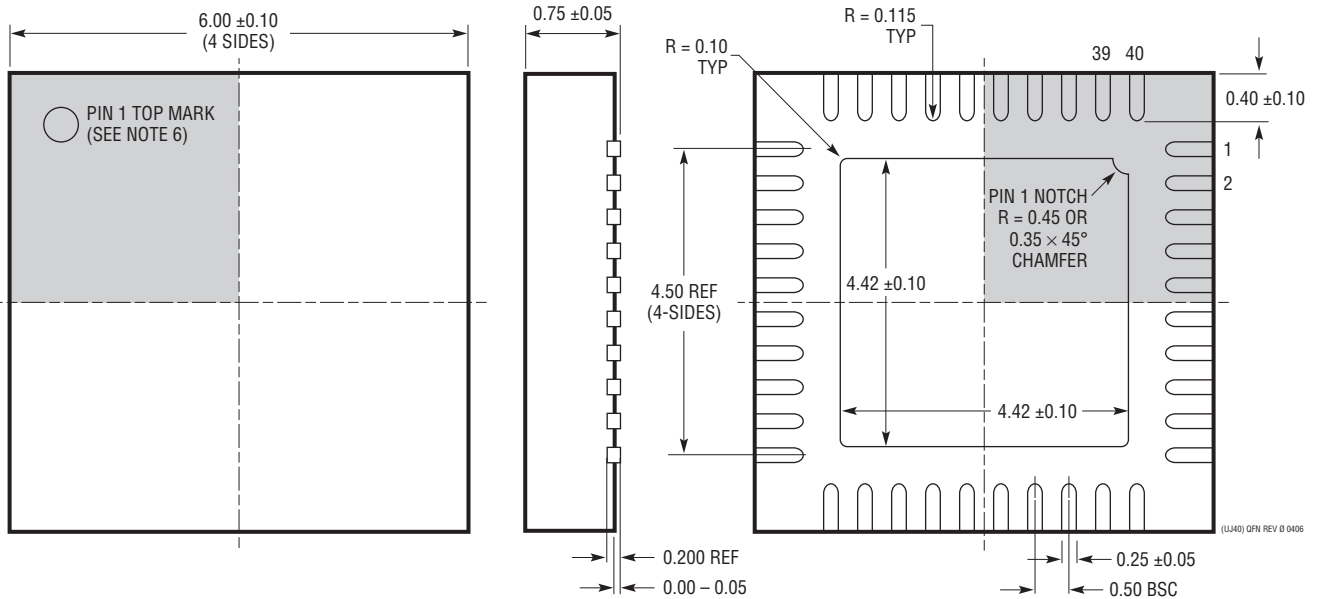

- NOTE:
1. DRAWING IS A JEDEC PACKAGE OUTLINE VARIATION OF (WJJD-2)
 2. DRAWING NOT TO SCALE
 3. ALL DIMENSIONS ARE IN MILLIMETERS
 4. DIMENSIONS OF EXPOSED PAD ON BOTTOM OF PACKAGE DO NOT INCLUDE MOLD FLASH. MOLD FLASH, IF PRESENT, SHALL NOT EXCEED 0.20mm ON ANY SIDE, IF PRESENT
 5. EXPOSED PAD SHALL BE SOLDER PLATED
 6. SHADED AREA IS ONLY A REFERENCE FOR PIN 1 LOCATION ON THE TOP AND BOTTOM OF PACKAGE

BOTTOM VIEW—EXPOSED PAD

REVISION HISTORY

REV	DATE	DESCRIPTION	PAGE NUMBER
A	4/15	Corrected typographical errors Modifications to figures Simplified schematics	1 to 30 28 to 35 36 to 44
B	11/15	Added UH Package Removed Temp Dot from I _{SENSE(AC)}	1, 2, 3, 5, 43 3

TYPICAL APPLICATION

High Efficiency Dual Phase 1V/60A Step-Down Converter

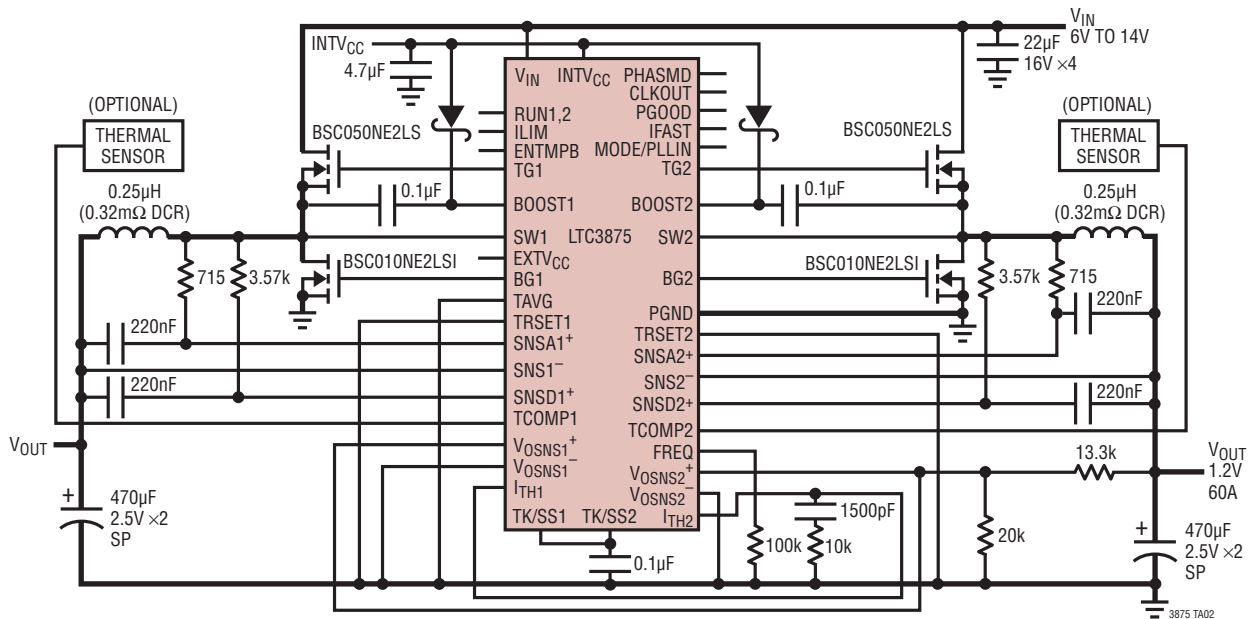

RELATED PARTS

PART NUMBER	DESCRIPTION	COMMENTS
LTC3774	Dual, Multiphase Current Mode Synchronous Step-Down DC/DC Controller for Sub-Milliohm DCR Sensing	Operates with DrMOS, Power Blocks or External Drives/MOSFETs, $4.5V \leq V_{IN} \leq 38V$, $0.6V \leq V_{OUT} \leq 3.5V$
LTC3866	Single Output Current Mode Synchronous Controller with Sub-Milliohm DCR Sensing	Synchronous Fixed Frequency 250kHz to 770kHz, $4.5V \leq V_{IN} \leq 38V$, $0.6V \leq V_{OUT} \leq 3.5V$
LTC3855	Dual, Multiphase, Synchronous Step-Down DC/DC Controller with Differential Output Sensing and DCR Temperature Compensation	PLL Fixed Frequency 250kHz to 770kHz, $4.5V \leq V_{IN} \leq 38V$, $0.8V \leq V_{OUT} \leq 12V$
LTC3838/LTC3838-1/LTC3838-2	Dual, Fast, Accurate Step-Down Controlled On-Time DC/DC Controller with Differential Output Sensing	Synchronizable Fixed Frequency 200kHz to 2MHz, $4.5V \leq V_{IN} \leq 38V$, $0.8V \leq V_{OUT} \leq 5.5V$
LTC3890/LTC3890-1/LTC3890-2/LTC3890-3	Dual, High V_{IN} , Low I_Q 2-Phase Synchronous Step-Down DC/DC Controller	PLL Capable Fixed Frequency 50kHz to 900kHz, $4V \leq V_{IN} \leq 60V$, $0.8V \leq V_{OUT} \leq 24V$, $I_Q = 50\mu A$
LTC3861/LTC3861-1	Dual, Multiphase, Synchronous Step-Down Voltage Mode DC/DC Controller with Diff Amp and Accurate Current Sharing	Operates with DrMOS, Power Blocks or External Drives/MOSFETs, $3V \leq V_{IN} \leq 24V$
LTC3856	Single Output, Dual Channel Synchronous Step-Down DC/DC Controller with Differential Output Sensing and DCR Temperature Compensation	Phase-Lockable Fixed 250kHz to 770kHz Frequency, $4.5V \leq V_{IN} \leq 38V$, $0.8V \leq V_{OUT} \leq 5V$
LTC3869	Dual 2-Phase, Synchronous Step-Down DC/DC Controller	Synchronous Fixed Frequency 250kHz to 780kHz, $4.5V \leq V_{IN} \leq 38V$, $0.6V \leq V_{OUT} \leq 12.5V$
LTC3857/LTC3857-1/LTC3858/LTC3858-1	38V Low I_Q , Dual Output 2-Phase Synchronous Step-Down DC/DC Controller with 99% Duty Cycle	PLL Fixed Operating Frequency 50kHz to 900kHz, $4V \leq V_{IN} \leq 38V$, $0.8V \leq V_{OUT} \leq 24V$, $I_Q = 50\mu A/170\mu A$

3875fb