

SMD Power Inductor

0415CDMCC/DS



Description

- Metal compound molding type construction
- Magnetically shielded
- Low audible core noise
- Suitable for large current.
- LxWxH:4.75x4.45x1.5mm Max.
- Product weight: 0.146g (Ref.)
- Moisture Sensitivity Level: 1



Environmental Data

- Operating temperature range: -55°C~+125°C (including coil's self temperature rise)
- Storage temperature range: -55°C~+125°C

Packaging

- Carrier tape and reel packaging.
- 3000pcs per reel.

Applications

- Ideally used in notebook, ultrabook, tablet PC, LCD display, server application.
- HDD,SSD modules application.
- Low profile, high current power supplies.
- Battery powered devices.
- High current, POL converters.
- DC/DC converter in distributed power systems.

Dimension - [mm]

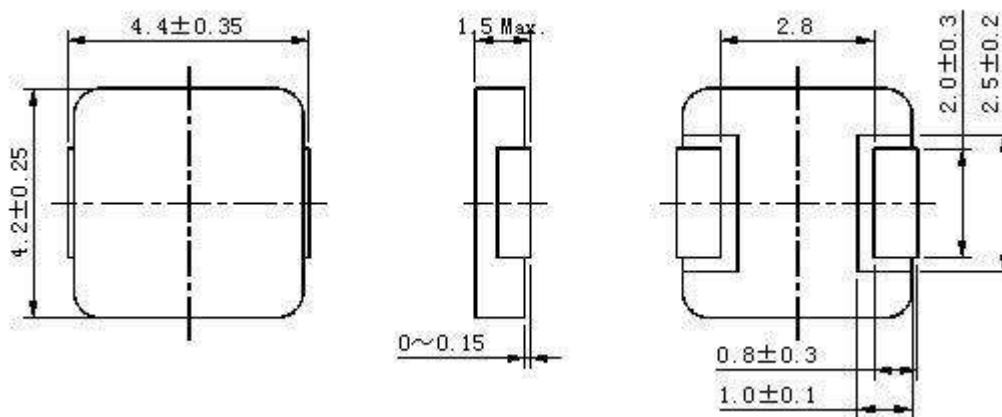

SMD Power Inductor

0415CDMCC/DS



Recommended Land pattern - [mm]

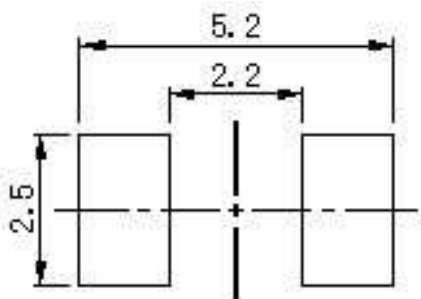

Wire Connection

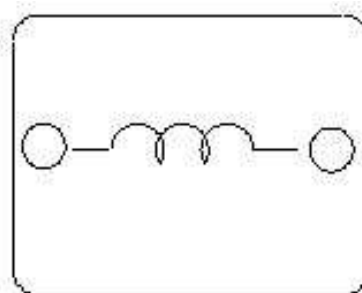

SMD Power Inductor

0415CDMCC/DS



Electrical Characteristics

Part Number	Inductance [Within] (μ H) ※1	D.C.R. at 20°C max(typ) (m Ω)	Saturation Current at 20°C(A) ※2	Temperature Rise Current (A) ※3
0415CDMCCDS-R22MC	0.22 \pm 20%	7.20 (6.00)	14.00	12.00
0415CDMCCDS-R33MC	0.33 \pm 20%	8.40 (7.00)	11.00	11.60
0415CDMCCDS-R47MC	0.47 \pm 20%	13.20 (11.00)	10.00	8.40
0415CDMCCDS-R56MC	0.56 \pm 20%	14.40 (12.00)	8.70	8.70
0415CDMCCDS-R68MC	0.68 \pm 20%	19.20 (16.00)	8.60	7.30
0415CDMCCDS-1R0MC	1.00 \pm 20%	27.60 (23.00)	8.00	5.60
0415CDMCCDS-1R5MC	1.50 \pm 20%	42.00 (35.00)	6.00	4.70
0415CDMCCDS-2R2MC	2.20 \pm 20%	78.00 (65.00)	5.50	3.30
0415CDMCCDS-3R3MC	3.30 \pm 20%	92.40 (77.00)	4.00	3.20
0415CDMCCDS-4R7MC	4.70 \pm 20%	130 (108)	3.00	2.60
0415CDMCCDS-6R8MC	6.80 \pm 20%	206.40 (172)	2.50	2.10

※1 Measuring frequency Inductance at 100kHz 1V.

※2 Saturation current: This indicates the actual value of D.C. current when the inductance becomes 30% lower than its initial value.

※3 Temperature rise current: The actual value of D.C. current when the temperature of coil becomes $\Delta T=40^{\circ}\text{C}$ ($T_a=25^{\circ}\text{C}$). (Test board condition: FR4, Copper=70 μ m, four-layer PWB t=1.6mm)

Solder Reflow Condition

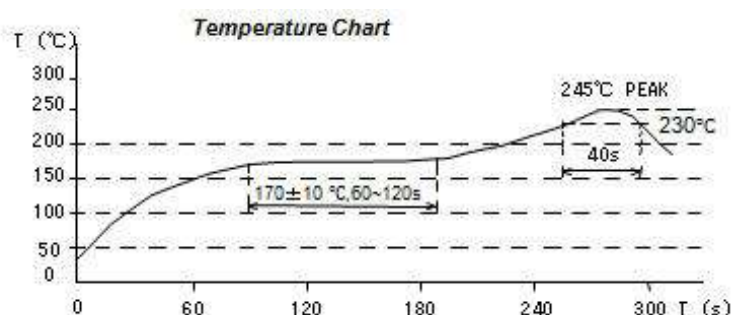
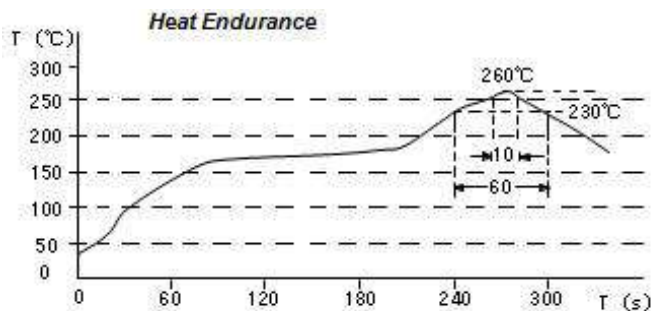

SMD Power Inductor

0415CDMCC/DS



Saturation Current & Temperature Rise Graph

— L (20°C) — ΔT

1. 0415CDMCCDS-R22MC

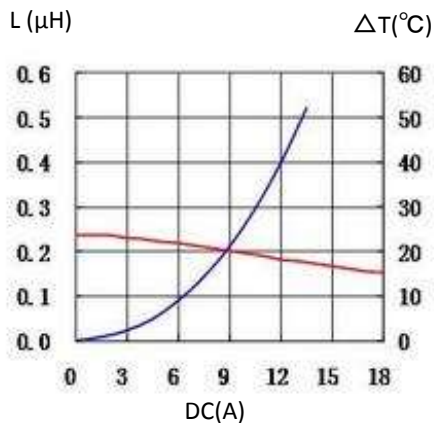

2. 0415CDMCCDS-R33MC

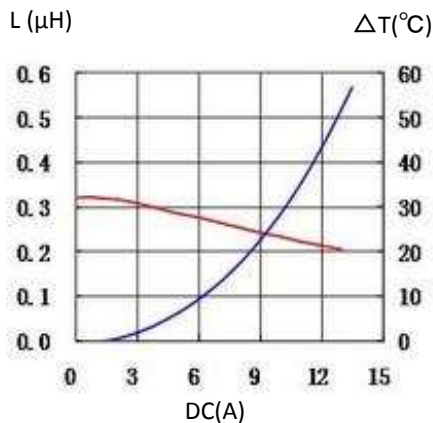

3. 0415CDMCCDS-R47MC

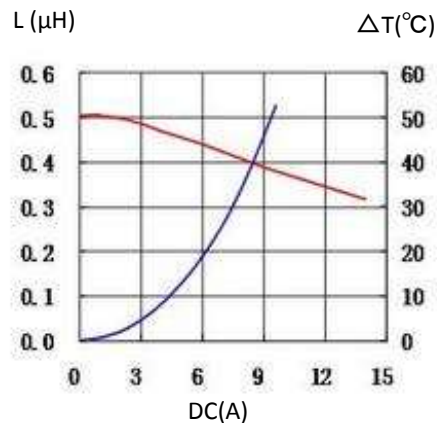

4. 0415CDMCCDS-R56MC

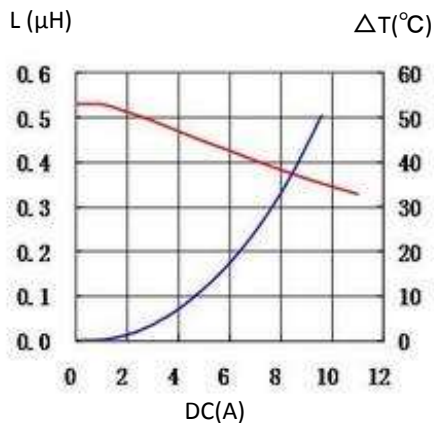

5. 0415CDMCCDS-R68MC

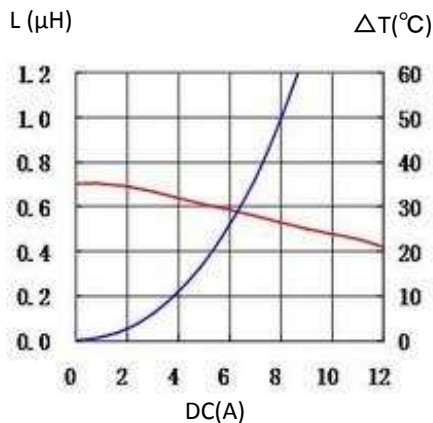

6. 0415CDMCCDS-1R0MC

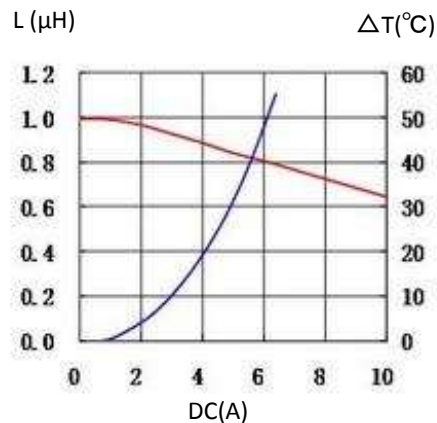

7. 0415CDMCCDS-1R5MC

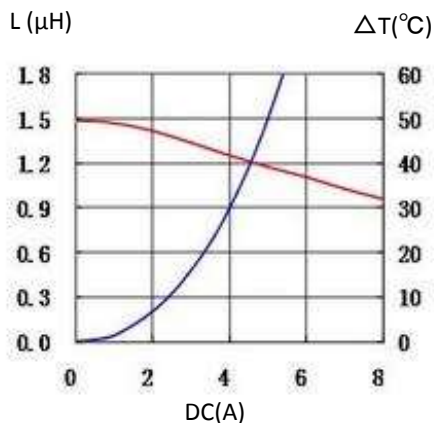

8. 0415CDMCCDS-2R2MC

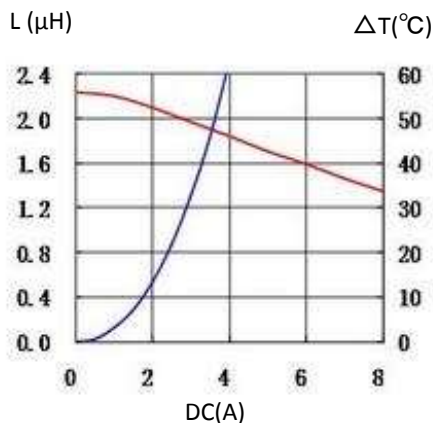

9. 0415CDMCCDS-3R3MC

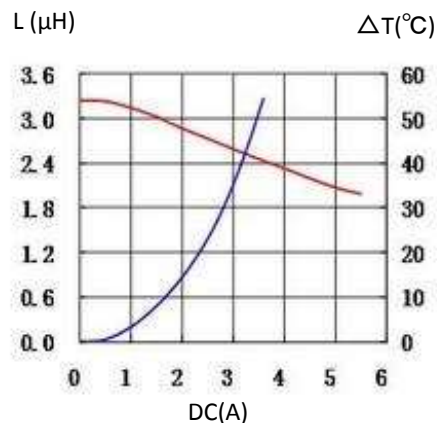

Note: This specification is subject to change without notice. Please contact your nearest sales office for updated information when placing an order.

SMD Power Inductor

0415CDMCC/DS



10. 0415CDMCCDS-4R7MC

11. 0415CDMCCDS-6R8MC

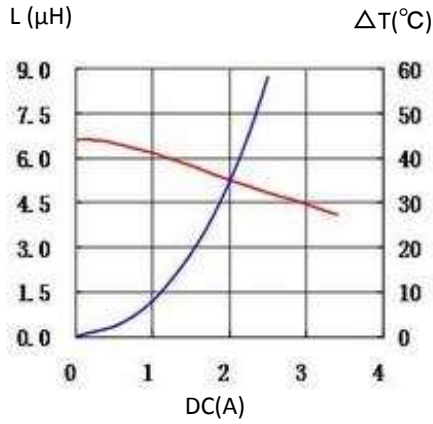
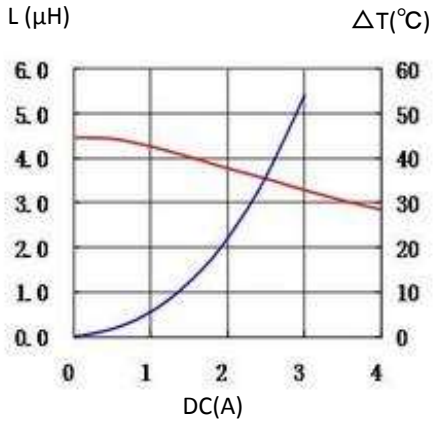

For sales office information, please [click here](#) to visit our website.