

## 24-Bit, 192 kHz 6 Channel D/A Converter

### Features

- 24-Bit Conversion
- 102 dB Dynamic Range
- -90 dB THD+N
- +3 V to +5 V Power Supply
- Digital Volume Control with Soft Ramp
  - 119 dB Attenuation
  - 1 dB Step Size
  - Zero Crossing Click-Free Transitions
- Low Power Consumption
  - 105 mW with 3 V supply
- ATAPI Mixing
- Low Clock Jitter Sensitivity
- Popguard Technology<sup>®</sup> for Control of Clicks and Pops

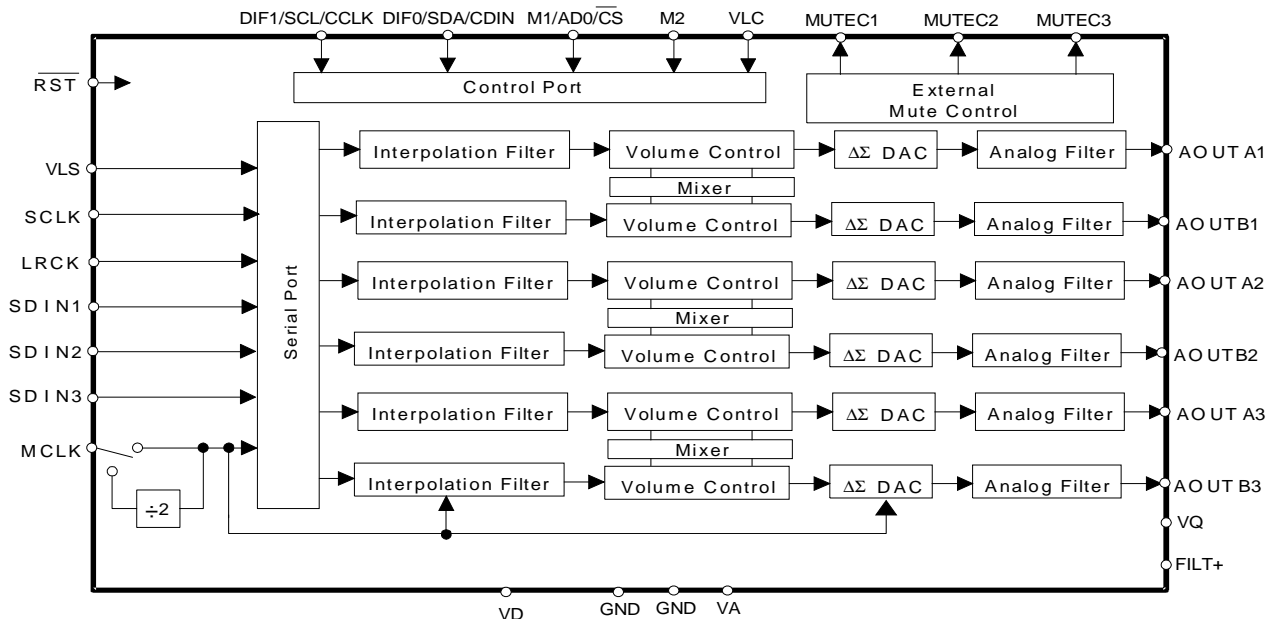
### Description

The CS4360 is a complete 6-channel digital-to-analog system including digital interpolation, fourth-order delta-sigma digital-to-analog conversion, digital de-emphasis, volume control, channel mixing and analog filtering. The advantages of this architecture include: ideal differential linearity, no distortion mechanisms due to resistor matching errors, no linearity drift over time and temperature and a high tolerance to clock jitter.

The CS4360 accepts data at audio sample rates from 4 kHz to 200 kHz, consumes very little power and operates over a wide power supply range. These features are ideal for cost-sensitive, multi-channel audio systems including DVD players, A/V receivers, set-top boxes, digital TVs and VCRs, mini-component systems, and mixing consoles.

### ORDERING INFORMATION

|           |              |                  |
|-----------|--------------|------------------|
| CS4360-KS | -10 to 70 °C | 28-pin SOIC      |
| CS4360-BS | -40 to 85 °C | 28-pin SOIC      |
| CS4360-KZ | -10 to 70 °C | 28-pin TSSOP     |
| CS4360-BZ | -40 to 85 °C | 28-pin TSSOP     |
| CDB4360   |              | Evaluation Board |



**Preliminary Product Information**

This document contains information for a new product. Cirrus Logic reserves the right to modify this product without notice.

---

## TABLE OF CONTENTS

|   |           |
|---|-----------|
| <b>1. CHARACTERISTICS AND SPECIFICATIONS .....</b>  | <b>5</b>  |
| ANALOG CHARACTERISTICS .....  | 5         |
| POWER AND THERMAL CHARACTERISTICS .....   | 7         |
| DIGITAL CHARACTERISTICS .....   | 7         |
| ABSOLUTE MAXIMUM RATINGS .....  | 7         |
| RECOMMENDED OPERATING CONDITIONS .....  | 8         |
| SWITCHING CHARACTERISTICS .....   | 9         |
| SWITCHING CHARACTERISTICS- CONTROL PORT- TWO-WIRE FORMAT .....  | 10        |
| SWITCHING CHARACTERISTICS - CONTROL PORT - SPI FORMAT .....   | 11        |
| <b>2. TYPICAL CONNECTION DIAGRAM.....</b>   | <b>12</b> |
| <b>3. REGISTER QUICK REFERENCE .....</b>  | <b>13</b> |
| <b>4. REGISTER DESCRIPTIONS .....</b>   | <b>14</b> |
| 4.1 Mode Control 1 (address 01h) .....  | 14        |
| 4.1.1 Auto-mute (AMUTE) .....   | 14        |
| 4.1.2 Digital Interface Format (DIF) .....  | 14        |
| 4.1.3 De-Emphasis Control (DEM) .....   | 15        |
| 4.1.4 Functional Mode (FM).....   | 15        |
| 4.2 Invert Signal (address 02h).....  | 15        |
| 4.2.1 Invert Signal Polarity (INV_xx).....  | 15        |
| 4.3 Mixing Control Pair 1 (Channels A1 & B1) (address 03h)<br>Mixing Control Pair 2 (Channels A2 & B2) (address 04h)<br>Mixing Control Pair 3 (Channels A3 & B3) (address 05h)..... | 15        |
| 4.3.1 ATAPI Channel Mixing and Muting (ATAPI) .....   | 16        |
| 4.4 Volume Control (addresses 06h - 0Bh).....   | 16        |
| 4.4.1 Mute (MUTE) .....   | 16        |
| 4.4.2 Volume Control (xx_VOL).....  | 17        |
| 4.5 Mode Control 2 (address 0Dh).....   | 17        |
| 4.5.1 Soft Ramp and Zero Cross Control (SZC) .....  | 17        |
| 4.5.2 Control Port Enable (CPEN) .....  | 18        |
| 4.5.3 Power Down (PDN).....   | 18        |
| 4.5.4 Popguard® Transient Control (POPG) .....  | 18        |
| 4.5.5 Freeze Controls (FREEZE).....   | 18        |
| 4.5.6 Master Clock Divide Enable (MCLKDIV) .....  | 18        |
| 4.5.7 Single Volume Control (SINGLVOL).....   | 19        |
| 4.6 Revision Register (Read Only) (address 0Dh).....  | 19        |

---

### Contacting Cirrus Logic Support

For a complete listing of Direct Sales, Distributor, and Sales Representative contacts, visit the Cirrus Logic web site at:  
<http://www.cirrus.com/corporate/contacts/sales.cfm>

---

Preliminary product information describes products which are in production, but for which full characterization data is not yet available. Advance product information describes products which are in development and subject to development changes. Cirrus Logic, Inc. has made best efforts to ensure that the information contained in this document is accurate and reliable. However, the information is subject to change without notice and is provided "AS IS" without warranty of any kind (express or implied). Customers are advised to obtain the latest version of relevant information to verify, before placing orders, that information being relied on is current and complete. All products are sold subject to the terms and conditions of sale supplied at the time of order acknowledgment, including those pertaining to warranty, patent infringement, and limitation of liability. No responsibility is assumed by Cirrus Logic, Inc. for the use of this information, including use of this information as the basis for manufacture or sale of any items, nor for infringements of patents or other rights of third parties. This document is the property of Cirrus Logic, Inc. and by furnishing this information, Cirrus Logic, Inc. grants no license, express or implied under any patents, mask work rights, copyrights, trademarks, trade secrets or other intellectual property rights of Cirrus Logic, Inc. Cirrus Logic, Inc., copyright owner of the information contained herein, gives consent for copies to be made of the information only for use within your organization with respect to Cirrus Logic integrated circuits or other parts of Cirrus Logic, Inc. The same consent is given for similar information contained on any Cirrus Logic website or disk. This consent does not extend to other copying such as copying for general distribution, advertising or promotional purposes, or for creating any work for resale. The names of products of Cirrus Logic, Inc. or other vendors and suppliers appearing in this document may be trademarks or service marks of their respective owners which may be registered in some jurisdictions. A list of Cirrus Logic, Inc. trademarks and service marks can be found at <http://www.cirrus.com>.

|  |           |
|--|-----------|
| 4.6.1 Revision Indicator (REV) [Read Only] ..... | 19        |
| <b>5. PIN DESCRIPTION.....</b>                   | <b>20</b> |
| <b>6. APPLICATIONS .....</b>                     | <b>23</b> |
| 6.1 Grounding and Power Supply Decoupling.....   | 23        |
| 6.2 Oversampling Modes.....                      | 23        |
| 6.3 Recommended Power-up Sequence.....           | 23        |
| 6.4 Popguard® Transient Control.....             | 23        |
| <b>7. CONTROL PORT INTERFACE.....</b>            | <b>24</b> |
| 7.1 Enabling the Control Port .....              | 24        |
| 7.2 Format Selection .....                       | 24        |
| 7.3 Two-Wire Format.....                         | 24        |
| 7.3.1 Writing in Two-Wire Format .....           | 24        |
| 7.3.2 Reading in Two-Wire Format.....            | 25        |
| 7.4 SPI Format .....                             | 25        |
| 7.4.1 Writing in SPI.....                        | 25        |
| 7.5 Memory Address Pointer (MAP).....            | 26        |
| 7.5.1 INCR (Auto Map Increment Enable).....      | 26        |
| 7.5.2 MAP (Memory Address Pointer).....          | 26        |
| <b>8. PARAMETER DEFINITIONS.....</b>             | <b>32</b> |
| Total Harmonic Distortion + Noise (THD+N) .....  | 32        |
| Dynamic Range .....                              | 32        |
| Interchannel Isolation .....                     | 32        |
| Interchannel Gain Mismatch.....                  | 32        |
| Gain Error .....                                 | 32        |
| Gain Drift .....                                 | 32        |
| <b>9. REFERENCES.....</b>                        | <b>32</b> |
| <b>10. PACKAGE DIMENSIONS .....</b>              | <b>33</b> |

## LIST OF FIGURES

|  |    |
|--|----|
| Figure 1. Serial Mode Input Timing .....                             | 9  |
| Figure 2. Control Port Timing - Two-Wire Format .....                | 10 |
| Figure 3. Control Port Timing - SPI Format .....                     | 11 |
| Figure 4. Typical Connection Diagram .....                           | 12 |
| Figure 5. Control Port Timing, Two-Wire Format .....                 | 25 |
| Figure 6. Control Port Timing, SPI Format .....                      | 25 |
| Figure 7. Base-Rate Stopband Rejection .....                         | 27 |
| Figure 8. Base-Rate Transition Band .....                            | 27 |
| Figure 9. Base-Rate Transition Band (Detail) .....                   | 27 |
| Figure 10. Base-Rate Passband Ripple .....                           | 27 |
| Figure 11. High-Rate Stopband Rejection .....                        | 27 |
| Figure 12. High-Rate Transition Band .....                           | 27 |
| Figure 13. High-Rate Transition Band (Detail) .....                  | 28 |
| Figure 14. High-Rate Passband Ripple .....                           | 28 |
| Figure 15. Output Test Load .....                                    | 28 |
| Figure 16. Maximum Loading .....                                     | 28 |
| Figure 17. CS4360 Format 0 - Left Justified upto 24-bit Data .....   | 29 |
| Figure 18. CS4360 Format 1 - I <sup>2</sup> S upto 24-bit Data ..... | 29 |
| Figure 19. CS4360 Format 2 - Right Justified 16-bit Data .....       | 29 |
| Figure 20. CS4360 Format 3 - Right Justified 24-bit Data .....       | 29 |
| Figure 21. CS4360 Format 4 - Right Justified 20-bit Data .....       | 30 |

---

|  |    |
|--|----|
| Figure 22. CS4360 Format 5 - Right Justified 18-bit Data ..... | 30 |
| Figure 23. De-Emphasis Curve .....                             | 30 |
| Figure 24. ATAPI Block Diagram .....                           | 31 |

**LIST OF TABLES**

|  |    |
|--|----|
| Table 1. Digital Interface Formats - Control Port Mode ..... | 14 |
| Table 2. ATAPI Decode .....                                  | 16 |
| Table 3. Example Digital Volume Settings .....               | 17 |
| Table 4. Digital Interface Formats - Stand Alone Mode .....  | 21 |
| Table 5. Mode Selection .....                                | 21 |
| Table 6. Single-Speed Mode Common Clock Frequencies .....    | 22 |
| Table 7. Double-Speed Mode Common Clock Frequencies .....    | 22 |
| Table 8. Quad-Speed Mode Common Clock Frequencies .....      | 22 |

## 1. CHARACTERISTICS AND SPECIFICATIONS

### ANALOG CHARACTERISTICS

(Full-Scale Output Sine Wave, 997 Hz; for Single-Speed Mode,  $F_s = 48$  kHz, SCLK = 3.072 MHz, MCLK = 12.288 MHz; for Double-Speed Mode  $F_s = 96$  kHz, SCLK = 6.144 MHz, MCLK = 12.288 MHz; for Quad-Speed Mode  $F_s = 192$  kHz, SCLK = 12.288 MHz, MCLK = 24.576 MHz; Measurement Bandwidth 10 Hz to 20 kHz, unless otherwise specified. Test load  $R_L = 10$  k $\Omega$ ,  $C_L = 10$  pF (see Figure 15).  $V_A = V_D = V_{LS} = V_{LC}$ ),

| Parameter   | Symbol     | VA = 5 V |     |     | VA = 3 V |     |     | Unit |
|---|------------|----------|-----|-----|----------|-----|-----|------|
|   |            | Min      | Typ | Max | Min      | Typ | Max |      |
| <b>CS4360-KS/-KZ Dynamic Performance (Note 1)</b> |            |          |     |     |          |     |     |      |
| Specified Temperature Range                       | $T_A$      | -10      | -   | 70  | -10      | -   | 70  | °C   |
| Dynamic Range (Note 2)                            | unweighted | TBD      | 99  | -   | TBD      | 94  | -   | dB   |
|   | A-Weighted | TBD      | 102 | -   | TBD      | 97  | -   | dB   |
| 40 kHz Bandwidth                                  | A-Weighted | -        | 100 | -   | -        | 97  | -   | dB   |
| Total Harmonic Distortion + Noise (Note 2)        | THD+N      | -        | -   | -   | -        | -   | -   | -    |
|   | 0 dB       | -        | -91 | TBD | -        | -91 | TBD | dB   |
|   | -20 dB     | -        | -79 | -   | -        | -74 | -   | dB   |
|   | -60 dB     | -        | -39 | -   | -        | -34 | -   | dB   |
| Interchannel Isolation (1 kHz)                    |            | -        | 102 | -   | -        | 102 | -   | dB   |
| <b>CS4360-BS/-BZ Dynamic Performance (Note 3)</b> |            |          |     |     |          |     |     |      |
| Specified Temperature Range                       | $T_A$      | -40      | -   | 85  | -40      | -   | 85  | °C   |
| Dynamic Range (Note 2)                            | unweighted | TBD      | 99  | -   | TBD      | 94  | -   | dB   |
|   | A-Weighted | TBD      | 102 | -   | TBD      | 97  | -   | dB   |
| 40 kHz Bandwidth                                  | A-Weighted | -        | 100 | -   | -        | 97  | -   | dB   |
| Total Harmonic Distortion + Noise (Note 2)        | THD+N      | -        | -   | -   | -        | -   | -   | -    |
|   | 0 dB       | -        | -91 | TBD | -        | -91 | TBD | dB   |
|   | -20 dB     | -        | -79 | -   | -        | -74 | -   | dB   |
|   | -60 dB     | -        | -39 | -   | -        | -34 | -   | dB   |
| Interchannel Isolation (1 kHz)                    |            | -        | 102 | -   | -        | 102 | -   | dB   |

- Notes:
- CS4360-KS/-KZ parts are tested at 25 °C.
  - One-half LSB of triangular PDF dither is added to data.
  - CS4360-BS/-BZ parts are tested at the extremes of the specified temperature range and Min/Max performance numbers are guaranteed across the specified temperature range,  $T_A$ . Typical numbers are taken at 25 °C.

### ANALOG CHARACTERISTICS (Continued)

| Parameter   | Symbol                             | Min   | Typ | Max   | Unit |
|---|------------------------------------|-------|-----|-------|------|
| <b>Combined Digital and On-chip Analog Filter Response - Single-Speed Mode (Note 4)</b> |                                    |       |     |       |      |
| Passband (Note 5)   |                                    | 0     | -   | .4535 | Fs   |
|   | to -0.05 dB corner to -3 dB corner | 0     | -   | .4998 | Fs   |
| Frequency Response 10 Hz to 20 kHz  |                                    | -.02  | -   | +.035 | dB   |
| StopBand  |                                    | .5465 | -   | -     | Fs   |

| Parameter   | Symbol          | Min | Typ                  | Max         | Unit |
|---|-----------------|-----|----------------------|-------------|------|
| StopBand Attenuation (Note 6)                     |                 | 50  | -                    | -           | dB   |
| Group Delay                                       | tg <sub>d</sub> | -   | 9/F <sub>s</sub>     | -           | s    |
| Passband Group Delay Deviation 0 - 20 kHz         |                 | -   | ±0.36/F <sub>s</sub> | -           | s    |
| De-emphasis Error (Relative to 1 kHz) Fs = 32 kHz |                 | -   | -                    | +2/-1       | dB   |
| Control Port Mode (Note 7) Fs = 44.1 kHz          |                 | -   | -                    | +0.05/-1.14 | dB   |
| Fs = 48 kHz                                       |                 | -   | -                    | +0/-0.22    | dB   |
| Stand-Alone Mode Fs = 32 kHz                      |                 | -   | -                    | +1.5/-0     | dB   |
| Fs = 44.1 kHz                                     |                 | -   | -                    | +0.05/-1.14 | dB   |
| Fs = 48 kHz                                       |                 | -   | -                    | +2/-0.4     | dB   |

**Combined Digital and On-chip Analog Filter Response - Double-Speed Mode (Note 4)**

|   |                 |      |                      |       |                |
|---|-----------------|------|----------------------|-------|----------------|
| Passband (Note 5)                         |                 | 0    | -                    | .4621 | F <sub>s</sub> |
| to -0.1 dB corner                         |                 | 0    | -                    | .4982 | F <sub>s</sub> |
| to -3 dB corner                           |                 |      |                      |       |                |
| Frequency Response 10 Hz to 20 kHz        |                 | -0.1 | -                    | 0     | dB             |
| StopBand                                  |                 | .577 | -                    | -     | F <sub>s</sub> |
| StopBand Attenuation (Note 6)             |                 | 55   | -                    | -     | dB             |
| Group Delay                               | tg <sub>d</sub> | -    | 4/F <sub>s</sub>     | -     | s              |
| Passband Group Delay Deviation 0 - 20 kHz |                 | -    | ±0.23/F <sub>s</sub> | -     | s              |

**Combined Digital and On-chip Analog Filter Response - Quad-Speed Mode (Note 4)**

|                                    |                 |      |                    |     |                |
|------------------------------------|-----------------|------|--------------------|-----|----------------|
| Passband (Note 5)                  |                 | 0    | -                  | .25 | F <sub>s</sub> |
| to -3 dB corner                    |                 |      |                    |     |                |
| Frequency Response 10 Hz to 20 kHz |                 | -0.7 | -                  | 0   | dB             |
| Group Delay                        | tg <sub>d</sub> | -    | 1.5/F <sub>s</sub> | -   | s              |

| Parameters                  | Symbol           | Min                 | Typ                 | Max                 | Units           |
|-----------------------------|------------------|---------------------|---------------------|---------------------|-----------------|
| <b>Analog Output</b>        |                  |                     |                     |                     |                 |
| Full Scale Output Voltage   |                  | 0.60•V <sub>A</sub> | 0.66•V <sub>A</sub> | 0.72•V <sub>A</sub> | V <sub>pp</sub> |
| Quiescent Voltage           | V <sub>Q</sub>   | -                   | 0.5•V <sub>A</sub>  | -                   | VDC             |
| Quiescent Pin External Load | I <sub>Q</sub>   | -                   | -                   | TBD                 | VDC             |
| Interchannel Gain Mismatch  |                  | -                   | 0.1                 | -                   | dB              |
| Gain Drift                  |                  | -                   | 100                 | -                   | ppm/°C          |
| AC-Load Resistance (Note 8) | R <sub>L</sub>   | 3                   | -                   | -                   | kΩ              |
| Load Capacitance            | C <sub>L</sub>   | -                   | -                   | 100                 | pF              |
| Output Impedance            | Z <sub>OUT</sub> | -                   | 100                 | -                   | Ω               |

Notes: 4. Filter response is guaranteed by design.

5. Response is clock dependent and will scale with F<sub>s</sub>. Note that the response plots (Figures 9 - 12) have been normalized to F<sub>s</sub> and can be de-normalized by multiplying the X-axis scale by F<sub>s</sub>.

6. For Single-Speed Mode, the Measurement Bandwidth is .5465 F<sub>s</sub> to 3 F<sub>s</sub>.  
For Double-Speed Mode, the Measurement Bandwidth is .577 F<sub>s</sub> to 1.4 F<sub>s</sub>.

7. De-emphasis is available only in Single-Speed Mode.

8. Refer to Figure 16.

**POWER AND THERMAL CHARACTERISTICS**

| Parameters                                | Symbol                               | Min           | Typ   | Max   | Units |         |
|---|--------------------------------------|---------------|-------|-------|-------|---------|
| <b>Power Supplies</b>                     |                                      |               |       |       |       |         |
| Power Supply Current (Note 9)             | normal operation, All Supplies = 5 V | $I_A$         | -     | 22    | -     | mA      |
|   |                                      | $I_D$         | -     | 25    | -     | mA      |
|   | All Supplies = 3 V                   | $I_A$         | -     | 21    | -     | mA      |
|   |                                      | $I_D$         | -     | 14    | -     | mA      |
|   | Interface current (Note 10)          | $I_{LS}$      | -     | 0.002 | -     | mA      |
|   |                                      | $I_{LC}$      | -     | 0.002 | -     | mA      |
| power-down state (all supplies) (Note 11) | $I_{pd}$                             | -             | 0.016 | -     | mA    |         |
| Power Dissipation (Note 9)                |                                      |               |       |       |       |         |
| All Supplies = 5 V                        | normal operation                     | -             | 235   | TBD   | mW    |         |
|   | power-down (Note 11)                 | -             | 0.080 | -     | mW    |         |
| All Supplies = 3 V                        | normal operation                     | -             | 105   | TBD   | mW    |         |
|   | power-down (Note 11)                 | -             | 0.048 | -     | mW    |         |
| Package Thermal Resistance                | SOIC (-KS & -BS)                     | $\theta_{JA}$ | -     | TBD   | -     | °C/Watt |
|   |                                      | $\theta_{JC}$ | -     | TBD   | -     | °C/Watt |
|   | TSSOP (-KZ & -BZ)                    | $\theta_{JA}$ | -     | TBD   | -     | °C/Watt |
|   |                                      | $\theta_{JC}$ | -     | TBD   | -     | °C/Watt |
| Power Supply Rejection Ratio (1 kHz)      | (Note 12)                            | PSRR          | -     | 60    | -     | dB      |
|   | (60 Hz)                              | PSRR          | -     | 40    | -     | dB      |

Notes: 9. Current consumption is directly proportional to Fs. Typ and Max values are based on highest FS

10.  $I_{LC}$  measured with no external loading on pin 12 (SDA).

11. Power down mode is defined as  $\overline{RST}$  = Low with all clock and data lines held static.

12. Valid with the recommended capacitor values on FILT+ and  $V_{CM}$  as shown in Figure 4.

**DIGITAL CHARACTERISTICS** (For -KS & -KZ parts  $T_A = -10$  to  $+70^\circ\text{C}$ ; for -BS & -BZ parts  $T_A = -40$  to  $+85^\circ\text{C}$ ;  $V_D = 2.0\text{ V} - 5.5\text{ V}$ ,  $V_{LC} = V_{LS} = 1.8\text{ V} - 5.5\text{ V}$ )

| Parameters                       | Symbol                 | Min      | Typ | Max      | Units         |
|----------------------------------|------------------------|----------|-----|----------|---------------|
| High-Level Input Voltage         | Serial Audio Data Port | $V_{IH}$ | 70% | -        | VLS           |
|                                  | Control Port           | $V_{IH}$ | 70% | -        | VLC           |
| Low-Level Input Voltage          | Serial Audio Data Port | $V_{IL}$ | -   | -        | 20% VLS       |
|                                  | Control Port           | $V_{IL}$ | -   | -        | 20% VLC       |
| Input Leakage Current            | $I_{in}$               | -        | -   | $\pm 10$ | $\mu\text{A}$ |
| Input Capacitance                |                        | -        | 8   | -        | pF            |
| Maximum MUTE C Drive Current     |                        | -        | 3   | -        | mA            |
| MUTE C High-Level Output Voltage | $V_{OH}$               |          | VA  |          | V             |
| MUTE C Low-Level Output Voltage  | $V_{OL}$               |          | 0   |          | V             |

**ABSOLUTE MAXIMUM RATINGS** (GND = 0V; all voltages with respect to ground.)

| Parameters                                    | Symbol                            | Min          | Max  | Units     |   |
|---|-----------------------------------|--------------|------|-----------|---|
| DC Power Supply                               | Analog power                      | VA           | -0.3 | 6.0       | V |
|   | Digital power                     | VD           | -0.3 | 6.0       | V |
|   | Serial Audio Data Interface power | VLS          | -0.3 | 6.0       | V |
|   | Control Port Interface power      | VLC          | -0.3 | 6.0       | V |
| Input Current, Any Pin Except Supplies        | $I_{in}$                          | -            | ±10  | mA        |   |
| Digital Input Voltage                         | Serial audio data interface       | $V_{IND\_S}$ | -0.3 | VLS + 0.4 | V |
|   | Control port interface            | $V_{IND\_C}$ | -0.3 | VLC + 0.4 | V |
| Ambient Operating Temperature (power applied) | $T_A$                             | -55          | 125  | °C        |   |
| Storage Temperature                           | $T_{stg}$                         | -65          | 150  | °C        |   |

WARNING: Operation at or beyond these limits may result in permanent damage to the device. Normal operation is not guaranteed at these extremes.

**RECOMMENDED OPERATING CONDITIONS** (GND = 0V; all voltages with respect to ground.)

| Parameters      | Symbol                                      | Min | Typ | Max | Units |   |
|-----------------|---|-----|-----|-----|-------|---|
| DC Power Supply | Analog Power                                | VA  | 2.7 | 5   | 5.5   | V |
|                 | Digital Power                               | VD  | 2.0 | 5   | VA    | V |
|                 | Serial Audio Data Interface Power (Note 13) | VLS | 1.8 | 5   | 5.5   | V |
|                 | Control Port Interface Power (Note 14)      | VLC | 1.8 | 5   | 5.5   | V |

13. Applies to pins 2, 3, 4, 5, 6, and 7.

14. Applies to pins 10, 11, 12, and 13.



**SWITCHING CHARACTERISTICS** (For -KS & -KZ parts  $T_A = -10$  to  $+70^\circ\text{C}$ ; for -BS & -BZ parts  $T_A = -40$  to  $+85^\circ\text{C}$ ; VLS = 1.7 V to 5.5 V; Inputs: Logic 0 = 0 V, Logic 1 = VLS CL = 20 pF)

| Parameters                            | Symbol            | Min   | Typ | Max    | Units |     |
|---------------------------------------|-------------------|-------|-----|--------|-------|-----|
| Input Sample Rate                     | Single-Speed Mode | $F_s$ | 4   | -      | 50    | kHz |
|                                       | Double-Speed Mode | $F_s$ | 50  | -      | 100   | kHz |
|                                       | Quad-Speed Mode   | $F_s$ | 100 | -      | 200   | kHz |
| LRCK Duty Cycle                       |                   | 45    | 50  | 55     | %     |     |
| MCLK Duty Cycle                       |                   | 40    | 50  | 60     | %     |     |
| SCLK Frequency                        |                   | -     | -   | MCLK/2 | Hz    |     |
| SCLK Frequency                        | Note 15           | -     | -   | MCLK/4 | Hz    |     |
| SCLK rising to LRCK edge delay        | $t_{slrd}$        | 20    | -   | -      | ns    |     |
| SCLK rising to LRCK edge setup time   | $t_{slrs}$        | 20    | -   | -      | ns    |     |
| SDATA valid to SCLK rising setup time | $t_{sdhrs}$       | 20    | -   | -      | ns    |     |
| SCLK rising to SDATA hold time        | $t_{sdh}$         | 20    | -   | -      | ns    |     |

Notes: 15. This serial clock is available only in Control Port Mode when the MCLK Divide bit is enabled.

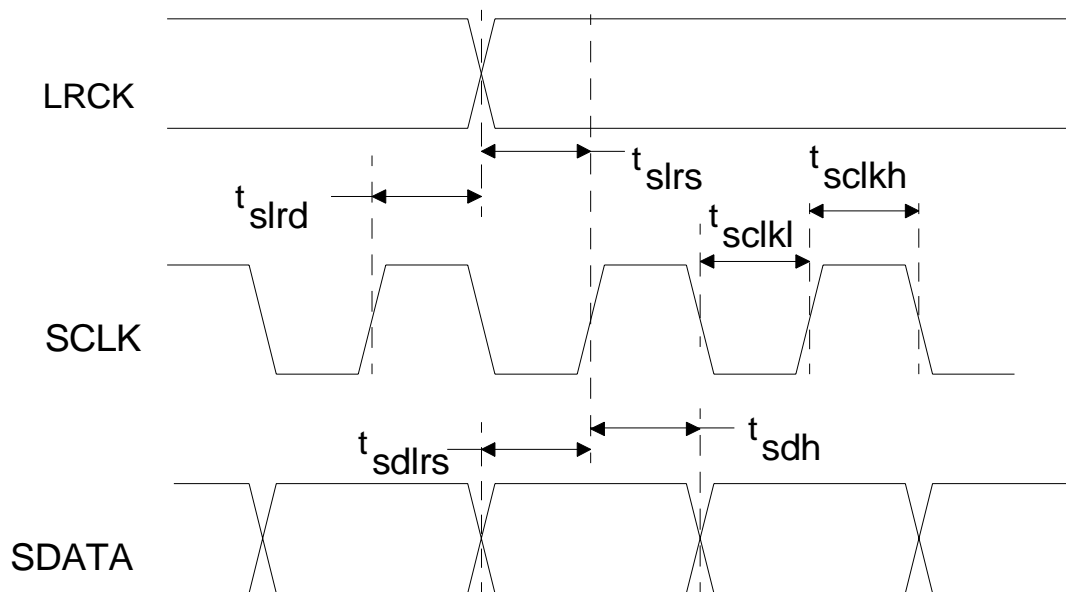


Figure 1. Serial Mode Input Timing

## SWITCHING CHARACTERISTICS- CONTROL PORT- TWO-WIRE FORMAT

(Note 16) (For -KS & -KZ parts  $T_A = -10$  to  $+70^\circ\text{C}$ ; for -BS & -BZ parts  $T_A = -40$  to  $+85^\circ\text{C}$ ; VLC = 1.7 V - 5.5 V; Inputs: Logic 0 = GND, Logic 1 = VLC,  $C_L = 30$  pF)

| Parameter  | Symbol                         | Min | Max       | Unit          |
|--|--------------------------------|-----|-----------|---------------|
| SCL Clock Frequency                                    | $f_{\text{scl}}$               | -   | 100       | kHz           |
| RST Rising Edge to Start                               | $t_{\text{irs}}$               | 500 | -         | ns            |
| Bus Free Time Between Transmissions                    | $t_{\text{buf}}$               | 4.7 | -         | $\mu\text{s}$ |
| Start Condition Hold Time (prior to first clock pulse) | $t_{\text{hdst}}$              | 4.0 | -         | $\mu\text{s}$ |
| Clock Low time   | $t_{\text{low}}$               | 4.7 | -         | $\mu\text{s}$ |
| Clock High Time  | $t_{\text{high}}$              | 4.0 | -         | $\mu\text{s}$ |
| Setup Time for Repeated Start Condition                | $t_{\text{sust}}$              | 4.7 | -         | $\mu\text{s}$ |
| SDA Hold Time from SCL Falling (Note 17)               | $t_{\text{hdd}}$               | 0   | -         | $\mu\text{s}$ |
| SDA Setup time to SCL Rising                           | $t_{\text{sud}}$               | 250 | -         | ns            |
| Rise Time of SCL and SDA                               | $t_{\text{rc}}, t_{\text{rc}}$ | -   | 1         | $\mu\text{s}$ |
| Fall Time SCL and SDA                                  | $t_{\text{fc}}, t_{\text{fc}}$ | -   | 300       | ns            |
| Setup Time for Stop Condition                          | $t_{\text{susp}}$              | 4.7 | -         | $\mu\text{s}$ |
| Acknowledge Delay from SCL Falling (Note 18)           | $t_{\text{ack}}$               | -   | (Note 19) | ns            |

Notes: 16. The Two-Wire Format is compatible with the I<sup>2</sup>C protocol.

17. Data must be held for sufficient time to bridge the transition time,  $t_{\text{fc}}$ , of SCL.

18. The acknowledge delay is based on MCLK and can limit the maximum transaction speed.

19.  $\frac{5}{256 \times F_s}$  for Single-Speed Mode,  $\frac{5}{128 \times F_s}$  for Double-Speed Mode,  $\frac{5}{64 \times F_s}$  for Quad-Speed Mode.

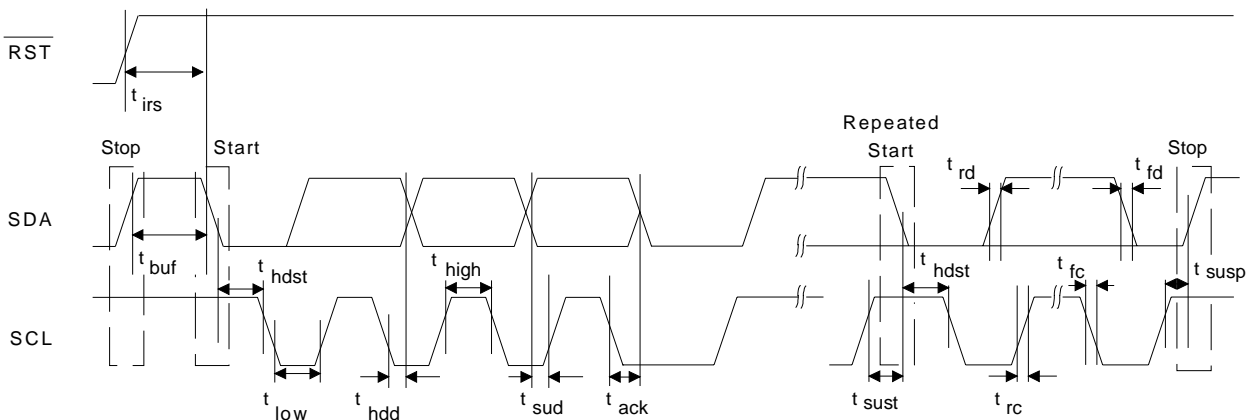


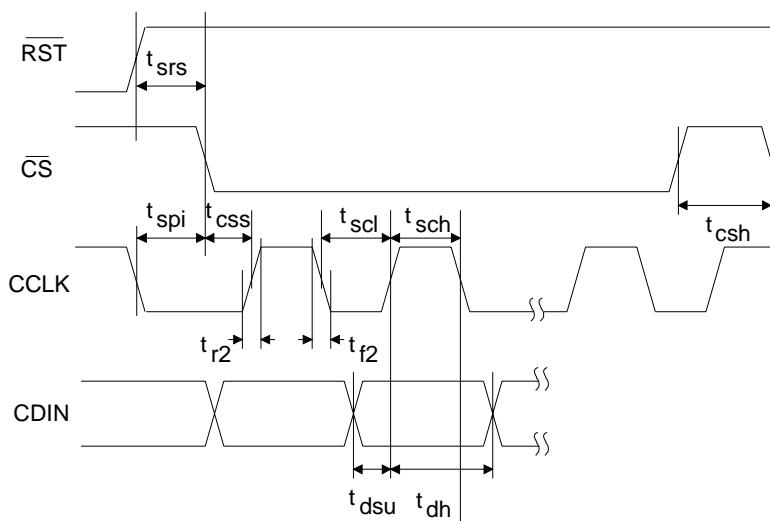
Figure 2. Control Port Timing - Two-Wire Format

## SWITCHING CHARACTERISTICS - CONTROL PORT - SPI FORMAT

(For -KS & -KZ parts  $T_A = -10$  to  $+70^\circ\text{C}$ ; for -BS & -BZ parts  $T_A = -40$  to  $+85^\circ\text{C}$ ; VLC = 1.7 V - 5.5 V; Inputs: Logic 0 = GND, Logic 1 = VLC,  $C_L = 30$  pF)

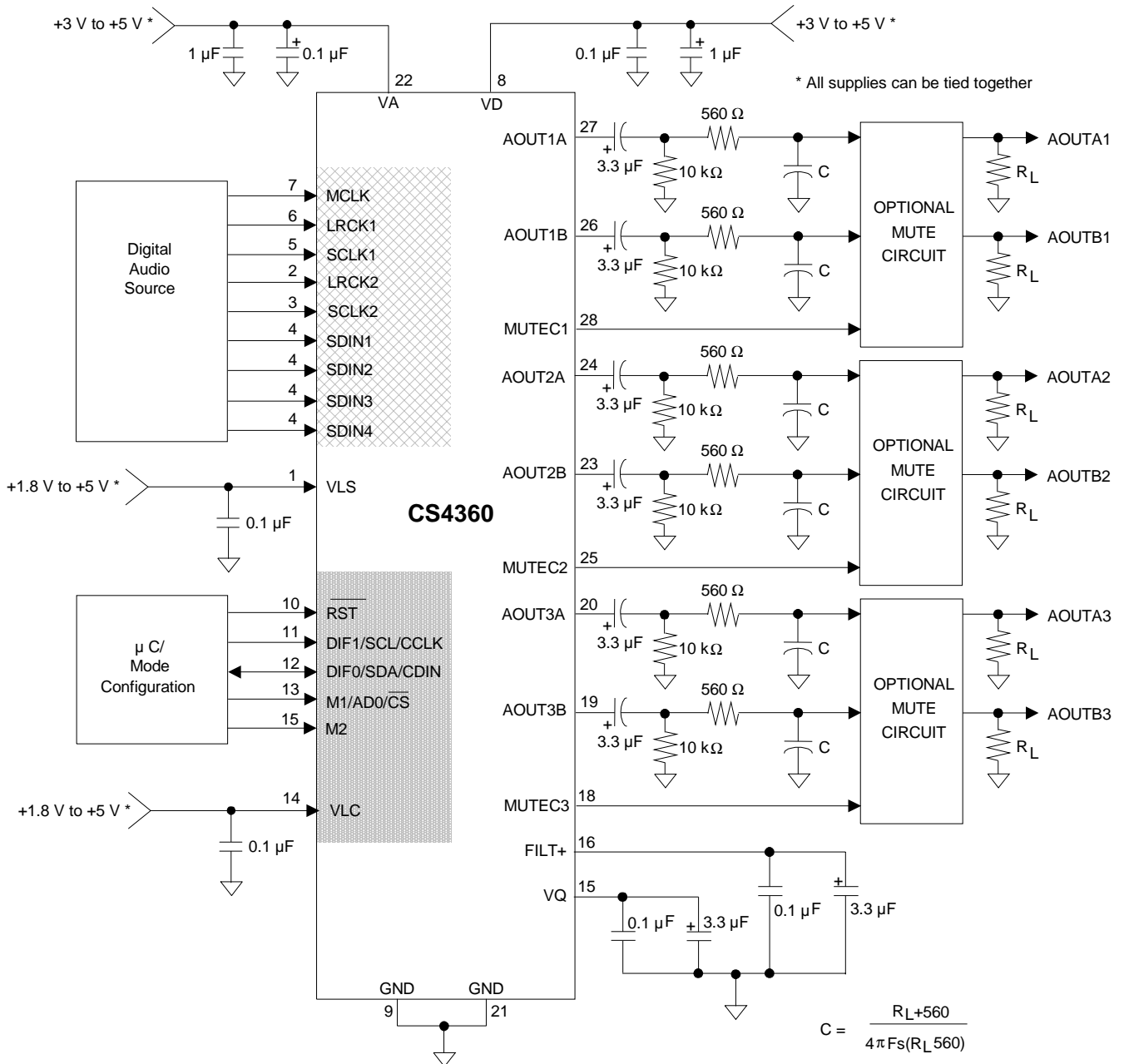
| Parameter                               | Symbol            | Min | Max | Unit          |
|---|-------------------|-----|-----|---------------|
| CCLK Clock Frequency                    | $f_{\text{sclk}}$ | -   | 6   | MHz           |
| RST Rising Edge to CS Falling           | $t_{\text{srs}}$  | 500 | -   | ns            |
| CCLK Edge to CS Falling (Note 20)       | $t_{\text{spi}}$  | 500 | -   | ns            |
| CS High Time Between Transmissions      | $t_{\text{csh}}$  | 1.0 | -   | $\mu\text{s}$ |
| CS Falling to CCLK Edge                 | $t_{\text{css}}$  | 20  | -   | ns            |
| CCLK Low Time                           | $t_{\text{scl}}$  | 66  | -   | ns            |
| CCLK High Time                          | $t_{\text{sch}}$  | 66  | -   | ns            |
| CDIN to CCLK Rising Setup Time          | $t_{\text{dsu}}$  | 40  | -   | ns            |
| CCLK Rising to DATA Hold Time (Note 21) | $t_{\text{dh}}$   | 15  | -   | ns            |
| Rise Time of CCLK and CDIN (Note 22)    | $t_{r2}$          | -   | 100 | ns            |
| Fall Time of CCLK and CDIN (Note 22)    | $t_{f2}$          | -   | 100 | ns            |

- Notes: 20.  $t_{\text{spi}}$  only needed before first falling edge of  $\overline{\text{CS}}$  after  $\overline{\text{RST}}$  rising edge.  $t_{\text{spi}} = 0$  at all other times.  
 21. Data must be held for sufficient time to bridge the transition time of CCLK.  
 22. For  $F_{\text{SCK}} < 1$  MHz.



**Figure 3. Control Port Timing - SPI Format**

**2. TYPICAL CONNECTION DIAGRAM**



**Figure 4. Typical Connection Diagram**

### 3. REGISTER QUICK REFERENCE

| Addr | Function                      | 7             | 6             | 5             | 4             | 3             | 2             | 1             | 0             |
|------|-------------------------------|---------------|---------------|---------------|---------------|---------------|---------------|---------------|---------------|
| 1h   | Mode Control 1<br>default     | AMUTE<br>1    | DIF2<br>0     | DIF1<br>0     | DIF0<br>0     | DEM1<br>0     | DEM0<br>0     | FM1<br>0      | FM0<br>0      |
| 2h   | Invert Signal<br>default      | Reserved<br>0 | Reserved<br>0 | INV_B3<br>0   | INV_A3<br>0   | INV_B2<br>0   | INV_A2<br>0   | INV_B1<br>0   | INV_A1<br>0   |
| 3h   | Mixing Control P1<br>default  | Reserved<br>0 | Reserved<br>0 | Reserved<br>0 | Reserved<br>0 | P1ATAPI3<br>1 | P1ATAPI2<br>0 | P1ATAPI1<br>0 | P1ATAPI0<br>1 |
| 4h   | Mixing Control P2<br>default  | Reserved<br>0 | Reserved<br>0 | Reserved<br>0 | Reserved<br>0 | P2ATAPI3<br>1 | P2ATAPI2<br>0 | P2ATAPI1<br>0 | P2ATAPI0<br>1 |
| 5h   | Mixing Control P3<br>default  | Reserved<br>0 | Reserved<br>0 | Reserved<br>0 | Reserved<br>0 | P3ATAPI3<br>1 | P3ATAPI2<br>0 | P3ATAPI1<br>0 | P3ATAPI0<br>1 |
| 6h   | Volume Control A1<br>default  | A1_MUTE<br>0  | A1_VOL6<br>0  | A1_VOL5<br>0  | A1_VOL4<br>0  | A1_VOL3<br>0  | A1_VOL2<br>0  | A1_VOL1<br>0  | A1_VOL0<br>0  |
| 7h   | Volume Control B1<br>default  | B1_MUTE<br>0  | B1_VOL6<br>0  | B1_VOL5<br>0  | B1_VOL4<br>0  | B1_VOL3<br>0  | B1_VOL2<br>0  | B1_VOL1<br>0  | B1_VOL0<br>0  |
| 8h   | Volume Control A2<br>default  | A2_MUTE<br>0  | A2_VOL6<br>0  | A2_VOL5<br>0  | A2_VOL4<br>0  | A2_VOL3<br>0  | A2_VOL2<br>0  | A2_VOL1<br>0  | A2_VOL0<br>0  |
| 9h   | Volume Control B2<br>default  | B2_MUTE<br>0  | B2_VOL6<br>0  | B2_VOL5<br>0  | B2_VOL4<br>0  | B2_VOL3<br>0  | B2_VOL2<br>0  | B2_VOL1<br>0  | B2_VOL0<br>0  |
| 0Ah  | Volume Control A3<br>default  | A3_MUTE<br>0  | A3_VOL6<br>0  | A3_VOL5<br>0  | A3_VOL4<br>0  | A3_VOL3<br>0  | A3_VOL2<br>0  | A3_VOL1<br>0  | A3_VOL0<br>0  |
| 0Bh  | Volume Control B3<br>default  | B3_MUTE<br>0  | B3_VOL6<br>0  | B3_VOL5<br>0  | B3_VOL4<br>0  | B3_VOL3<br>0  | B3_VOL2<br>0  | B3_VOL1<br>0  | B3_VOL0<br>0  |
| 0Ch  | Mode Control 2<br>default     | SZC1<br>1     | SZC0<br>0     | CPEN<br>0     | PDN<br>1      | POPG<br>1     | FREEZE<br>0   | MCLKDIV<br>0  | SNGLVOL<br>0  |
| 0Dh  | Revision Indicator<br>default | Reserved<br>0 | Reserved<br>0 | Reserved<br>0 | Reserved<br>0 | REV3<br>X     | REV2<br>X     | REV1<br>X     | REV0<br>X     |

## 4. REGISTER DESCRIPTIONS

Note: All registers are read/write in Two-Wire mode and write only in SPI, unless otherwise noted.

### 4.1 Mode Control 1 (address 01h)

|          |          |          |          |          |          |          |          |
|----------|----------|----------|----------|----------|----------|----------|----------|
| <b>7</b> | <b>6</b> | <b>5</b> | <b>4</b> | <b>3</b> | <b>2</b> | <b>1</b> | <b>0</b> |
| AMUTE    | DIF2     | DIF1     | DIF0     | DEM1     | DEM0     | FM1      | FM0      |
| 1        | 0        | 0        | 0        | 0        | 0        | 0        | 0        |

#### 4.1.1 AUTO-MUTE (AMUTE)

*Default = 1*

0 - Disabled

1 - Enabled

*Function:*

The Digital-to-Analog converter output will mute following the reception of 8192 consecutive audio samples of static 0 or -1. A single sample of non-static data will release the mute. Detection and muting is done independently for each channel. The quiescent voltage on the output will be retained and the Mute Control pin will go active during the mute period. The muting function is affected, similar to volume control changes, by the Soft and Zero Cross bits in the Power and Muting Control register.

#### 4.1.2 DIGITAL INTERFACE FORMAT (DIF)

*Default = 000 - Format 0 (Left Justified, up to 24-bit data)*

*Function:*

The required relationship between the Left/Right clock, serial clock and serial data is defined by the Digital Interface Format and the options are detailed in Figures 17-22.

| DIF2 | DIF1 | DIF0 | DESCRIPTION                         | Format | FIGURE |
|------|------|------|-------------------------------------|--------|--------|
| 0    | 0    | 0    | Left Justified, up to 24-bit data,  | 0      | 17     |
| 0    | 0    | 1    | I <sup>2</sup> S, up to 24-bit data | 1      | 18     |
| 0    | 1    | 0    | Right Justified, 16-bit data        | 2      | 19     |
| 0    | 1    | 1    | Right Justified, 24-bit data        | 3      | 20     |
| 1    | 0    | 0    | Right Justified, 20-bit data        | 4      | 21     |
| 1    | 0    | 1    | Right Justified, 18-bit data        | 5      | 22     |
| 1    | 1    | 0    | Reserved                            |        |        |
| 1    | 1    | 1    | Reserved                            |        |        |

**Table 1. Digital Interface Formats - Control Port Mode**

### 4.1.3 DE-EMPHASIS CONTROL (DEM)

*Default = 00*

- 00 - Disabled
- 01 - 44.1 kHz
- 10 - 48 kHz
- 11 - 32 kHz

*Function:*

Selects the appropriate digital filter to maintain the standard 15  $\mu$ s/50  $\mu$ s digital de-emphasis filter response at 32, 44.1 or 48 kHz sample rates. (see Figure 23)

Note: De-emphasis is only available in Single-Speed Mode.

### 4.1.4 FUNCTIONAL MODE (FM)

*Default = 00*

- 00 - Single-Speed Mode (2 to 50 kHz sample rates)
- 01 - Double-Speed Mode (50 to 100 kHz sample rates)
- 10 - Quad-Speed Mode (100 to 200 kHz sample rates)
- 11 - Reserved

*Function:*

Selects the required range of input sample rates.

## 4.2 *Invert Signal (address 02h)*

| 7        | 6        | 5      | 4      | 3      | 2      | 1      | 0      |
|----------|----------|--------|--------|--------|--------|--------|--------|
| Reserved | Reserved | INV_B3 | INV_A3 | INV_B2 | INV_A2 | INV_B1 | INV_A1 |
| 0        | 0        | 0      | 0      | 0      | 0      | 0      | 0      |

### 4.2.1 INVERT SIGNAL POLARITY (INV\_XX)

*Default = 0*

- 0 - Disabled
- 1 - Enabled

*Function:*

When enabled, these bits invert the signal polarity for each of their respective channels.

### 4.3 *Mixing Control Pair 1 (Channels A1 & B1) (address 03h)*

*Mixing Control Pair 2 (Channels A2 & B2) (address 04h)*

*Mixing Control Pair 3 (Channels A3 & B3) (address 05h)*

| 7        | 6        | 5        | 4        | 3        | 2        | 1        | 0        |
|----------|----------|----------|----------|----------|----------|----------|----------|
| Reserved | Reserved | Reserved | Reserved | PxATAPI3 | PxATAPI2 | PxATAPI1 | PxATAPI0 |
| 0        | 0        | 0        | 0        | 1        | 0        | 0        | 1        |

### 4.3.1 ATAPI CHANNEL MIXING AND MUTING (ATAPI)

Default = 1001 - AOUTAx = L, AOUTBx = R (Stereo)

*Function:*

The CS4360 implements the channel mixing functions of the ATAPI CD-ROM specification. Refer to Table 2 and Figure 24 for additional information.

Note: All mixing functions occur prior to the digital volume control. Mixing only occurs in channel pairs.

| ATAPI3 | ATAPI2 | ATAPI1 | ATAPI0 | AOUTAx    | AOUTBx    |
|--------|--------|--------|--------|-----------|-----------|
| 0      | 0      | 0      | 0      | MUTE      | MUTE      |
| 0      | 0      | 0      | 1      | MUTE      | R         |
| 0      | 0      | 1      | 0      | MUTE      | L         |
| 0      | 0      | 1      | 1      | MUTE      | [(L+R)/2] |
| 0      | 1      | 0      | 0      | R         | MUTE      |
| 0      | 1      | 0      | 1      | R         | R         |
| 0      | 1      | 1      | 0      | R         | L         |
| 0      | 1      | 1      | 1      | R         | [(L+R)/2] |
| 1      | 0      | 0      | 0      | L         | MUTE      |
| 1      | 0      | 0      | 1      | L         | R         |
| 1      | 0      | 1      | 0      | L         | L         |
| 1      | 0      | 1      | 1      | L         | [(L+R)/2] |
| 1      | 1      | 0      | 0      | [(L+R)/2] | MUTE      |
| 1      | 1      | 0      | 1      | [(L+R)/2] | R         |
| 1      | 1      | 1      | 0      | [(L+R)/2] | L         |
| 1      | 1      | 1      | 1      | [(L+R)/2] | [(L+R)/2] |

**Table 2. ATAPI Decode**

### 4.4 Volume Control (addresses 06h - 0Bh)

| 7       | 6       | 5       | 4       | 3       | 2       | 1       | 0       |
|---------|---------|---------|---------|---------|---------|---------|---------|
| xx_MUTE | xx_VOL6 | xx_VOL5 | xx_VOL4 | xx_VOL3 | xx_VOL2 | xx_VOL1 | xx_VOL0 |
| 0       | 0       | 0       | 0       | 1       | 0       | 0       | 1       |

#### 4.4.1 MUTE (MUTE)

*Default = 0*

0 - Disabled

1 - Enabled

*Function:*

The Digital-to-Analog converter output will mute when enabled. The quiescent voltage on the output will be retained. The muting function is effected, similar to attenuation changes, by the Soft and Zero Cross bits. The MUTE pin will go active during the mute period if the Mute function is enabled for both channels in the pair.



#### 4.4.2 VOLUME CONTROL (XX\_VOL)

Default = 0

*Function:*

The Digital Volume Control registers allow independent control of the signal levels in 1 dB increments from 0 to -119 dB. Volume settings are decoded as shown in Table 3. The volume changes are implemented as dictated by the Soft Ramp and Zero Cross bits. All volume settings less than -119 dB are equivalent to enabling the MUTE bit.

| Binary Code | Decimal Value | Volume Setting |
|-------------|---------------|----------------|
| 0001010     | 0             | dB             |
| 0010100     | -20           | -20 dB         |
| 0101000     | -40           | -40 dB         |
| 0111100     | -60           | -60 dB         |
| 1011010     | -90           | -90 dB         |

**Table 3. Example Digital Volume Settings**

#### 4.5 Mode Control 2 (address 0Dh)

| 7    | 6    | 5    | 4   | 3    | 2      | 1       | 0       |
|------|------|------|-----|------|--------|---------|---------|
| SZC1 | SZC0 | CPEN | PDN | POPG | FREEZE | MCLKDIV | SNGLVOL |
| 1    | 0    | 0    | 1   | 1    | 0      | 0       | 0       |

#### 4.5.1 SOFT RAMP AND ZERO CROSS CONTROL (SZC)

*Default = 10*

00 - Immediate Change

01 - Zero Cross

10 - Soft Ramp

11 - Soft Ramp and Zero Cross

*Function:*

Immediate Change

When Immediate Change is selected all level changes will be implemented immediately in one step.

Zero Cross

Zero Cross Enable dictates that signal level changes, either by attenuation changes or muting, will occur on a signal zero crossing to minimize audible artifacts. The requested level change will occur after a timeout period between 512 and 1024 sample periods (10.7 ms to 21.3 ms at 48 kHz sample rate) if the signal does not encounter a zero crossing. The zero cross function is independently monitored and implemented for each channel.

Soft Ramp

Soft Ramp allows level changes, both muting and attenuation, to be implemented by incrementally ramping, in 1/8 dB steps, from the current level to the new level at a rate of 1 dB per 8 left/right clock periods.

Soft Ramp and Zero Cross

Soft Ramp and Zero Cross dictates that signal level changes, either by attenuation changes or muting, will occur in 1/8 dB steps and will be implemented on successive signal zero crossings. The 1/8 dB level changes will occur after timeout periods between 512 and 1024 sample periods (10.7 ms to 21.3 ms at 48 kHz sample rate) if the signal does not encounter zero crossings. The zero cross function is independently monitored and implemented for each channel.

#### 4.5.2 CONTROL PORT ENABLE (CPEN)

*Default = 0*

0 - Disabled

1 - Enabled

*Function:*

The Control Port will become active and reset to the default settings when this function is enabled.

#### 4.5.3 POWER DOWN (PDN)

*Default = 1*

0 - Disabled

1 - Enabled

*Function:*

The entire device will enter a low-power state when this function is enabled, and the contents of the control registers are retained in this mode. The power-down bit defaults to 'enabled' on power-up and must be disabled before normal operation in Control Port mode can occur.

#### 4.5.4 POPGUARD<sup>®</sup> TRANSIENT CONTROL (POPG)

*Default = 1*

0 - Disabled

1 - Enabled

*Function:*

The PopGuard<sup>®</sup> Transient Control allows the quiescent voltage to slowly ramp to and from 0 volts to the quiescent voltage during power-on or power-off when this function is enabled. Please see section 6.4 for implementation details.

#### 4.5.5 FREEZE CONTROLS (FREEZE)

*Default = 0*

0 - Disabled

1 - Enabled

*Function:*

This function allows modifications to be made to the registers without the changes taking effect until the FREEZE is disabled. To make multiple changes in the control port registers take effect simultaneously, enable the FREEZE bit, make all register changes, then disable the FREEZE bit.

#### 4.5.6 MASTER CLOCK DIVIDE ENABLE (MCLKDIV)

*Default = 0*

0 - Disabled

1 - Enabled

*Function:*

The MCLKDIV bit enables a circuit which divides the externally applied MCLK signal by 2 prior to all other internal circuitry.

**4.5.7 SINGLE VOLUME CONTROL (SNGLVOL)**

*Default = 0*

0 - Disabled

1 - Enabled

*Function:*

The individual channel volume levels are independently controlled by their respective Volume Control Bytes when this function is disabled. The volume on all channels is determined by the A1 Channel Volume Control Byte, and the other Volume Control Bytes are ignored when this function is enabled.

**4.6 Revision Register (Read Only) (address 0Dh)**

| <b>7</b> | <b>6</b> | <b>5</b> | <b>4</b> | <b>3</b> | <b>2</b> | <b>1</b> | <b>0</b> |
|----------|----------|----------|----------|----------|----------|----------|----------|
| Reserved | Reserved | Reserved | Reserved | REV3     | REV2     | REV1     | REV0     |
| 0        | 0        | 0        | 0        | X        | X        | X        | X        |

**4.6.1 REVISION INDICATOR (REV) [READ ONLY]**

*Default = none*

0001 - Revision A

0010 - Revision B

0011 - Revision C

etc.

*Function:*

This read-only register indicates the revision level of the device.

## 5. PIN DESCRIPTION

|                     |                      |      |      |               |                            |
|---------------------|----------------------|------|------|---------------|----------------------------|
| Serial Audio Power  | <b>VLS</b>           | □ 1  | 28 □ | <b>MUTE1</b>  | Mute Control 1             |
| Serial Data Input 1 | <b>SDIN1</b>         | □ 2  | 27 □ | <b>AOUTA1</b> | Analog Output A1           |
| Serial Data Input 2 | <b>SDIN2</b>         | □ 3  | 26 □ | <b>AOUTB1</b> | Analog Output B1           |
| Serial Data Input 3 | <b>SDIN3</b>         | □ 4  | 25 □ | <b>MUTE2</b>  | Mute Control 2             |
| Serial Clock        | <b>SCLK</b>          | □ 5  | 24 □ | <b>AOUTA2</b> | Analog Output A2           |
| Left/Right Clock    | <b>LRCK</b>          | □ 6  | 23 □ | <b>AOUTB2</b> | Analog Output B2           |
| Master Clock        | <b>MCLK</b>          | □ 7  | 22 □ | <b>VA</b>     | Analog Power               |
| Digital Power       | <b>VD</b>            | □ 8  | 21 □ | <b>GND</b>    | Ground                     |
| Ground              | <b>GND</b>           | □ 9  | 20 □ | <b>AOUTA3</b> | Analog Output A3           |
| Reset               | <b>RST</b>           | □ 10 | 19 □ | <b>AOUTB3</b> | Analog Output B3           |
| DIF1 / SCL/ CCLK    | <b>DIF1/SCL/CCLK</b> | □ 11 | 18 □ | <b>MUTE3</b>  | Mute Control 3             |
| DIF0 / SDA / CDIN   | <b>DIF0/SDA/CDIN</b> | □ 12 | 17 □ | <b>VQ</b>     | Quiescent Voltage          |
| Mode1 / AD0 / CS    | <b>M1/AD0/CS</b>     | □ 13 | 16 □ | <b>FILT+</b>  | Positive Voltage Reference |
| Control Port Power  | <b>VLC</b>           | □ 14 | 15 □ | <b>M2</b>     | Mode 2                     |

| Pin Name                                     | #           | Pin Description   |
|--|-------------|---|
| <b>VLS</b>                                   | 1           | <b>Serial Audio Interface Power (Input)</b> - Determines the required signal level for the serial audio interface. Refer to the Recommended Operating Conditions for appropriate voltages. Applies to pins 2-7.   |
| <b>SDIN1</b><br><b>SDIN2</b><br><b>SDIN3</b> | 2<br>3<br>4 | <b>Serial Audio Data Input (Input)</b> - Input for two's complement serial audio data. SDIN1 corresponds to AOUT1x, SDIN2 corresponds to AOUT2x and SDIN3 corresponds to AOUT3x.  |
| <b>SCLK</b>                                  | 5           | <b>Serial Clock (Input)</b> - Serial clock for the serial audio interface.  |
| <b>LRCK</b>                                  | 6           | <b>Left / Right Clock (Input)</b> - Determines which channel, Left or Right, is currently active on the serial audio data line. The frequency of the left/right clock must be at the audio sample rate, Fs.   |
| <b>MCLK</b>                                  | 7           | <b>Master Clock (Input)</b> - Clock source for the delta-sigma modulator and digital filters. Table 6 illustrates several standard audio sample rates and the required master clock frequency.  |
| <b>VD</b>                                    | 8           | <b>Digital Power (Input)</b> - Positive power supply for the digital section. Refer to the Recommended Operating Conditions for appropriate voltages.   |
| <b>GND</b>                                   | 9<br>21     | <b>Ground (Input)</b> - Ground reference. Should be connected to analog ground.   |
| <b>RST</b>                                   | 10          | <b>Reset (Input)</b> - The device enters a low power mode and all internal registers are reset to their default settings when low. The control port cannot be accessed when Reset is low.   |
| <b>VLC</b>                                   | 14          | <b>Control Port Interface Power (Input)</b> - Determines the required signal level for the control port and provides power for bidirectional control port pins. Refer to the Recommended Operating Conditions for appropriate voltages. Applies to pins 10-13 and 15. |
| <b>FILT+</b>                                 | 16          | <b>Positive Voltage Reference (Output)</b> - Positive reference voltage for the internal sampling circuits. Requires the capacitive decoupling to GND as shown in the Typical Connection Diagram.   |

|                |    |   |
|----------------|----|---|
| <b>VQ</b>      | 17 | <b>Quiescent Voltage (Output)</b> - Filter connection for internal quiescent voltage. VQ must be capacitively coupled to analog ground, as shown in the Typical Connection Diagram. The nominal voltage level is specified in the Analog Characteristics and Specifications section. VQ presents an appreciable source impedance and any current drawn from this pin will alter device performance. However, VQ can be used to bias the analog circuitry assuming there is no AC signal component and the DC current is less than the maximum specified in the Analog Characteristics and Specifications section. |
| <b>VA</b>      | 22 | <b>Analog Power (Input)</b> - Positive power supply for the analog section. Refer to the Recommended Operating Conditions for appropriate voltages.   |
| <b>AOUTA1</b>  | 19 | <b>Analog Outputs (Output)</b> - The full scale analog line output level is specified in the Analog Characteristics specifications table.   |
| <b>AOUTB1</b>  | 20 |   |
| <b>AOUTA2</b>  | 23 |   |
| <b>AOUTB2</b>  | 24 |   |
| <b>AOUTA3</b>  | 26 |   |
| <b>AOUTB3</b>  | 27 |   |
| <b>MUTE C1</b> | 18 | <b>Mute Control (Output)</b> - The Mute Control pin goes high during power-up initialization, reset, muting, power-down or if the master clock to left/right clock frequency ratio is incorrect. This pin is intended to be used as a control for an external mute circuit to prevent the clicks and pops that can occur in any single supply system. The use of an external mute circuit is not mandatory but may be desired for designs requiring the absolute minimum in extraneous clicks and pops.   |
| <b>MUTE C2</b> | 25 |   |
| <b>MUTE C3</b> | 28 |   |

**Control Port Definitions**

|                 |    |   |
|-----------------|----|---|
| <b>SCL/CCLK</b> | 11 | <b>Serial Control Port Clock (Input)</b> - Serial clock for the serial control port. Requires an external pull-up resistor to the logic interface voltage in Two-Wire mode as shown in the Typical Connection Diagram.  |
| <b>SDA/CDIN</b> | 12 | <b>Serial Control Data (Input/Output)</b> - SDA is a data I/O line in Two-Wire format and requires an external pull-up resistor to the logic interface voltage, as shown in the Typical Connection Diagram. CDIN is the input data line for the control port interface in SPI format. |
| <b>AD0/CS</b>   | 13 | <b>Address Bit 0 (Two-Wire) / Control Port Chip Select (SPI) (Input/Output)</b> - AD0 is a chip address pin Two-Wire format; CS is the chip select signal for SPI format.   |

**Stand-Alone Definitions**

|             |    |  |
|-------------|----|--|
| <b>DIF1</b> | 11 | <b>Digital Interface Format (Input)</b> - The required relationship between the Left/Right clock, serial clock and serial data is defined by the Digital Interface Format selection. Refer to Table 4. |
| <b>DIF0</b> | 12 |  |

| DIF1 | DIF0 | DESCRIPTION                         |
|------|------|-------------------------------------|
| 0    | 0    | Left Justified, up to 24-bit data   |
| 0    | 1    | I <sup>2</sup> S, up to 24-bit data |
| 1    | 0    | Right Justified, 16-bit data        |
| 1    | 1    | Right Justified, 24-bit data        |

**Table 4. Digital Interface Formats - Stand Alone Mode**

|           |    |   |
|-----------|----|---|
| <b>M1</b> | 13 | <b>Mode Selection (Input)</b> - Determines the operational mode of the device as detailed in Table 5. |
| <b>M2</b> | 15 |   |

| M2 | M1 | MODE  |
|----|----|---|
| 0  | 0  | Single-Speed without de-emphasis (4 to 50 kHz sample rates) |
| 0  | 1  | Single-Speed with de-emphasis (32 to 48 kHz sample rates)   |
| 1  | 0  | Double-Speed (50 to 100 kHz sample rates)                   |
| 1  | 1  | Quad-Speed (100 to 200 kHz sample rates)                    |

**Table 5. Mode Selection**

| Sample Rate<br>(kHz) | MCLK (MHz) |         |         |         |         |
|----------------------|------------|---------|---------|---------|---------|
|                      | 256x       | 384x    | 512x    | 768x    | 1024x*  |
| 32                   | 8.1920     | 12.2880 | 16.3840 | 24.5760 | 32.7680 |
| 44.1                 | 11.2896    | 16.9344 | 22.5792 | 32.7680 | 45.1584 |
| 48                   | 12.2880    | 18.4320 | 24.5760 | 36.8640 | 49.1520 |

\* Requires MCLKDIV bit = 1

**Table 6. Single-Speed Mode Common Clock Frequencies**

| Sample Rate<br>(kHz) | MCLK (MHz) |         |         |         |         |
|----------------------|------------|---------|---------|---------|---------|
|                      | 128x       | 192x    | 256x    | 384x    | 512x*   |
| 64                   | 8.1920     | 12.2880 | 16.3840 | 24.5760 | 32.7680 |
| 88.2                 | 11.2896    | 16.9344 | 22.5792 | 33.8688 | 45.1584 |
| 96                   | 12.2880    | 18.4320 | 24.5760 | 36.8640 | 49.1520 |

\* Requires MCLKDIV bit = 1

**Table 7. Double-Speed Mode Common Clock Frequencies**

| Sample Rate<br>(kHz) | MCLK (MHz) |         |         |         |         |
|----------------------|------------|---------|---------|---------|---------|
|                      | 64x        | 96x     | 128x    | 192x    | 256x*   |
| 176.4                | 11.2896    | 16.9344 | 22.5792 | 33.8688 | 45.1584 |
| 192                  | 12.2880    | 18.4320 | 24.5760 | 36.8640 | 49.1520 |

\* Requires MCLKDIV bit = 1

**Table 8. Quad-Speed Mode Common Clock Frequencies**

## 6. APPLICATIONS

### 6.1 Grounding and Power Supply Decoupling

As with any high resolution converter, the CS4360 requires careful attention to power supply and grounding arrangements to optimize performance. Figure 4 shows the recommended power arrangement with VA, VD, VLS and VLC connected to clean supplies. Decoupling capacitors should be located as close to the device package as possible. If desired, all supply pins may be connected to the same supply, but a decoupling capacitor should still be placed on each supply pin.

### 6.2 Oversampling Modes

The CS4360 operates in one of three oversampling modes based on the input sample rate. Mode selection is determined by the FM pins in Stand-Alone mode or the FM bits in Control Port mode. Single-Speed mode supports input sample rates up to 50 kHz and uses a 128x oversampling ratio. Double-Speed mode supports input sample rates up to 100 kHz and uses an oversampling ratio of 64x. Quad-Speed mode supports input sample rates up to 200 kHz and uses an oversampling ratio of 32x.

### 6.3 Recommended Power-up Sequence

1. Hold  $\overline{RST}$  low until the power supply, master, and left/right clocks are stable. In this state, the control port is reset to its default settings and VQ will remain low.
2. Bring  $\overline{RST}$  high. The device will remain in a low power state with VQ low and will initiate the Stand-Alone power-up sequence. The control port will be accessible at this time. If Control Port operation is desired, write the CPEN bit prior to the completion of the Stand-Alone power-up sequence, approximately 512 LRCK cycles in Single-Speed Mode (1024 LRCK cycles in Double-Speed Mode, and 2048 LRCK cycles in Quad-Speed Mode). Writing this bit will halt the Stand-

Alone power-up sequence and initialize the control port to its default settings. The desired register settings can be loaded while keeping the PDN bit set to 1.

3. If Control Port Mode is selected via the CPEN bit, set the PDN bit to 0 which will initiate the power-up sequence, which requires approximately 50  $\mu$ S when the POPG bit is set to 0. If the POPG bit is set to 1, see Section 6.4 for total power-up timing.

### 6.4 Popguard<sup>®</sup> Transient Control

The CS4360 uses a novel technique to minimize the effects of output transients during power-up and power-down. This technique, when used with external DC-blocking capacitors in series with the audio outputs, minimizes the audio transients commonly produced by single-ended single-supply converters.

When the device is initially powered-up, the audio outputs, AOUTAx and AOUTBx, are clamped to GND. Following a delay of approximately 1000 sample periods, each output begins to ramp toward the quiescent voltage. Approximately 10,000 left/right clock cycles later, the outputs reach VQ and audio output begins. This gradual voltage ramping allows time for the external DC-blocking capacitor to charge to the quiescent voltage, minimizing the power-up transient.

To prevent transients at power-down, the device must first enter its power-down state. When this occurs, audio output ceases and the internal output buffers are disconnected from AOUTAx and AOUTBx. In their place, a soft-start current sink is substituted which allows the DC-blocking capacitors to slowly discharge. Once this charge is dissipated, the power to the device may be turned off and the system is ready for the next power-on.

To prevent an audio transient at the next power-on, it is necessary to ensure that the DC-blocking capacitors have fully discharged before turning off

the power or exiting the power-down state. If not, a transient will occur when the audio outputs are initially clamped to GND. The time that the device must remain in the power-down state is related to the value of the DC-blocking capacitance. For example, with a 3.3  $\mu$ F capacitor, the minimum power-down time will be approximately 0.4 seconds.

Use of the Mute Control function is recommended for designs requiring the absolute minimum in extraneous clicks and pops. Also, use of the Mute Control function can enable the system designer to achieve idle channel noise/signal-to-noise ratios which are only limited by the external mute circuit. See the CDB4360 data sheet for a suggested mute circuit.

## 7. CONTROL PORT INTERFACE

The control port is used to load all the internal settings. The operation of the control port may be completely asynchronous with the audio sample rate. However, to avoid potential interference problems, the control port pins should remain static if no operation is required.

The CS4360 has MAP auto increment capability, enabled by the INCR bit in the MAP register, which is the MSB. If INCR is 0, then the MAP will stay constant for successive writes. If INCR is set to 1, then MAP will auto increment after each byte is written, allowing block reads or writes of successive registers.

### 7.1 Enabling the Control Port

On the CS4360 the control port pins are shared with stand-alone configuration pins. To enable the control port, the user must set the CPEN bit. This is done by performing a Two-Wire or SPI write. Once the control port is enabled, these pins are dedicated to control port functionality.

To prevent audible artifacts the CPEN bit (see Section 4.5.2) should be set prior to the completion of the Stand-Alone power-up sequence, approximately 512 LRCK cycles in Single-Speed Mode (1024

LRCK cycles in Double-Speed Mode, and 2048 LRCK cycles in Quad-Speed Mode). Writing this bit will halt the Stand-Alone power-up sequence and initialize the control port to its default settings. Note, the CPEN bit can be set any time after  $\overline{\text{RST}}$  goes high; however, setting this bit after the Stand-Alone power-up sequence has completed can cause audible artifacts.

### 7.2 Format Selection

The control port has 2 formats: SPI and Two-Wire, with the CS4360 operating as a slave device.

If Two-Wire operation is desired,  $\text{AD0}/\overline{\text{CS}}$  should be tied to VLS or GND. If the CS4360 ever detects a high to low transition on  $\text{AD0}/\overline{\text{CS}}$  after power-up and after the control port is activated, SPI format will be selected.

### 7.3 Two-Wire Format

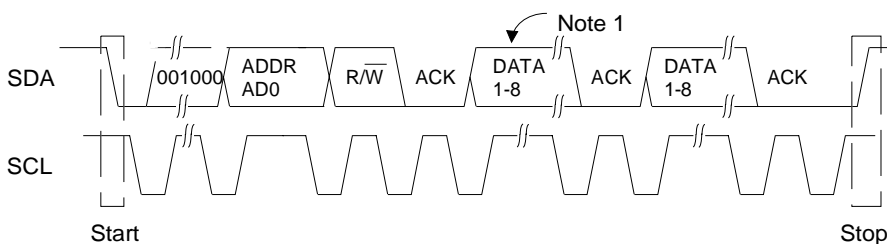
In Two-Wire Format, SDA is a bidirectional data line. Data is clocked into and out of the part by the clock, SCL, with a clock to data relationship as shown in Figure 5. The receiving device should send an acknowledge (ACK) after each byte received. There is no  $\overline{\text{CS}}$  pin. Pin AD0 form the partial chip address and should be tied to VLS or GND as required. The upper 6 bits of the 7 bit address field must be 001000.

Note, MCLK is required during all two-wire transactions. The Two-Wire format is compatible with the I<sup>2</sup>C protocol. Please see reference 2 for further details.

#### 7.3.1 Writing in Two-Wire Format

To communicate with the CS4360, initiate a START condition of the bus. Next, send the chip address. The eighth bit of the address byte is the  $\text{R}/\overline{\text{W}}$  bit (low for a write). The next byte is the Memory Address Pointer, MAP, which selects the register to be read or written. The MAP is then followed by the data to be written. To write multiple registers, continue providing a clock and data,





Note: If operation is a write, this byte contains the Memory Address Pointer, MAP.

**Figure 5. Control Port Timing, Two-Wire Format**

waiting for the CS4360 to acknowledge between each byte. To end the transaction, send a STOP condition.

**7.3.2 Reading in Two-Wire Format**

To communicate with the CS4360, initiate a START condition of the bus. Next, send the chip address. The eighth bit of the address byte is the R/W bit (high for a read). The contents of the register pointed to by the MAP will be output after the chip address. To read multiple registers, continue providing a clock and issue an ACK after each byte. To end the transaction, send a STOP condition.

**7.4 SPI Format**

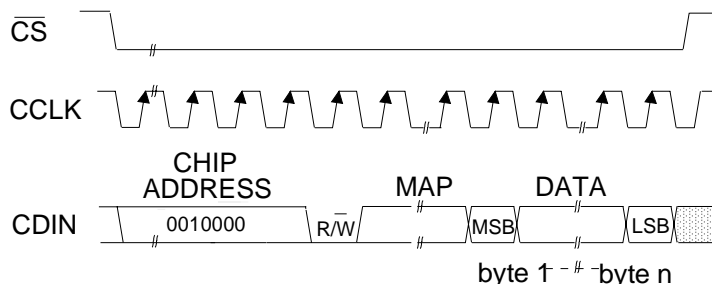
In SPI format, CS is the CS4360 chip select signal, CCLK is the control port bit clock, CDIN is the input data line from the microcontroller and the chip address is 0010000. CS, CCLK and CDIN are all

inputs and data is clocked in on the rising edge of CCLK.

Note that the CS4360 is write-only when in SPI format.

**7.4.1 Writing in SPI**

Figure 6 shows the operation of the control port in SPI format. To write to a register, bring CS low. The first 7 bits on CDIN form the chip address and must be 0010000. The eighth bit is a read/write indicator (R/W), which must be low to write. The next 8 bits form the Memory Address Pointer (MAP), which is set to the address of the register that is to be updated. The next 8 bits are the data which will be placed into register designated by the MAP. To write multiple registers, keep CS low and continue providing clocks on CCLK. End the read transaction by setting CS high.



MAP = Memory Address Pointer

**Figure 6. Control Port Timing, SPI Format**

7.5 *Memory Address Pointer (MAP)*

| 7    | 6        | 5        | 4        | 3    | 2    | 1    | 0    |
|------|----------|----------|----------|------|------|------|------|
| INCR | Reserved | Reserved | Reserved | MAP3 | MAP2 | MAP1 | MAP0 |
| 0    | 0        | 0        | 0        | 0    | 0    | 0    | 0    |

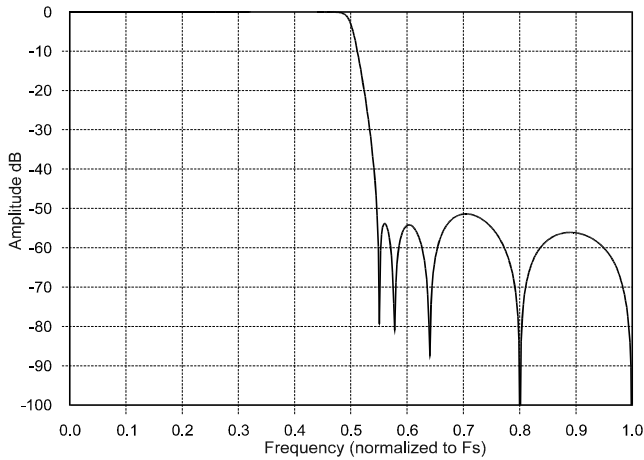
**7.5.1 INCR (AUTO MAP INCREMENT ENABLE)**

*Default = '0'*  
 0 - Disabled  
 1 - Enabled

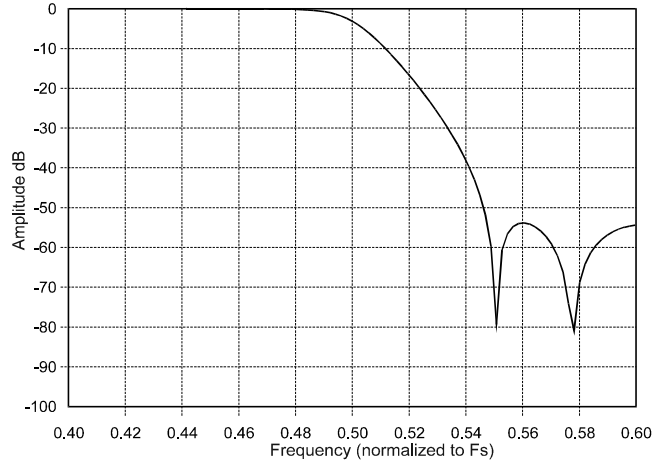
**7.5.2 MAP (MEMORY ADDRESS POINTER)**

*Default = '0000'*

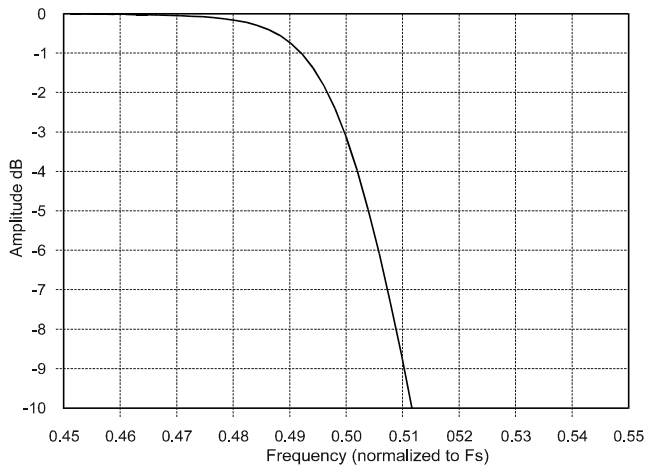




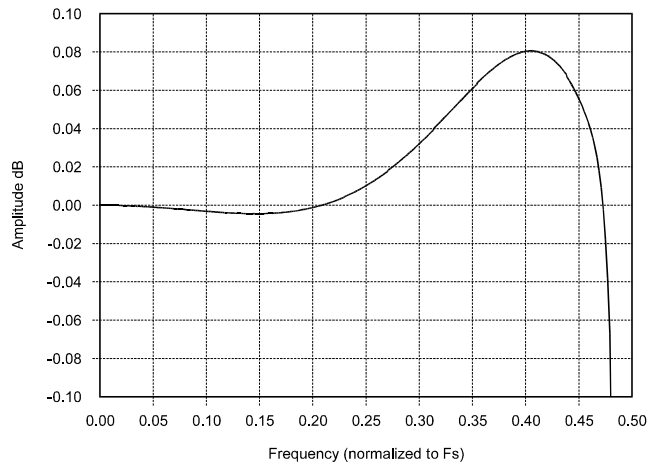
**Figure 7. Base-Rate Stopband Rejection**



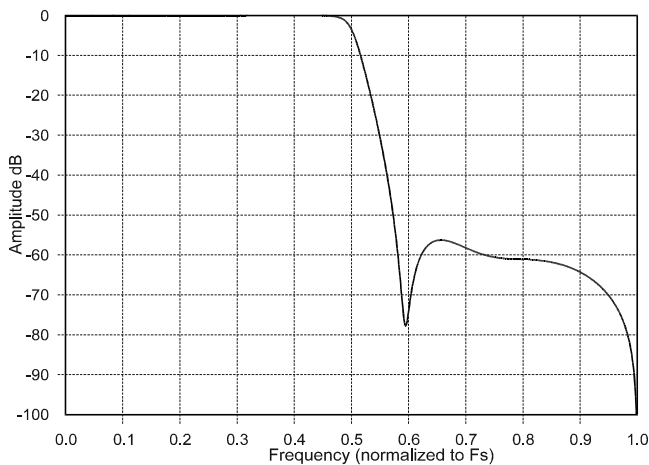
**Figure 8. Base-Rate Transition Band**



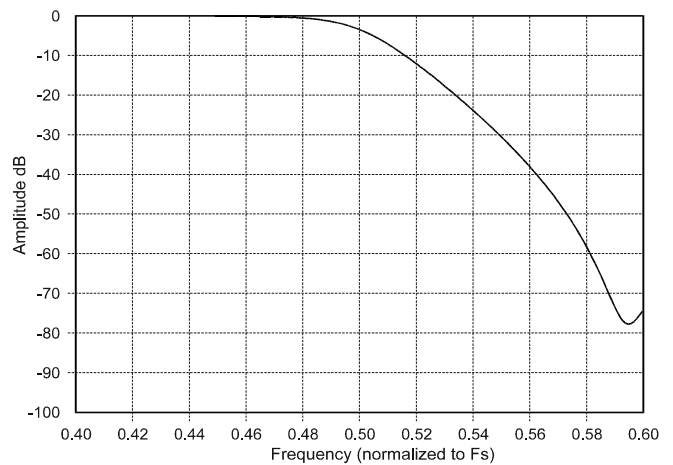
**Figure 9. Base-Rate Transition Band (Detail)**



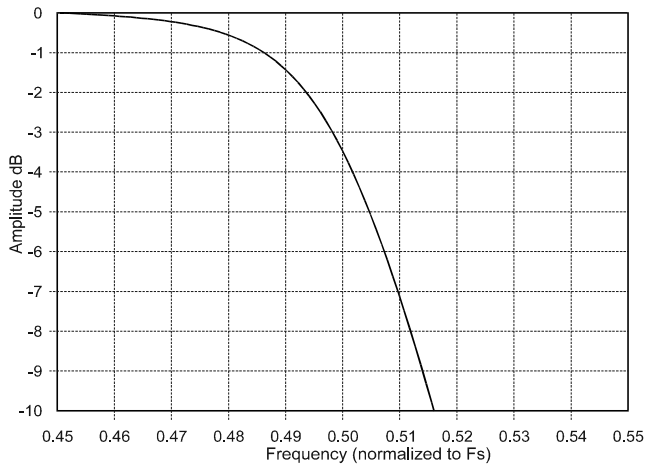
**Figure 10. Base-Rate Passband Ripple**



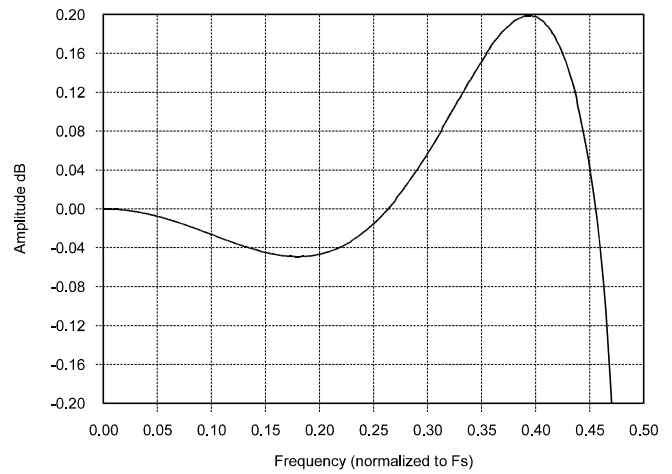
**Figure 11. High-Rate Stopband Rejection**



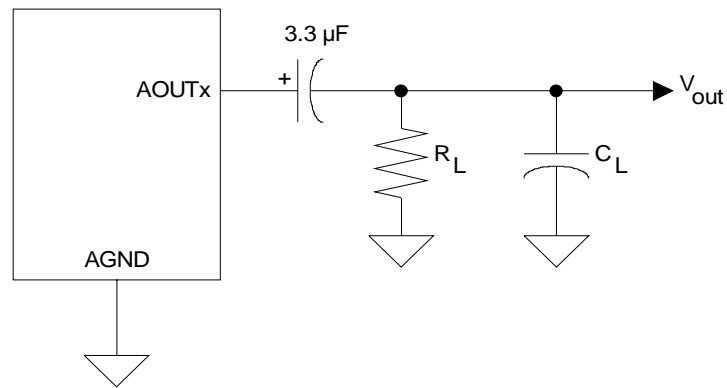
**Figure 12. High-Rate Transition Band**



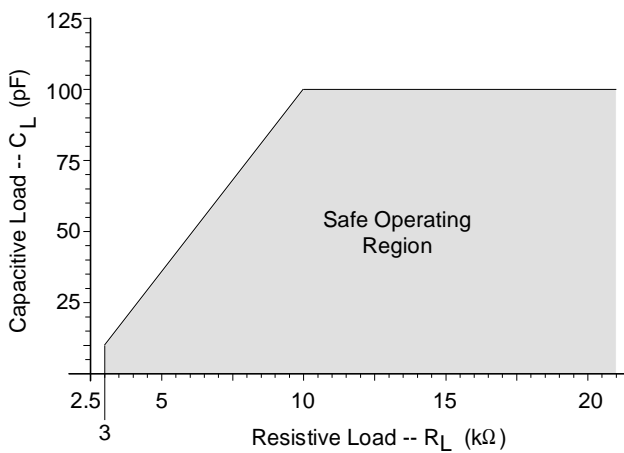
**Figure 13. High-Rate Transition Band (Detail)**



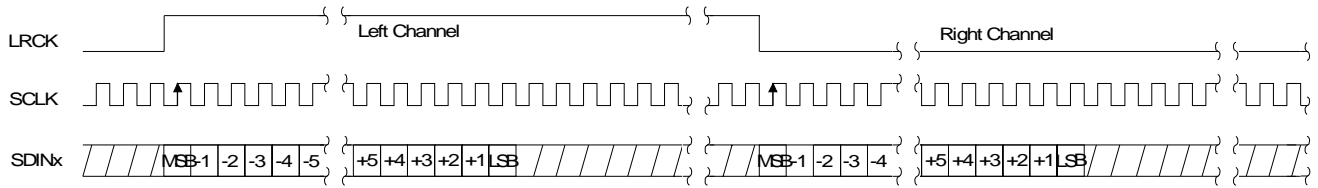
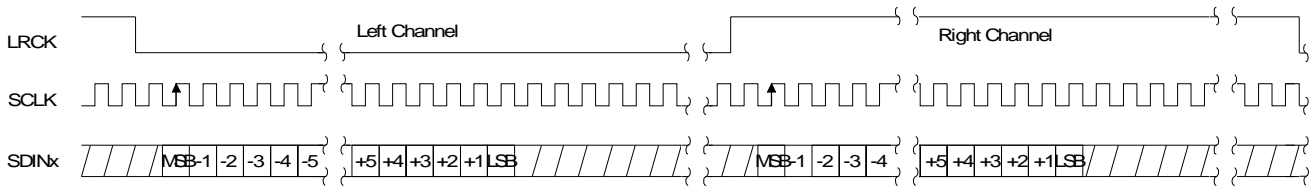
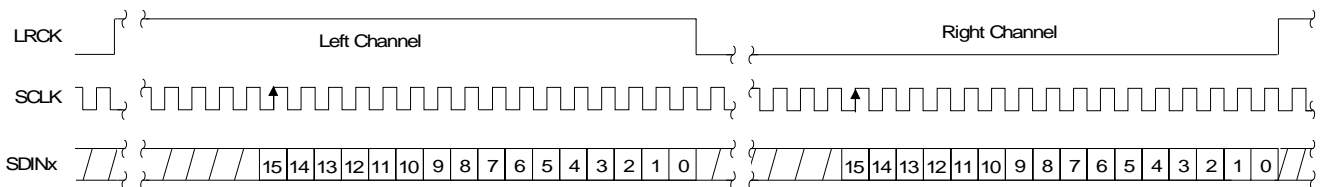
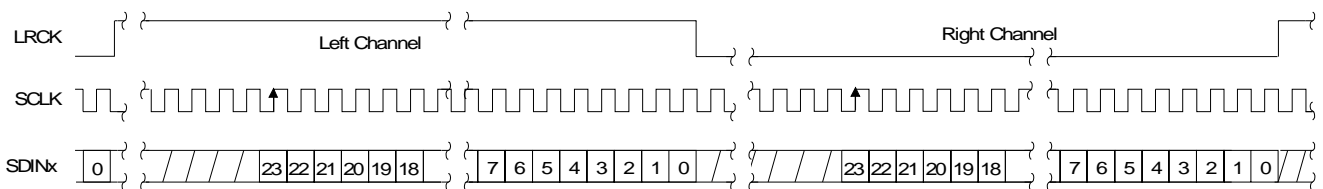
**Figure 14. High-Rate Passband Ripple**

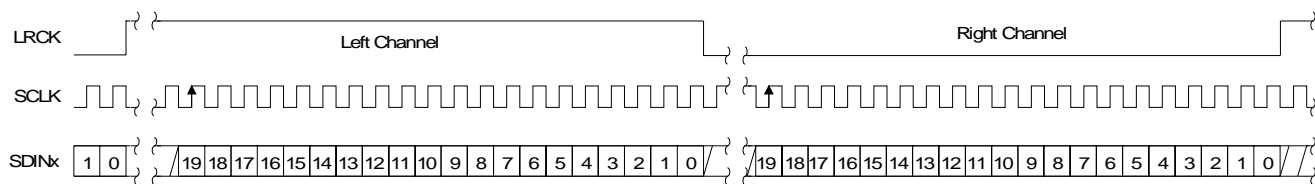


**Figure 15. Output Test Load**

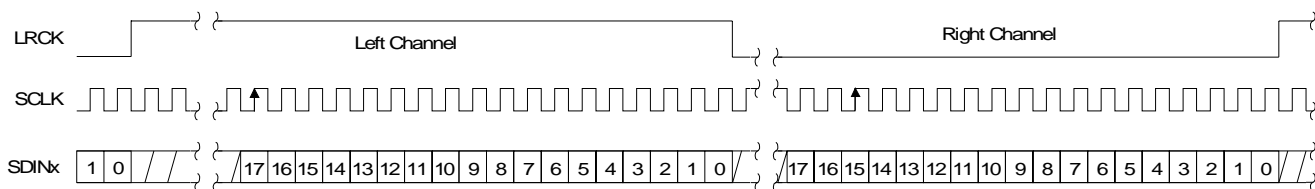


**Figure 16. Maximum Loading**

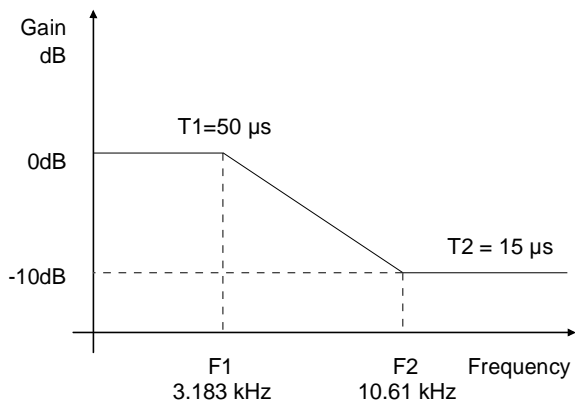

**Figure 17. CS4360 Format 0 - Left Justified up to 24-bit Data**

**Figure 18. CS4360 Format 1 - I<sup>2</sup>S up to 24-bit Data**

**Figure 19. CS4360 Format 2 - Right Justified 16-bit Data**

**Figure 20. CS4360 Format 3 - Right Justified 24-bit Data**



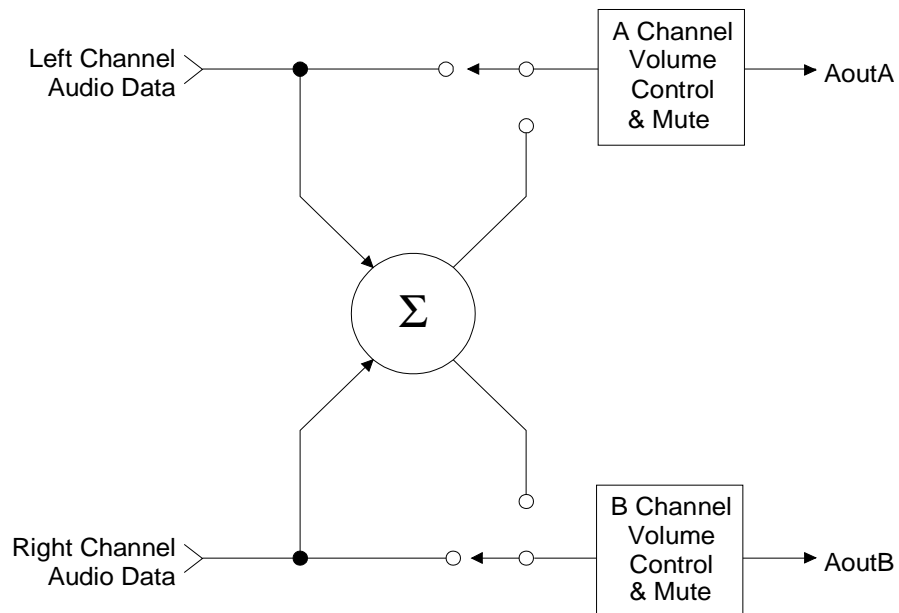
**Figure 21. CS4360 Format 4 - Right Justified 20-bit Data**



**Figure 22. CS4360 Format 5 - Right Justified 18-bit Data**



**Figure 23. De-Emphasis Curve**



**Figure 24. ATAPI Block Diagram**

## 8. PARAMETER DEFINITIONS

### Total Harmonic Distortion + Noise (THD+N)

The ratio of the rms value of the signal to the rms sum of all other spectral components over the specified bandwidth (typically 10Hz to 20kHz), including distortion components. Expressed in decibels.

### Dynamic Range

The ratio of the full scale rms value of the signal to the rms sum of all other spectral components over the specified bandwidth. Dynamic range is a signal-to-noise measurement over the specified bandwidth made with a -60 dBFS signal. 60 dB is then added to the resulting measurement to refer the measurement to full scale. This technique ensures that the distortion components are below the noise level and do not affect the measurement. This measurement technique has been accepted by the Audio Engineering Society, AES17-1991, and the Electronic Industries Association of Japan, EIAJ CP-307.

### Interchannel Isolation

A measure of crosstalk between the left and right channels. Measured for each channel at the converter's output with all zeros to the input under test and a full-scale signal applied to the other channel. Units in decibels.

### Interchannel Gain Mismatch

The gain difference between left and right channels. Units in decibels.

### Gain Error

The deviation from the nominal full scale analog output for a full scale digital input.

### Gain Drift

The change in gain value with temperature. Units in ppm/°C.

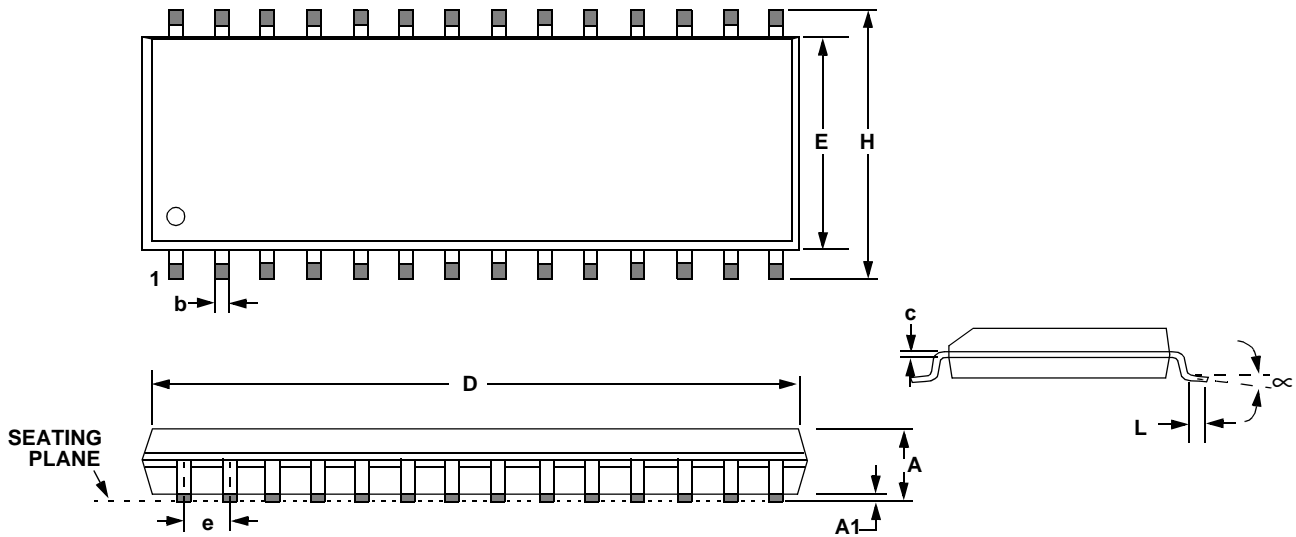
## 9. REFERENCES

- 1) "How to Achieve Optimum Performance from Delta-Sigma A/D & D/A Converters" by Steven Harris. Paper presented at the 93rd Convention of the Audio Engineering Society, October 1992.
- 2) CDB4360 Evaluation Board Datasheet
- 3) "The I<sup>2</sup>C Bus Specification: Version 2.0" Philips Semiconductors, December 1998.  
<http://www.semiconductors.philips.com>



**10. PACKAGE DIMENSIONS**

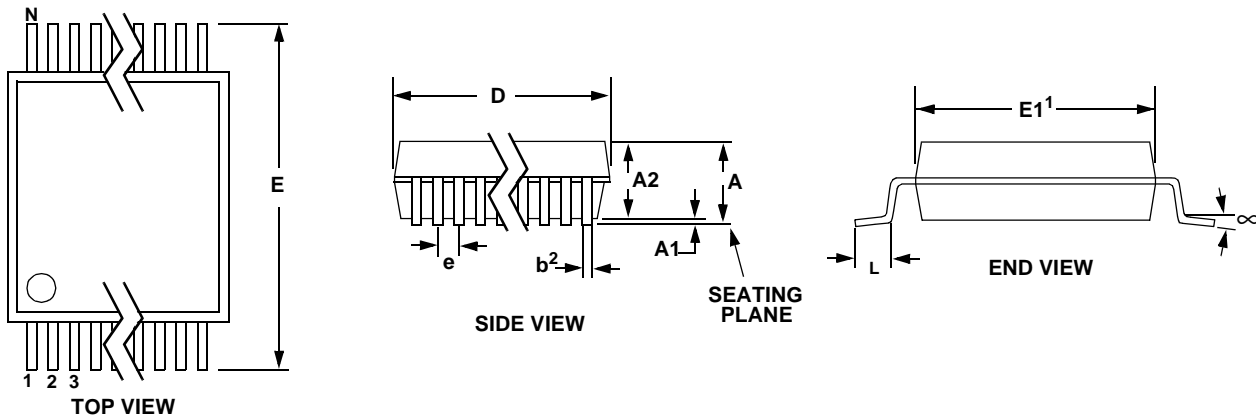
**28L SOIC (300 MIL BODY) PACKAGE DRAWING**



| DIM | INCHES |       |       | MILLIMETERS |       |       |
|-----|--------|-------|-------|-------------|-------|-------|
|     | MIN    | NOM   | MAX   | MIN         | NOM   | MAX   |
| A   | 0.093  | 0.098 | 0.104 | 2.35        | 2.50  | 2.65  |
| A1  | 0.004  | 0.008 | 0.012 | 0.10        | 0.20  | 0.30  |
| b   | 0.013  | 0.017 | 0.020 | 0.33        | 0.42  | 0.51  |
| C   | 0.009  | 0.011 | 0.013 | 0.23        | 0.28  | 0.32  |
| D   | 0.697  | 0.705 | 0.713 | 17.70       | 17.90 | 18.10 |
| E   | 0.291  | 0.295 | 0.299 | 7.40        | 7.50  | 7.60  |
| e   | 0.040  | 0.050 | 0.060 | 1.02        | 1.27  | 1.52  |
| H   | 0.394  | 0.407 | 0.419 | 10.00       | 10.34 | 10.65 |
| L   | 0.016  | 0.026 | 0.050 | 0.40        | 0.65  | 1.27  |
| ∞   | 0°     | 4°    | 8°    | 0°          | 4°    | 8°    |

**JEDEC #: MS-013**

Controlling Dimension is Millimeters

**28L TSSOP (4.4 mm BODY) PACKAGE DRAWING**


| DIM | INCHES    |           |           | MILLIMETERS |          |          | NOTE |
|-----|-----------|-----------|-----------|-------------|----------|----------|------|
|     | MIN       | NOM       | MAX       | MIN         | NOM      | MAX      |      |
| A   | --        | --        | 0.47      | --          | --       | 1.20     |      |
| A1  | 0.002     | 0.004     | 0.006     | 0.05        | 0.10     | 0.15     |      |
| A2  | 0.03150   | 0.035     | 0.04      | 0.80        | 0.90     | 1.00     |      |
| b   | 0.00748   | 0.0096    | 0.012     | 0.19        | 0.245    | 0.30     | 2,3  |
| D   | 0.378 BSC | 0.382 BSC | 0.386 BSC | 9.60 BSC    | 9.70 BSC | 9.80 BSC | 1    |
| E   | 0.248     | 0.2519    | 0.256     | 6.30        | 6.40     | 6.50     |      |
| E1  | 0.169     | 0.1732    | 0.177     | 4.30        | 4.40     | 4.50     | 1    |
| e   | --        | 0.026 BSC | --        | --          | 0.65 BSC | --       |      |
| L   | 0.020     | 0.024     | 0.029     | 0.50        | 0.60     | 0.75     |      |
| ∞   | 0°        | 4°        | 8°        | 0°          | 4°       | 8°       |      |

**JEDEC #: MO-153**
*Controlling Dimension is Millimeters.*

- Notes:
1. "D" and "E1" are reference datums and do not include mold flash or protrusions, but do include mold mismatch and are measured at the parting line, mold flash or protrusions shall not exceed 0.20 mm per side.
  2. Dimension "b" does not include dambar protrusion/intrusion. Allowable dambar protrusion shall be 0.13 mm total in excess of "b" dimension at maximum material condition. Dambar intrusion shall not reduce dimension "b" by more than 0.07 mm at least material condition.
  3. These dimensions apply to the flat section of the lead between 0.10 and 0.25 mm from lead tips.

• **Notes** •

---

SMART  
Analog™