

Low capacitance TVS for high speed lines such as xDSL

Datasheet - production data

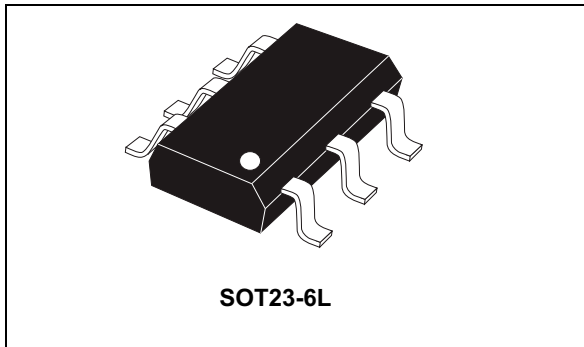

Description

DSL04 is designed to protect VDSL2 line drivers against surges defined in worldwide telecommunication standards. This device protects line drivers for CPE and DSLAM applications. The low capacitance makes it suitable from ADSL to VDSL2 data rates.

DSL04 is able to survive severe conditions even when used with downgraded or oscillating gas tube.

DSL04 is packaged in a SOT23-6L.

Features

- High surge capability to comply with GR-1089 and ITU-T K20/21
- Voltages from 5 to 24 V
- Low capacitance device: $C_{typ} = 1 \text{ pF}$
- RoHS package
- Low leakage current: $0.2 \text{ }\mu\text{A}$ at $25 \text{ }^\circ\text{C}$

Complies with the following standards

- Telcordia GR-1089
 - 2.5 kV 2/10 μs - 500 A 2/10 μs
 - AC power fault tests
- ITU-T K20/21/44
 - 6 kV 10/700 μs - 150 A 5/310 μs
 - Power induction tests
 - Power contact tests
- IEC 61000-4-2, level 4
 - 15 kV (air discharge)
 - 8 kV (contact discharge)
- IEC 61000-4-5, level 2
 - $\pm 1 \text{ kV}$, $42 \text{ }\Omega$
- MIL STD 883G-Method 3015-7: Class 3
 - 8 kV (human body model)

Figure 1. Functional diagram

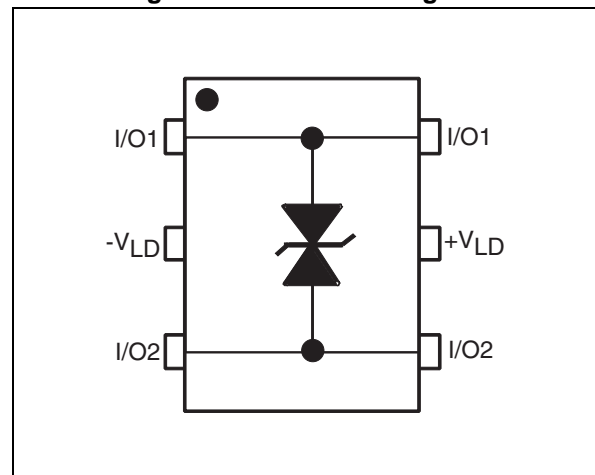

1 Characteristics

Table 1. Absolute ratings ($T_{amb} = 25\text{ °C}$)

Symbol	Parameter		Value	Unit
V_{pp}	Peak pulse voltage	IEC 61000-4-5 contact discharge	30	kV
I_{pp}	Peak pulse current	8/20 μ s	15	A
T_{stg}	Storage temperature range		-55 to 150	$^{\circ}\text{C}$
T_j	Operating junction temperature range		-40 to 125	$^{\circ}\text{C}$
T_L	Maximum temperature for soldering during 10s		260	$^{\circ}\text{C}$

Table 2. Electrical characteristics ($T_{amb} = 25\text{ °C}$)

Order code	$I_{RM} @ V_{RM}$		$V_{BR} @ I_{BR}$		$V_{CL} @ I_{PP}$ 8/20 μ s		C		ΔC
	Max. μ A	V	Min. V	mA	Max. V	A	Typ. ⁽¹⁾ pF	Max. ⁽¹⁾ pF	Typ. ⁽²⁾ pF
DSL04-005SC6	0.2	5	6.5	1	20	15	1	3	0.3
DSL04-008SC6	0.2	8	10	1	25	15	1	3	0.3
DSL04-010SC6	0.2	10	11	1	27	15	1	3	0.3
DSL04-012SC6	0.2	12	14	1	31	15	1	3	0.3
DSL04-016SC6	0.2	16	20	1	37	15	1	3	0.3
DSL04-018SC6	0.2	18	21	1	39	15	1	3	0.3
DSL04-020SC6	0.2	20	23	1	42	15	1	3	0.3
DSL04-022SC6	0.2	22	25	1	45	15	1	3	0.3
DSL04-024SC6	0.2	24	27	1	52	15	1	3	0.3

1. Test conditions: $V_R = 2\text{ V}$ bias, $V_{RMS} = 1\text{ V}$, $F = 1\text{ MHz}$

2. Measured between 1 V and V_{RM}

Figure 2. Leakage current versus junction temperature (typical values)

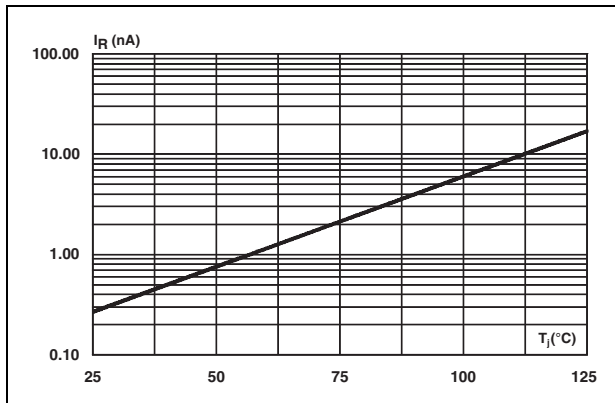

Figure 3. Junction capacitance versus reverse voltage applied (typical values)

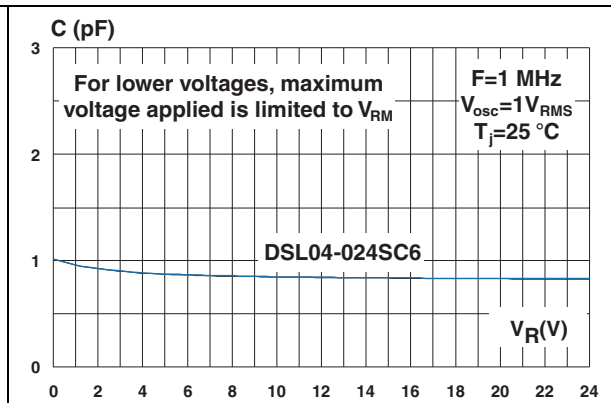
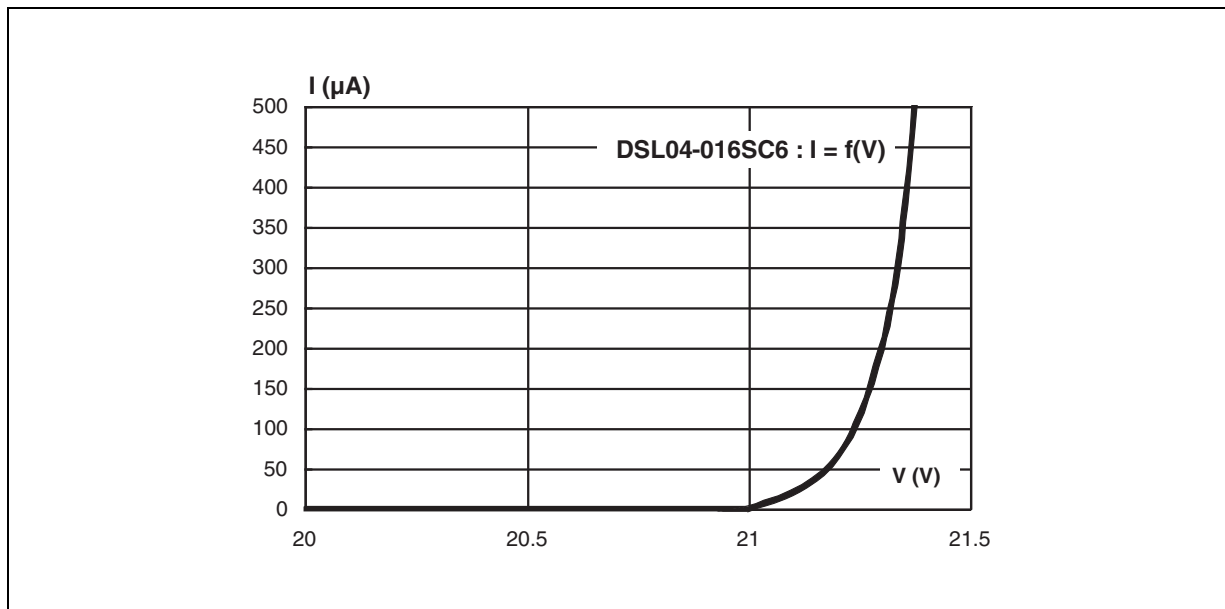

Figure 4. I / V characteristics (typical values)



2 Package information

- Epoxy meets UL94, V0
- Lead-free package

In order to meet environmental requirements, ST offers these devices in different grades of ECOPACK® packages, depending on their level of environmental compliance. ECOPACK® specifications, grade definitions and product status are available at: www.st.com. ECOPACK® is an ST trademark.

Figure 5. SOT23-6L dimension definitions

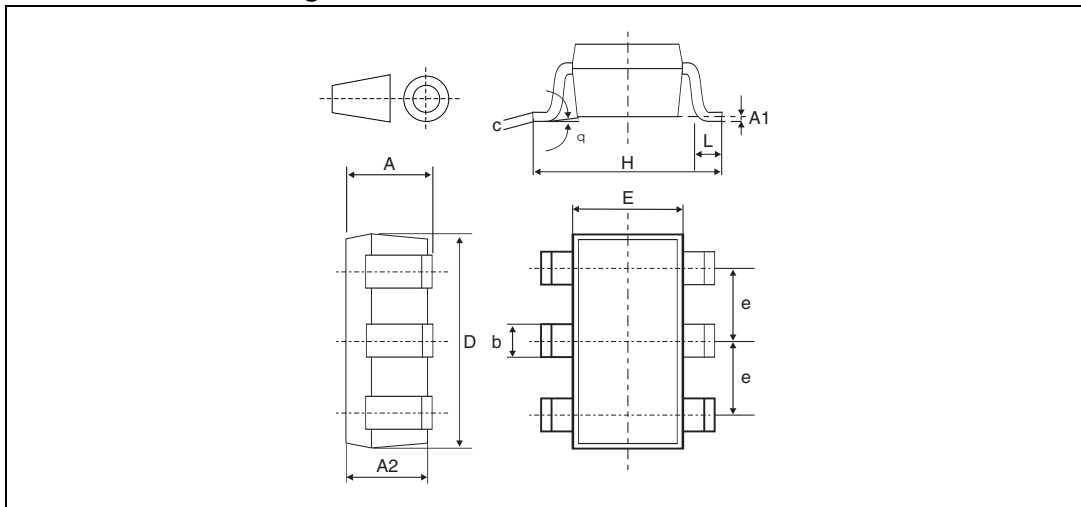

Table 3. SOT23-6L dimension values

Ref.	Dimensions					
	Millimeters			Inches		
	Min.		Max.	Min.		Max.
A	0.90		1.45	0.035		0.057
A1	0		0.10	0		0.004
A2	0.90		1.30	0.035		0.051
b	0.35		0.50	0.014		0.020
c	0.09		0.20	0.004		0.008
D	2.80		3.05	0.11		0.118
E	1.50		1.75	0.059		0.069
e		0.95			0.037	
H	2.60		3.00	0.102		0.118
L	0.10		0.60	0.004		0.024
θ	0°		10°	0°		10°

Figure 6. Footprint recommendations dimensions in mm (inches)

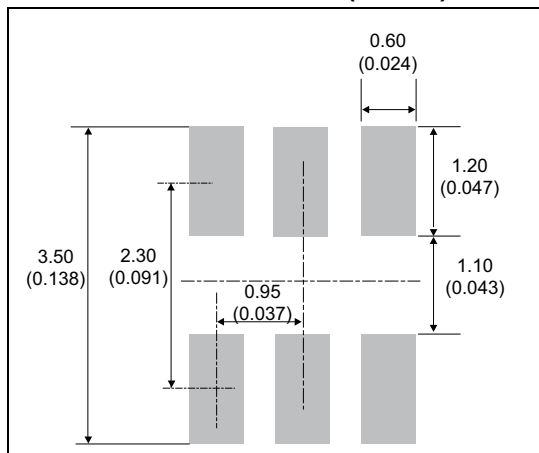
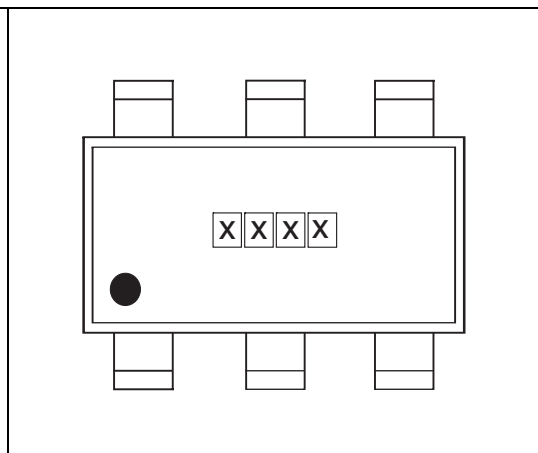

Figure 7. Marking layout



3 Ordering information

Figure 8. Ordering information scheme

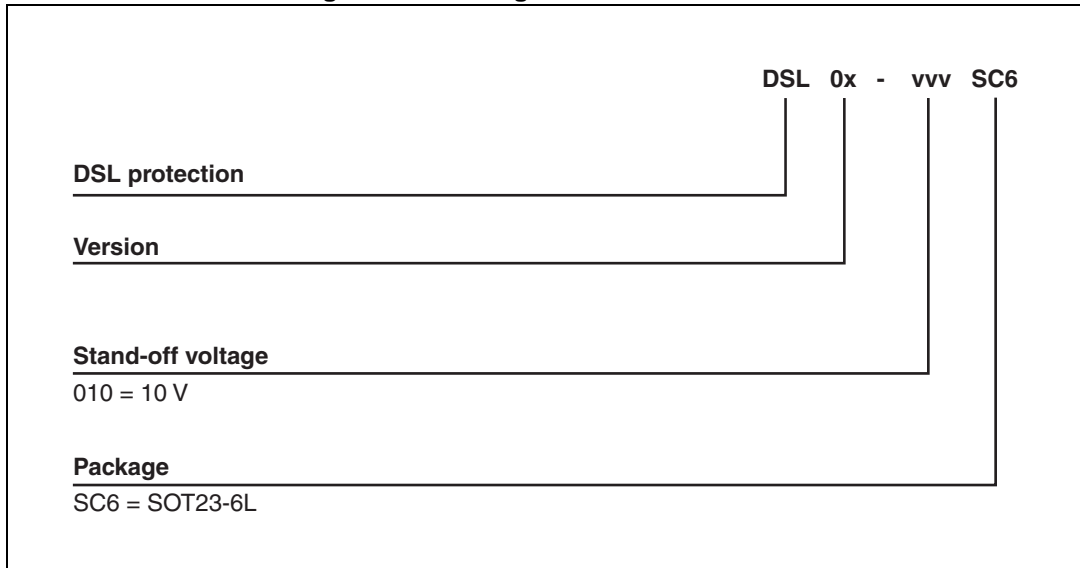

Table 4. Ordering information

Ordering code	Marking	Package	Weight	Base qty	Delivery mode
DSL04-005SC6	DT05	SOT23-6L	14 mg	3000	Tape and reel
DSL04-008SC6	DT08				
DSL04-010SC6	DT10				
DSL04-012SC6	DT12				
DSL04-016SC6	DT16				
DSL04-018SC6	DT18				
DSL04-020SC6	DT20				
DSL04-022SC6	DT22				
DSL04-024SC6	DT24				

4 Revision history

Table 5. Document revision history

Date	Revision	Changes
24-Feb-2012	1	Initial release
03-Feb-2015	2	Reformatted to current standard.

IMPORTANT NOTICE – PLEASE READ CAREFULLY

STMicroelectronics NV and its subsidiaries (“ST”) reserve the right to make changes, corrections, enhancements, modifications, and improvements to ST products and/or to this document at any time without notice. Purchasers should obtain the latest relevant information on ST products before placing orders. ST products are sold pursuant to ST’s terms and conditions of sale in place at the time of order acknowledgement.

Purchasers are solely responsible for the choice, selection, and use of ST products and ST assumes no liability for application assistance or the design of Purchasers’ products.

No license, express or implied, to any intellectual property right is granted by ST herein.

Resale of ST products with provisions different from the information set forth herein shall void any warranty granted by ST for such product.

ST and the ST logo are trademarks of ST. All other product or service names are the property of their respective owners.

Information in this document supersedes and replaces information previously supplied in any prior versions of this document.

© 2015 STMicroelectronics – All rights reserved