



MAX6620 Evaluation Kit/Evaluation System

General Description

The MAX6620 evaluation system (MAX6620EVCMAXQU+) consists of the MAX6620 evaluation kit (MAX6620EVKIT+) and the Maxim CMAXQUSB+ command module. Windows 2000/XP/Vista®-compatible software is also available for use with the MAX6620 evaluation system (EV system) and can be downloaded from the Maxim website (www.maxim-ic.com/evkitsoftware).

The MAX6620 evaluation kit (EV kit) is a fully assembled and tested printed-circuit board (PCB) that evaluates the MAX6620 quad linear fan-speed controller. The MAX6620 controls the speeds of up to four fans using four independent linear voltage outputs. The EV kit includes 3-pin fan headers to allow easy fan connection and an I²C/SMBus™-compatible interface that allows for software control of the drive voltage, tachometer count, fan configuration, and fan dynamics.

The Maxim CMAXQUSB command module provides the I²C/SMBus interface and is connected to the computer through the universal serial bus (USB) port. The MAX6620 EV kit software provides a graphical user interface (GUI) for exercising the MAX6620 features.

Features

- ◆ 3V to 5.5V Supply Voltage Range
- ◆ Controls Up to Four Independent Fans with Linear (DC) Drive
- ◆ Uses Four External Low-Cost PNP Pass Transistors
- ◆ Fan-Fail Output
- ◆ I²C/SMBus-Compatible Interface
- ◆ Fully Assembled and Tested

Ordering Information

PART	TYPE
MAX6620EVKIT+	EV Kit
MAX6620EVCMAXQU+	EV System

+ Denotes lead-free and RoHS-compliant.

Evaluate: MAX6620

Component Lists

MAX6620 EV System

PART	QTY	DESCRIPTION
MAX6620EVKIT+	1	MAX6620 EV kit
CMAXQUSB+	1	I ² C/SMBus interface command module

MAX6620 EV Kit

DESIGNATION	QTY	DESCRIPTION
C1–C6	6	0.1µF ±10%, 16V X7R ceramic capacitors (0603) Murata GRM188R71C104K TDK C1608X7R1C104K
J1	1	2 x 10 right-angle receptacle
J2–J5	4	3-pin headers, 0.1in pitch, vertical, friction lock
JU1	1	2-pin header
JU2–JU6	5	3-pin headers

DESIGNATION	QTY	DESCRIPTION
Q1–Q4	4	20V, 1A, PNP silicon EPI transistors ON Semi BCP69T1G
R1–R4	4	2.7kΩ ±5% resistors (0603)
R5, R6	0	Not installed, resistors (0603)
R7	1	4.7kΩ ±5% resistor (0603)
R8–R11	4	10kΩ ±5% resistors (0603)
U1	1	Quad linear fan-speed controller (28 TQFN-EP*, 5mm x 5mm x 0.8mm) Maxim MAX6620ATI+
Y1	1	Standard 32.768kHz quartz crystal, 12.5pF load capacitance Hong Kong X'tals 3TK0327680D1CF5GX-0A
—	6	Shunts
—	1	PCB: MAX6620 Evaluation Kit+

*EP = Exposed pad.

Windows Vista is a registered trademark of Microsoft Corp.

SMBus is a trademark of Intel Corp.



Maxim Integrated Products 1

For pricing, delivery, and ordering information, please contact Maxim Direct at 1-888-629-4642, or visit Maxim's website at www.maxim-ic.com.

MAX6620 Evaluation Kit/Evaluation System

Component Suppliers

SUPPLIER	PHONE	WEBSITE
Hong Kong X'tals Ltd.	+852-3511-2388	www.hongkongcrystal.com
Murata Mfg. Co., Ltd.	770-436-1300	www.murata.com
ON Semiconductor	602-244-6600	www.onsemi.com
TDK Corp.	847-803-6100	www.component.tdk.com

Note: Indicate that you are using the MAX6620 when contacting these component suppliers.

MAX6620 EV Kit Files

FILE	DESCRIPTION
INSTALL.EXE	Installs the EV kit files on your computer
MAX6620.EXE	Application program
TROUBLESHOOTING_USB.PDF	USB driver installation help file
FTD2XX.INF	USB driver file
UNINST.INI	Uninstalls the EV kit software

Quick Start

Recommended Equipment

Before beginning, the following equipment is needed:

- User-supplied PC running Windows 2000/XP/Vista
- Available USB port
- 5V/2A or 12V/2A DC power supply (VFAN)
- One to four brushless DC fans
- MAX6620 EV system
 - MAX6620 EV kit
 - CMAXQUSB+ command module (USB cable included)

Note: In the following sections, software-related items are identified by bolding. Text in **bold** refers to items directly from the EV kit software. Text in **bold and underlined** refers to items from the Windows 2000/XP/Vista operating system.

Procedure

The MAX6620 EV kit is fully assembled and tested. Follow the steps to verify board operation. **Caution: Do not turn on the power supply until all connections are completed.**

- 1) On the CMAXQUSB command module, ensure that the shunt on jumper JU1 is in the 3.3V position.
- 2) To enable the on-board VCC supply, ensure that a shunt is installed between pins 2-3 on jumper JU2 on the MAX6620 EV kit. Also, verify that the shunt on JU1 of the EV kit is uninstalled.
- 3) Carefully connect the boards by aligning the 20-pin connector of the MAX6620EV kit with the 20-pin header on the CMAXQUSB interface board. Gently press them together.
- 4) Connect one to four fans appropriately. **Note:** The EV kit is configured for use with fans that typically draw up to 400mA. When using larger fans, a different pass transistor might be required for proper operation.
- 5) With power off, connect the positive terminal of the DC power supply to the VFAN pad, and the ground terminal to the FAN_GND pad next to VFAN.
- 6) Connect the USB cable from the computer's type-A USB port to the CMAXQUSB board's type-B USB port.
- 7) Visit www.maxim-ic.com/evkitsoftware to download the latest version of the MAX6620 EV kit software and install it on your computer by running the INSTALL.EXE program. The program files are copied and icons are created in the Windows **Start** menu.
- 8) Turn on the power supply and set it to 5V or 12V, as appropriate.
- 9) Start the MAX6620 program by opening its icon in the **Start** menu.
- 10) Normal device operation is verified when **C Maxwell HW: Connected. MAX6620 device connected.** is displayed at the bottom left of the MAX6620 EV kit main window (Figure 1).

MAX6620 Evaluation Kit/Evaluation System

Detailed Description of Software

User-Interface Panel

The program's main window contains two tabs, **Fan Status** and **Fan Configuration/Dynamics**, which provide controls for the MAX6620 EV kit software's configurable features. The **Fan Status** tab sheet (Figure 1) provides controls for the **Global Configuration** register, **TACH Count**, **Drive Voltage**, **Targets**, and **Faults**. The **Fan Configuration/Dynamics** tab sheet (Figure 2) provides controls for **Fan Configuration** and **Fan Dynamics**. A status box is also provided at the bottom of the program's main window and is used to verify command module and device connectivity.

VFAN Input Setting (5V or 12V)

The MAX6620 EV kit software can be configured to work with 5V or 12V DC fans. Manually select the appropriate fan voltage from the **VFAN** drop-down list (Figure 1). The default setting is for use with 12V DC fans.

Global Configuration

The **Global Configuration** group box contains several functions that control general operation. The **I2C Bus Timeout** checkbox resets the interface if SDA is low for more than 35ms, when enabled. The **Fans to 100% on Failure** checkbox, when checked, drives the fans to full-scale drive voltage when a fan failure is detected. The **External Xtal** checkbox toggles between the internal oscillator (unchecked) and the 32.768 kHz on-board crystal (checked).

Evaluate: MAX6620

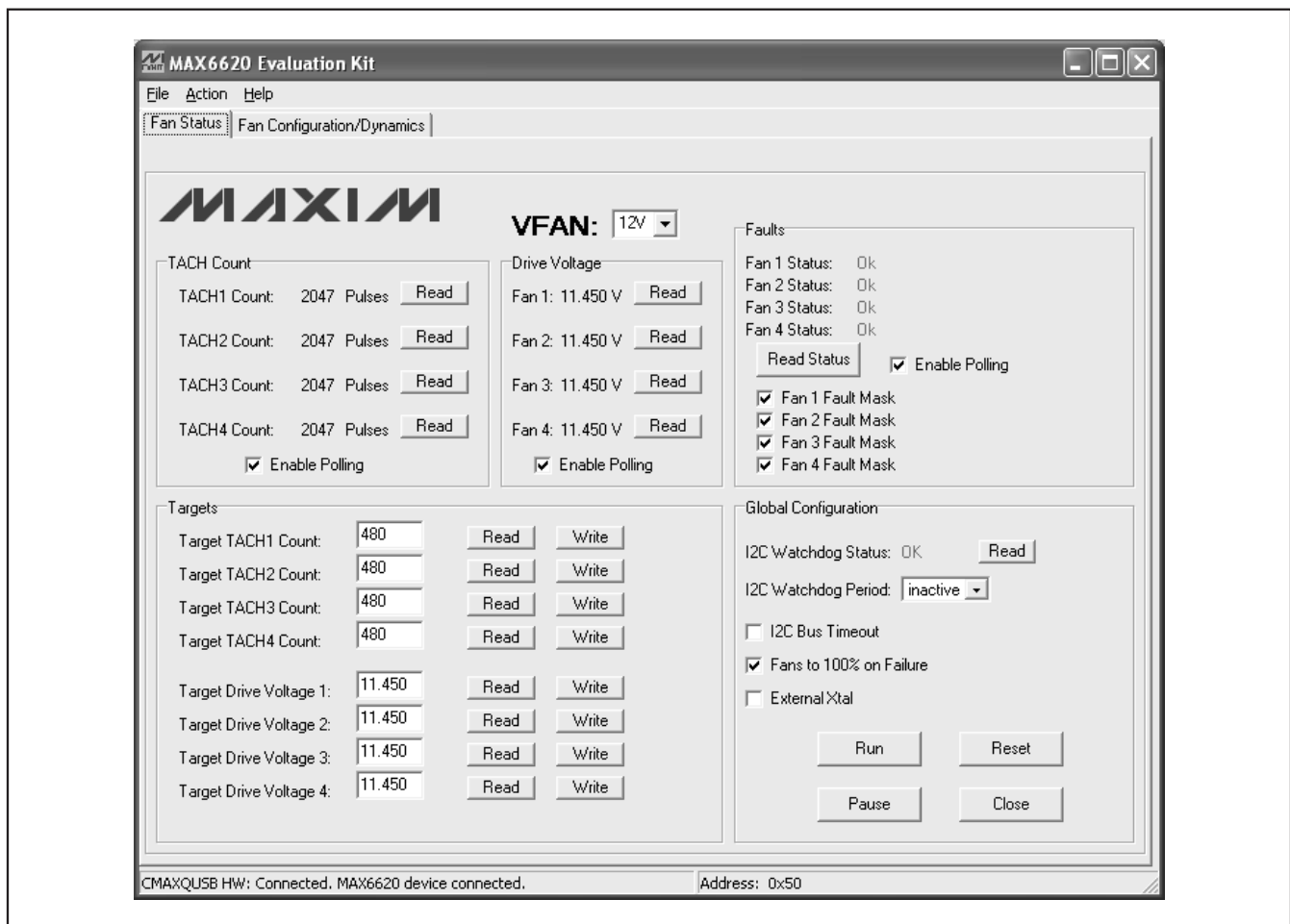

Figure 1. MAX6620 EV Kit Software—Fan Status Tab

MAX6620 Evaluation Kit/Evaluation System

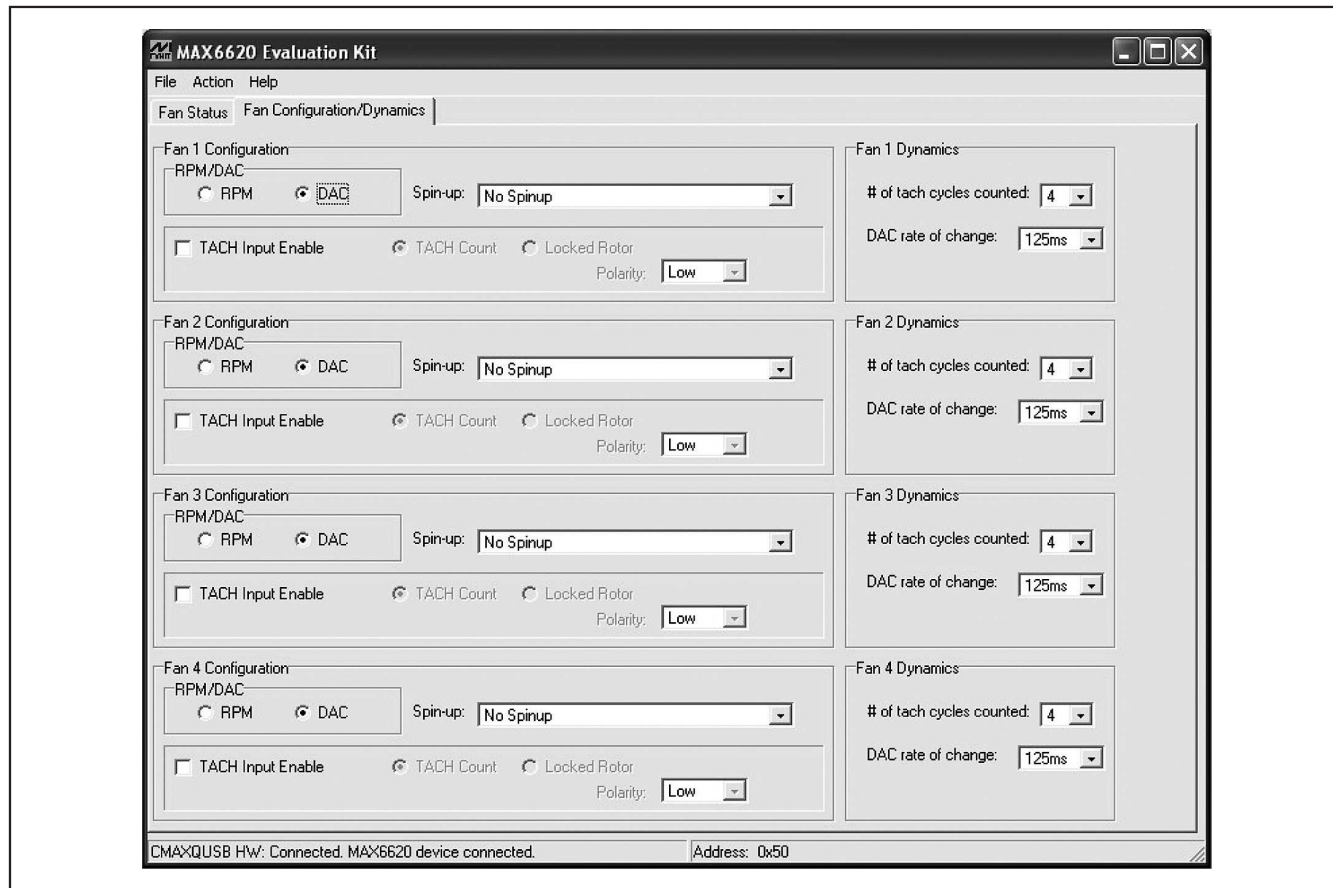

Figure 2. MAX6620 EV Kit Software—Fan Configuration/Dynamics Tab

I2C Watchdog

The **I2C Watchdog Period** drop-down list controls the period that the watchdog monitors SDA and SCL for valid I²C transactions. If there are no valid transactions between the master and the MAX6620 within the watchdog period, all fan output voltages go to full-scale drive voltage. The **I2C Watchdog Status** indicator monitors whether a watchdog fault has occurred. This bit is cleared when read.

TACH Count and Drive Voltage

With polling enabled, the **TACH Count** group box automatically reads the tachometer count for each corresponding fan. With polling disabled, press the **Read** buttons next to each fan's **TACH_Count** label.

With polling enabled, the **Drive Voltage** group box automatically reads the drive voltage for each corresponding fan. With polling disabled, press the **Read** buttons next to each fan's drive voltage label. When a fan is driven at full-scale voltage, the drive voltage label text is displayed in red font.

MAX6620 Evaluation Kit/Evaluation System

Targets

In RPM mode, the **Target TACH_Count** sets the desired tachometer count for each corresponding fan. The MAX6620 then adjusts the fan drive voltage to achieve this tachometer count. In DAC mode, this feature has no effect.

In DAC mode, write the desired fan drive voltage to the **Target Drive Voltage_** edit box. The MAX6620 then drives the fan with this voltage.

Faults

Fan_Status

Fan faults are detected through the fan fault register and displayed in the **Faults** group box. When a fault is detected, the **Fan_Status** label changes from **Ok** to **Fault** and displays the text in red font. Since these bits latch until they are cleared by reading, the option to poll bits automatically, or manually read status, is offered by toggling the **Enable Polling** checkbox. Refer to the MAX6620 IC data sheet for more information regarding types of faults.

Fan_Fault Mask

The **Fan_Fault Mask** checkboxes give the option to mask faults on selected fans from asserting the **FAN_FAIL** hardware option. When checked, bits do not assert the **FAN_FAIL** output. Faults are still indicated through **Fan_Status**.

Fan_Configuration

The **Fan_Configuration** group boxes (Figure 2) configure the corresponding fan's **Spin-up** conditions, **TACH Input Enable** settings, and set either RPM or DAC mode.

RPM/DAC Mode

Select the appropriate **RPM** or **DAC** radio button to set the fan to either RPM or DAC mode. In RPM mode, the fan drive voltage is adjusted to produce the tachometer count value in the **Fan_Target TACH Count** register. In DAC mode, the fan drive voltage is set by the value in the **Fan_Target Drive Voltage** register.

Spin-up

The **Spin-up** drop-down list controls the period of time that the fan is driven at full-scale voltage before reducing the drive to the selected value. The default is set through jumper JU6.

TACH Settings

The **TACH Input Enable** checkboxes enable the TACH input function and fan-fault detection. When enabled, select the appropriate radio button to set the TACH input to either **TACH Count** or **Locked Rotor**. When using locked rotor input, the **Polarity** can be set at high or low.

Fan_Dynamics

The **Fan_Dynamics** group box contains controls for individual fan speed range and DAC rate-of-change. The **# of tach cycles counted** drop-down list sets the number of complete tachometer cycles used for counting the number of 8192Hz clock cycles. For example, by default, this number is set to 4, which means that the MAX6620 counts the number of 8192Hz clock cycles in four complete tachometer cycles.

The **DAC rate of change** drop-down list determines the time interval between output voltage increments. Note that in RPM mode, a setting of zero would result in an unstable feedback loop, so a default of 0.0625 is in effect when zero is selected.

MAX6620 Evaluation Kit/Evaluation System

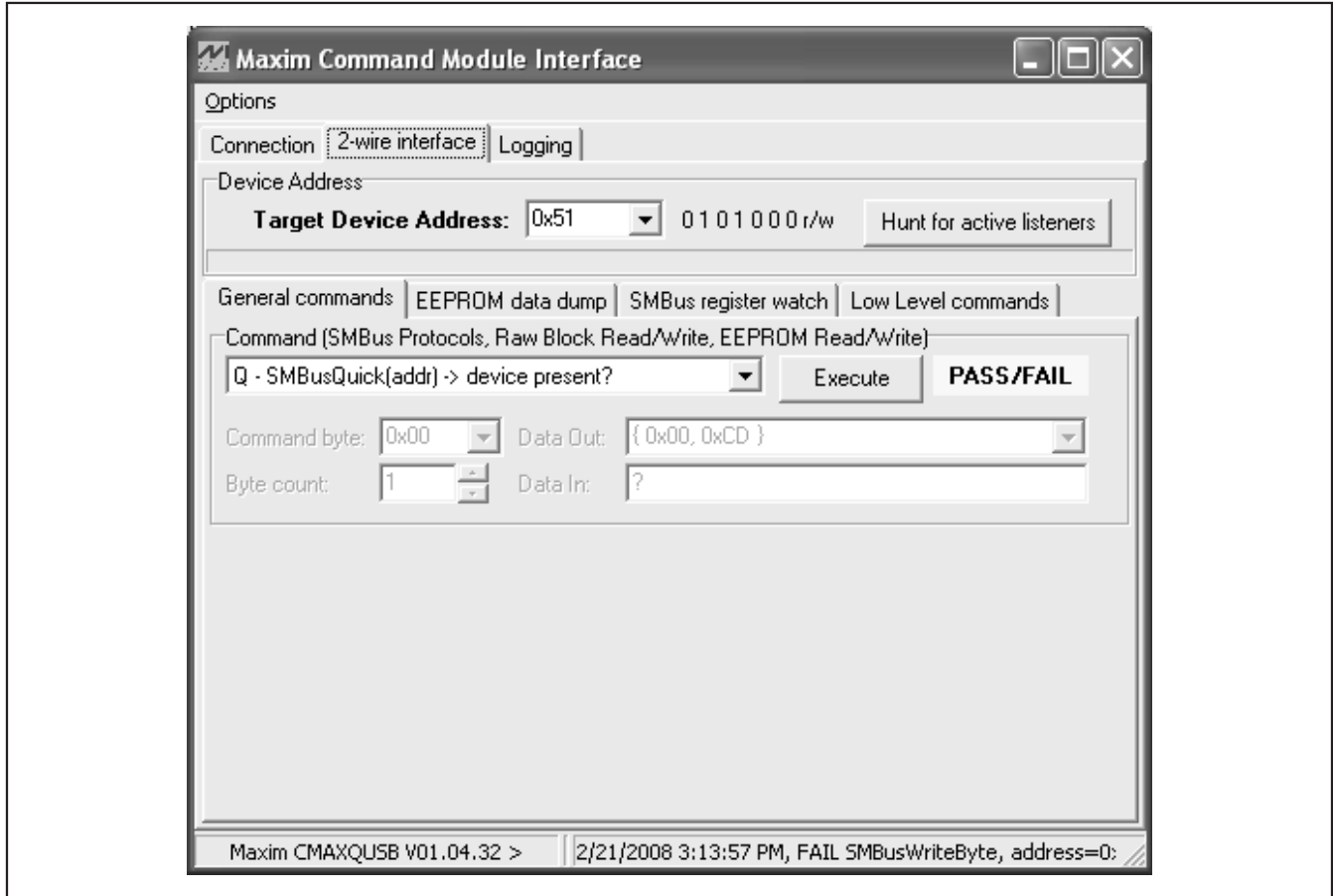

Figure 3. Interface Diagnostic Window

Simple I²C/SMBus Commands

There are two methods for communicating with the MAX6620, through the normal user-interface panel (Figures 1 and 2), or through the SMBus commands available by selecting the **Interface Diagnostic Window** menu item from the **Action** menu bar. The **Maxim Command Module Interface** window pops up and includes a **2-wire interface** tab that allows for execution of the **SMBusSendByte()** and **SMBusQuick()** commands.

The SMBus dialog boxes accept numeric data in binary, decimal, or hexadecimal. Hexadecimal numbers should be prefixed by \$ or 0x. Binary numbers must be exactly eight digits. See Figure 3 for an illustration of this tool.

Detailed Description of Hardware

Jumper Settings

Several jumper settings in the following tables illustrate features of the MAX6620 EV kit.

Oscillator Selection

The MAX6620 EV kit gives the option to use the MAX6620's internal oscillator or external on-board 32.768kHz quartz crystal (see Table 1). By default, the chip's internal oscillator is used. For increased accuracy, an external 32.768kHz quartz crystal can be applied by installing jumper JU1.

Table 1. Jumper JU1 Functions

SHUNT POSITION	X1 PIN	OSCILLATOR
Installed	Connected to X2 through Y1	External 32.768kHz quartz crystal
Not installed*	Open	Internal oscillator used

*Default position.

MAX6620 Evaluation Kit/Evaluation System

VCC Power Supply

The MAX6620 gives the option to power VCC through the CMAXQUSB module or through an external supply. This can be accomplished through setting jumper JU2 (see Table 2). By default, the MAX6620's VCC supply is powered through the CMAXQUSB module, eliminating the need for an external VCC supply.

Table 2. Jumper JU2 Functions

SHUNT POSITION	VCC PIN
1-2	External 3.0V to 5.5V supply required
2-3*	Powered from CMAXQUSB module

*Default position.

I²C Slave Address Selection

The MAX6620 is programmable to one of three I²C slave addresses through jumper JU3 (see Table 3). The address is defined as the 7 most significant bits (MSBs) followed by the read/write bit.

Table 3. Jumper JU3 Functions

SHUNT POSITION	ADD PIN	ADDRESS
1-2	Connected to VCC	0x54
Not installed	Open	0x52
2-3*	Connected to GND	0x50

*Default position.

I²C Watchdog (WD) Startup Conditions

The MAX6620 I²C watchdog function (see Table 4) monitors SDA and SCL when enabled at startup by configuring jumper JU4. When this feature is enabled and 10s elapse without a valid I²C transaction, the fan drive goes to 100%. The watchdog function is disabled by default.

Table 4. Jumper JU4 Functions

SHUNT POSITION	WD_START PIN	WD FUNCTION
1-2	Connected to VCC	Enabled
2-3*	Connected to GND	Disabled

*Default position.

DAC Startup Conditions

The MAX6620 samples the DAC_START input when power is first applied and sets the power-up value for the fan drive voltage based on jumper JU5 configuration. By default, the DAC_START pin is connected to VCC, setting the initial fan drive voltage to VFAN.

Table 5. Jumper JU5 Functions

SHUNT POSITION	DAC_START PIN	INITIAL FAN DRIVE VOLTAGE
1-2*	Connected to VCC	VFAN
Not installed	Open	0.75 x VFAN
2-3	Connected to GND	0V

*Default position.

Initial Spin-Up Behavior

The initial spin-up behavior of the MAX6620 is sampled at the input of SPIN_START when power is first applied. Initial spin-up behavior can be set through jumper JU6 at power-up (see Table 6 for spin-up configuration). It is also possible to modify spin-up behavior by writing appropriate settings to the MAX6620's registers. By default, the initial spin-up feature is disabled.

Table 6. Jumper JU6 Functions

SHUNT POSITION	SPIN_START PIN	INITIAL SPIN-UP BEHAVIOR
1-2	Connected to VCC	Full-scale drive voltage until two tachometer pulses, or 1s has elapsed
Not installed	Open	Full-scale drive voltage until two tachometer pulses, or 0.5s has elapsed
2-3*	Connected to GND	Spin-up disabled

*Default position.

MAX6620 Evaluation Kit/Evaluation System

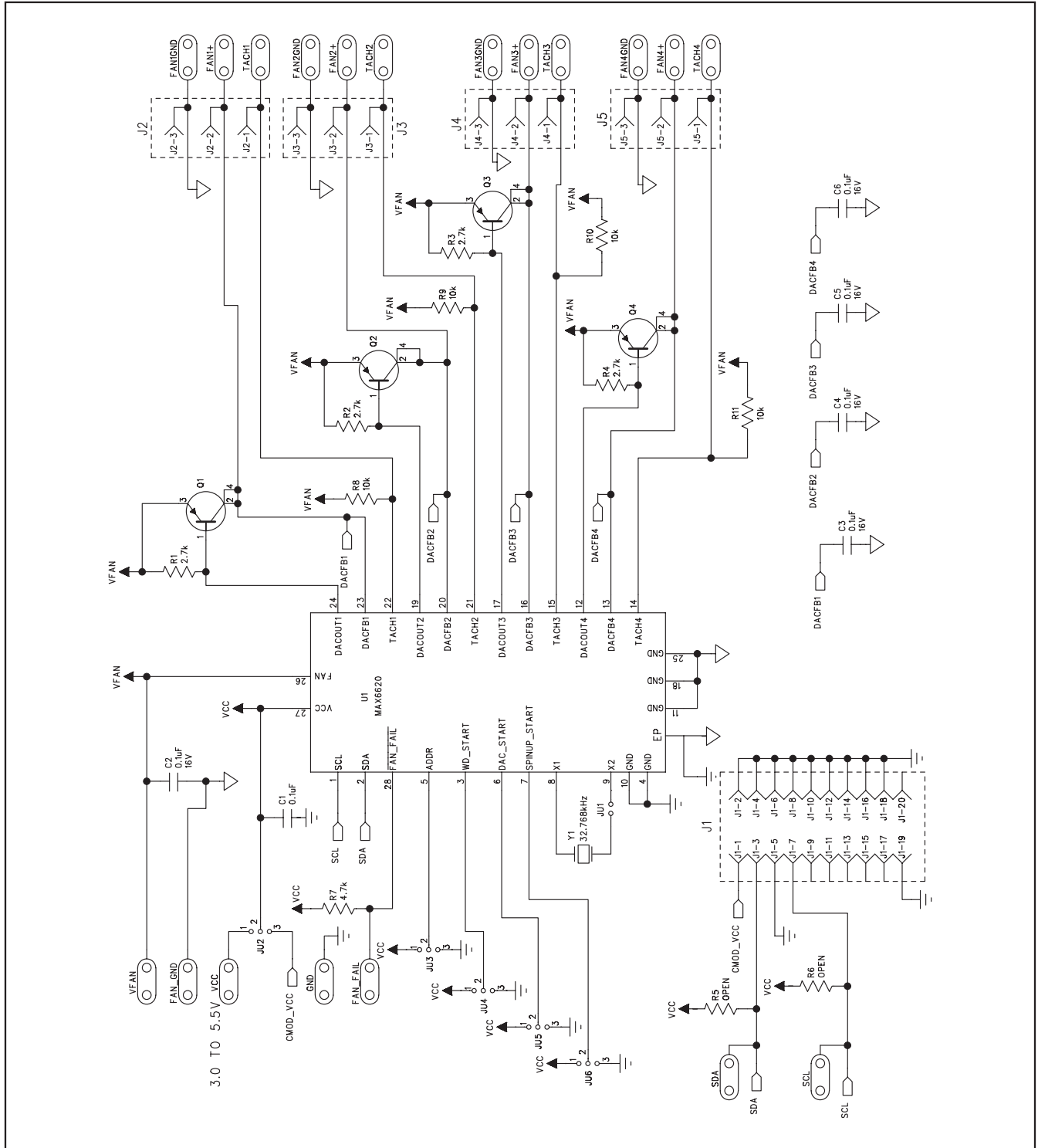

Figure 4. MAX6620 EV Kit Schematic

MAX6620 Evaluation Kit/Evaluation System

Evaluate: MAX6620

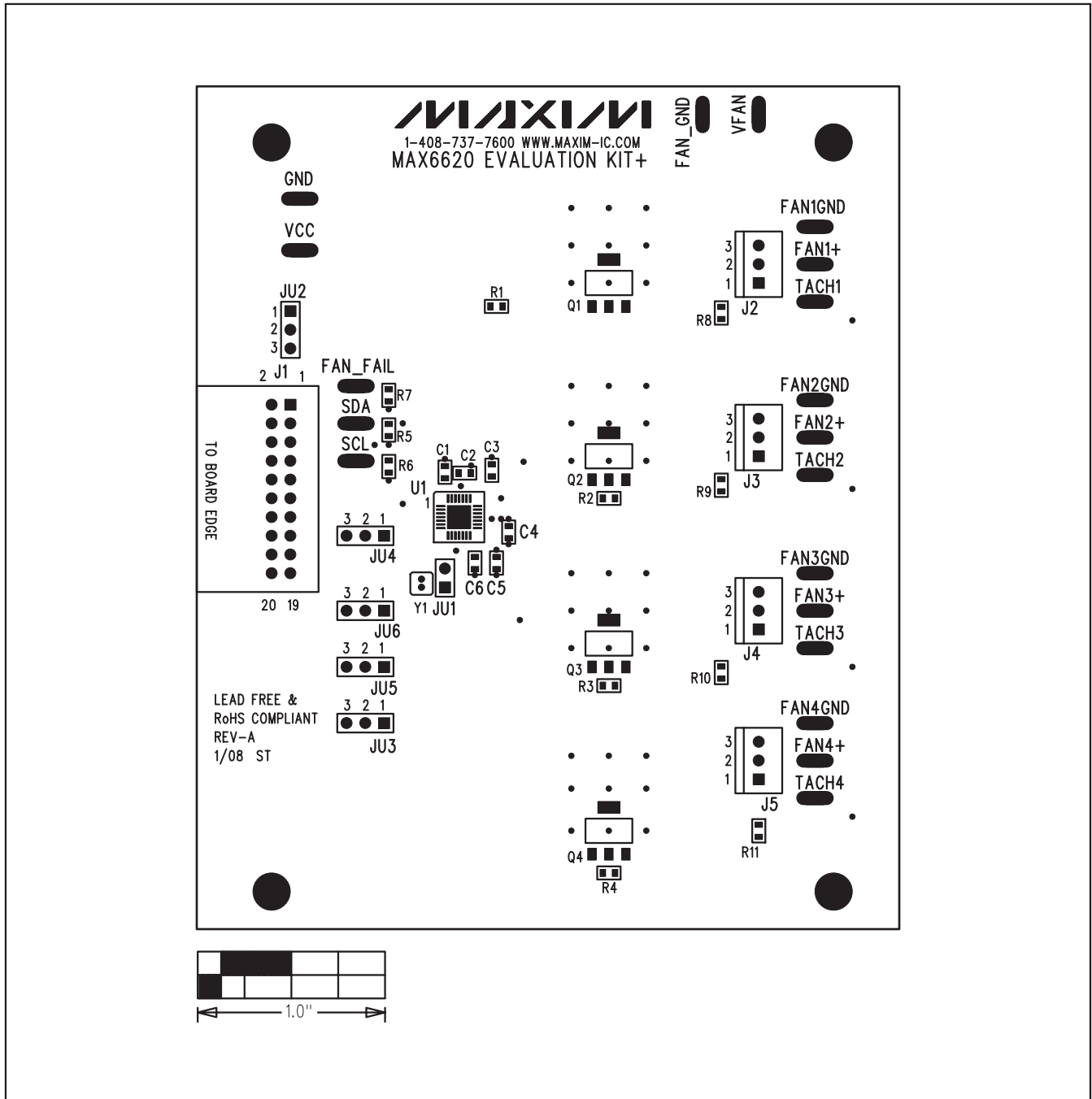

Figure 5. MAX6620 EV Kit Component Placement Guide—Component Side

MAX6620 Evaluation Kit/Evaluation System

Evaluate: MAX6620

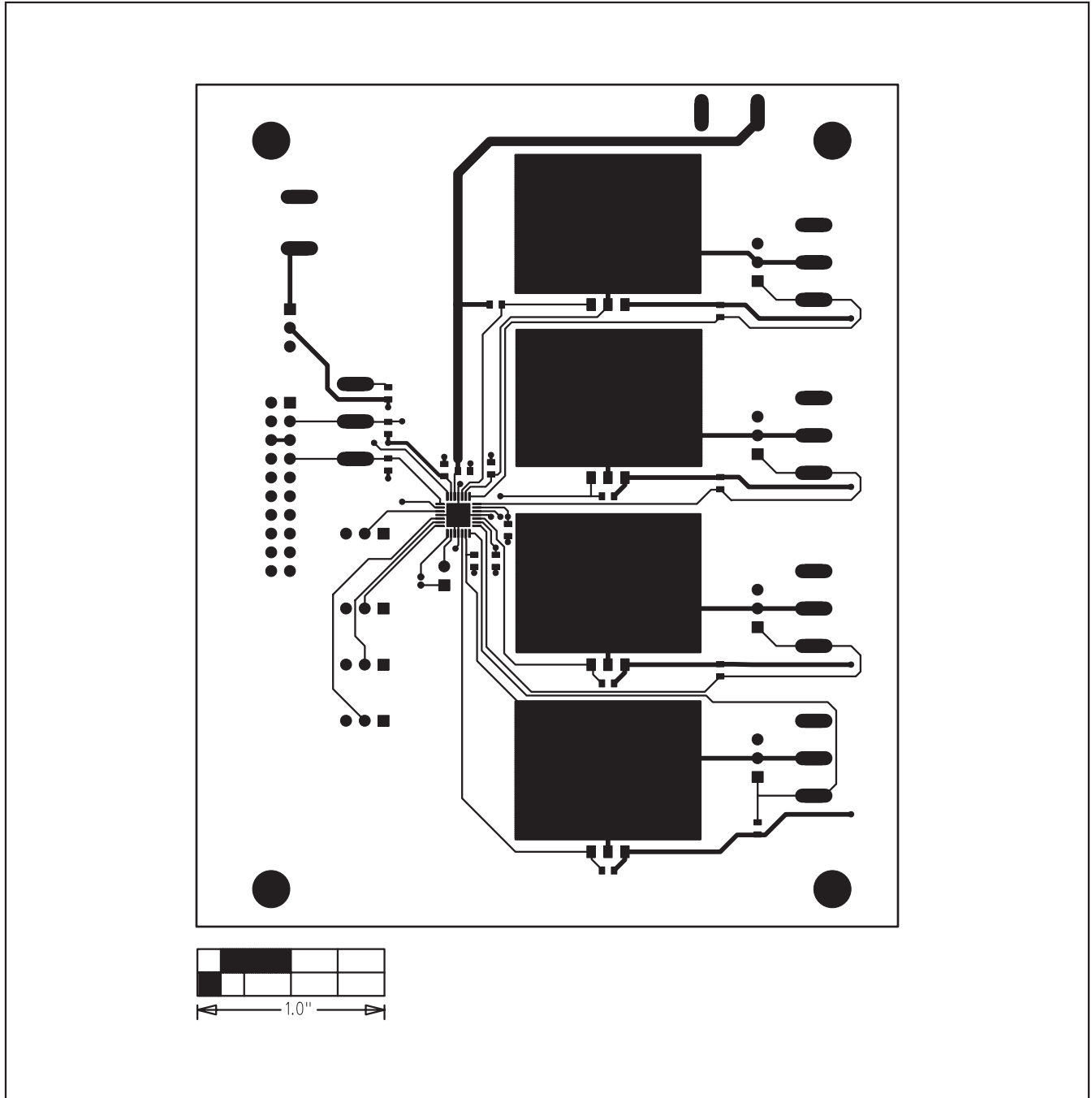

Figure 6. MAX6620 EV Kit PCB Layout—Component Side

MAX6620 Evaluation Kit/Evaluation System

Evaluate: MAX6620

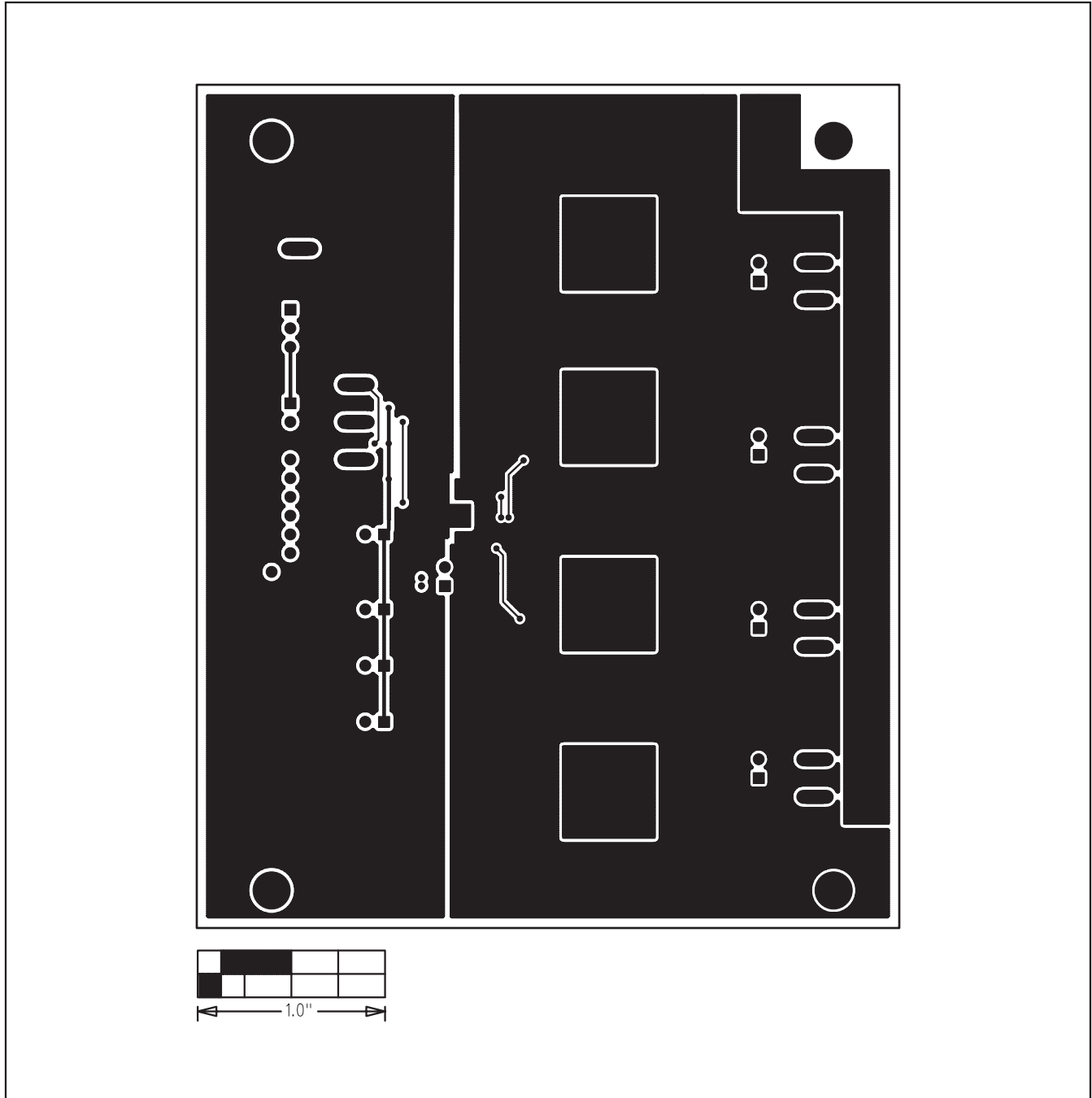

Figure 7. MAX6620 EV Kit PCB Layout—Solder Side

Maxim cannot assume responsibility for use of any circuitry other than circuitry entirely embodied in a Maxim product. No circuit patent licenses are implied. Maxim reserves the right to change the circuitry and specifications without notice at any time.

Maxim Integrated Products, 120 San Gabriel Drive, Sunnyvale, CA 94086 408-737-7600 _____ 11

© 2008 Maxim Integrated Products

MAXIM is a registered trademark of Maxim Integrated Products, Inc.