

NJW21193G (PNP) NJW21194G (NPN)

Silicon Power Transistors

The NJW21193G and NJW21194G utilize Perforated Emitter technology and are specifically designed for high power audio output, disk head positioners and linear applications.

Features

- Total Harmonic Distortion Characterized
- High DC Current Gain
- Excellent Gain Linearity
- High SOA
- These Devices are Pb-Free and are RoHS Compliant

MAXIMUM RATINGS

Rating	Symbol	Value	Unit
Collector-Emitter Voltage	V_{CEO}	250	Vdc
Collector-Base Voltage	V_{CBO}	400	Vdc
Emitter-Base Voltage	V_{EBO}	5.0	Vdc
Collector-Emitter Voltage - 1.5 V	V_{CEX}	400	Vdc
Collector Current - Continuous	I_C	16	Adc
Collector Current - Peak (Note 1)	I_{CM}	30	Adc
Base Current - Continuous	I_B	5.0	Adc
Total Power Dissipation @ $T_C = 25^\circ\text{C}$ Derate Above 25°C	P_D	200 1.6	W W/ $^\circ\text{C}$
Operating and Storage Junction Temperature Range	T_J, T_{stg}	- 65 to +150	$^\circ\text{C}$

Stresses exceeding Maximum Ratings may damage the device. Maximum Ratings are stress ratings only. Functional operation above the Recommended Operating Conditions is not implied. Extended exposure to stresses above the Recommended Operating Conditions may affect device reliability.

1. Pulse Test: Pulse Width = 5 μs , Duty Cycle $\leq 10\%$.

THERMAL CHARACTERISTICS

Characteristic	Symbol	Max	Unit
Thermal Resistance, Junction-to-Case	$R_{\theta JC}$	0.625	$^\circ\text{C}/\text{W}$
Thermal Resistance, Junction-to-Ambient	$R_{\theta JA}$	40	$^\circ\text{C}/\text{W}$



ON Semiconductor®

<http://onsemi.com>

16 AMPERES COMPLEMENTARY SILICON POWER TRANSISTORS 250 VOLTS, 200 WATTS

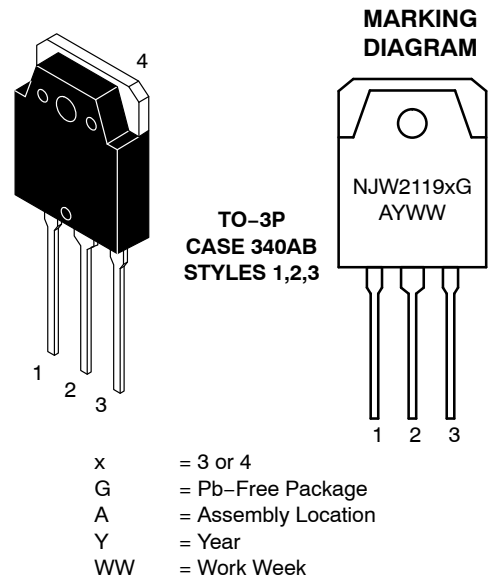
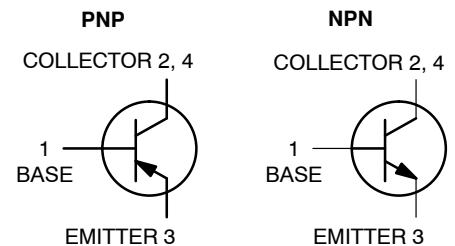

ORDERING INFORMATION

Device	Package	Shipping
NJW21193G	TO-3P (Pb-Free)	30 Units/Rail
NJW21194G	TO-3P (Pb-Free)	30 Units/Rail

NJW21193G (PNP) NJW21194G (NPN)

ELECTRICAL CHARACTERISTICS (T_C = 25°C unless otherwise noted)

Characteristic	Symbol	Min	Typ	Max	Unit
----------------	--------	-----	-----	-----	------

OFF CHARACTERISTICS

Collector–Emitter Sustaining Voltage (I _C = 100 mA _{dc} , I _B = 0)	V _{CEO(sus)}	250	–	–	V _{dc}
Collector Cutoff Current (V _{CE} = 200 V _{dc} , I _B = 0)	I _{CEO}	–	–	100	μA _{dc}
Emitter Cutoff Current (V _{CE} = 5 V _{dc} , I _C = 0)	I _{EBO}	–	–	100	μA _{dc}
Collector Cutoff Current (V _{CE} = 250 V _{dc} , V _{BE(off)} = 1.5 V _{dc})	I _{CEX}	–	–	100	μA _{dc}

SECOND BREAKDOWN

Second Breakdown Collector Current with Base Forward Biased (V _{CE} = 50 V _{dc} , t = 1 s (non-repetitive)) (V _{CE} = 80 V _{dc} , t = 1 s (non-repetitive))	I _{S/b}	4.0 2.25	– –	– –	A _{dc}
---	------------------	-------------	--------	--------	-----------------

ON CHARACTERISTICS

DC Current Gain (I _C = 8 A _{dc} , V _{CE} = 5 V _{dc}) (I _C = 16 A _{dc} , I _B = 5 A _{dc})	h _{FE}	20 8	– –	80 –	
Base–Emitter On Voltage (I _C = 8 A _{dc} , V _{CE} = 5 V _{dc})	V _{BE(on)}	–	–	2.2	V _{dc}
Collector–Emitter Saturation Voltage (I _C = 8 A _{dc} , I _B = 0.8 A _{dc}) (I _C = 16 A _{dc} , I _B = 3.2 A _{dc})	V _{CE(sat)}	– –	– –	1.4 4	V _{dc}

DYNAMIC CHARACTERISTICS

Total Harmonic Distortion at the Output V _{RMS} = 28.3 V, f = 1 kHz, P _{LOAD} = 100 W _{RMS} (Matched pair h _{FE} = 50 @ 5 A/5 V)	h _{FE} unmatched h _{FE} matched	T _{HD}	– –	0.8 0.08	– –	%
Current Gain Bandwidth Product (I _C = 1 A _{dc} , V _{CE} = 10 V _{dc} , f _{test} = 1 MHz)	f _T	4	–	–	–	MHz
Output Capacitance (V _{CB} = 10 V _{dc} , I _E = 0, f _{test} = 1 MHz)	C _{ob}	–	–	500	–	pF

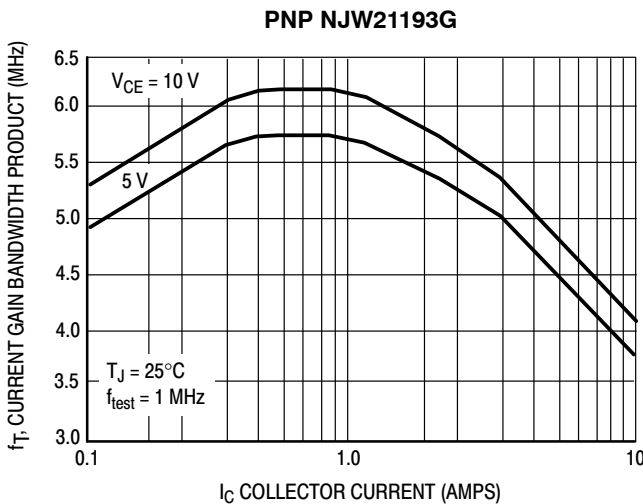

Figure 1. Typical Current Gain Bandwidth Product

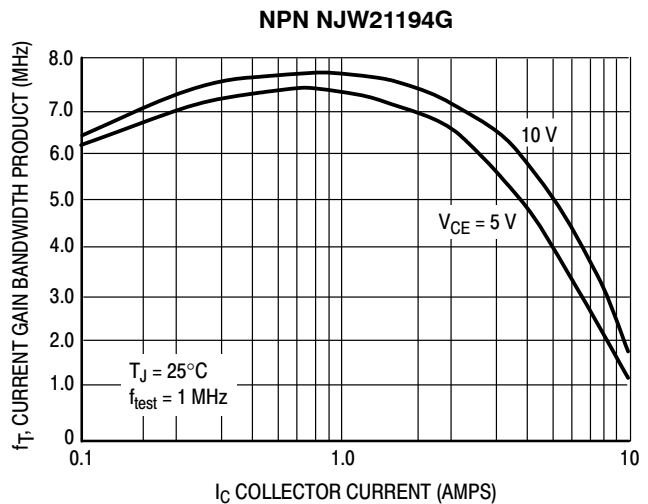

Figure 2. Typical Current Gain Bandwidth Product

NJW21193G (PNP) NJW21194G (NPN)

TYPICAL CHARACTERISTICS

PNP NJW21193G

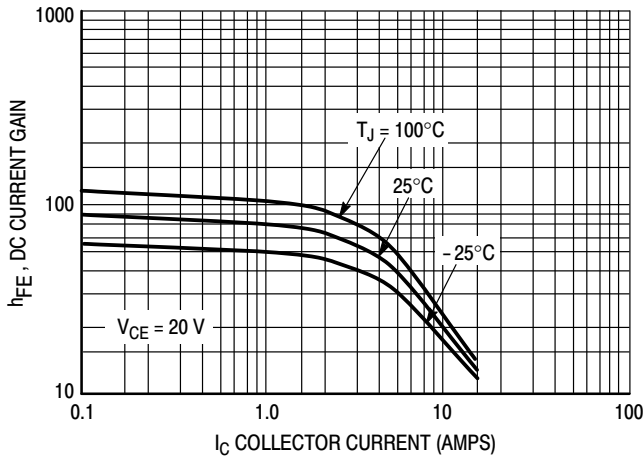

Figure 3. DC Current Gain, $V_{CE} = 20\text{ V}$

NPN NJW21194G

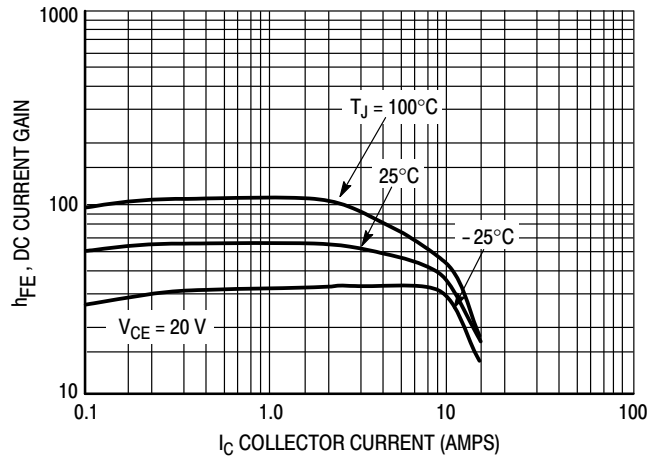

Figure 4. DC Current Gain, $V_{CE} = 20\text{ V}$

PNP NJW21193G

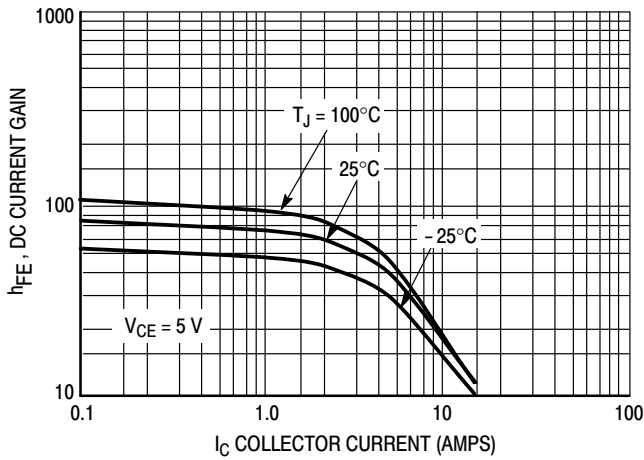

Figure 5. DC Current Gain, $V_{CE} = 5\text{ V}$

NPN NJW21194G

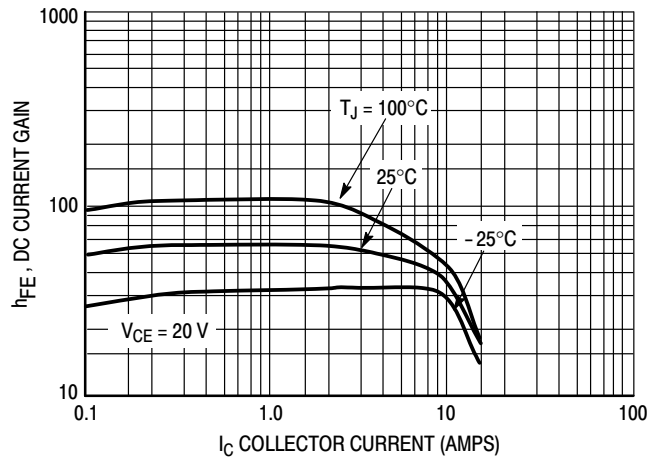

Figure 6. DC Current Gain, $V_{CE} = 5\text{ V}$

PNP NJW21193G

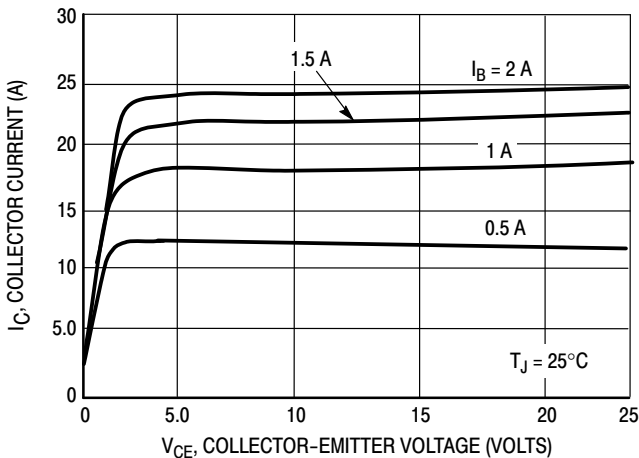

Figure 7. Typical Output Characteristics

NPN NJW21194G

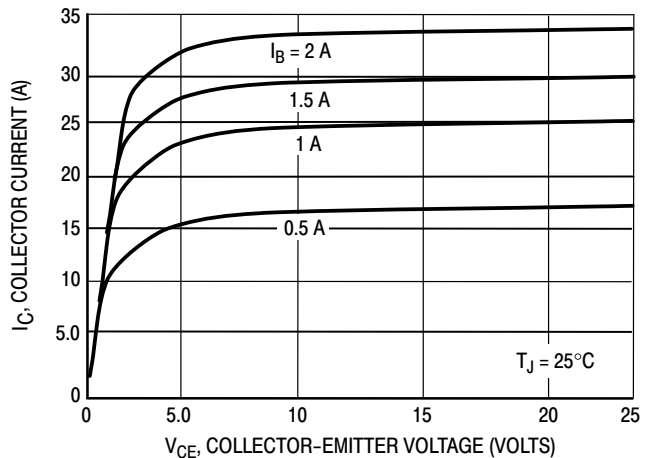

Figure 8. Typical Output Characteristics

NJW21193G (PNP) NJW21194G (NPN)

TYPICAL CHARACTERISTICS

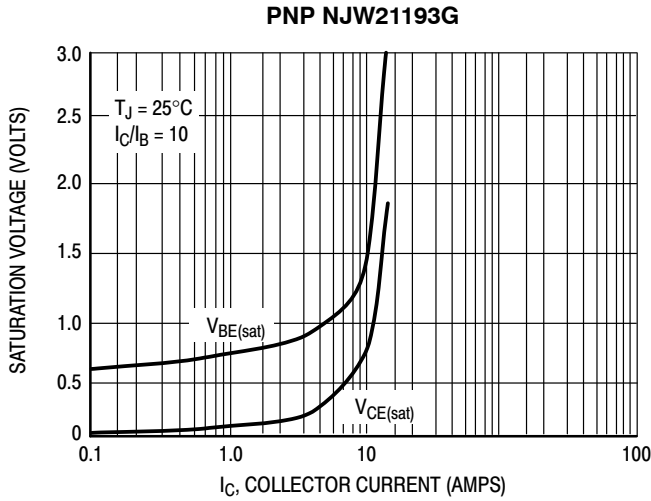

Figure 9. Typical Saturation Voltages

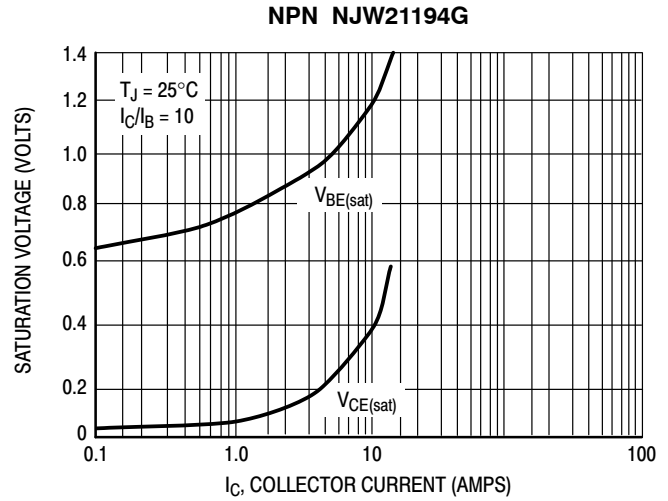

Figure 10. Typical Saturation Voltages

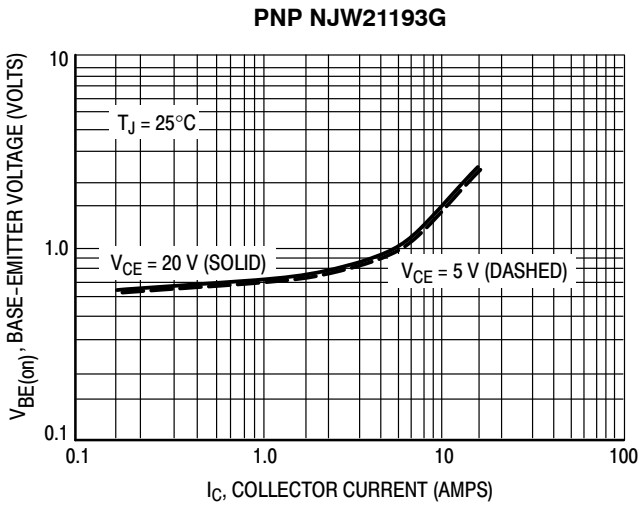

Figure 11. Typical Base-Emitter Voltage

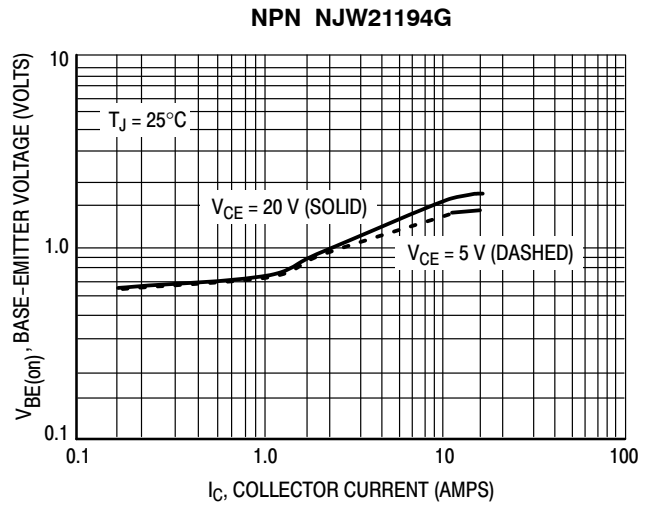

Figure 12. Typical Base-Emitter Voltage

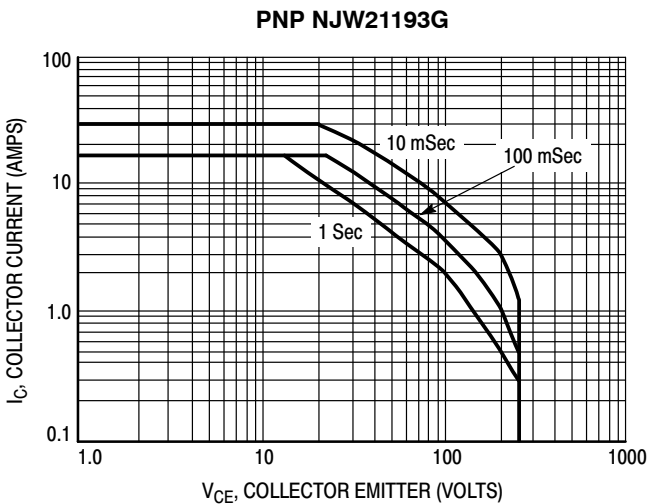

Figure 13. Active Region Safe Operating Area

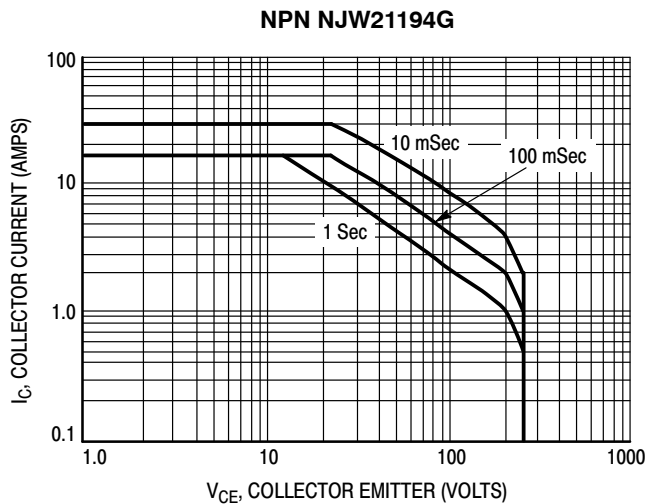

Figure 14. Active Region Safe Operating Area

NJW21193G (PNP) NJW21194G (NPN)

There are two limitations on the power handling ability of a transistor; average junction temperature and secondary breakdown. Safe operating area curves indicate $I_C - V_{CE}$ limits of the transistor that must be observed for reliable operation; i.e., the transistor must not be subjected to greater dissipation than the curves indicate.

The data of Figure 13 is based on $T_{J(pk)} = 150^\circ\text{C}$; T_C is variable depending on conditions. At high case temperatures, thermal limitations will reduce the power than can be handled to values less than the limitations imposed by second breakdown.

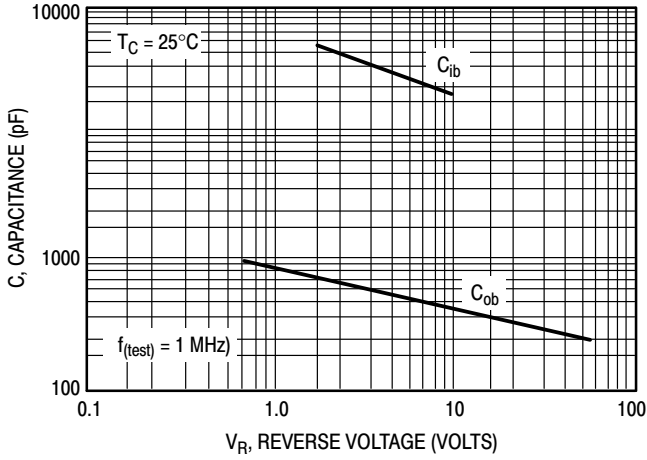

Figure 15. NJW21193G Typical Capacitance

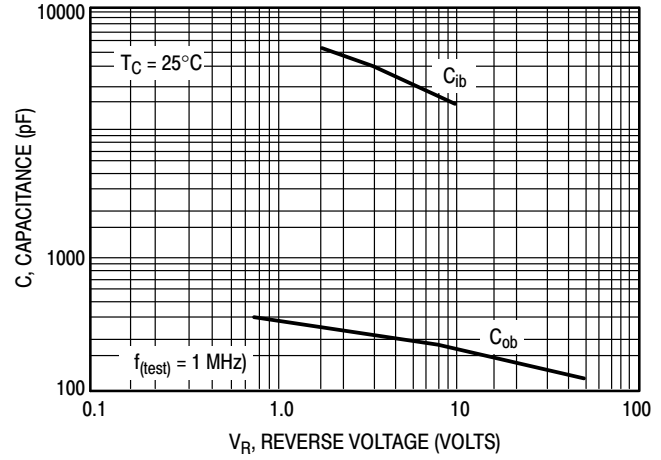

Figure 16. NJW21194G Typical Capacitance

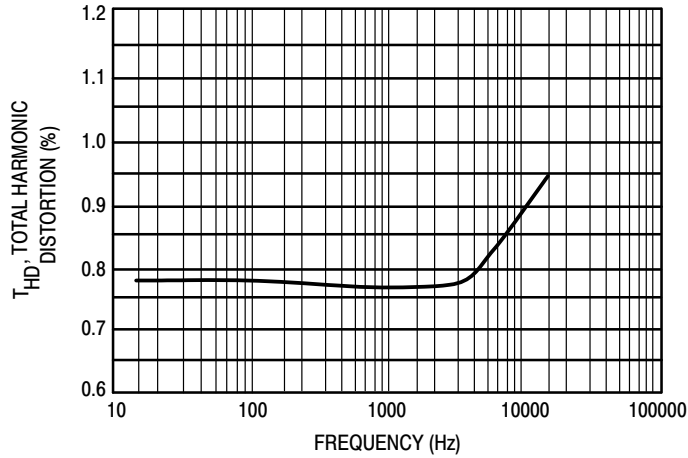

Figure 17. Typical Total Harmonic Distortion

NJW21193G (PNP) NJW21194G (NPN)

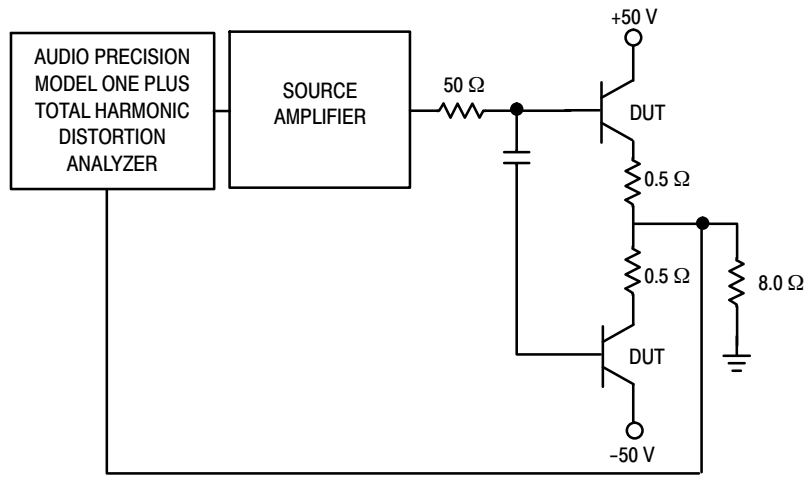
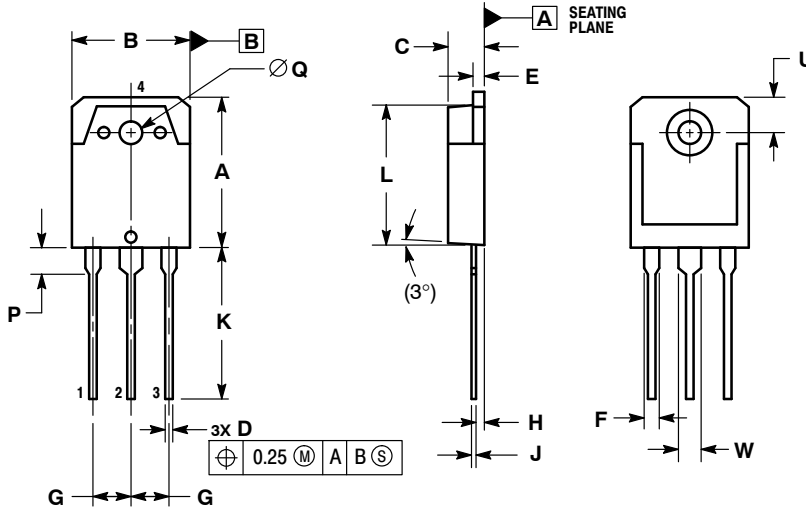

Figure 18. Total Harmonic Distortion Test Circuit

NJW21193G (PNP) NJW21194G (NPN)

PACKAGE DIMENSIONS

TO-3P-3LD
CASE 340AB-01
ISSUE A



NOTES:

1. DIMENSIONING AND TOLERANCING PER ASME Y14.5M, 1994.
2. CONTROLLING DIMENSION: MILLIMETERS
3. DIMENSION b APPLIES TO PLATED TERMINAL AND IS MEASURED BETWEEN 0.15 AND 0.30mm FROM THE TERMINAL TIP.
4. DIMENSION A AND B DO NOT INCLUDE MOLD FLASH, PROTRUSIONS, OR GATE BURRS.

MILLIMETERS			
DIM	MIN	NOM	MAX
A	19.70	19.90	20.10
B	15.40	15.60	15.80
C	4.60	4.80	5.00
D	0.80	1.00	1.20
E	1.45	1.50	1.65
F	1.80	2.00	2.20
G	5.45 BSC		
H	1.20	1.40	1.60
J	0.55	0.60	0.75
K	19.80	20.00	20.20
L	18.50	18.70	18.90
P	3.30	3.50	3.70
Q	3.10	3.20	3.50
U	5.00 REF		
W	2.80	3.00	3.20

STYLE 1:

- PIN 1. BASE
2. COLLECTOR
3. EMITTER
4. COLLECTOR

STYLE 2:

- PIN 1. ANODE
2. CATHODE
3. ANODE
4. CATHODE

STYLE 3:

- PIN 1. GATE
2. DRAIN
3. SOURCE
4. DRAIN

ON Semiconductor and are registered trademarks of Semiconductor Components Industries, LLC (SCILLC). SCILLC owns the rights to a number of patents, trademarks, copyrights, trade secrets, and other intellectual property. A listing of SCILLC's product/patent coverage may be accessed at www.onsemi.com/site/pdf/Patent-Marking.pdf. SCILLC reserves the right to make changes without further notice to any products herein. SCILLC makes no warranty, representation or guarantee regarding the suitability of its products for any particular purpose, nor does SCILLC assume any liability arising out of the application or use of any product or circuit, and specifically disclaims any and all liability, including without limitation special, consequential or incidental damages. "Typical" parameters which may be provided in SCILLC data sheets and/or specifications can and do vary in different applications and actual performance may vary over time. All operating parameters, including "Typicals" must be validated for each customer application by customer's technical experts. SCILLC does not convey any license under its patent rights nor the rights of others. SCILLC products are not designed, intended, or authorized for use as components in systems intended for surgical implant into the body, or other applications intended to support or sustain life, or for any other application in which the failure of the SCILLC product could create a situation where personal injury or death may occur. Should Buyer purchase or use SCILLC products for any such unintended or unauthorized application, Buyer shall indemnify and hold SCILLC and its officers, employees, subsidiaries, affiliates, and distributors harmless against all claims, costs, damages, and expenses, and reasonable attorney fees arising out of, directly or indirectly, any claim of personal injury or death associated with such unintended or unauthorized use, even if such claim alleges that SCILLC was negligent regarding the design or manufacture of the part. SCILLC is an Equal Opportunity/Affirmative Action Employer. This literature is subject to all applicable copyright laws and is not for resale in any manner.

PUBLICATION ORDERING INFORMATION

LITERATURE FULFILLMENT:

Literature Distribution Center for ON Semiconductor
P.O. Box 5163, Denver, Colorado 80217 USA
Phone: 303-675-2175 or 800-344-3860 Toll Free USA/Canada
Fax: 303-675-2176 or 800-344-3867 Toll Free USA/Canada
Email: orderlit@onsemi.com

N. American Technical Support: 800-282-9855 Toll Free
USA/Canada
Europe, Middle East and Africa Technical Support:
Phone: 421 33 790 2910
Japan Customer Focus Center
Phone: 81-3-5817-1050

ON Semiconductor Website: www.onsemi.com

Order Literature: <http://www.onsemi.com/orderlit>

For additional information, please contact your local Sales Representative