



LED Display Product Data Sheet LTD-4830CKG-P

Spec No.: DS30-2011-0196

Effective Date: 11/18/2011

Revision: -

LITE-ON DCC

RELEASE

BNS-OD-FC001/A4

LED DISPLAY**LTD-4830CKG-P**
DATA SHEET

<u>ITEM</u>	<u>Description</u>	<u>By</u>	<u>DATE</u>
1	New Spec	Lester Chen	2011/03/18
2	Add Luminous Intensity range for 1mA	Eason Lin	2011/08/01

FEATURES

- * 0.39 inch (10.0 mm) DIGIT HEIGHT
- * CONTINUOUS UNIFORM SEGMENTS
- * LOW POWER REQUIREMENT
- * EXCELLENT CHARACTERS APPEARANCE
- * HIGH BRIGHTNESS & HIGH CONTRAST
- * WIDE VIEWING ANGLE
- * SOLID STATE RELIABILITY
- * CATEGORIZED FOR LUMINOUS INTENSITY
- * SMD DISPLAY
- * **LEAD FREE PACKAGE (ACCORDING TO ROHS)**

DESCRIPTION

The LTD-4830CKG-P is a 0.39 inch (10.0 mm) digit height dual digit SMD display. This device uses AS-AllnGaP Green LED chips (AllnGaP epi on GaAs substrate). The display has gray face and white segments.

DEVICE

PART NO.	DESCRIPTION
AllnGaP Green	Common Anode
LTD-4830CKG-P	

PACKAGE DIMENSIONS

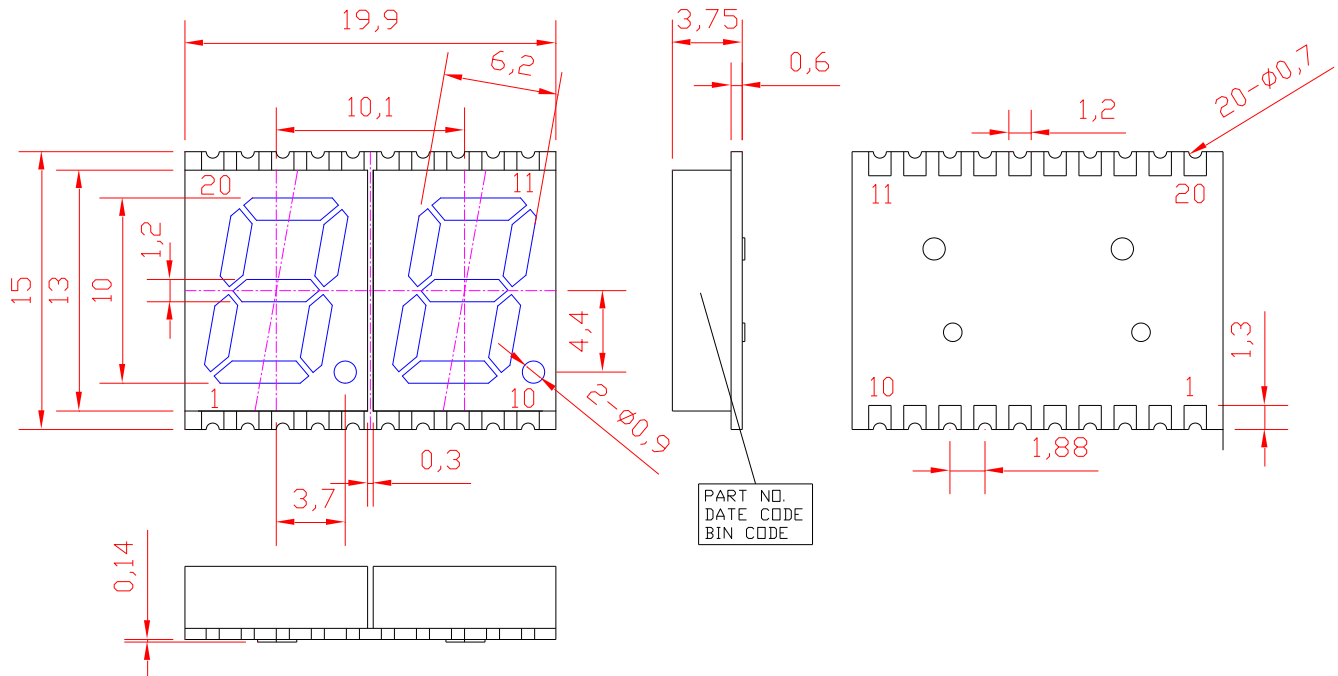

Notes:

1. All dimensions are in millimeters. Tolerances are ± 0.25 mm (0.01“) unless otherwise noted.
2. Pin tip's shift tolerance is ± 0.4 mm.

Solder Pad Vs Painting Diagram

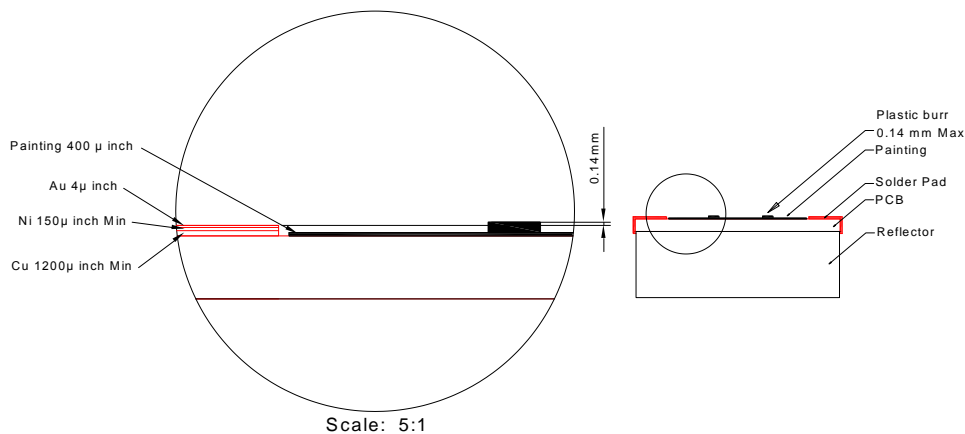

Notes:

1. Plastic pins' burr max. 0.14 mm.
2. All dimensions are in millimeters. Tolerances are ± 0.25 mm (0.01“) unless otherwise noted.
3. Solder pad materials and thickness: Cu: 1200 μ inch Ni: Min 150 μ inch Au: 4 μ inch.

INTERNAL CIRCUIT DIAGRAM

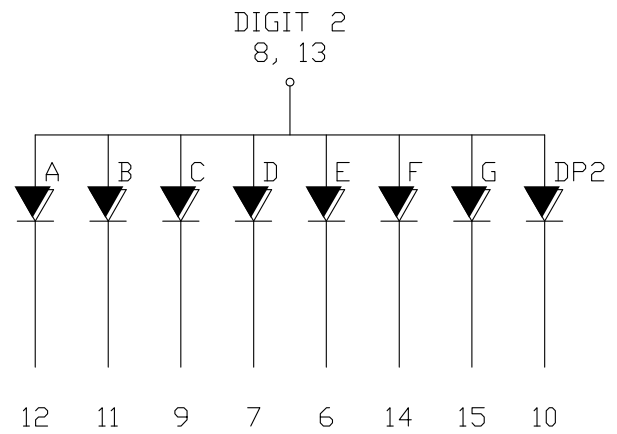
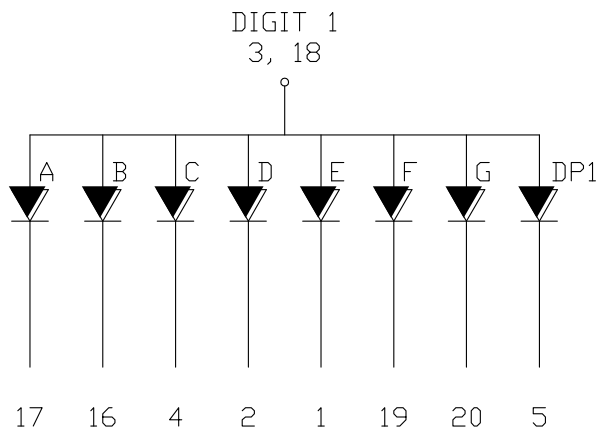
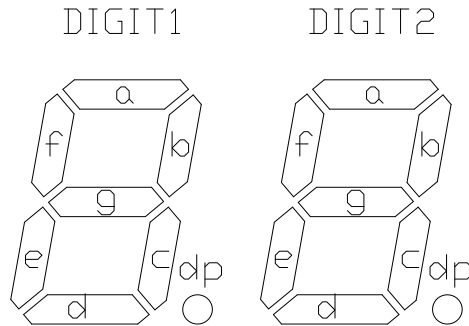

PIN CONNECTION

No.	CONNECTION
1	CATHODE (DIGIT1 E)
2	CATHODE (DIGIT1 D)
3	COMMON ANODE (DIGIT 1)
4	CATHODE (DIGIT1 C)
5	CATHODE (DIGIT1 DP)
6	CATHODE (DIGIT2 E)
7	CATHODE (DIGIT2 D)
8	COMMON ANODE (DIGIT 2)
9	CATHODE (DIGIT2 C)
10	CATHODE (DIGIT2 DP)
11	CATHODE (DIGIT2 B)
12	CATHODE (DIGIT2 A)
13	COMMON ANODE (DIGIT 2)
14	CATHODE (DIGIT2 F)
15	CATHODE (DIGIT2 G)
16	CATHODE (DIGIT1 B)
17	CATHODE (DIGIT1 A)
18	COMMON ANODE (DIGIT 1)
19	CATHODE (DIGIT1 F)
20	CATHODE (DIGIT1 G)

ABSOLUTE MAXIMUM RATING AT Ta = 25°C

PARAMETER	MAXIMUM RATING	UNIT
Power Dissipation Per Segment	70	mW
Peak Forward Current Per Segment (Frequency 1Khz,10% duty cycle)	60	mA
Continuous Forward Current Per Segment	25	mA
Forward Current Derating from 25 °C	0.28	mA/°C
Operating Temperature Range	-35 °C to +105 °C	
Storage Temperature Range	-35 °C to +105 °C	

ELECTRICAL / OPTICAL CHARACTERISTICS AT Ta = 25°C

PARAMETER	SYMBOL	MIN.	TYP.	MAX.	UNIT	TEST CONDITION
Luminous Intensity	IV	160	500		μ cd	If=1mA
Peak Emission Wavelength	λp		571		nm	If=20mA
Spectral Line Half-Width	Δλ		15		nm	If=20mA
Dominant Wavelength	λd		572		nm	If=20mA
Forward Voltage Per Segment	V _F		2.05	2.6	V	If=20mA
Reverse Current Per Segment ⁽²⁾	I _R			100	μ A	V _R =5V
Luminous Intensity Matching Ratio	I _v -m			2:1		If=1mA

Note:

- Luminous intensity is measured with a light sensor and filter combination that approximates the CIE (Commision Internationale De L'Eclairage) eye-response curve.
- Reverse voltage is only for IR test. It can not continue to operate at this situation.

TYPICAL ELECTRICAL / OPTICAL CHARACTERISTIC CURVES

(25°C Ambient Temperature Unless Otherwise Noted)

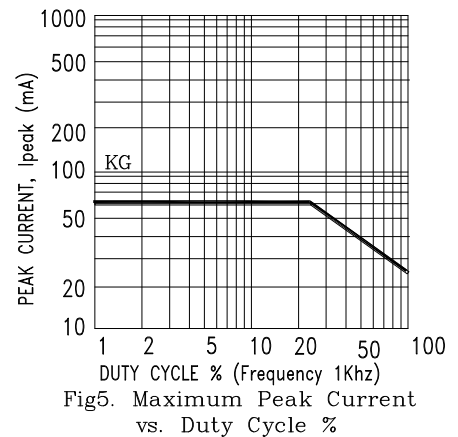
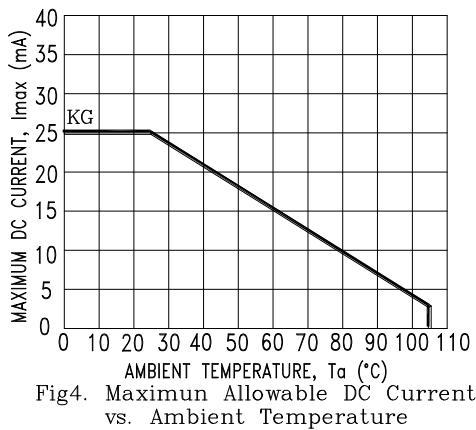
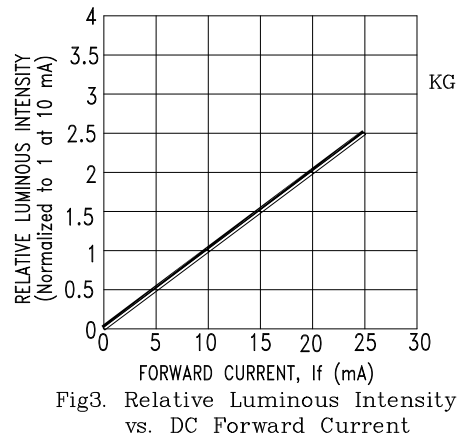
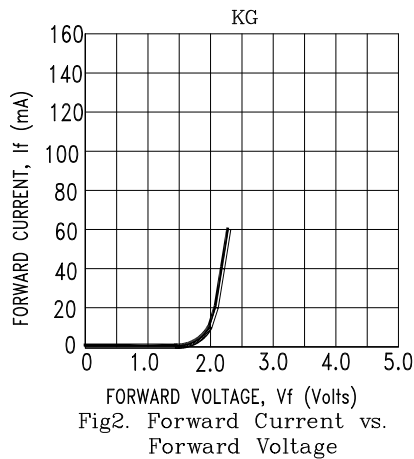
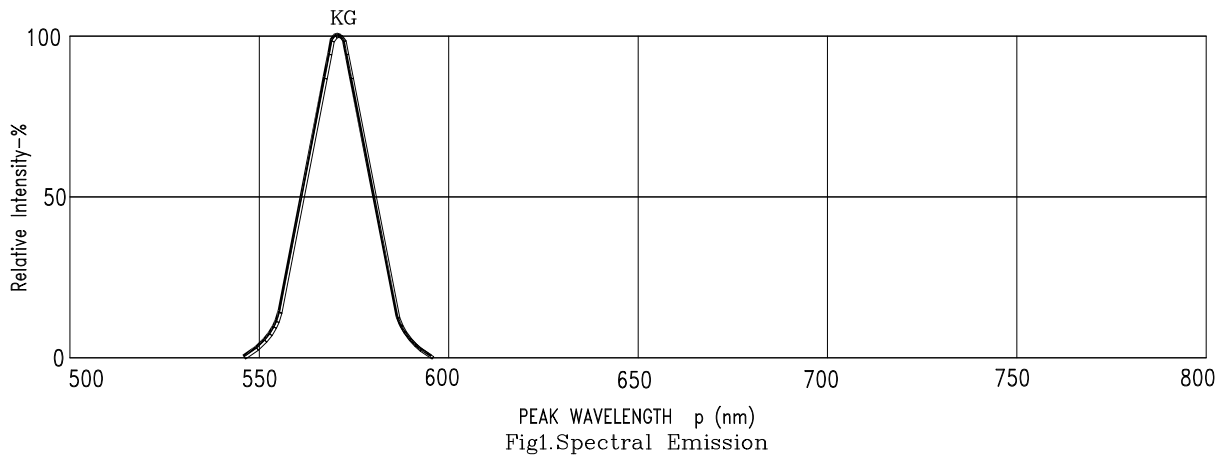

NOTE : KG=AlInGaP Green

SMT SOLDERING INSTRUCTION

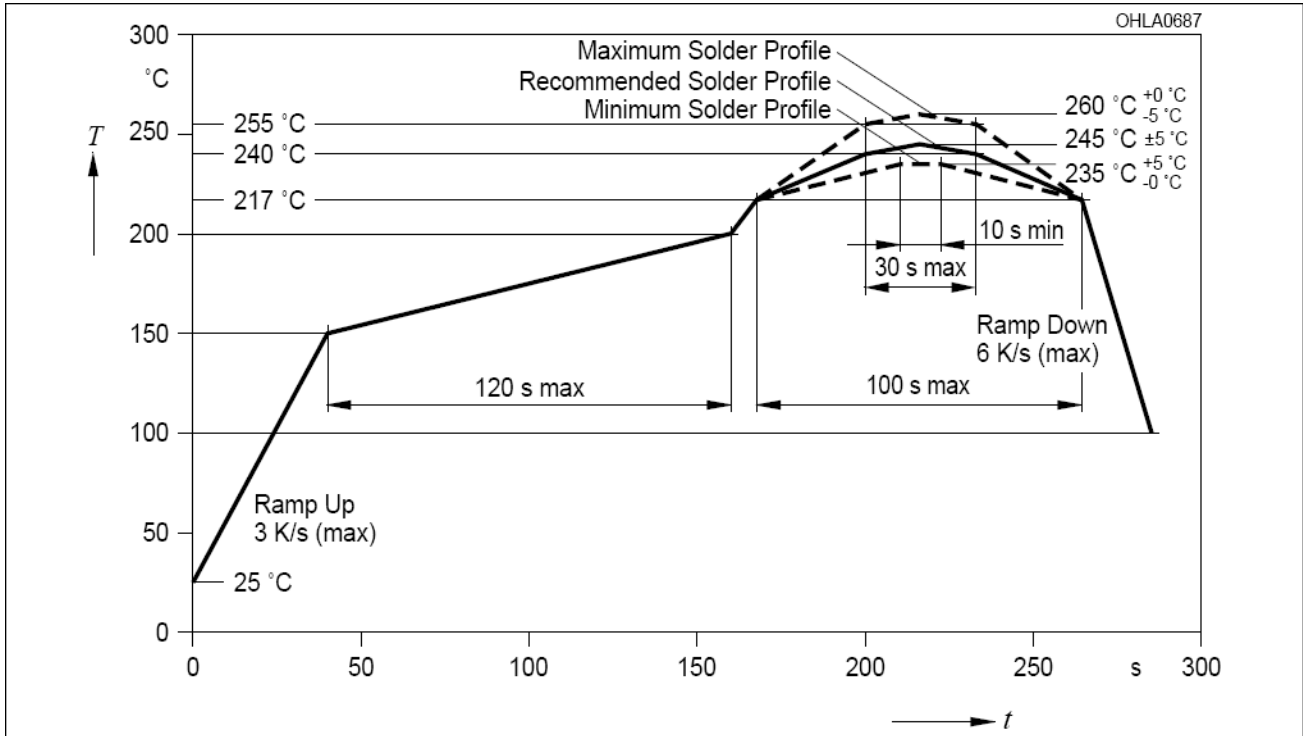

Note:

1. Recommended soldering condition:

Reflow Soldering (Two times only)		Soldering Iron (One time only)	
Pre-heat:	120~150°C.	Temperature	300°C Max.
Pre-heat time:	120sec. Max.	Soldering time	3sec. Max.
Peak temperature:	260°C Max.		
Soldering time:	5sec. Max.		

2. Number of reflow process shall be less than 2 times, and cooling process to normal temperature is required between the first and the second soldering process.

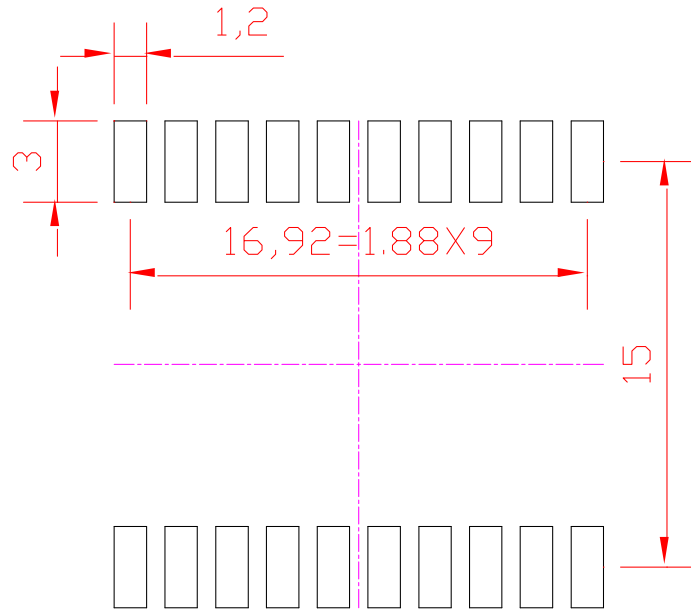
RECOMMENDED SOLDERING PATTERN

Note: All dimensions are in millimeters.

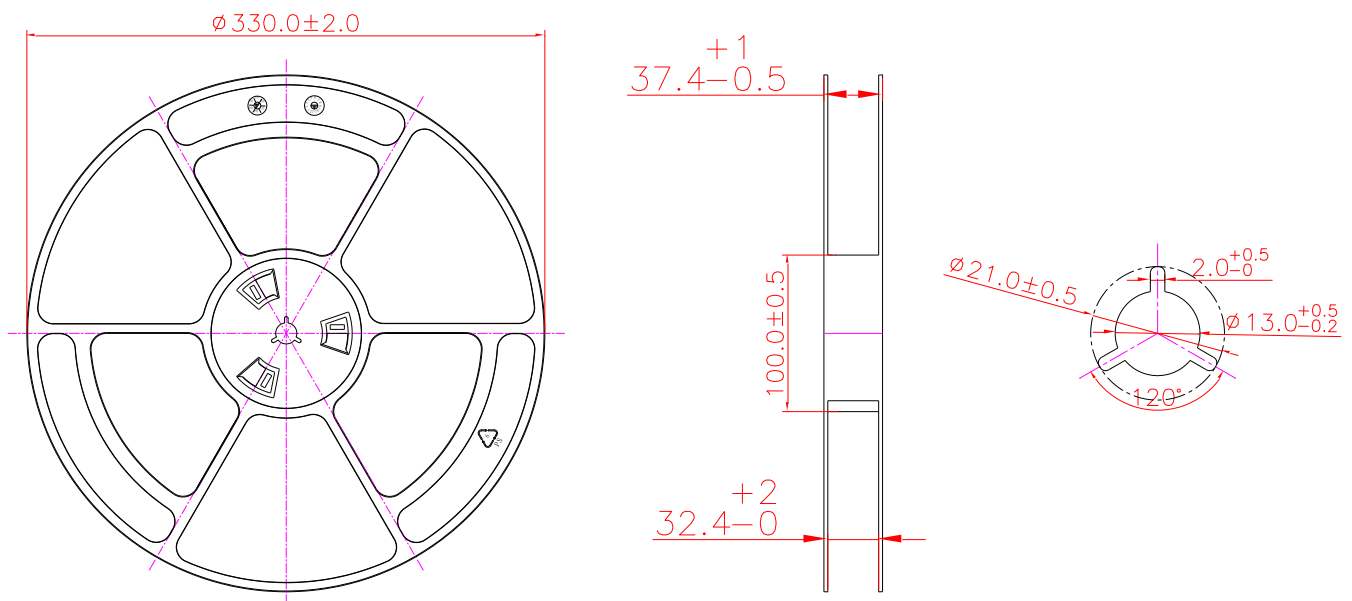
PACKING REEL DIMENSIONS

PACKING CARRIER DIMENSIONS

1. Taping parts:

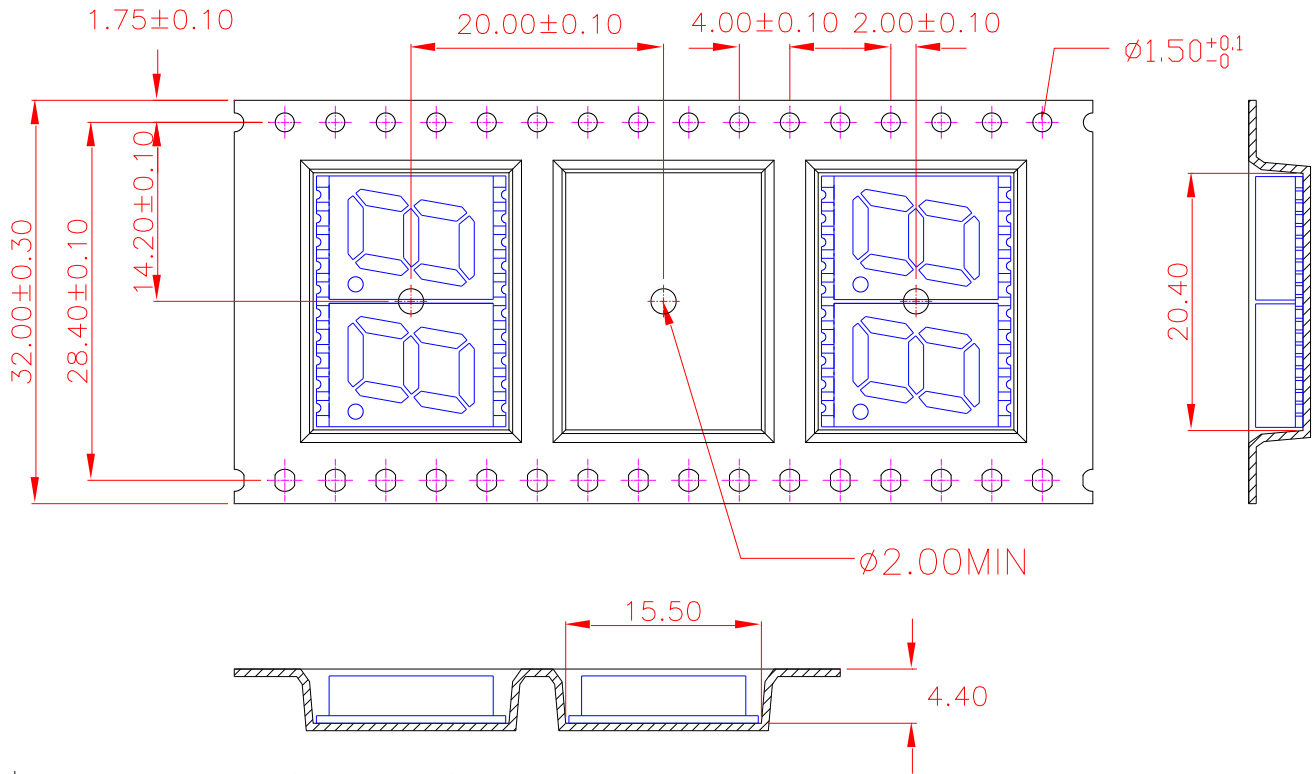

1. 10 sprocket hole pitch cumulative tolerance ± 0.20 .
2. Carrier camber is within 1 mm in 250 mm.
3. Material : Black Conductive Polystyrene Alloy.
4. All dimensions meet EIA-481-C requirements.
5. Thickness : $0.30 \pm 0.05 \text{ mm}$.
6. Packing length per 22" reel : 35.5 Meters.

2. Trailer part/ Leader part:

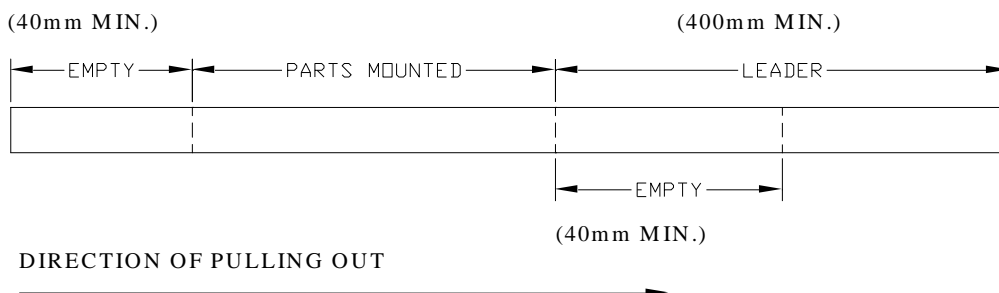

MOISTURE PROOF PACKAGING

All N/D SMD displays are shipped in moisture proof package. The displays should be stored at 30°C or less and 90% RH or less. Once the package opened, moisture absorption begins.

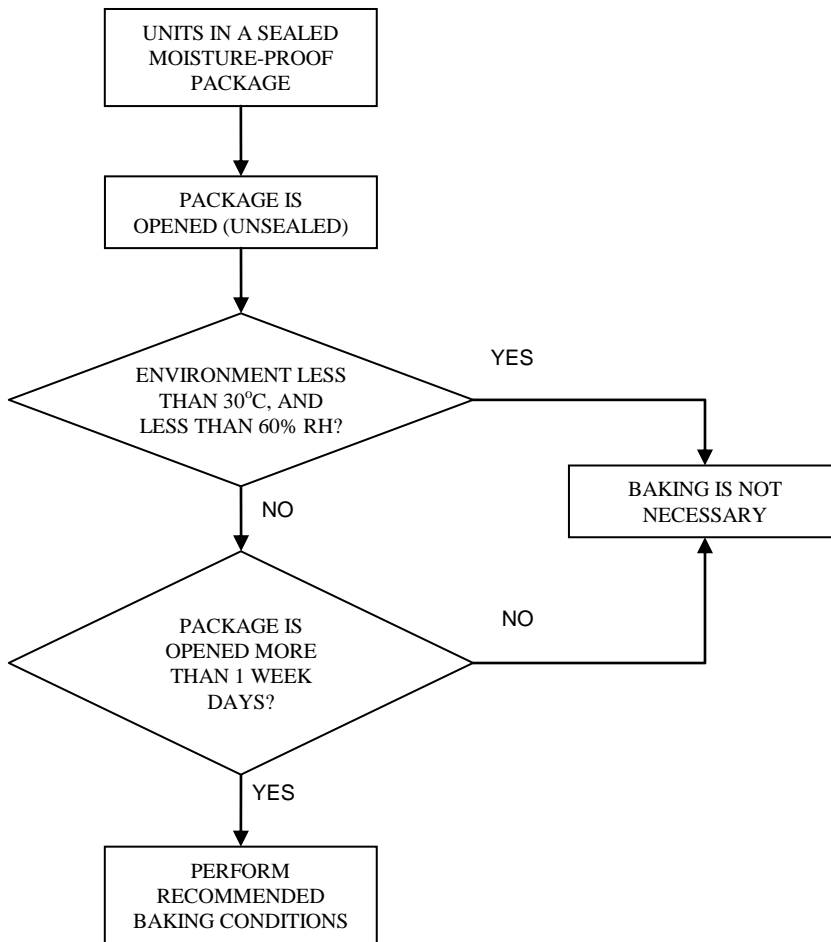

Baking Conditions

If the parts are not stored in dry conditions, they must be baked before reflow to prevent damage to the parts.

Package	Temperature	Time
In Reel	60°C	≥ 48hours
In Bulk	100°C	≥ 4hours
	125°C	≥ 2hours

Baking should only be done once.