

## Ultra Fast NPT - IGBT®

The Ultra Fast NPT - IGBT® is a new generation of high voltage power IGBTs. Using Non-Punch-Through Technology, the Ultra Fast NPT-IGBT® offers superior ruggedness and ultrafast switching speed.

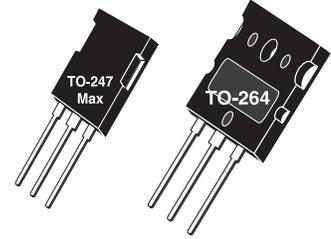

### Features

- Low Saturation Voltage
- Low Tail Current
- RoHS Compliant 
- Short Circuit Withstand Rated
- High Frequency Switching
- Ultra Low Leakage Current

Unless stated otherwise, Microsemi discrete IGBTs contain a single IGBT die. This device is recommended for applications such as induction heating (IH), motor control, general purpose inverters and uninterruptible power supplies (UPS).



### MAXIMUM RATINGS

All Ratings:  $T_C = 25^\circ\text{C}$  unless otherwise specified.

| Symbol         | Parameter  | Ratings    | Unit             |
|----------------|--|------------|------------------|
| $V_{ces}$      | Collector Emitter Voltage  | 1200       | V                |
| $V_{GE}$       | Gate-Emitter Voltage   | $\pm 30$   |                  |
| $I_{C1}$       | Continuous Collector Current @ $T_C = 25^\circ\text{C}$                              | 160        | A                |
| $I_{C2}$       | Continuous Collector Current @ $T_C = 110^\circ\text{C}$                             | 70         |                  |
| $I_{CM}$       | Pulsed Collector Current <sup>①</sup>  | 280        |                  |
| SCWT           | Short Circuit Withstand Time: $V_{CE} = 600V, V_{GE} = 15V, T_C = 125^\circ\text{C}$ | 10         | $\mu\text{s}$    |
| $P_D$          | Total Power Dissipation @ $T_C = 25^\circ\text{C}$                                   | 961        | W                |
| $T_J, T_{STG}$ | Operating and Storage Junction Temperature Range                                     | -55 to 150 | $^\circ\text{C}$ |
| $T_L$          | Max. Lead Temp. for Soldering: 0.063" from Case for 10 Sec.                          | 300        |                  |

### STATIC ELECTRICAL CHARACTERISTICS

| Symbol        | Parameter   | Min  | Typ | Max       | Unit          |
|---------------|---|------|-----|-----------|---------------|
| $V_{(BR)CES}$ | Collector-Emitter Breakdown Voltage ( $V_{GE} = 0V, I_C = 1.0mA$ )                                | 1200 |     |           | Volts         |
| $V_{GE(TH)}$  | Gate Threshold Voltage ( $V_{CE} = V_{GE}, I_C = 2.5mA, T_J = 25^\circ\text{C}$ )                 | 3.5  | 5.0 | 6.5       |               |
| $V_{CE(ON)}$  | Collector-Emitter On Voltage ( $V_{GE} = 15V, I_C = 70A, T_J = 25^\circ\text{C}$ )                |      | 2.5 | 3.2       |               |
|               | Collector-Emitter On Voltage ( $V_{GE} = 15V, I_C = 70A, T_J = 125^\circ\text{C}$ )               |      | 3.3 |           |               |
|               | Collector-Emitter On Voltage ( $V_{GE} = 15V, I_C = 140A, T_J = 25^\circ\text{C}$ )               |      | 3.5 |           |               |
| $I_{CES}$     | Collector Cut-off Current ( $V_{CE} = 1200V, V_{GE} = 0V, T_J = 25^\circ\text{C}$ ) <sup>②</sup>  |      | 10  | 1000      | $\mu\text{A}$ |
|               | Collector Cut-off Current ( $V_{CE} = 1200V, V_{GE} = 0V, T_J = 125^\circ\text{C}$ ) <sup>②</sup> |      | 100 |           |               |
| $I_{GES}$     | Gate-Emitter Leakage Current ( $V_{GE} = \pm 20V$ )   |      |     | $\pm 250$ | nA            |



**CAUTION: These Devices are Sensitive to Electrostatic Discharge. Proper Handling Procedures Should Be Followed.**

DYNAMIC CHARACTERISTICS

APT70GR120B2\_L

| Symbol          | Parameter                       | Test Conditions   | Min | Typ  | Max  | Unit    |
|-----------------|---------------------------------|---|-----|------|------|---------|
| $C_{ies}$       | Input Capacitance               | Capacitance<br>$V_{GE} = 0V, V_{CE} = 25V$<br>$f = 1MHz$                        |     | 7260 |      | pF      |
| $C_{oes}$       | Output Capacitance              |   |     | 643  |      |         |
| $C_{res}$       | Reverse Transfer Capacitance    |   |     | 199  |      |         |
| $V_{GEP}$       | Gate to Emitter Plateau Voltage | Gate Charge<br>$V_{GE} = 15V$<br>$V_{CE} = 600V$<br>$I_C = 70A$                 |     | 7.5  |      | V       |
| $Q_g^{(3)}$     | Total Gate Charge               |   |     | 412  | 544  |         |
| $Q_{ge}$        | Gate-Emitter Charge             |   |     | 48   | 62   |         |
| $Q_{gc}$        | Gate- Collector Charge          |   |     | 204  | 275  |         |
| $t_{d(on)}$     | Turn-On Delay Time              | Inductive Switching (25°C)<br>$V_{CC} = 600V$<br>$V_{GE} = 15V$<br>$I_C = 70A$  |     | 33   |      | ns      |
| $t_r$           | Current Rise Time               |   |     | 48   |      |         |
| $t_{d(off)}$    | Turn-Off Delay Time             |   |     | 278  |      |         |
| $t_f$           | Current Fall Time               |   |     | 64   |      |         |
| $E_{on2}^{(5)}$ | Turn-On Switching Energy        | $R_G = 4.3 \Omega^{(4)}$<br>$T_J = +25^\circ C$                                 |     | 3816 | 5720 | $\mu J$ |
| $E_{off}^{(6)}$ | Turn-Off Switching Energy       |   |     | 2582 | 3870 |         |
| $t_{d(on)}$     | Turn-On Delay Time              | Inductive Switching (125°C)<br>$V_{CC} = 600V$<br>$V_{GE} = 15V$<br>$I_C = 70A$ |     | 33   |      | ns      |
| $t_r$           | Current Rise Time               |   |     | 48   |      |         |
| $t_{d(off)}$    | Turn-Off Delay Time             |   |     | 320  |      |         |
| $t_f$           | Current Fall Time               |   |     | 74   |      |         |
| $E_{on2}^{(5)}$ | Turn-On Switching Energy        | $R_G = 4.3 \Omega^{(4)}$<br>$T_J = +125^\circ C$                                |     | 5651 | 8475 | $\mu J$ |
| $E_{off}^{(6)}$ | Turn-Off Switching Energy       |   |     | 3323 | 4980 |         |

THERMAL AND MECHANICAL CHARACTERISTICS

| Symbol          | Characteristic                             | Min | Typ | Max | Unit         |
|-----------------|--|-----|-----|-----|--------------|
| $R_{\theta JC}$ | Junction to Case Thermal Resistance (IGBT) |     |     | .13 | $^\circ C/W$ |
| $R_{\theta JA}$ | Junction to Ambient Thermal Resistance     |     |     | 40  |              |
| $W_T$           | Package Weight                             | B2  | .22 |     | oz           |
|                 |  | L   | 6   |     | g            |
|                 |  |     | .36 |     | oz           |
|                 |  |     | 10  |     | g            |

- 1 Repetitive Rating: Pulse width and case temperature limited by maximum junction temperature.
  - 2 Pulse test: Pulse Width < 380μs, duty cycle < 2%.
  - 3 See Mil-Std-750 Method 3471.
  - 4  $R_G$  is external gate resistance, not including internal gate resistance or gate driver impedance. (MIC4452)
  - 5  $E_{on2}$  is the clamped inductive turn on energy that includes a commutating diode reverse recovery current in the IGBT turn on energy loss. A combi device is used for the clamping diode.
  - 6  $E_{off}$  is the clamped inductive turn-off energy measured in accordance with JEDEC standard JESD24-1.
- Microsemi reserves the right to change, without notice, the specifications and information contained herein.

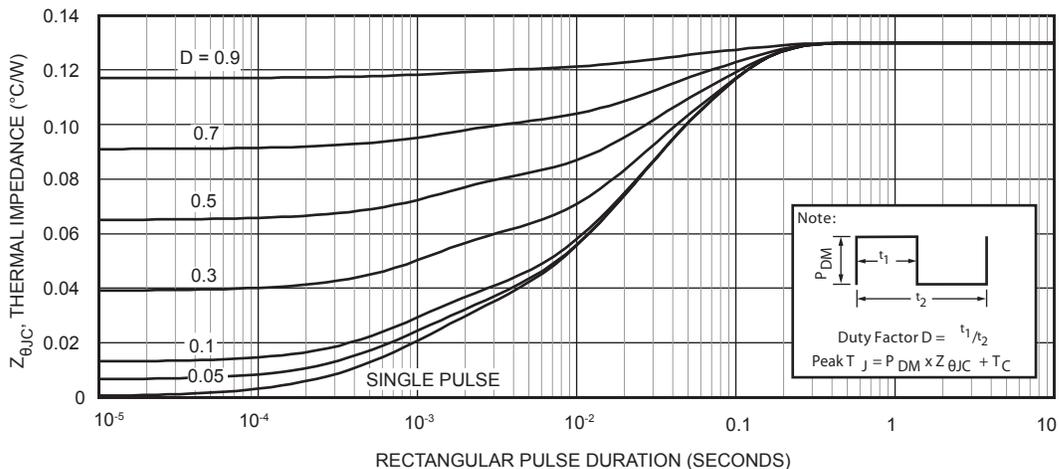

Figure 1, Maximum Effective Transient Thermal Impedance, Junction-To-Case vs Pulse Duration

TYPICAL PERFORMANCE CURVES

APT70GR120B2\_L

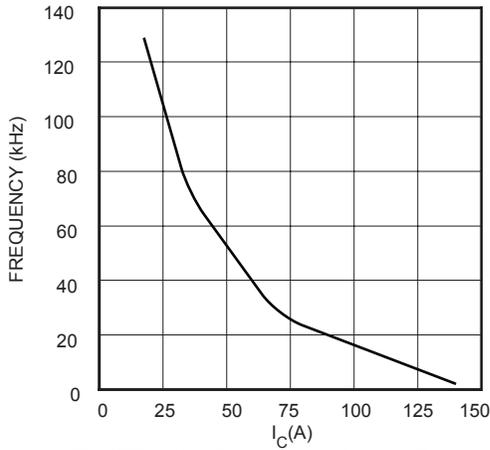

FIGURE 2, Max Frequency vs Current ( $T_{case} = 75^{\circ}C$ )

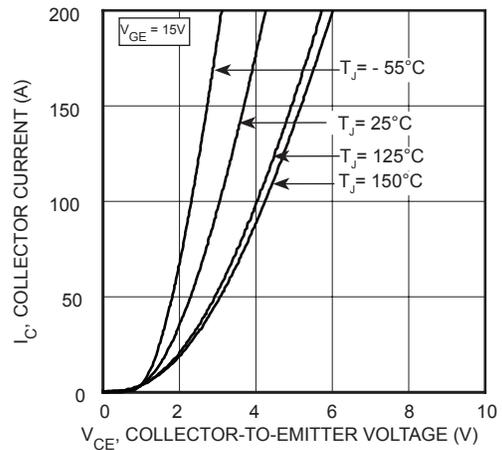

FIGURE 3, Saturation Voltage Characteristics ( $T_J = 25^{\circ}C$ )

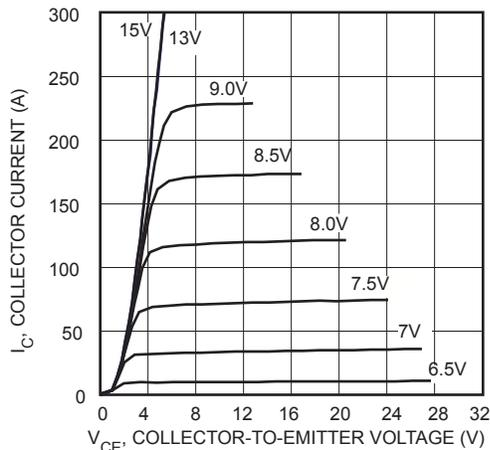

FIGURE 4, Output Characteristics ( $T_J = 25^{\circ}C$ )

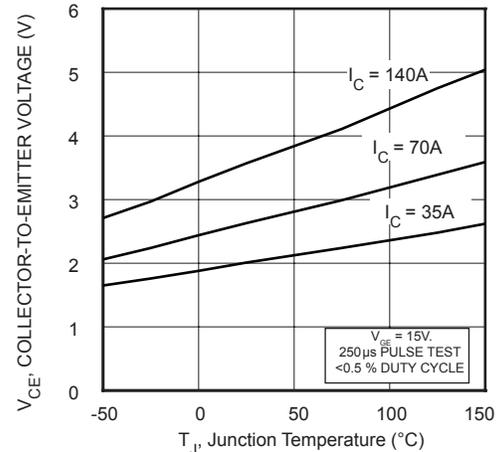

FIGURE 5, On State Voltage vs Junction Temperature

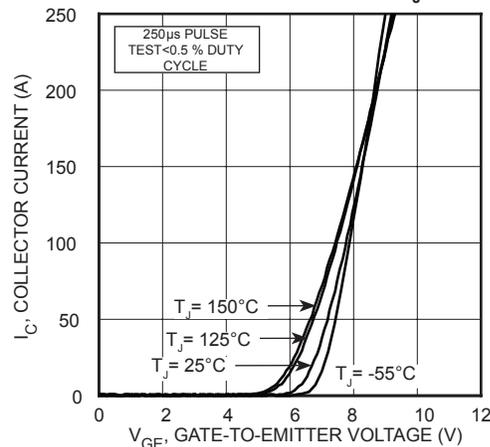

FIGURE 6, Transfer Characteristics

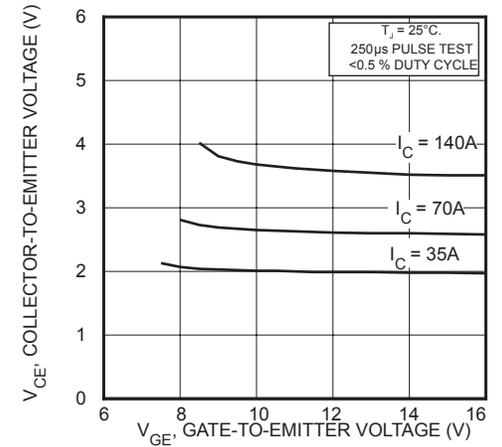

FIGURE 7, On State Voltage vs Gate-to-Emitter Voltage

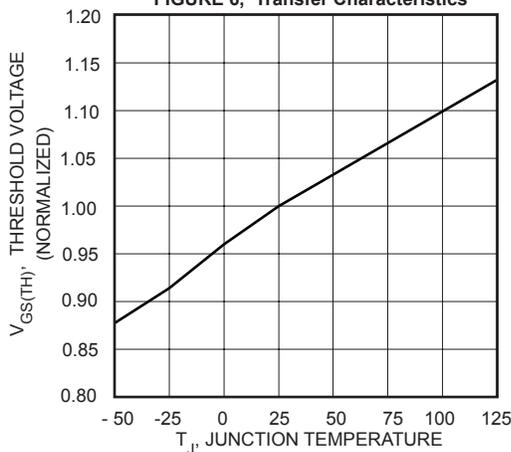

FIGURE 8, Threshold Voltage vs Junction Temperature

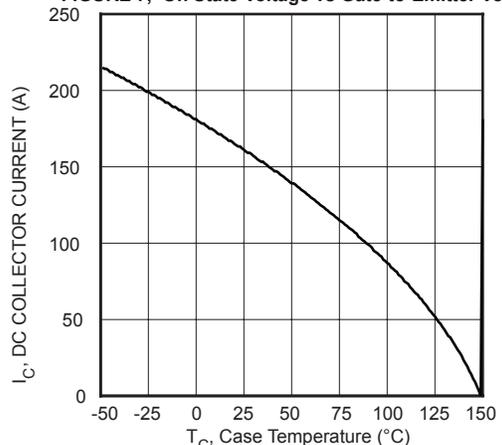

FIGURE 9, DC Collector Current vs Case Temperature

TYPICAL PERFORMANCE CURVES

APT70GR120B2\_L

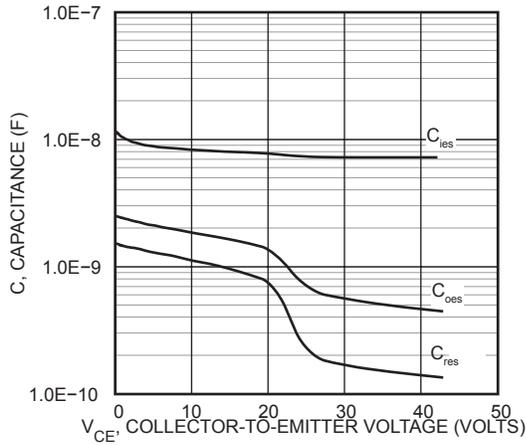

FIGURE 10, Capacitance vs Collector-To-Emitter Voltage

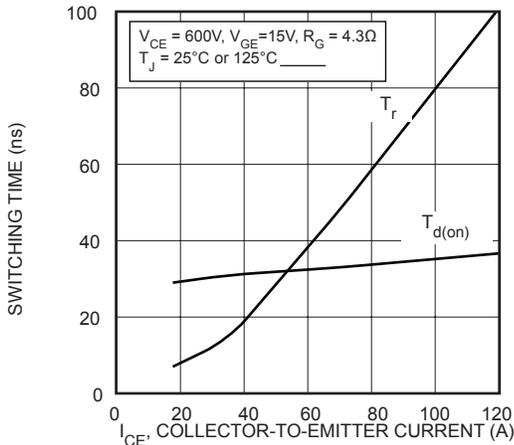

FIGURE 12, Turn-On Time vs Collector Current

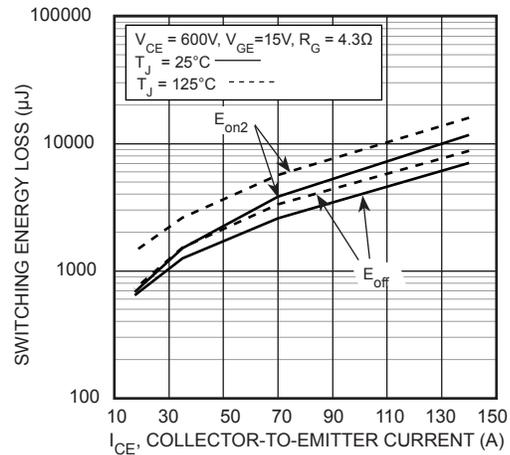

FIGURE 14, Energy Loss vs Collector Current

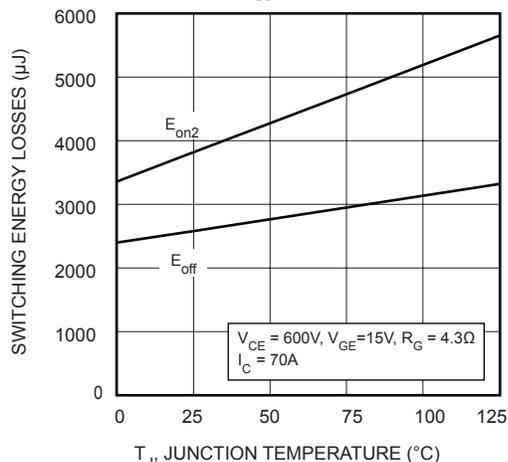

FIGURE 16, Switching Energy vs Junction Temperature

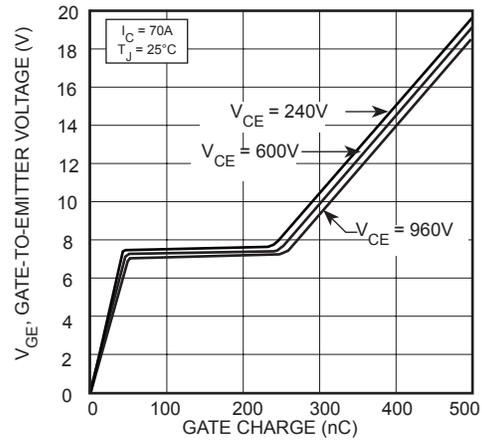

FIGURE 11, Gate charge

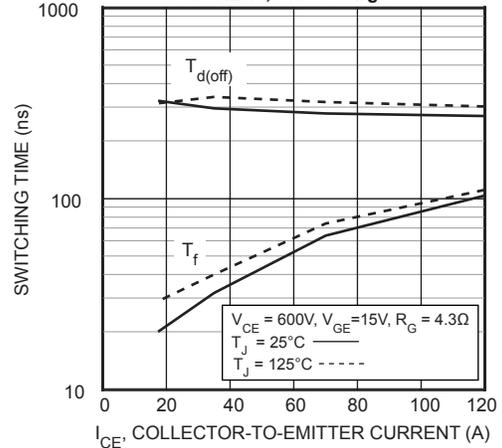

FIGURE 13, Turn-Off Time vs Collector Current

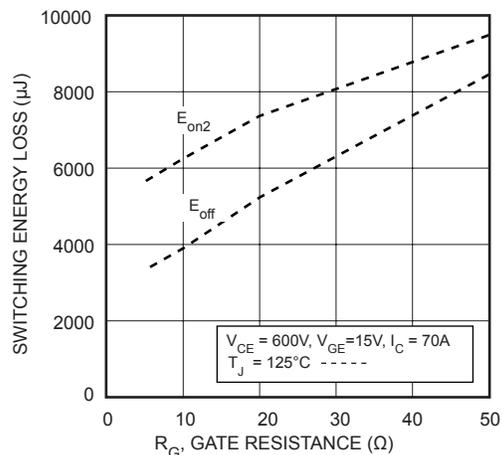

FIGURE 15, Energy Loss vs Gate Resistance

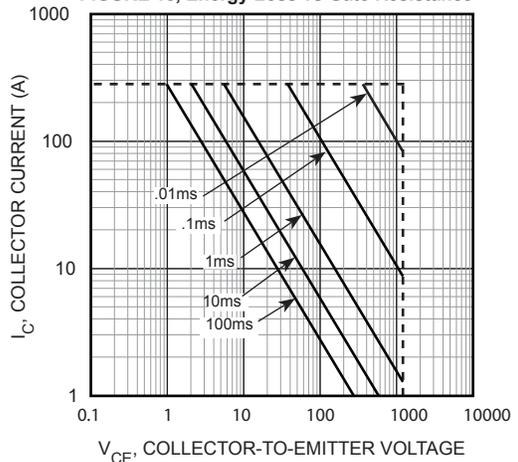
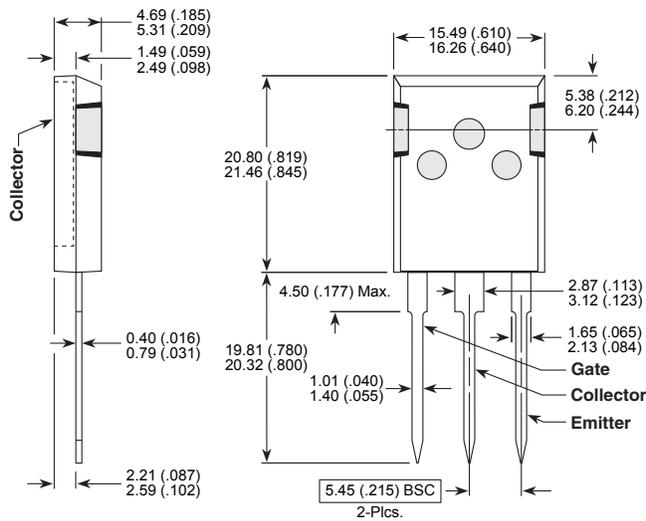

FIGURE 17, Minimum Switching Safe Operating Area

**T-MAX™ (B2) Package Outline**



These dimensions are equal to the TO-247 without the mounting hole.  
 Dimensions in Millimeters and (Inches)

**TO-264 (L) Package Outline**

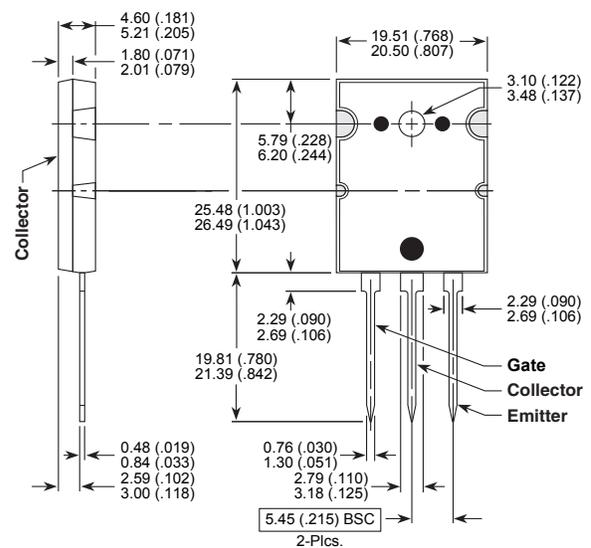

Dimensions in Millimeters and (Inches)

The information contained in the document (unless it is publicly available on the Web without access restrictions) is PROPRIETARY AND CONFIDENTIAL information of Microsemi and cannot be copied, published, uploaded, posted, transmitted, distributed or disclosed or used without the express duly signed written consent of Microsemi. If the recipient of this document has entered into a disclosure agreement with Microsemi, then the terms of such Agreement will also apply. This document and the information contained herein may not be modified, by any person other than authorized personnel of Microsemi. No license under any patent, copyright, trade secret or other intellectual property right is granted to or conferred upon you by disclosure or delivery of the information, either expressly, by implication, inducement, estoppels or otherwise. Any license under such intellectual property rights must be approved by Microsemi in writing signed by an officer of Microsemi.

Microsemi reserves the right to change the configuration, functionality and performance of its products at anytime without any notice. This product has been subject to limited testing and should not be used in conjunction with life-support or other mission-critical equipment or applications. Microsemi assumes no liability whatsoever, and Microsemi disclaims any express or implied warranty, relating to sale and/or use of Microsemi products including liability or warranties relating to fitness for a particular purpose, merchantability, or infringement of any patent, copyright or other intellectual property right. Any performance specifications believed to be reliable but are not verified and customer or user must conduct and complete all performance and other testing of this product as well as any user or customers final application. User or customer shall not rely on any data and performance specifications or parameters provided by Microsemi. It is the customer's and user's responsibility to independently determine suitability of any Microsemi product and to test and verify the same. The information contained herein is provided "AS IS, WHERE IS" and with all faults, and the entire risk associated with such information is entirely with the User. Microsemi specifically disclaims any liability of any kind including for consequential, incidental and punitive damages as well as lost profit. The product is subject to other terms and conditions which can be located on the web at <http://www.microsemi.com/legal/tnc.asp>