



3DD13009E

主要参数 MAIN CHARACTERISTICS

I_C	12A
V_{CEO}	400V
$P_C(TO-220C)$	100W
$P_C(TO-3PB)$	120W

用途

- 节能灯
- 电子镇流器
- 高频开关电源
- 高频功率变换
- 一般功率放大电路

APPLICATIONS

- Energy-saving light
- Electronic ballasts
- High frequency switching power supply
- High frequency power transform
- Commonly power amplifier

产品特性

- 高耐压
- 高电流容量
- 高开关速度
- 高可靠性
- 环保 (RoHS) 产品

FEATURES

- High breakdown voltage
- High current capability
- High switching speed
- High reliability
- RoHS product

封装 Package

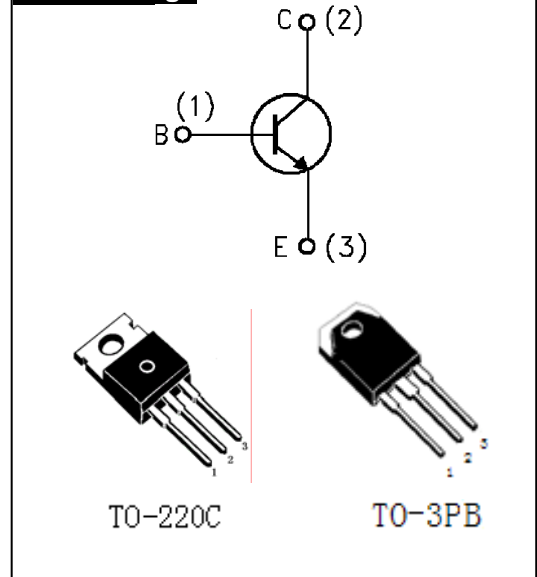

订货信息 ORDER MESSAGE

订货型号 Order codes	印记 Marking	无卤素 Halogen Free	封装 Package	包装 Packaging
3DD13009E-O-C-N-B	D13009E	否 NO	TO-220C	条管 Tube
3DD13009E-O-AB-N-B	D13009E	否 NO	TO-3PB	条管 Tube





绝对最大额定值 ABSOLUTE RATINGS (Tc=25°C)

项 目 Parameter	符 号 Symbol	数 值 Value	单 位 Unit	
集电极—发射极直流电压	Collector- Emitter Voltage ($V_{BE}=0$)	V_{CES}	700	V
集电极—发射极直流电压	Collector- Emitter Voltage ($I_B=0$)	V_{CEO}	400	V
发射极—基极直流电压	Emitter-Base Voltage	V_{EBO}	9	V
最大集电极直流电流	Collector Current (DC)	I_C	12	A
最大集电极脉冲电流	Collector Current (pulse)	I_{CP}	24	A
最大基极直流电流	Base Current (DC)	I_B	6	A
最大基极脉冲电流	Base Current (pulse)	I_{BP}	12	A
最大集电极耗散功率	Total Dissipation (TO-220C)	P_C	100	W
最大集电极耗散功率	Total Dissipation (TO-3PB)	P_C	120	W
最高结温	Junction Temperature	T_J	150	°C
贮存温度	Storage Temperature	T_{stg}	-55~+150	°C

注: pulse电流宽度为小于5ms的非重复单脉冲。 Pulse Test: Pulse Width = 5.0 ms, Duty Cycle < 10%.

电特性 ELECTRICAL CHARACTERISTIC

项 目 Parameter	测试条件 Tests conditions	最小值 Value(min)	典型值 Value(typ)	最大值 Value(max)	单 位 Unit
$V_{(BR)CEO}$	$I_C=10mA, I_B=0$	400	-	-	V
$V_{(BR)CBO}$	$I_C=1mA, I_E=0$	700	-	-	V
$V_{(BR)EBO}$	$I_E=1mA, I_C=0$	9	-	-	V
I_{CBO}	$V_{CB}=700V, I_E=0$	-	-	50	μA
I_{CEO}	$V_{CE}=400V, I_B=0$	-	-	100	μA
I_{EBO}	$V_{EB}=9V, I_C=0$	-	-	10	μA
Hfe(1)	$V_{CE}=5V, I_C=5A$	10	-	30	
Hfe(2)	$V_{CE}=5V, I_C=8A$	8	-	-	
$V_{CE(sat)}$	$I_C=8A, I_B=1.6A$	-	-	1.5	V
$V_{BE(sat)}$	$I_C=8A, I_B=1.6A$	-	-	1.6	V
tf	$V_{CC}=24V, I_C=5A, I_{B1}=-I_{B2}=1A$	-	-	0.7	μS
ts		-	-	5	μS
fT	$V_{CE}=10V, I_C=0.5A$	4	-	-	MHz

热特性 THERMAL CHARACTERISTIC

项 目 Parameter	符 号 Symbol	最小值 Value(min)	最大值 Value(max)	单 位 Unit
结到管壳的热阻 TO-220C Thermal Resistance Junction Case TO-220C	$R_{th(j-c)}$	-	1.25	°C/W
结到管壳的热阻 TO-3PN(B) Thermal Resistance Junction Case TO-3PB	$R_{th(j-c)}$	-	1.05	°C/W





特征曲线 ELECTRICAL CHARACTERISTICS (curves)

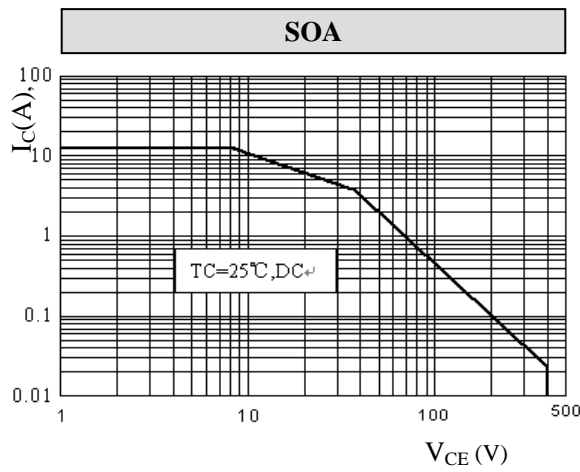
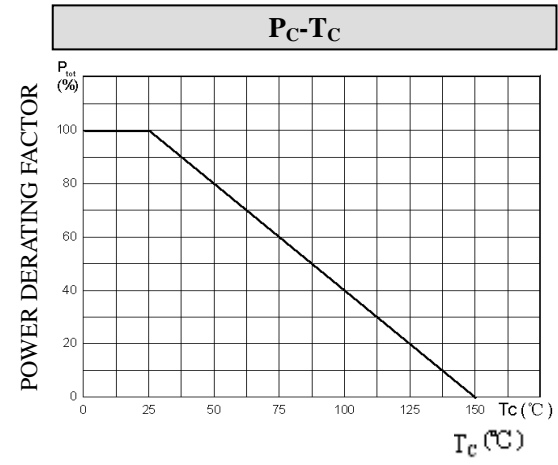
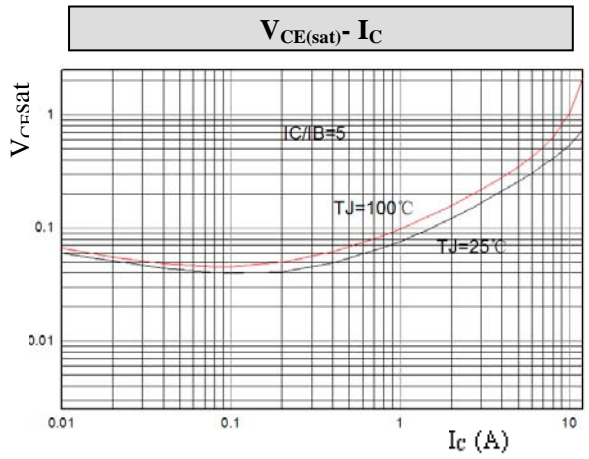
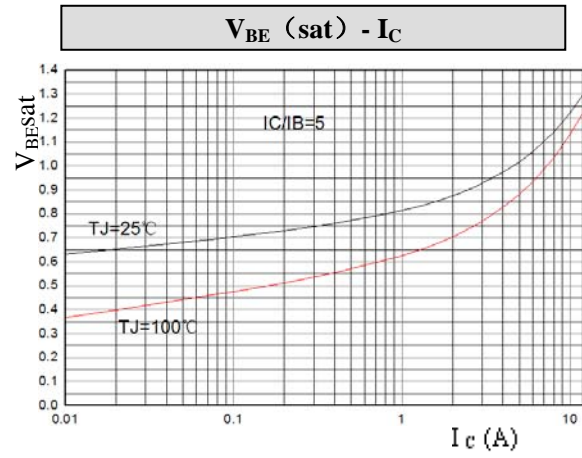
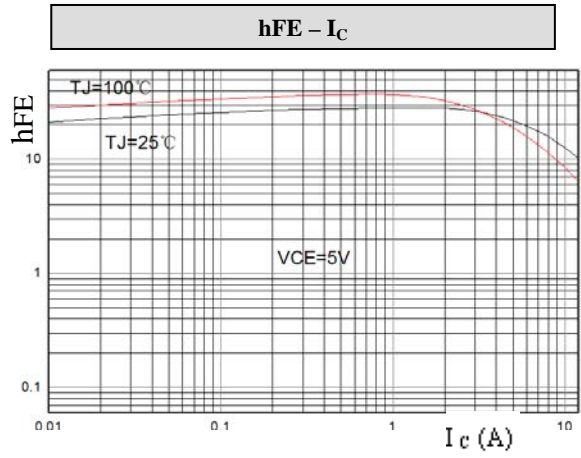



TO-220C

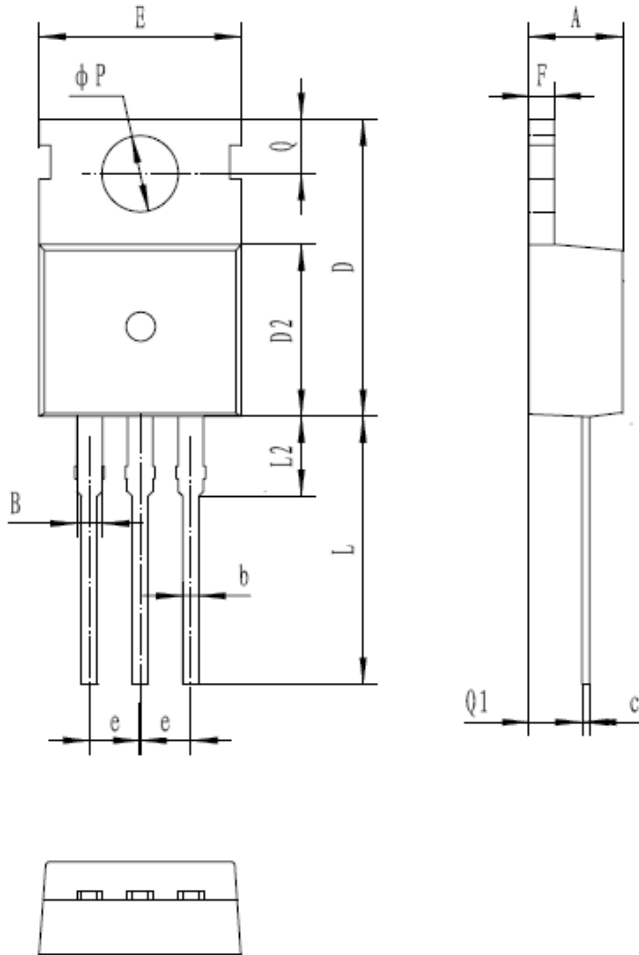

符号 symbol	MIN	MAX
A	4.30	4.70
B	1.10	1.40
b	0.70	0.95
c	0.40	0.65
D	15.20	16.20
D2	9.00	9.40
E	9.70	10.10
e	2.39	2.69
F	1.25	1.40
L	12.60	13.60
L2	2.80	3.20
Q	2.60	3.00
Q1	2.20	2.60
P	3.50	3.80





TO-3PB

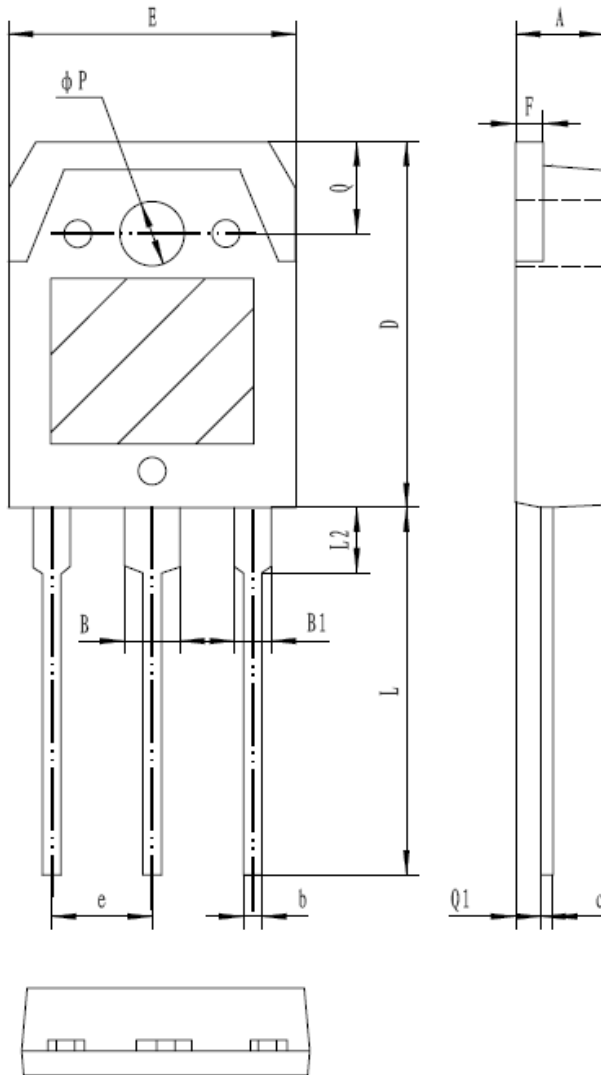

符号 symbol	MIN	MAX
A	4.60	5.00
B	2.90	3.20
B1	1.90	2.20
b	0.90	1.10
c	0.50	0.70
D	19.40	20.40
E	15.40	15.80
e	5.45(TYP)	
F	1.40	1.60
L	19.50	20.50
L2	3.30	3.70
Q1	1.30	1.50
P	3.10	3.50

