

## High Power RF LDMOS Field Effect Transistor 140 W, 2300 – 2400 MHz

### Description

The PTFB241402F integrates two LDMOS FETs into one open-cavity ceramic package. It is designed for cellular amplifier applications in the 2300 to 2400 MHz frequency band. Manufactured with Infineon's advanced LDMOS process, this device offers excellent thermal performance and superior reliability.

PTFB241402F  
Package H-37248-4

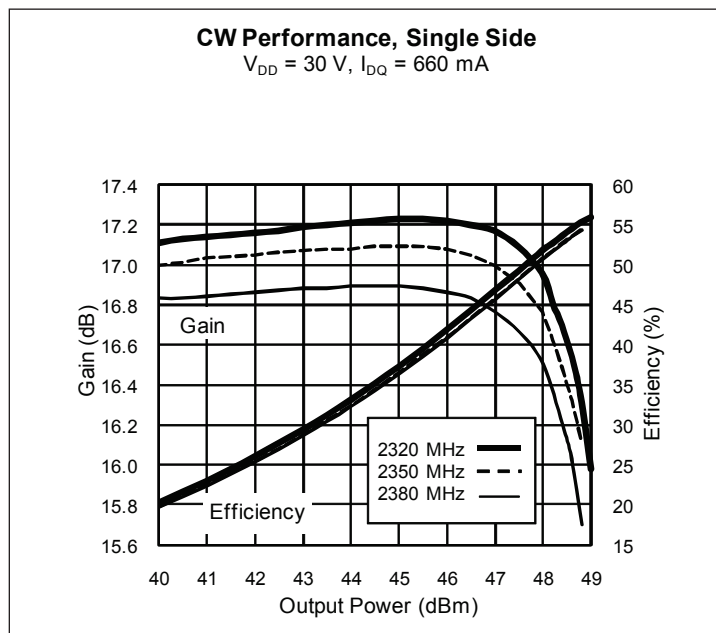

### Features

- Broadband internal matching
- Typical CW performance, single side
  - Output power (1dB compression) = 70 W
  - Efficiency = 55%
- Increased negative gate-source voltage range for improved performance in Doherty amplifiers
- Integrated ESD protection
- Excellent thermal stability
- Capable of handling 10:1 VSWR @ 30 V, 70 W (CW) output power
- Pb-free and RoHS compliant

### RF Characteristics

**Two-tone Measurements** (tested in Infineon test fixture, combined outputs)

$V_{DD} = 30\text{ V}$ ,  $I_{DQ} = 1200\text{ mA}$ ,  $P_{OUT} = 110\text{ W PEP}$ ,  $f = 2370\text{ MHz}$ , tone spacing = 1 MHz

Characteristic	Symbol	Min	Typ	Max	Unit
Gain	$G_{ps}$	16.5	17	—	dB
Drain Efficiency	$\eta_D$	34.5	37	—	%
Intermodulation Distortion	IMD	—	-32	-30	dBc

All published data at  $T_{CASE} = 25^\circ\text{C}$  unless otherwise indicated

**ESD:** Electrostatic discharge sensitive device—observe handling precautions!

**DC Characteristics** (single side)

Characteristic	Conditions	Symbol	Min	Typ	Max	Unit
Drain-Source Breakdown Voltage	$V_{GS} = 0\text{ V}$ , $I_{DS} = 10\text{ mA}$	$V_{(BR)DSS}$	65	—	—	V
Drain Leakage Current	$V_{DS} = 30\text{ V}$ , $V_{GS} = 0\text{ V}$	$I_{DSS}$	—	—	1.0	$\mu\text{A}$
Drain Leakage Current	$V_{DS} = 63\text{ V}$ , $V_{GS} = 0\text{ V}$	$I_{DSS}$	—	—	10.0	$\mu\text{A}$
On-State Resistance	$V_{GS} = 10\text{ V}$ , $V_{DS} = 0.1\text{ V}$	$R_{DS(on)}$	—	0.3	—	$\Omega$
Operating Gate Voltage	$V_{DS} = 30\text{ V}$ , $I_{DQ} = 660\text{ mA}$	$V_{GS}$	2.3	2.8	3.3	V
Gate Leakage Current	$V_{GS} = 10\text{ V}$ , $V_{DS} = 0\text{ V}$	$I_{GSS}$	—	—	1.0	$\mu\text{A}$

**Maximum Ratings**

Parameter	Symbol	Value	Unit
Drain-Source Voltage	$V_{DSS}$	65	V
Gate-Source Voltage	$V_{GS}$	-6 to +10	V
Junction Temperature	$T_J$	200	$^{\circ}\text{C}$
Storage Temperature Range	$T_{STG}$	-40 to +150	$^{\circ}\text{C}$
Thermal Resistance ( $T_{CASE} = 70^{\circ}\text{C}$ , 140 W CW)	$R_{\theta JC}$	0.38	$^{\circ}\text{C/W}$

**Ordering Information**

Type and Version	Order Code	Package Description	Shipping
PTFB241402F V1 R0	PTFB241402FV1R0XTMA1	H-37248-4, earless flange	Tape & Reel, 50 pcs
PTFB241402F V1 R250	PTFB241402FV1R250XTMA1	H-37248-4, earless flange	Tape & Reel, 250 pcs

**Typical Performance** (data taken in a production test fixture)

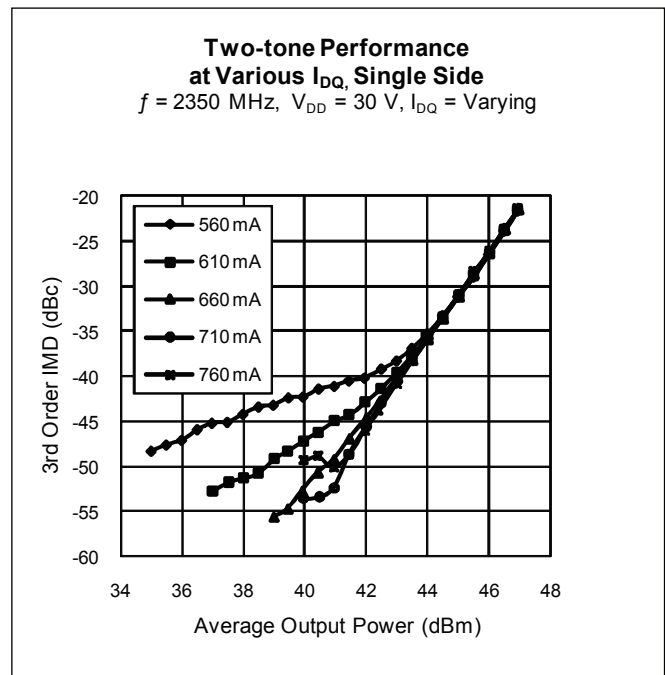
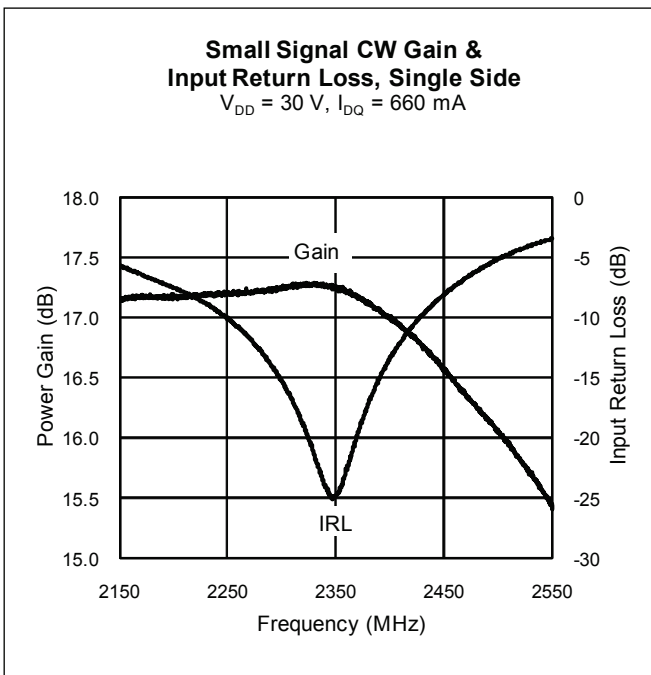
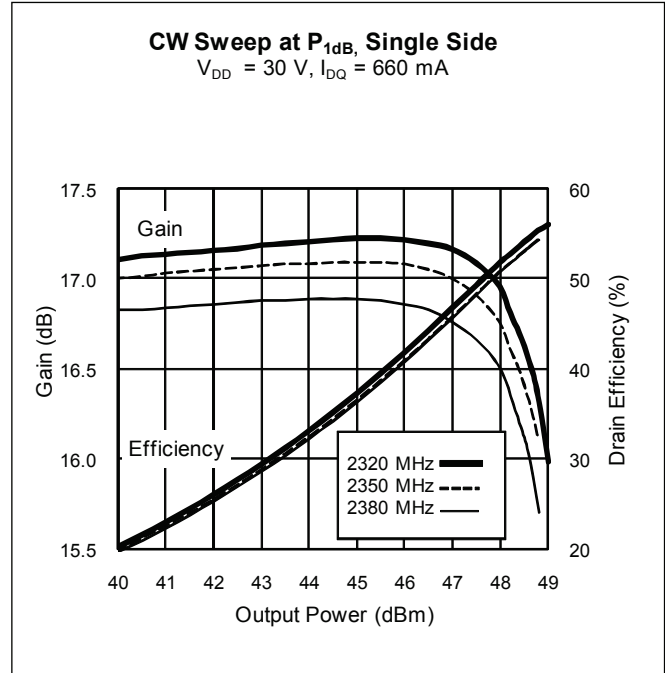
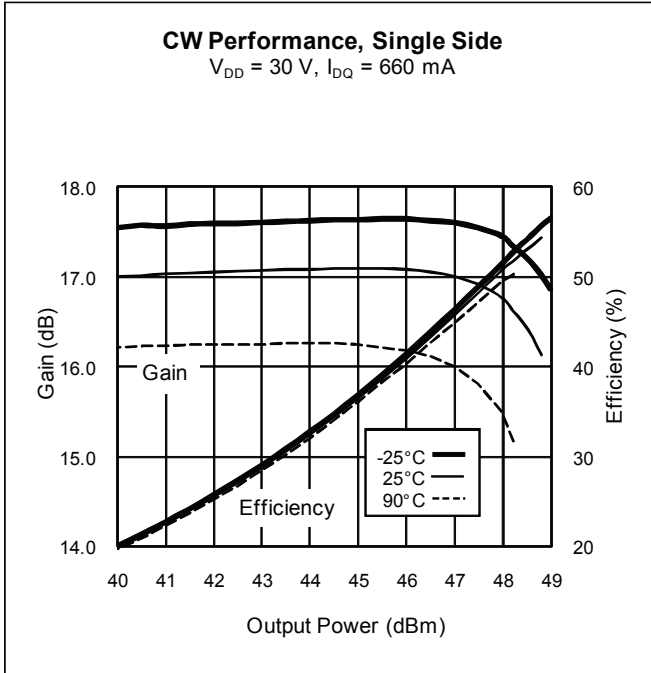

Typical Performance (cont.)

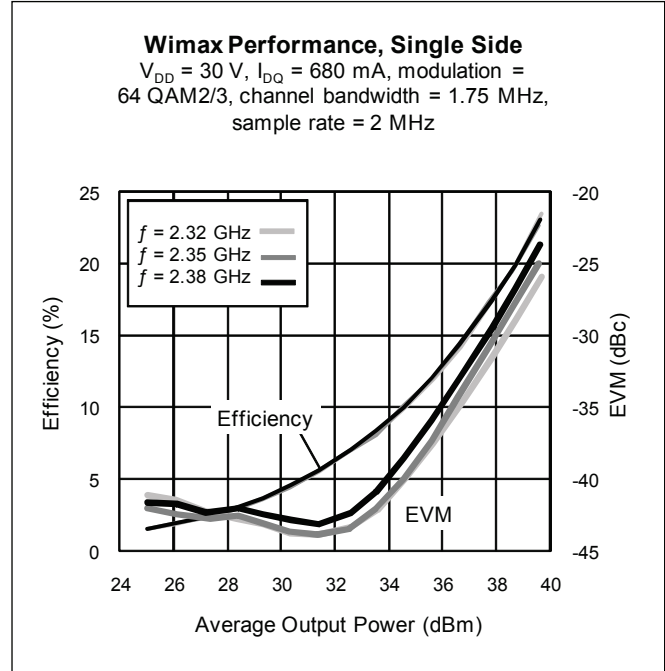
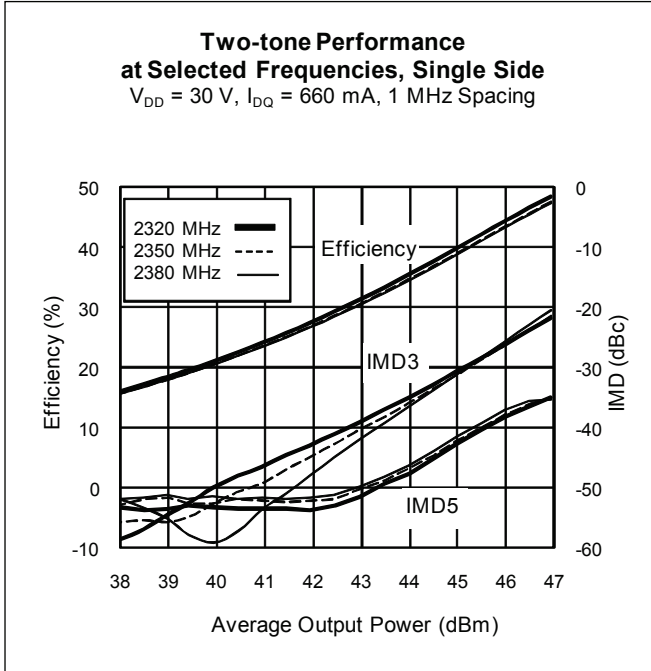

### Broadband Circuit Impedance

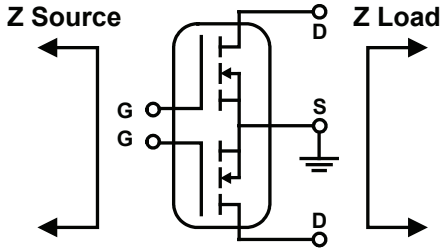

Frequency MHz	Z Source $\Omega$		Z Load $\Omega$	
	R	jX	R	jX
2320	27.0	-16.0	3.0	-4.1
2350	25.0	-8.8	3.0	-4.5
2380	27.5	-5.7	2.8	-4.5

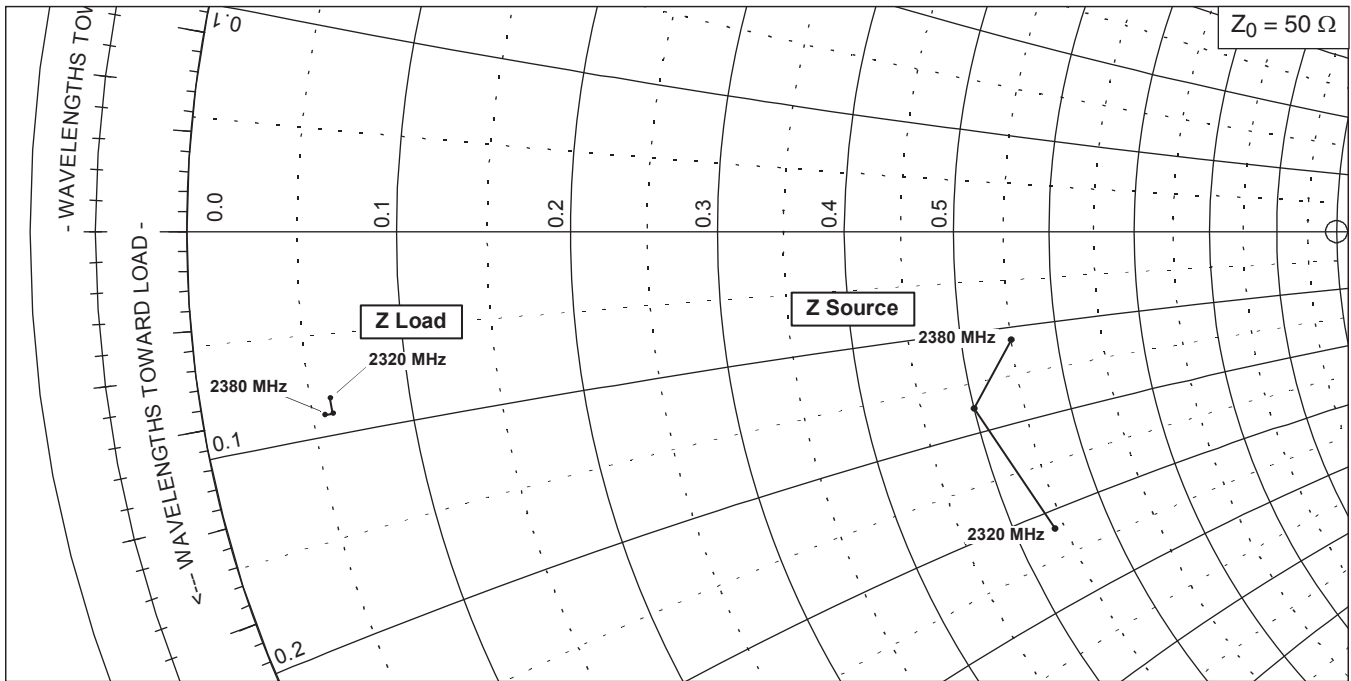

### Reference Circuit

This reference circuit is designed to test only one side at a time. This block diagram shows the configuration for testing Side 2. To test Side 1, move capacitors C807 and C901 to close the circuit to Side 1.

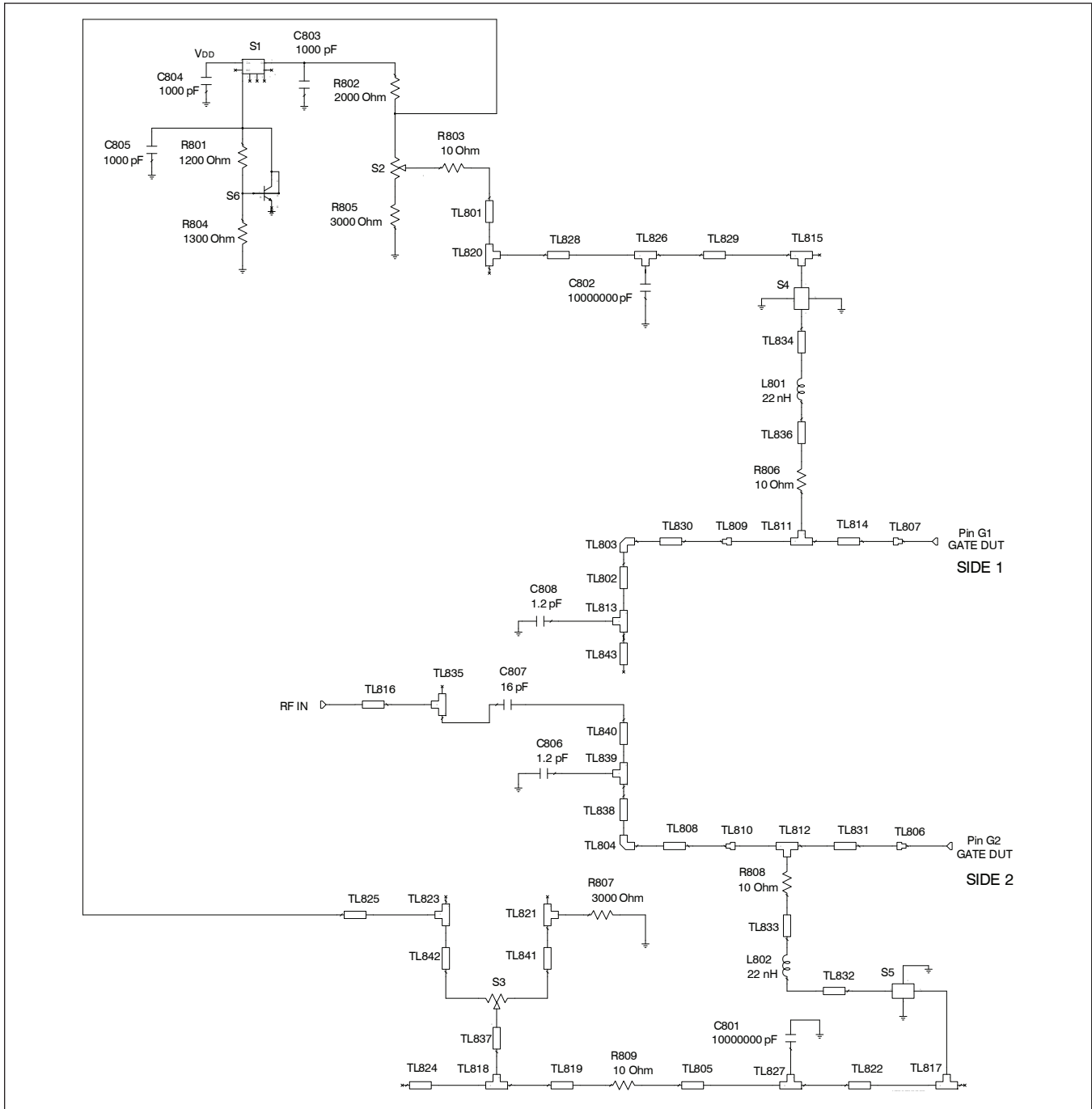

Reference circuit input schematic for  $f = 2380$  MHz



**Reference Circuit (cont.)**
**Description**

DUT	PTFB241402F
PCB	0.508 mm [.020"] thick, $\epsilon_r = 3.66$ , Rogers 4350, 1 oz. copper

**Electrical Characteristics at 2380 MHz**

Transmission Line	Electrical Characteristics	Dimensions: mm	Dimensions: mils
<b>Input</b>			
TL801	0.114 $\lambda$ , 35.71 $\Omega$	W = 1.905, L = 8.479	W = 75, L = 334
TL802, TL838	0.005 $\lambda$ , 51.98 $\Omega$	W = 1.087, L = 0.356	W = 43, L = 14
TL803, TL804		W = 1.087	W = 43
TL805	0.063 $\lambda$ , 35.71 $\Omega$	W = 1.905, L = 4.674	W = 75, L = 184
TL806, TL807		W1 = 3.810, W2 = 5.842	W1 = 150, W2 = 230
TL808	0.094 $\lambda$ , 51.98 $\Omega$	W = 1.087, L = 7.163	W = 43, L = 282
TL809		W1 = 1.087, W2 = 1.087	W1 = 43, W2 = 43
TL810		W1 = 1.087, W2 = 5.842	W1 = 43, W2 = 230
TL811, TL812	0.011 $\lambda$ , 14.61 $\Omega$	W1 = 5.842, W2 = 5.842, W3 = 0.762	W1 = 230, W2 = 230, W3 = 30
TL813, TL839	0.018 $\lambda$ , 51.98 $\Omega$	W1 = 1.087, W2 = 1.087, W3 = 1.397	W1 = 43, W2 = 43, W3 = 55
TL814	0.066 $\lambda$ , 14.61 $\Omega$	W = 5.842, L = 4.699	W = 230, L = 185
TL815, TL817, TL818, TL820, TL821, TL823	0.026 $\lambda$ , 35.71 $\Omega$	W1 = 1.905, W2 = 1.905, W3 = 1.905	W1 = 75, W2 = 75, W3 = 75
TL816	0.146 $\lambda$ , 51.98 $\Omega$	W = 1.087, L = 11.118	W = 43, L = 438
TL819	0.068 $\lambda$ , 35.71 $\Omega$	W = 1.905, L = 5.080	W = 75, L = 200
TL822, TL829	0.029 $\lambda$ , 35.71 $\Omega$	W = 1.905, L = 2.184	W = 75, L = 86
TL824, TL837	0.033 $\lambda$ , 35.71 $\Omega$	W = 1.905, L = 2.477	W = 75, L = 98
TL825	0.010 $\lambda$ , 35.71 $\Omega$	W = 1.905, L = 0.711	W = 75, L = 28
TL826, TL827	0.010 $\lambda$ , 35.71 $\Omega$	W1 = 1.905, W2 = 1.905, W3 = 0.762	W1 = 75, W2 = 75, W3 = 30
TL828	0.146 $\lambda$ , 35.71 $\Omega$	W = 1.905, L = 10.897	W = 75, L = 429
TL830	0.094 $\lambda$ , 51.98 $\Omega$	W = 1.087, L = 7.163	W = 43, L = 282
TL831	0.066 $\lambda$ , 14.61 $\Omega$	W = 5.842, L = 4.699	W = 230, L = 185
TL832, TL834	0.027 $\lambda$ , 35.71 $\Omega$	W = 1.905, L = 2.032	W = 75, L = 80
TL833	0.036 $\lambda$ , 35.71 $\Omega$	W = 1.905, L = 2.705	W = 75, L = 107
TL835	0.014 $\lambda$ , 44.26 $\Omega$	W1 = 1.397, W2 = 1.397, W3 = 1.087	W1 = 55, W2 = 55, W3 = 43
TL836	0.032 $\lambda$ , 35.71 $\Omega$	W = 1.905, L = 2.408	W = 75, L = 95
TL840, TL843	0.010 $\lambda$ , 51.98 $\Omega$	W = 1.087, L = 0.762	W = 43, L = 30
TL841, TL842	0.026 $\lambda$ , 35.71 $\Omega$	W = 1.905, L = 1.905	W = 75, L = 75

*table continued on page 9*



**Reference Circuit** (cont.)

**Electrical Characteristics at 2380 MHz**

<b>Transmission Line</b>	<b>Electrical Characteristics</b>	<b>Dimensions: mm</b>	<b>Dimensions: mils</b>
<b>Output</b>			
TL901, TL902	0.077 $\lambda$ , 28.85 $\Omega$	W = 2.540, L = 5.690	W = 100, L = 24
TL903	0.031 $\lambda$ , 28.85 $\Omega$	W = 2.540, L = 2.286	W = 100, L = 90
TL904	0.036 $\lambda$ , 28.85 $\Omega$	W = 2.540, L = 2.667	W = 100, L = 105
TL905, TL931	0.019 $\lambda$ , 28.85 $\Omega$	W1 = 2.540, W2 = 2.540, W3 = 1.397	W1 = 100, W2 = 100, W3 = 55
TL906	0.078 $\lambda$ , 14.61 $\Omega$	W = 5.842, L = 5.588	W = 230, L = 220
TL907		W1 = 0.003, W2 = 0.003, Offset = 0.001	W1 = 3, W2 = 102, Offset = 50
TL908, TL909	0.069 $\lambda$ , 28.85 $\Omega$	W1 = 2.540, W2 = 2.540, W3 = 5.080	W1 = 100, W2 = 100, W3 = 200
TL910	0.063 $\lambda$ , 51.98 $\Omega$	W = 1.087, L = 4.826	W = 43, L = 190
TL911, TL912		W = 1.087	W = 43
TL913, TL914		W1 = 1.087, W2 = 5.842	W1 = 43, W2 = 230
TL915	0.078 $\lambda$ , 14.61 $\Omega$	W = 5.842, L = 5.588	W = 230, L = 220
TL916, TL925		W1 = 3.810, W2 = 5.842	W1 = 150, W2 = 230
TL917	0.063 $\lambda$ , 51.98 $\Omega$	W = 1.087, L = 4.826	W = 43, L = 190
TL918	0.014 $\lambda$ , 51.98 $\Omega$	W1 = 1.087, W2 = 1.087, W3 = 1.087	W1 = 43, W2 = 43, W3 = 43
TL919, TL920	0.027 $\lambda$ , 51.98 $\Omega$	W = 1.087, L = 2.032	W = 43, L = 80
TL921	0.117 $\lambda$ , 51.98 $\Omega$	W = 1.087, L = 8.890	W = 43, L = 350
TL922, TL940	0.009 $\lambda$ , 28.85 $\Omega$	W = 2.540, L = 0.655	W = 100, L = 26
TL923, TL926, TL942 TL944	0.025 $\lambda$ , 28.85 $\Omega$	W1 = 2.540, W2 = 2.540, W3 = 1.829	W1 = 100, W2 = 100, W3 = 72
TL924	0.031 $\lambda$ , 28.85 $\Omega$	W = 2.540, L = 2.286	W = 100, L = 90
TL927, TL929		W = 2.540	W = 100
TL928, TL941	0.086 $\lambda$ , 28.85 $\Omega$	W = 2.540, L = 6.363	W = 100, L = 251
TL930	0.036 $\lambda$ , 28.85 $\Omega$	W = 2.540, L = 2.667	W = 100, L = 105
TL932, TL936	0.073 $\lambda$ , 16.19 $\Omega$	W = 5.182, L = 5.207	W = 204, L = 205
TL933, TL937	0.050 $\lambda$ , 28.85 $\Omega$	W = 2.540, L = 3.670	W = 100, L = 145
TL934, TL939	0.038 $\lambda$ , 28.85 $\Omega$	W1 = 2.540, W2 = 2.540, W3 = 2.794	W1 = 100, W2 = 100, W3 = 110
TL935, TL938	0.136 $\lambda$ , 28.85 $\Omega$	W = 2.540, L = 10.020	W = 100, L = 395
TL943		W1 = 0.003, W2 = 0.003, Offset = -0.001	W1 = 3, W2 = 102, Offset = -50
TL945, TL946	0.036 $\lambda$ , 14.61 $\Omega$	W1 = 5.842, W2 = 5.842, W3 = 2.540	W1 = 230, W2 = 230, W3 = 100

Reference Circuit (cont.)

Circuit Assembly Information

Test Fixture Part No. LTN/PTFB241402F

Find Gerber files for this test fixture on the Infineon Web site at <http://www.infineon.com/rfpower>

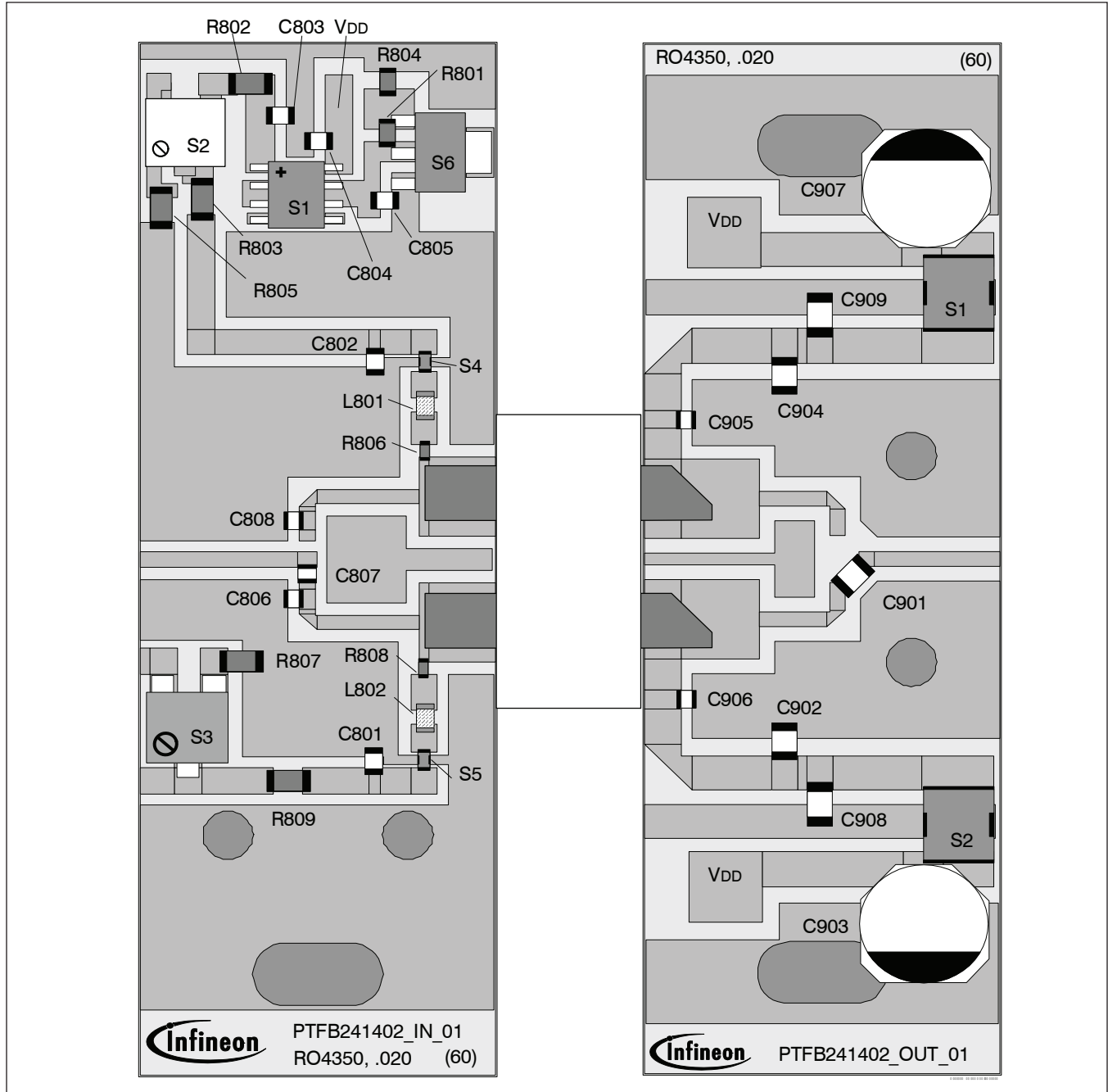

Reference circuit assembly diagram (not to scale)

**Reference Circuit** (cont.)

**Components Information**

Component	Description	Suggested Manufacturer	P/N
<b>Input</b>			
C801, C802	Capacitor, 10 $\mu$ F	Digi-Key	490-3905-6-ND
C803, C804, C805	Capacitor, 1000 pF	Digi-Key	PCC1772CT-ND
C806, C808	Chip capacitor, 1.2 pF	ATC	ATC100A1R2BW150XB
C807	Chip capacitor, 16 pF	ATC	ATC100A160FW150XB
L801, L802	Inductor, 22 nH	Digi-Key	TKS2349CT-ND
R801	Resistor, 1200 $\Omega$	Digi-Key	P1.2KGCT-ND
R802	Resistor, 2000 $\Omega$	Digi-Key	P2.0KECT-ND
R803, R809	Resistor, 10 $\Omega$	Digi-Key	P10ECT-ND
R804	Resistor, 1300 $\Omega$	Digi-Key	P1.3KGCT-ND
R805, R807	Resistor, 3000 $\Omega$	Digi-Key	P3.0KECT-ND
R806, R808	Resistor, 10 $\Omega$	Digi-Key	P10GCT-ND
S1	Voltage Regulator	National Semiconductor	LM7805
S2, S3	Potentiometer, 2k $\Omega$	Digi-Key	3224W-202ECT-ND
S4, S5	EMI filter, 2 - 4 A, 0.1 - 2.2 $\mu$ F	Murata	NFM18P
S6	Transistor	Infineon Technologies	BCP56
<b>Output</b>			
C901, C902, C904	Chip capacitor, 7.5 pF	ATC	ATC100B7R5BW500XB
C903, C907	Capacitor, 100 $\mu$ F	Digi-Key	PCE3718CT-ND
C905, C906	Chip capacitor, 2.4 pF	ATC	ATC100A2R4BW150XB
C908, C909	Capacitor, 10 $\mu$ F	Digi-Key	490-1891-2-ND
S1, S2	EMI filter, 6 A, 1.5 $\mu$ F	Murata	NFM55P

**Pinout Diagram**

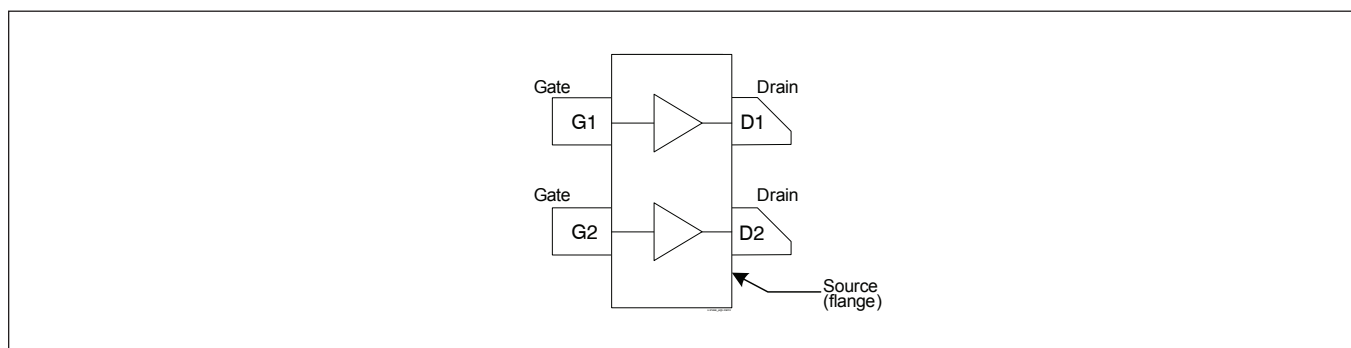

Lead connections for PTFB241402F

Package Outline Specifications

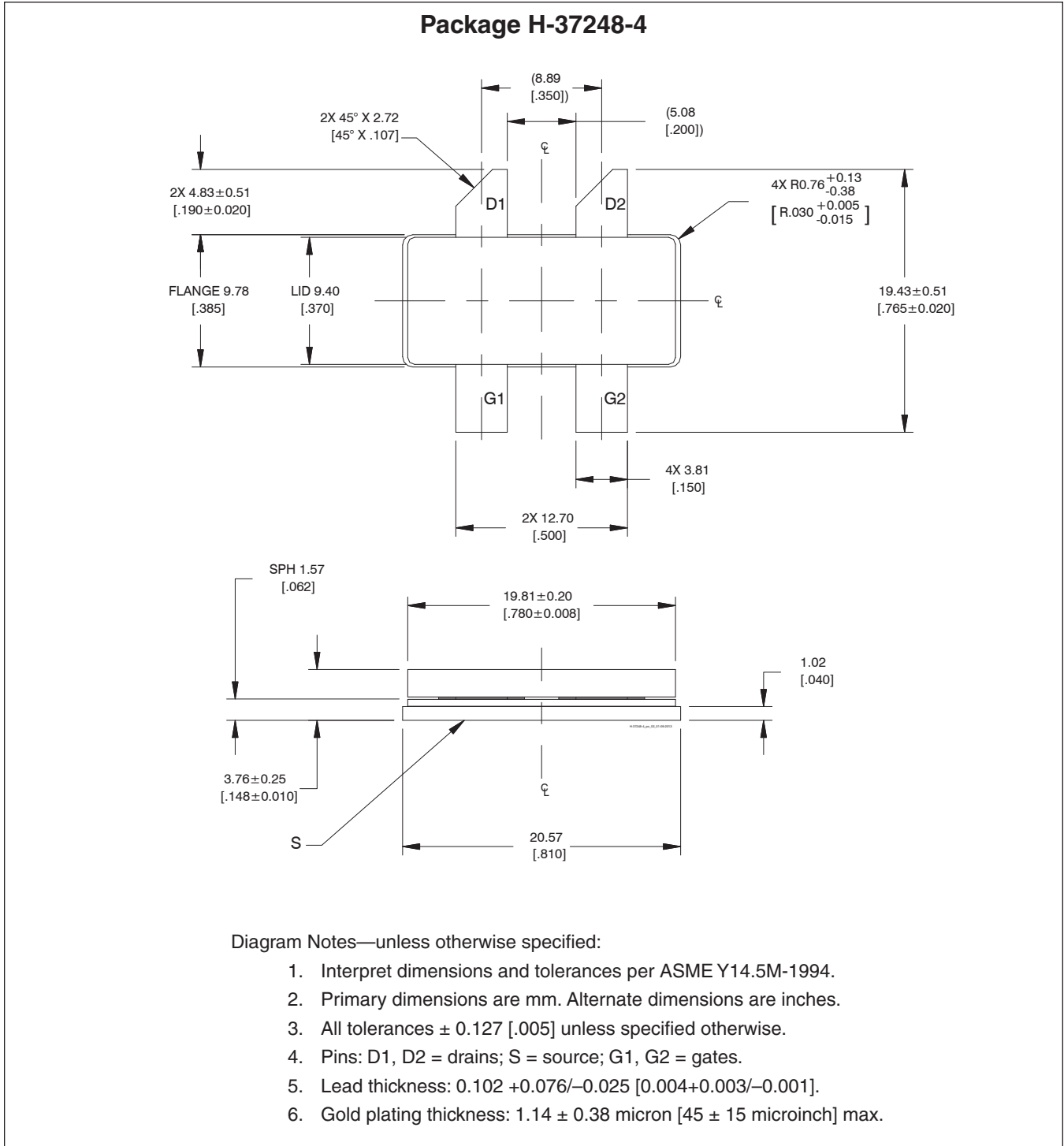

Find the latest and most complete information about products and packaging at the Infineon Internet page <http://www.infineon.com/rfpower>

Previous Version: 2011-04-04, Data Sheet

Page	Subjects (major changes since last revision)
2	Updated ordering information

**We Listen to Your Comments**

Any information within this document that you feel is wrong, unclear or missing at all?  
Your feedback will help us to continuously improve the quality of this document.  
Please send your proposal (including a reference to this document) to:

[highpowerRF@infineon.com](mailto:highpowerRF@infineon.com)

To request other information, contact us at:  
+1 877 465 3667 (1-877-GO-LDMOS) USA  
or +1 408 776 0600 International

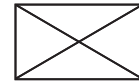

**Edition 2016-06-15**

**Published by  
Infineon Technologies AG  
81726 Munich, Germany**

**© 2010 Infineon Technologies AG  
All Rights Reserved.**

**Legal Disclaimer**

The information given in this document shall in no event be regarded as a guarantee of conditions or characteristics. With respect to any examples or hints given herein, any typical values stated herein and/or any information regarding the application of the device, Infineon Technologies hereby disclaims any and all warranties and liabilities of any kind, including without limitation, warranties of non-infringement of intellectual property rights of any third party.

**Information**

For further information on technology, delivery terms and conditions and prices, please contact the nearest Infineon Technologies Office ([www.infineon.com/rfpower](http://www.infineon.com/rfpower)).

**Warnings**

Due to technical requirements, components may contain dangerous substances. For information on the types in question, please contact the nearest Infineon Technologies Office.

Infineon Technologies components may be used in life-support devices or systems only with the express written approval of Infineon Technologies, if a failure of such components can reasonably be expected to cause the failure of that life-support device or system or to affect the safety or effectiveness of that device or system. Life support devices or systems are intended to be implanted in the human body or to support and/or maintain and sustain and/or protect human life. If they fail, it is reasonable to assume that the health of the user or other persons may be endangered.