

### 150mA CMOS High Performance LDO Regulator

The KIC3213series Low Dropout Linear Regulator is ideally suited for portable applications. It offers 1% initial accuracy, extremely-low dropout voltage(210mV at 150mA, 3.3V Output Type), low ground current (typically 36uA) and ultra small package(UDFN1010-4). Designed specifically for handheld and battery-powered devices, the KIC3213series provides a TTL-logic-compatible ON/OFF control pin. When disabled, power consumption drops nearly to zero. The KIC3213series also works with low-ESR ceramic capacitors, reducing the amount of board space necessary for power applications, critical in handheld wireless devices. The Line transient response and load transient response of the KIC3213series are very excellent, thus ICs are very suitable for the power supply for hand-held communication equipment.

### Applications

- Cellular phones, Smart Phones, PDA
- Battery-powered equipment
- Laptop, notebook and palmtop computers
- Consumer/personal electronics

### Features

- Input voltage range -----2.0V to 5.5V
- High output accuracy-----1.0% accuracy
- Low dropout-----210mV@150mA (3.3V Output type)
- Stability with ceramic output capacitors
- Supply Current-----Typ. 36uA
- Excellent Load regulation-----Typ. 30mV
- Built-in Fold Back Protection Circuit -----Typ. 40mA@Short mode
- Stability with ceramic output capacitors----- $C_{IN}=C_{OUT}=0.47\mu F$
- TTL-Logic-compatible ON/OFF control

### Packages

- KIC3213MF\*\* Series : UDFN1010-4
- KIC3213T\*\* Series : TSV

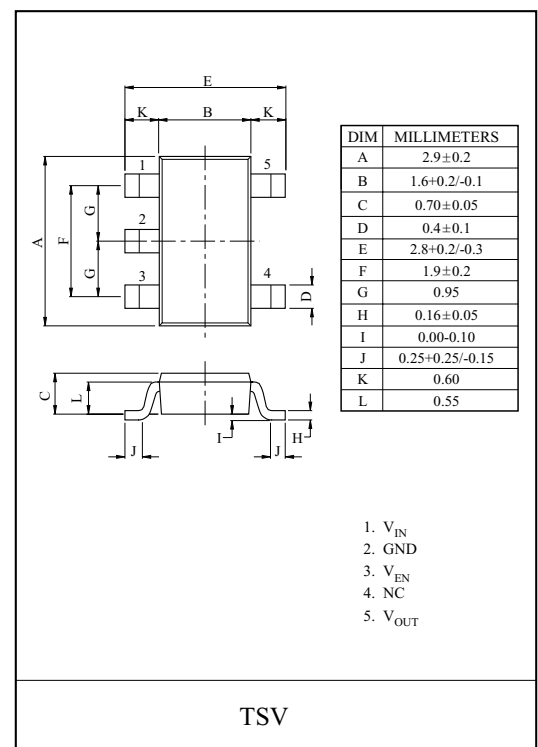
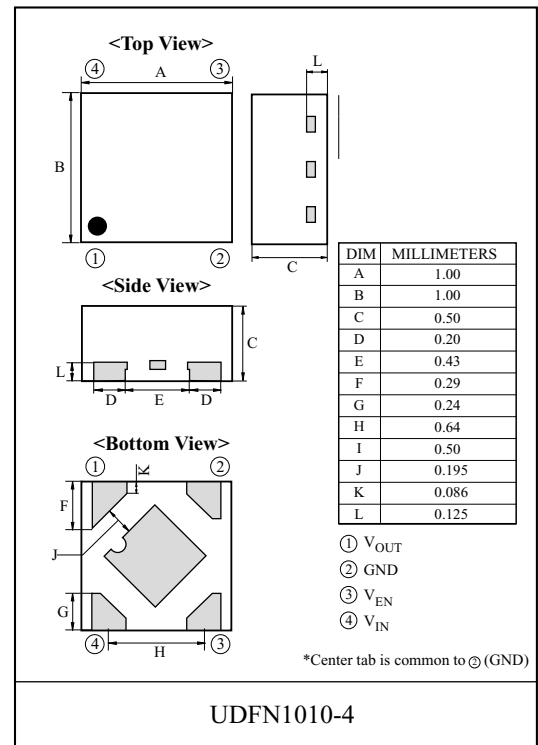

# KIC3213MF/T12~33

## Block Diagram

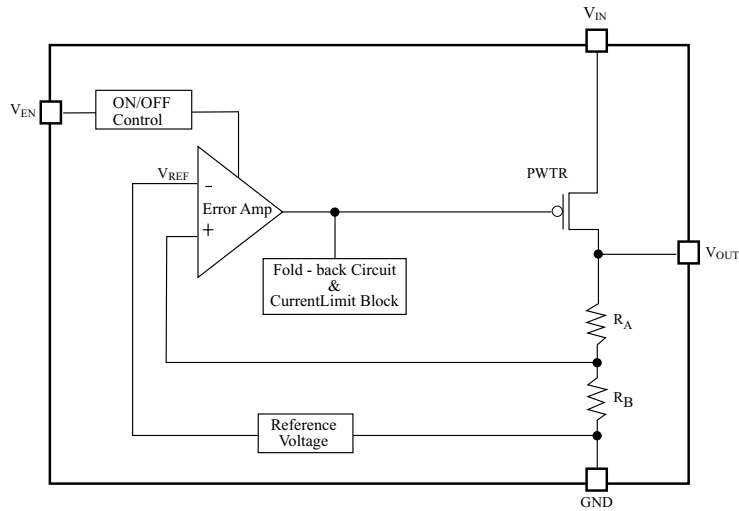

## Application Circuit

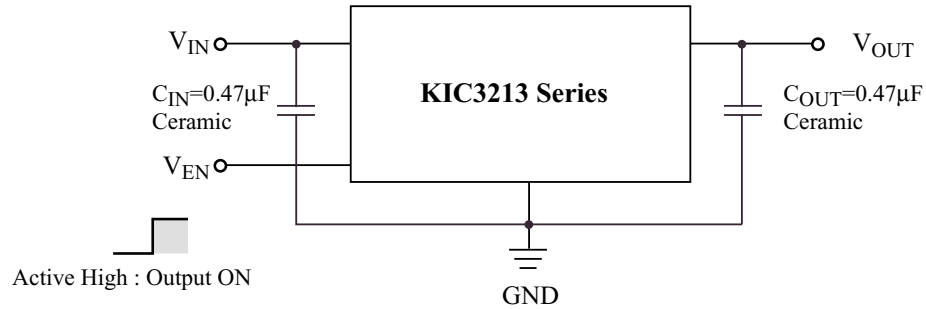

Stability with ceramic output capacitors  $C_{IN} = C_{OUT} = 0.47 \mu F$   
 Recommended  $V_{EN}$  Operating Range  $V_{IN} \geq V_{EN}$

## Selection Guide

The output voltage, package type for the ICs can be selected at the user's request.  
 The selection can be made with designating the part number as shown below;

**KIC3213**       ← Part Number  
           a          b          c

Code	Contents
a	Item name KIC3213 : 150mA CMOS LDO
b	Designation of Package Type : <b>MF : UDFN1010-4</b> <b>T : TSV</b>
c	Setting Output Voltage ( $V_{OUT}$ ) : Stepwise setting with a step of 0.1V in the range of 1.2V to 3.3V is possible.

# KIC3213MF/T12~33

## Pin Description

### TSV Package

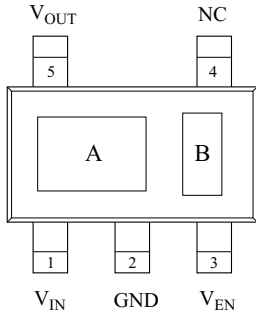

Pin No.	Symbol	Description
1	$V_{IN}$	Supply Input.
2	GND	Ground Pin.
3	$V_{EN}$	Enable/Shutdown (Input) : CMOS compatible input. Logic High : enable, logic low=shutdown. Do not leave open.
4	NC	No Connection.
5	$V_{OUT}$	Regulator Output.

Code	Contents
A	Device code & Series
B	Lot No.

### UDFN1010-4 Package

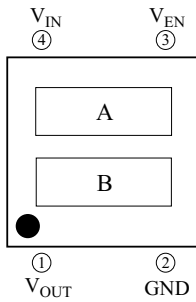

Pin No.	Symbol	Pin Description
1	$V_{OUT}$	Regulator Output.
2	GND	Ground Pin.
3	$V_{EN}$	Enable/Shutdown (Input) : CMOS compatible input. Logic High : enable, logic low=shutdown. Do not leave open.
4	$V_{IN}$	Supply Input.

Code	Contents
A	Device code & Series
B	Lot No.

## Line up

Output Voltage	UDFN1010-4 Package		TSV Package		Output Voltage	UDFN1010-4 Package		TSV Package	
	Item	Marking	Item	Marking		Item	Marking	Item	Marking
1.2V	KIC3213MF12	9A	KIC3213T12	39A	2.3V	KIC3213MF23	9L	KIC3213T23	39L
1.3V	KIC3213MF13	9B	KIC3213T13	39B	2.4V	KIC3213MF24	9M	KIC3213T24	39M
1.4V	KIC3213MF14	9C	KIC3213T14	39C	2.5V	KIC3213MF25	9N	KIC3213T25	39N
1.5V	KIC3213MF15	9D	KIC3213T15	39D	2.6V	KIC3213MF26	9O	KIC3213T26	39O
1.6V	KIC3213MF16	9E	KIC3213T16	39E	2.7V	KIC3213MF27	9P	KIC3213T27	39P
1.7V	KIC3213MF17	9F	KIC3213T17	39F	2.8V	KIC3213MF28	9Q	KIC3213T28	39Q
1.8V	KIC3213MF18	9G	KIC3213T18	39G	2.9V	KIC3213MF29	9R	KIC3213T29	39R
1.9V	KIC3213MF19	9H	KIC3213T19	39H	3.0V	KIC3213MF30	9S	KIC3213T30	39S
2.0V	KIC3213MF20	9I	KIC3213T20	39I	3.1V	KIC3213MF31	9T	KIC3213T31	39T
2.1V	KIC3213MF21	9J	KIC3213T21	39J	3.2V	KIC3213MF32	9U	KIC3213T32	39U
2.2V	KIC3213MF22	9K	KIC3213T22	39K	3.3V	KIC3213MF33	9V	KIC3213T33	39V

# KIC3213MF/T12~33

## Absolute Maximum Ratings

Characteristics		Symbol	Rating	Units
Input Voltage		$V_{IN}$	5.5	V
Output Current		$I_{OUT}$	150	mA
Power Dissipation	UDFN1010-4	$P_D$	400 (Note 1)	mW
	TSV		900 (Note 2)	
Operating Junction Temperature		$T_{j(opr)}$	-40~125	°C
Storage Temperature		$T_{STG}$	-55~150	°C

Note 1) Package Mounted on FR-4 PCB board (160mm×1.6mm)

Note 2) Package Mounted on FR-4 PCB board (600mm×0.8mm)

## Electrical Characteristics

( $V_{IN}$  = Set  $V_{OUT} + 1V$  for  $V_{OUT}$  options greater than 1.5V,  $V_{IN}=2.5V$  for  $V_{OUT} \leq 1.5V$ )

$I_{OUT}=1mA$ ,  $V_{EN}=V_{IN}$ ,  $T_A=25^\circ C$ ,  $C_{IN}=0.47\mu F$ ,  $C_{OUT}=0.47\mu F$ , unless otherwise stated)

Symbol	Parameter	Conditions	Min	Typ	Max	Units
$V_{IN}$	Input Voltage	-	2.0	-	5.5	V
$I_{OUT}$	Output Current	-	150	-	-	mA
$V_{OUT}$	Output Voltage	$V_{OUT} \geq 1.5V$	x 0.99	-	x 1.01	V
		$V_{OUT} \leq 1.5V$	-20	-	+20	mV
$\Delta V_{OUT} / \Delta V_{IN}$	Line Regulation	Set $V_{OUT} + 0.5V \leq V_{IN} \leq 5.5V$	-	0.02	0.1	% / V
$\Delta V_{OUT} / \Delta I_{OUT}$	Load Regulation	$1mA \leq I_{OUT} \leq 150mA$	-	30	50	mV
$V_D$	Dropout Voltage	$1.2V \leq V_{OUT} \leq 1.5V$	-	0.50	0.62	V
		$1.5V \leq V_{OUT} \leq 1.7V$	-	0.38	0.47	V
		$1.7V \leq V_{OUT} \leq 2.0V$	-	0.34	0.42	V
		$2.0V \leq V_{OUT} \leq 2.5V$	-	0.28	0.36	V
		$2.5V \leq V_{OUT} \leq 2.8V$	-	0.22	0.30	V
		$2.8V \leq V_{OUT} \leq 3.3V$	-	0.21	0.27	V
$I_{GND}$	Ground Pin Current	$I_{OUT} = 0mA$	-	36	50	$\mu A$
$I_Q$	Quiescent Current	$V_{EN} = 0V$ (Shutdown)	-	0.1	1.0	$\mu A$
$\Delta V_{OUT} / \Delta T_a$	Output Voltage Temperature Coefficient	$-40^\circ C \leq T_{OPR} \leq 85^\circ C$	-	$\pm 100$	-	ppm / °C
$I_{SC}$	Short Current Limit	$V_{OUT} = 0V$	-	40	-	mA
$V_{EN(ON)}$	Output Control Voltage (ON-State)	-	1.1	-	5.5	V
$V_{EN(OFF)}$	Output Control Voltage (OFF-State)	-	0	-	0.3	V
PSRR	Power Supply Ripple Rejection	f=1kHz, Ripple 0.2Vp-p $V_{IN} = \text{Set } V_{OUT} + 1V, I_{OUT} = 30mA$ (In case that $V_{OUT} \leq 1.5V, V_{IN} = 2.5V$ )	-	60	-	dB

# KIC3213MF/T12~33

## Typical Characteristics

1) Output Voltage vs. Input Voltage ( $C_{IN} = C_{OUT} = 0.47\mu F$ ,  $T_{OPR} = 25^\circ C$ )

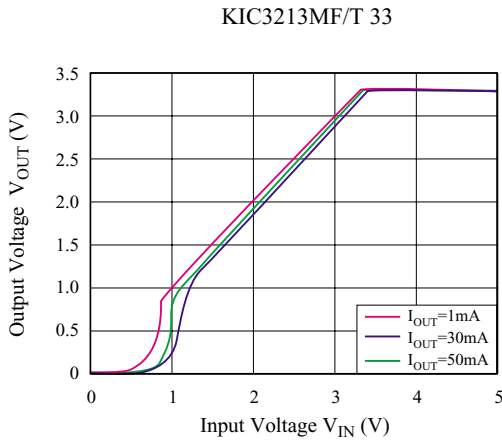
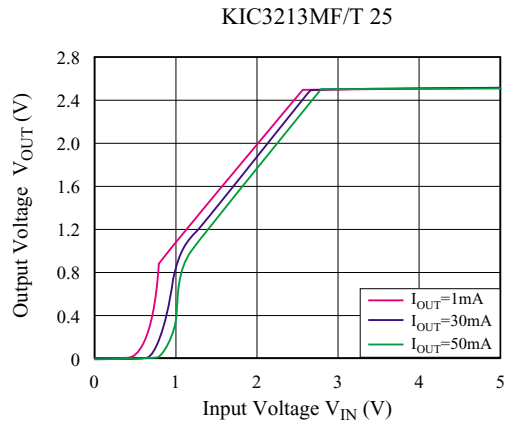
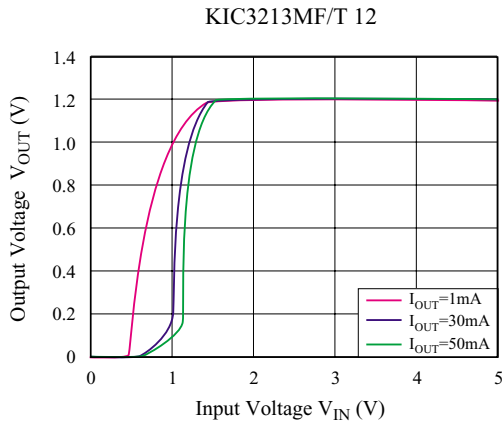

2) Ground Current vs. Input Voltage ( $C_{IN} = C_{OUT} = 0.47\mu F$ ,  $T_{OPR} = 25^\circ C$ )

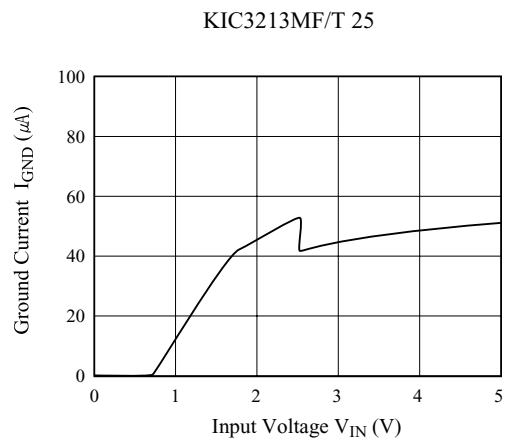
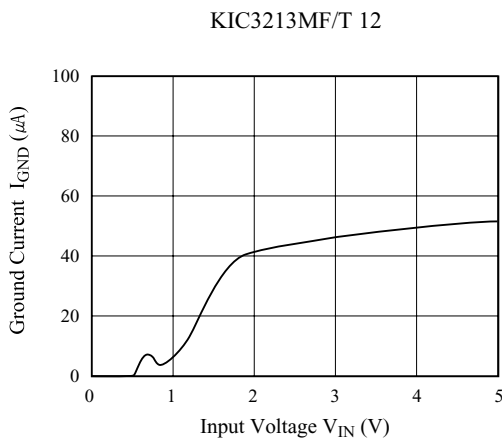

# KIC3213MF/T12~33

KIC3213MF/T 33

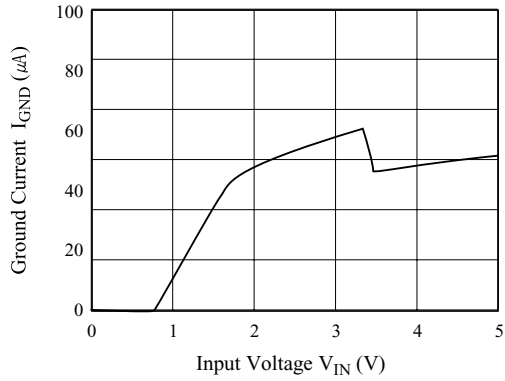

3) Output Voltage vs. Temperature

(C<sub>IN</sub> = C<sub>OUT</sub> = 0.47 μF, I<sub>OUT</sub> = 1 mA)

KIC3213MF/T 33

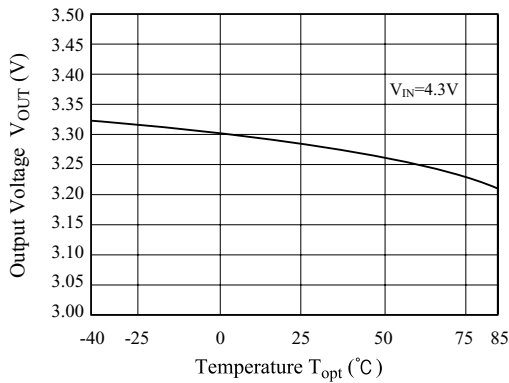

4) Ground Current vs. Temperature

(C<sub>IN</sub> = C<sub>OUT</sub> = 0.47 μF, I<sub>OUT</sub> = 0 A)

KIC3213MF/T 33

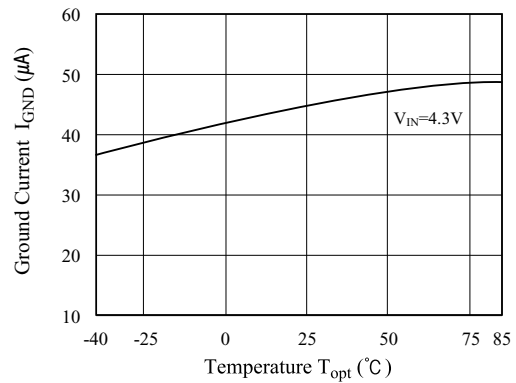

5) Input Transient Response

(I<sub>OUT</sub> = 30 mA, t<sub>r</sub> = t<sub>f</sub> = 5 μs, T<sub>OPR</sub> = 25 °C)

KIC3213MF/T 33

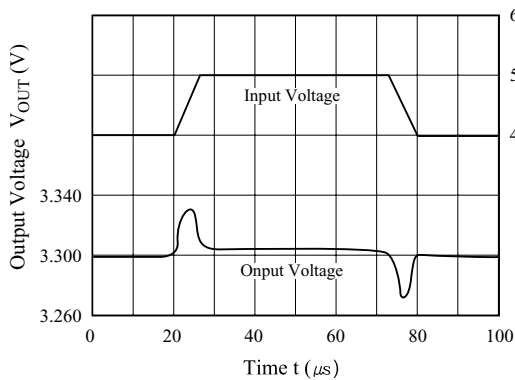

6) Load Transient Response

(C<sub>IN</sub> = C<sub>OUT</sub> = 0.47 μF, T<sub>OPR</sub> = 25 °C)

KIC3213MF/T 33

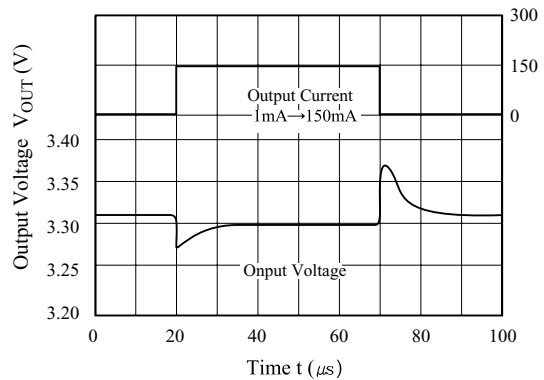

# KIC3213MF/T12~33

7) Turn On Speed With CE Pin ( $C_{IN} = C_{OUT} = 0.47\mu F$ ,  $T_{OPR} = 25^\circ C$ )

KIC3213MF/T 33

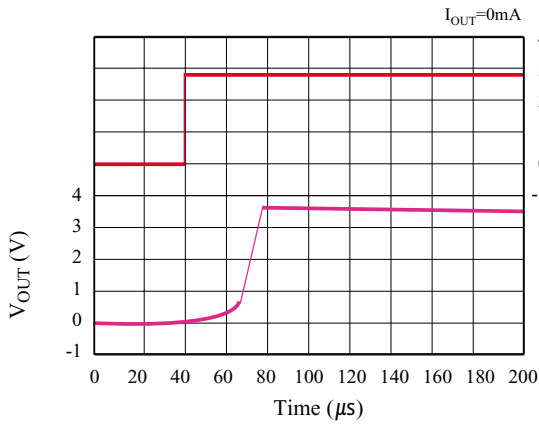

KIC3213MF/T 33

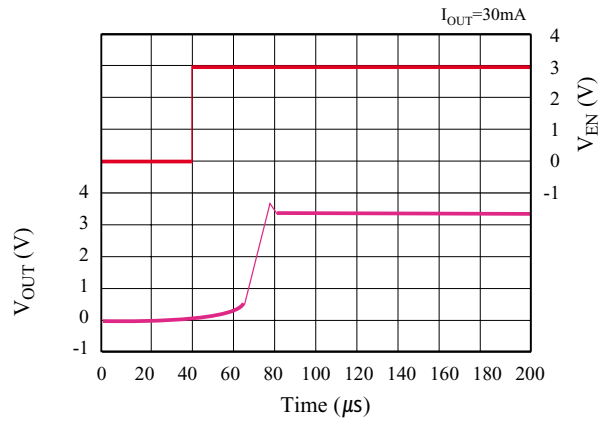

KIC3213MF/T 33

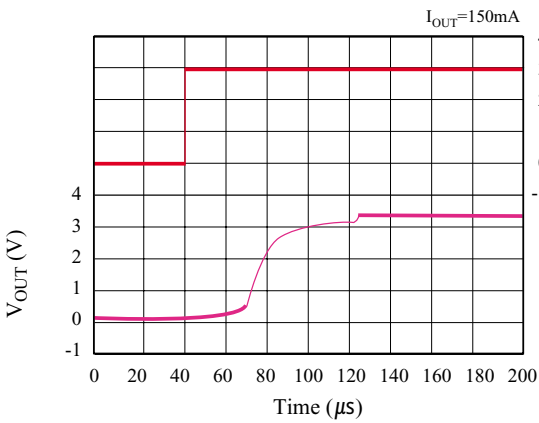

KIC3213MF/T 18

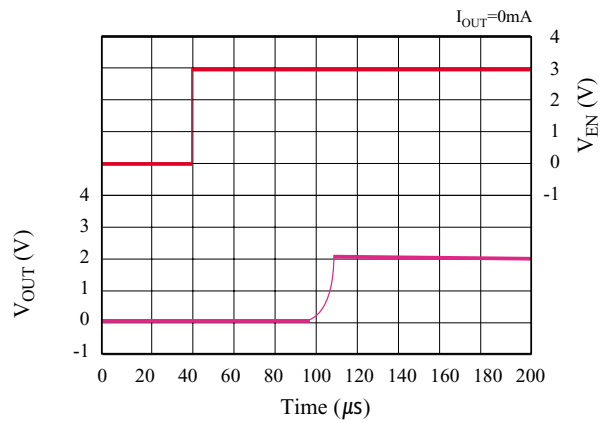

KIC3213MF/T 18

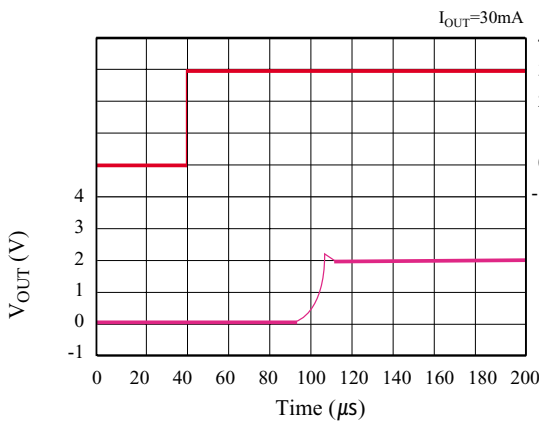

KIC3213MF/T 18

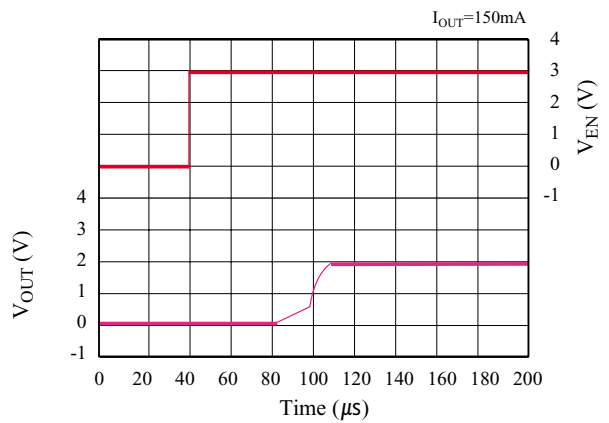

# KIC3213MF/T12~33

8) Turn Off Speed With  $V_{EN}$  Pin ( $C_{IN} = C_{OUT} = 0.47\mu F$ ,  $T_{OPR} = 25^\circ C$ )

