

Transient Voltage Suppressors Array for ESD Protection

ESD05V14T-3L

Description

The ESD05V14T-3L is designed to protect voltage sensitive components from ESD and transient voltage events. Excellent clamping capability, low leakage, and fast response time, make these parts ideal for ESD protection on designs where board space is at a premium.

SOT-143

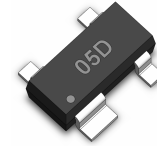

Feature

- u 100 Watts Peak Pulse Power per Line (tp=8/20μs)
- u Protects three unidirectional lines
- u Low clamping voltage
- u RoHS Compliant
- u IEC61000-4-2 (ESD) ±15kV (air), ±8kV (contact)
- u IEC61000-4-4 (EFT) 40A (5/50ns)
- u IEC61000-4-5 (Lightning) 5A (8/20μs)

Functional Diagram

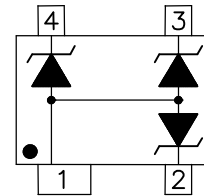

Applications

- u Portable Electronics
- u Microprocessor Based Equipment
- u Set-Top Box
- u Notebooks, Desktops, and Servers
- u Portable Instrumentation
- u Industrial Controls
- u Peripherals

Mechanical Characteristics

- u JEDEC SOT-143 Package
- u Molding Compound Flammability Rating : UL 94V-0
- u Weight 10.0 Milligrams (Approximate)
- u Quantity Per Reel : 3,000pcs
- u Reel Size : 7 inch
- u Lead Finish : Lead Free

Mechanical Characteristics

Symbol	Parameter	Value	Units
P _{PP}	Peak Pulse Power (tp=8/20μs waveform)	100	W
T _L	Lead Soldering Temperature	260 (10sec)	°C
T _{STG}	Storage Temperature Range	-55 to +150	°C
T _J	Operating Temperature Range	-55 to +150	°C
	IEC61000-4-2 (ESD)	Air Discharge ±15 Contact Discharge ±8	KV
	IEC61000-4-4 (EFT)	40	A
	IEC61000-4-5 (Lightning)	5	A

Transient Voltage Suppressors Array for ESD Protection

ESD05V14T-3L

Electrical Characteristics (@ 25°C Unless Otherwise Specified)

Part Number	Device Marking	V _{RWM} (V) (Max.)	V _B (V) (Min.)	I _T (mA)	V _C @1A (Max.)	V _C		I _R (μA) (Max.)	C (pF) (Typ.)
						(Max.)	(@A)		
ESD05V14T-3L	05D	5	6	1	9.8	15	5	1	30

Characteristic Curves

Fig1. 8/20μs Pulse Waveform

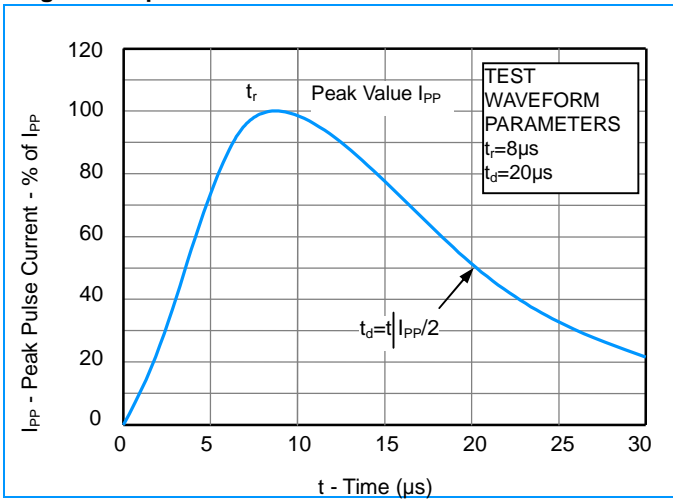

Fig2. ESD Pulse Waveform (according to IEC 61000-4-2)

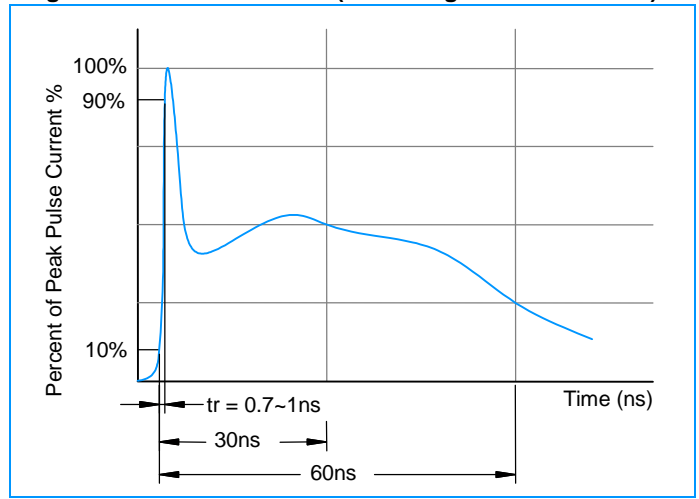

Fig3. ESD Clamping (+8KV Contac per IEC61000-4-2)

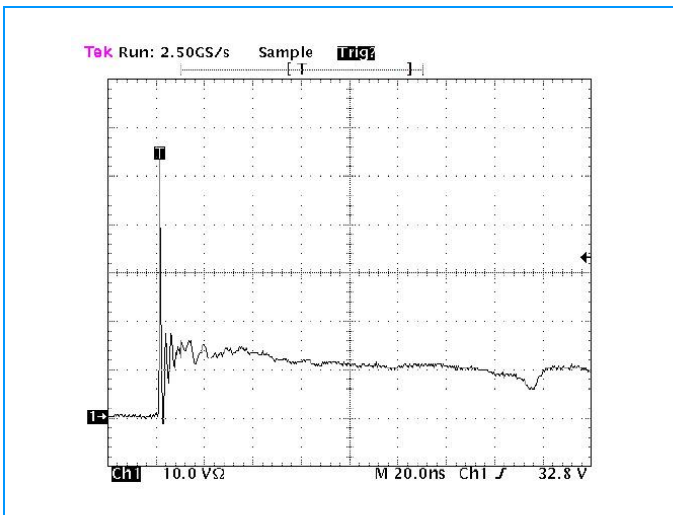
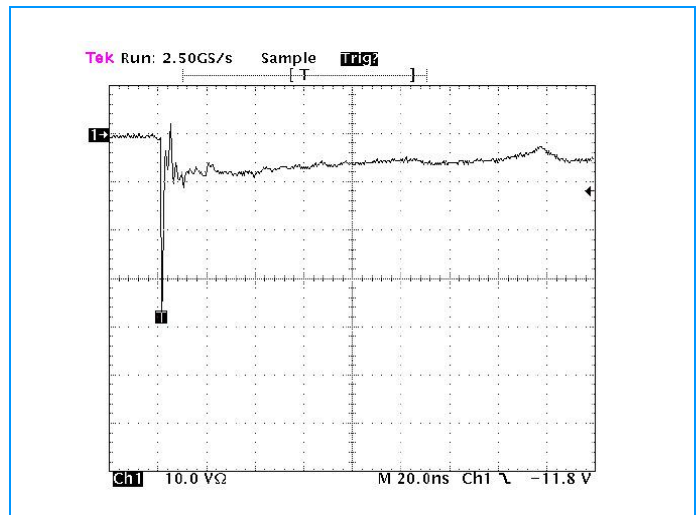

Fig4. ESD Clamping (-8KV Contac per IEC61000-4-2)



Transient Voltage Suppressors Array for ESD Protection

ESD05V14T-3L

SOT-143 Package Outline & Dimensions

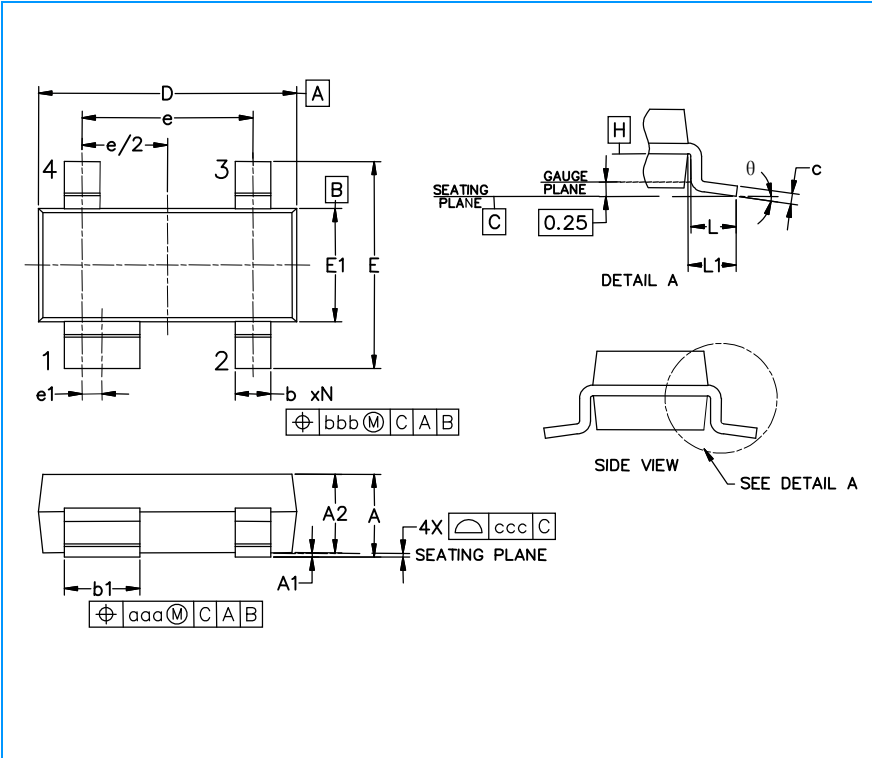

Symbol	Inches			Millimeters		
	Min.	Nom.	Max.	Min.	Nom.	Max.
A	0.031	-	0.048	0.80	-	1.22
A1	0.000	-	0.008	0.013	-	0.15
A2	0.020	0.035	0.042	0.75	0.90	1.07
b	0.011	-	0.020	0.30	-	0.51
b1	0.029	-	0.037	0.76	-	0.94
c	0.003	-	0.008	0.08	-	0.20
D	0.110	0.114	0.120	2.80	2.90	3.04
E	0.082	0.093	0.104	2.10	2.37	2.64
E1	0.047	0.051	0.055	1.20	1.30	1.40
e	0.075			1.92 BSC		
e1	0.008			0.20 BSC		
L	0.015	0.020	0.024	0.40	0.50	0.60
L1	(0.021)			(0.54)		
N	4			4		
θ	0°	-	8°	0°	-	8°
aaa	0.006			0.15		
bbb	0.008			0.20		
ccc	0.004			0.10		

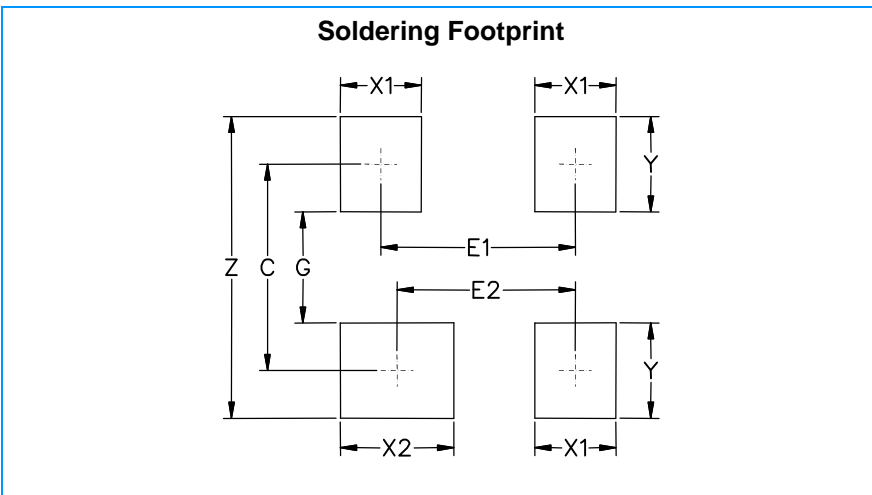

Symbol	Inches	Millimeters
C	(0.087)	(2.20)
E1	0.076	1.92
E2	0.068	1.72
G	0.031	0.80
X1	0.039	1.00
X2	0.047	1.20
Y	0.055	1.40
Z	0.141	3.60