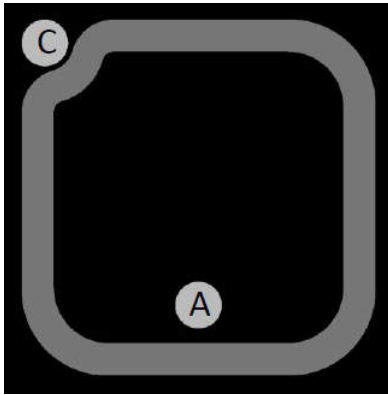


Silicon PIN Photodiode



DESCRIPTION

T337P6 is pin photodiode chip with 0.23 mm² sensitive area detecting visible and near infrared radiation. Anode and cathode are the bond pads on top.

GENERAL INFORMATION

The datasheet is based on Vishay optoelectronics sample testing under certain predetermined and assumed conditions, and is provided for illustration purpose only. Customers are encouraged to perform testing in actual proposed packaged and used conditions. Vishay optoelectronics die products are tested using Vishay optoelectronics based quality assurance procedures and are manufactured using Vishay optoelectronics established processes. Estimates such as those described and set forth in this datasheet for semiconductor die will vary depending on a number of packaging, handling, use, and other factors. Therefore sold die may not perform on an equivalent basis to standard package products.

FEATURES

- Package type: chip
- Package form: single chip
- Dimensions (L x W x H in mm): 0.67 x 0.67 x 0.28
- Radiant sensitive area (in mm²): 0.23
- Peak sensitivity wavelength: 970 nm
- High photo sensitivity
- Suitable for visible light and near infrared radiation
- Fast response times
- Angle of half sensitivity: $\phi = \pm 60^\circ$
- Material categorization: for definitions of compliance please see www.vishay.com/doc?99912



APPLICATIONS

- High speed photo detector

PRODUCT SUMMARY

COMPONENT	I_{ra} (μA)	ϕ (deg)	$\lambda_{0.5}$ (nm)
T337P6	2.3	± 60	610 to 1080

Note

- Test conditions see table "Basic Characteristics"

ORDERING INFORMATION

ORDERING CODE	PACKAGING	REMARKS	PACKAGE FORM
T337P6-SD-F	Wafer sawn on foil with disco frame	MOQ: 150 000 pcs	Chip

Note

- MOQ: minimum order quantity

ABSOLUTE MAXIMUM RATINGS ($T_{amb} = 25^\circ C$, unless otherwise specified)

PARAMETER	TEST CONDITION	SYMBOL	VALUE	UNIT
Reverse voltage		V_R	60	V
Junction temperature		T_j	100	$^\circ C$
Operating temperature range		T_{amb}	-40 to +100	$^\circ C$
Storage temperature range		T_{stg1}	-40 to +100	$^\circ C$
Storage temperature range on foil		T_{stg2}	-40 to +50	$^\circ C$

BASIC CHARACTERISTICS ($T_{amb} = 25\text{ }^{\circ}\text{C}$, unless otherwise specified)						
PARAMETER	TEST CONDITION	SYMBOL	MIN.	TYP.	MAX.	UNIT
Breakdown voltage	$I_R = 100\text{ }\mu\text{A}$, $E = 0$	$V_{(BR)}$	60			V
Reverse dark current	$V_R = 10\text{ V}$, $E = 0$	I_{ro}		< 1	3	nA
Diode capacitance	$V_R = 0\text{ V}$, $f = 1\text{ MHz}$, $E = 0$	C_D		3.3		pF
	$V_R = 3\text{ V}$, $f = 1\text{ MHz}$, $E = 0$	C_D		1.5		pF
Reverse light current	$E_e = 1\text{ mW/cm}^2$, $\lambda = 950\text{ nm}$, $V_R = 5\text{ V}$	I_{ra}		2.3		μA
	$E_e = 1\text{ mW/cm}^2$, $\lambda = 890\text{ nm}$, $V_R = 5\text{ V}$	I_{ra}		2.15		μA
Angle of half sensitivity		ϕ		± 60		deg
Wavelength of peak sensitivity		λ_p		970		nm
Range of spectral bandwidth		$\lambda_{0.5}$		610 to 1080		nm
Rise time	$V_R = 10\text{ V}$, $R_L = 1\text{ k}\Omega$, $\lambda = 950\text{ nm}$	t_r		3500		ns
Fall time	$V_R = 10\text{ V}$, $R_L = 1\text{ k}\Omega$, $\lambda = 950\text{ nm}$	t_f		820		ns
Rise time	$V_R = 10\text{ V}$, $R_L = 1\text{ k}\Omega$, $\lambda = 830\text{ nm}$	t_r		550		ns
Fall time	$V_R = 10\text{ V}$, $R_L = 1\text{ k}\Omega$, $\lambda = 830\text{ nm}$	t_f		100		ns

Notes

- The measurements are based on samples which are mounted on TO18-header without epoxy coating

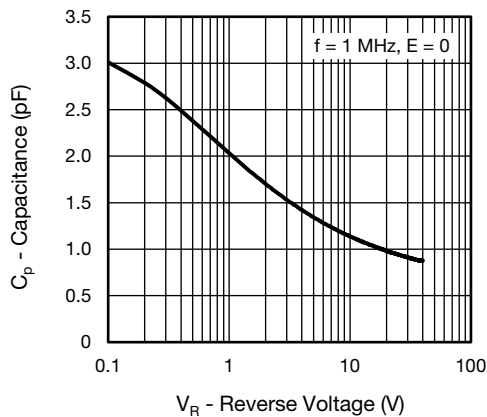
BASIC CHARACTERISTICS ($T_{amb} = 25\text{ }^{\circ}\text{C}$, unless otherwise specified)


Fig. 1 - Diode Capacitance vs. Reverse Voltage

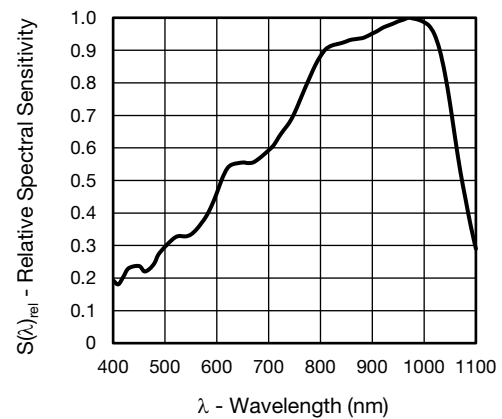
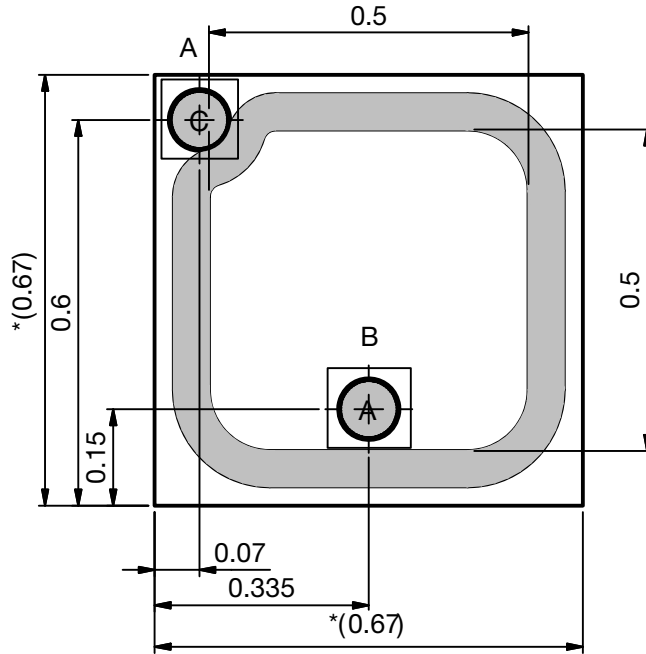
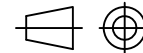
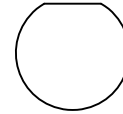


Fig. 2 - Relative Spectral Sensitivity vs. Wavelength without Epoxy Coating

DIMENSIONS in millimeters


Orientation of wafer flat



Technical drawings according to DIN specification.

 Opt. active area: 0.23 mm²

A: Anode

C: Cathode

Bonding area: A: Ø 80 µm

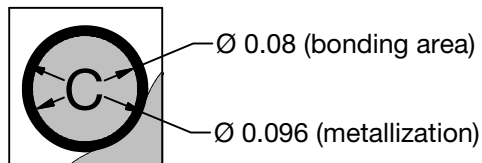
C: Ø 80 µm

Bonding restricted to this area in order to avoid damage of adjacent structures

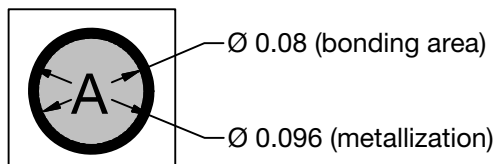
Thickness: 280 µm ± 15 µm

*only for information: dimension of sawn die under consideration of 30 µm saw kerf

A (200 : 1)



B (200 : 1)



Drawing-No.: 9.000-5123.01-4

Issue: 1; 08.08.2013

MECHANICAL DIMENSIONS					
PARAMETER	SYMBOL	MIN.	TYP.	MAX.	UNIT
Length of chip edge (x-direction)	L_x		0.67		mm
Length of chip edge (y-direction)	L_y		0.67		mm
Sensitive area	A_S		0.23		mm ²
Wafer diameter	D		150		mm
Die height	H	0.265	0.28	0.295	mm
Bond pad anode	Ø		0.08		mm
Bond pad cathode	Ø		0.08		mm



ADDITIONAL INFORMATION	
Frontside metallization, anode, cathode	AlSi
Backside	Electrically isolated
Dicing	Sawing
Die bonding technology	Epoxy bonding

Note

- All chips are checked in accordance with the Vishay Semiconductor, specification of visual inspection FVOV6870. The visual inspection shall be made in accordance with the “specification of visual inspection as referenced”. The visual inspection of chip backside is performed with stereo microscope with incident light and 40x to 80x magnification. The quality inspection (final visual inspection) is performed by production. An additional visual inspection step as special release procedure by QM is not installed.

HANDLING AND STORAGE CONDITIONS

- The hermetically sealed shipment lots shall be opened in temperature and moisture controlled cleanroom environment only. It is mandatory to follow the rules for disposition of material that can be hazardous for humans and environment.
- Product must be handled only at ESD safe workstations. Standard ESD precautions and safe work environments are as defined in MIL-HDBK-263.
- Singulated die are not to be handled with tweezers. A vacuum wand with non metallic ESD protected tip should be used.

PACKING

Chips are fixed on adhesive foil. Upon request the foils can be mounted on plastic frame or disco frame. For shipment, the wafers are arranged to stacks and hermetically sealed in plastic bags to ensure protection against environmental influence (humidity and contamination).

Use for recycling reliable operators only. We can help getting in touch with your nearest sales office. By agreement we will take back packing material, if it is sorted. You will have to bear the costs of transport. We will invoice you for any costs incurred for packing material that is returned unsorted or which we are not obliged to accept.



Disclaimer

ALL PRODUCT, PRODUCT SPECIFICATIONS AND DATA ARE SUBJECT TO CHANGE WITHOUT NOTICE TO IMPROVE RELIABILITY, FUNCTION OR DESIGN OR OTHERWISE.

Vishay Intertechnology, Inc., its affiliates, agents, and employees, and all persons acting on its or their behalf (collectively, "Vishay"), disclaim any and all liability for any errors, inaccuracies or incompleteness contained in any datasheet or in any other disclosure relating to any product.

Vishay makes no warranty, representation or guarantee regarding the suitability of the products for any particular purpose or the continuing production of any product. To the maximum extent permitted by applicable law, Vishay disclaims (i) any and all liability arising out of the application or use of any product, (ii) any and all liability, including without limitation special, consequential or incidental damages, and (iii) any and all implied warranties, including warranties of fitness for particular purpose, non-infringement and merchantability.

Statements regarding the suitability of products for certain types of applications are based on Vishay's knowledge of typical requirements that are often placed on Vishay products in generic applications. Such statements are not binding statements about the suitability of products for a particular application. It is the customer's responsibility to validate that a particular product with the properties described in the product specification is suitable for use in a particular application. Parameters provided in datasheets and / or specifications may vary in different applications and performance may vary over time. All operating parameters, including typical parameters, must be validated for each customer application by the customer's technical experts. Product specifications do not expand or otherwise modify Vishay's terms and conditions of purchase, including but not limited to the warranty expressed therein.

Except as expressly indicated in writing, Vishay products are not designed for use in medical, life-saving, or life-sustaining applications or for any other application in which the failure of the Vishay product could result in personal injury or death. Customers using or selling Vishay products not expressly indicated for use in such applications do so at their own risk. Please contact authorized Vishay personnel to obtain written terms and conditions regarding products designed for such applications.

No license, express or implied, by estoppel or otherwise, to any intellectual property rights is granted by this document or by any conduct of Vishay. Product names and markings noted herein may be trademarks of their respective owners.