

SPECIFICATION

- Part No. : **MA600.W.A.ABC.001**
- Product Name : MA600.W Spartan Screw-mount
 3in1 Combination Antenna – White Version
 GPS/GLONASS/GALILEO 1575~1602MHz
 Cellular – GSM/CDMA/HSPA/UMTS
 Dual band Wi-Fi 2.4GHz / 5.8GHz
- Feature : High performance outdoor antenna
 Custom cables and connectors available
 White Housing
 RoHS Compliant ✓



Mounted Profile



Mounted on White Roof



1. Introduction

The Spartan MA600.W antenna is a white, heavy-duty, fully IP67 waterproof external M2M antenna for use in telematics, transportation and remote monitoring applications.

The Spartan is unique in the market because it combines a 3in1 GPS/GLONASS/GALILEO, Cellular (2G and 3G) and Wi-Fi, heavy-duty antenna with high efficiency in a compact format. The antenna screws down permanently onto a roof or metal panel and can be pole or wall-mounted with a metal bracket. The white color is ideal for mounting on white truck roofs or cabs or industrial equipment.

For industries such as commercial vehicle telematics, remote monitoring, smart meter systems and construction equipment, the Spartan provides a robust, rugged antenna that is durable, even in extreme environments.

All while still maintaining 20dB isolation between antennas. It uses high-shielded PTFE dielectric ultra low-loss cables that maintain low attenuation at all frequency bands, with an average 0.3dB per meter (0.1dB per foot), compared to 0.7dB for RG58 and 1.2dB for RG174. Because of this, the Spartan maximizes chances of passing PTCRB and network approvals first time. The Spartan also has excellent GPS/GLONASS/GALILEO reception without need to attach to an external ground-plane due to coupling to its unique own metal base.

Note: for ground-isolation antennas use the MA605 version with Isolation Gaskets. Also available in Black.

2. Specification

GPS-GLONASS-GALILEO						
Centre Frequency	1575.42MHz / 1602MHz					
Bandwidth	10MHz					
Radiation Efficiency	50(without cable)					
Passive Gain @ Zenith	4.0 typ(with $\psi=140$ mm ground)					
VSWR	2					
Impedance	50 Ω					
DC Power Input Range	3 ~ 5V					
DC input	3.3V		4.0V		5.5V	
MHz	1575.42	1602	1575.42	1602	1575.42	1602
VSWR	2	2	2	2	2	2
LNA Gain	29.2	29	31	31	32.3	32
Noise Figure	3.1	3.1	3.2	3.2	3.4	3.4
Power Consumption	7.5	7.5	9.4	9.4	15	15
Band Attenuation	1520MHz: -20dB 1642MHz: -20dB		1520MHz: -20dB 1642MHz: -20dB		1520MHz: -20dB 1642MHz: -20dB	
Cable	3m RG-174 standard, fully customizable					
Connector	SMA(M) standard, fully customizable					

CELLULAR					
Frequency (GHz)	824~896	880~960	1710~1880	1850~1990	1710~2170
Peak Gain (dBi)	2.1	-0.2	2.9	3.0	5.1
Average (dBi)	-4.7	-7.5	-2.7	-3.1	-3.1
Efficiency	35%	20%	51%	49%	49%
Impedance	50 Ω				
Polarization	Linear				
Radiation Pattern	Omnidirectional				
Cable	3m CFD200 standard, fully customizable				
Connector	SMA(M) standard, fully customizable				

Wi-Fi				
Frequency (GHz)	2.4~2.5	4.7~5.0	5.0~5.4	5.4~5.9
Peak Gain (dBi)	2.1	2.9	3.8	2.8
Average Gain (dBi)	-2.3	-3.6	-3.3	-3.8
Efficiency	60%	44%	46%	42%
VSWR	<=1.6:1			
Impedance	50Ω			
Polarization	Linear			
Radiation Pattern	Omni			
Cable	3m CFD200 standard, fully customizable			
Connector	SMA(M) standard, standard, fully customizable			
MECHANICAL				
Dimensions	Profile 39.5mm x Diameter 145.6mm			
Casing	UV resistant PVC			
Base and thread	Nickel Plated Zinc			
Thread diameter	30mm			
Waterproof	IP67			
ENVIRONMENTAL				
Temperature Range	-40°C to 85°C			
Humidity	Non-condensing 65°C 95% RH			

•All measurements are done in free space with standard cables

3. GPS/GLONASS/GALILEO Antenna Characteristics

3.1 Block diagram

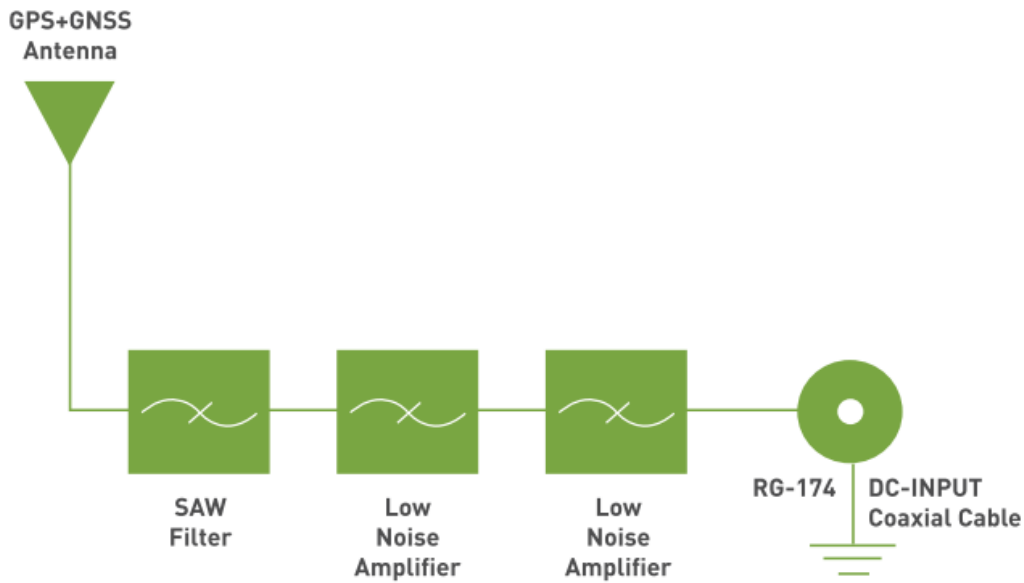

3.2 Return Loss

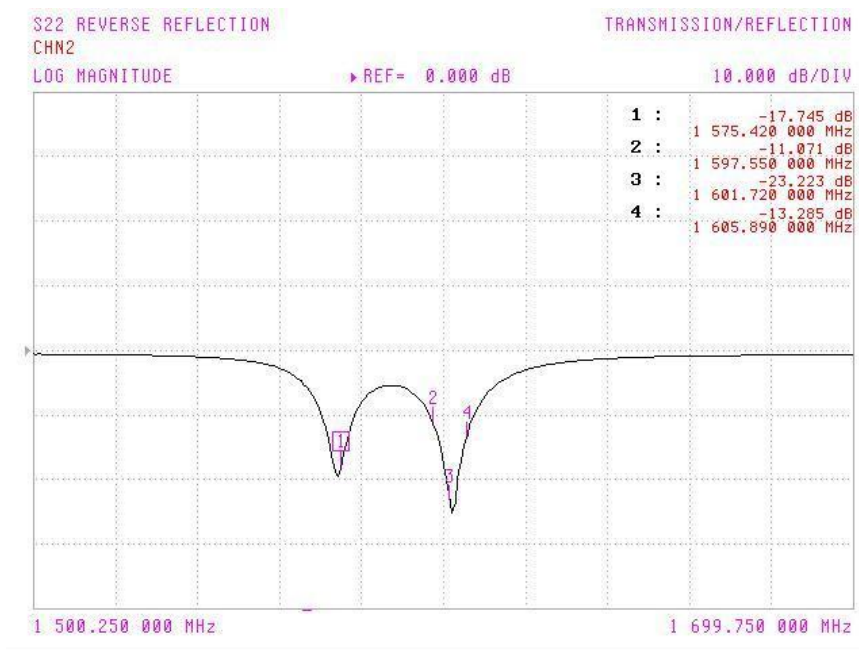

3.3 GPS/GLONASS/GALILEO Antenna Radiation Pattern

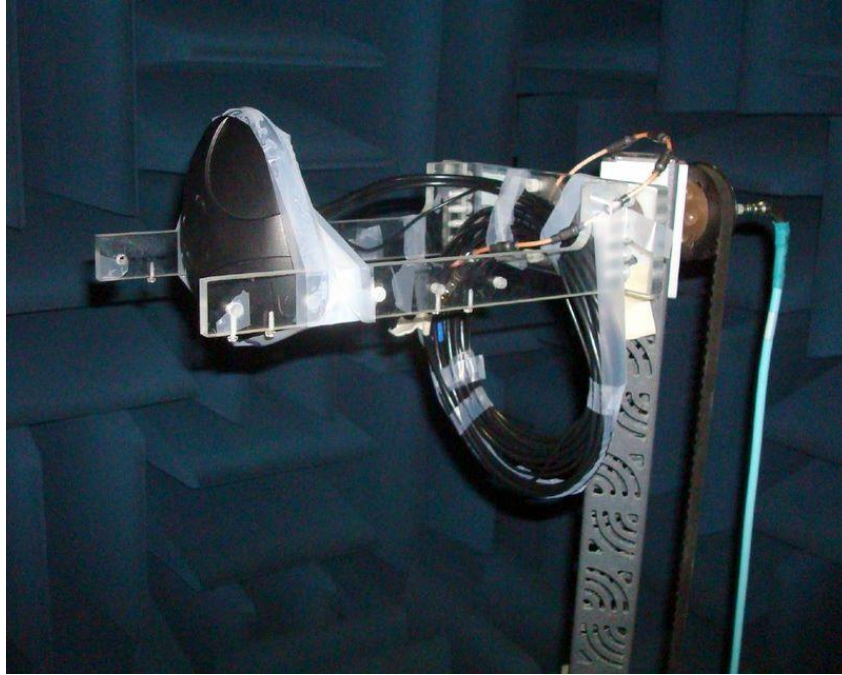

MA.600 tested in CTIA approved 3D chamber

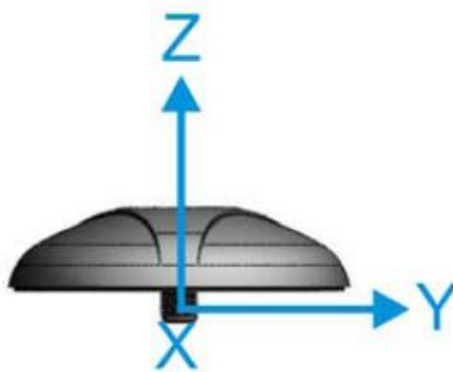

XYZ co-ordinate for reference.



3.4 Radiation Pattern

XZ Plane Free Space @1575.42MHz

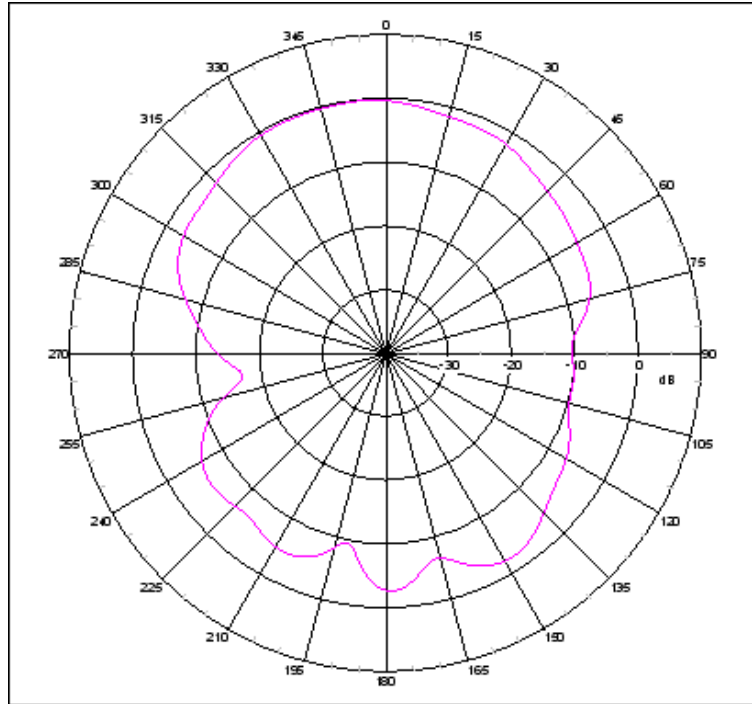

YZ Plane Free Space @1575.42MHz

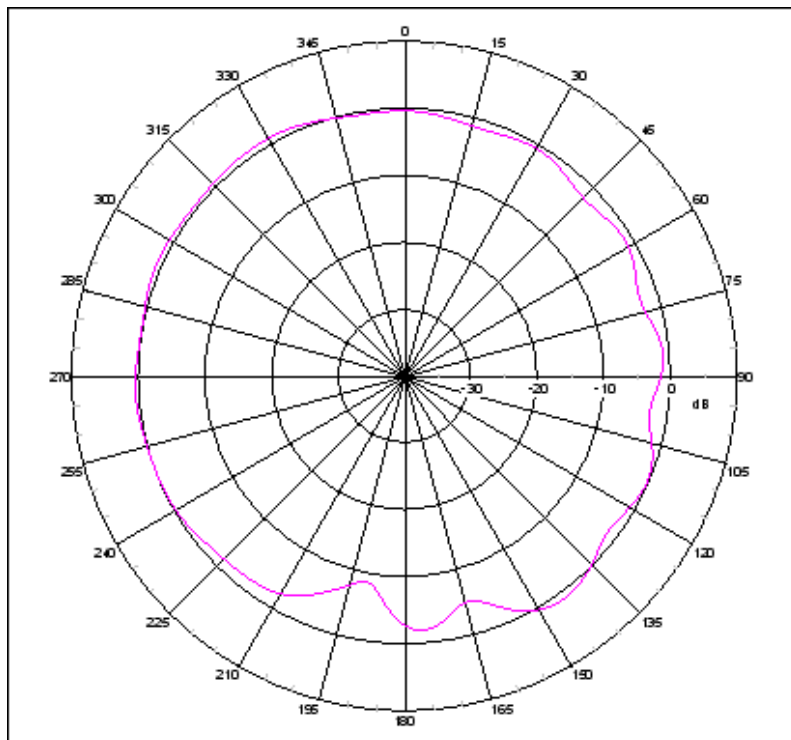



XZ Plane Free Space @1602MHz

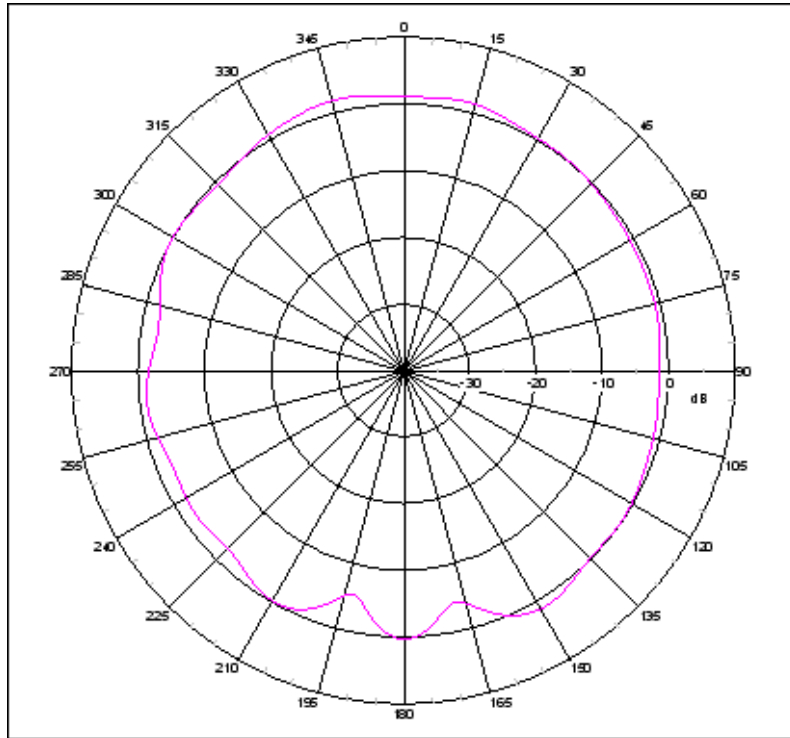

YZ Plane Free Space @1602MHz

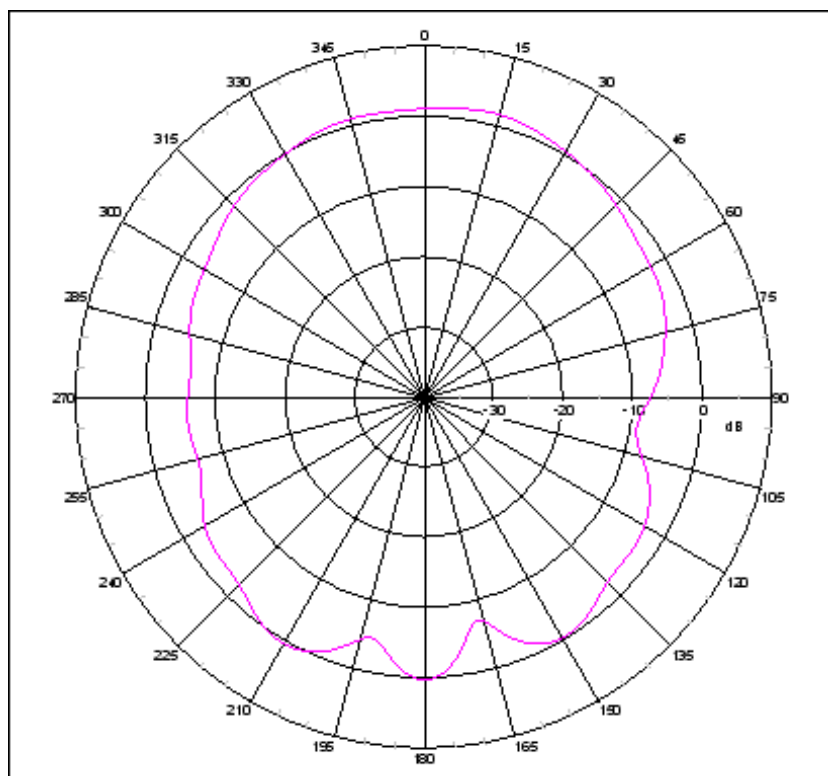

3.5 GPS/GLONASS/GALILEO LNA

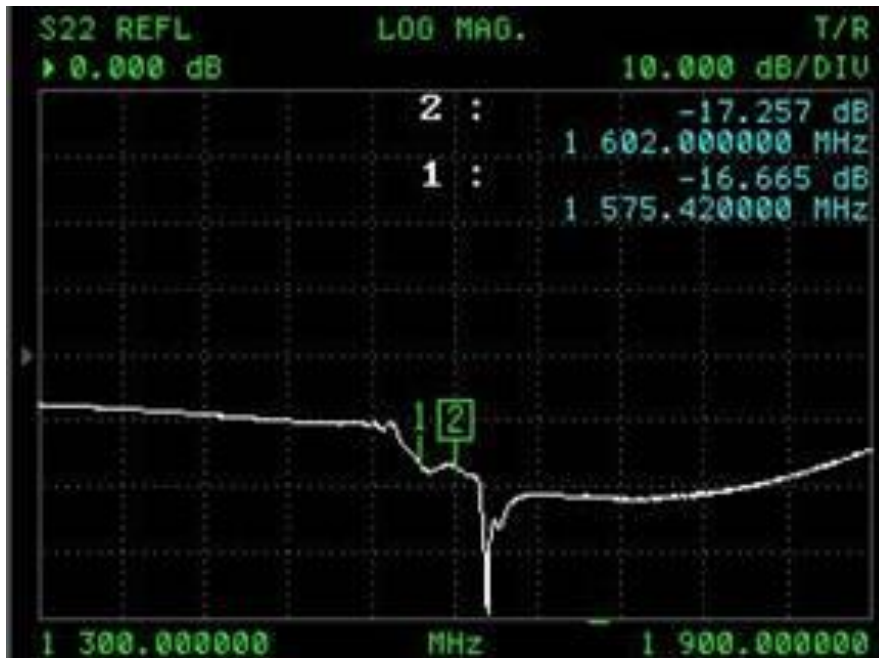
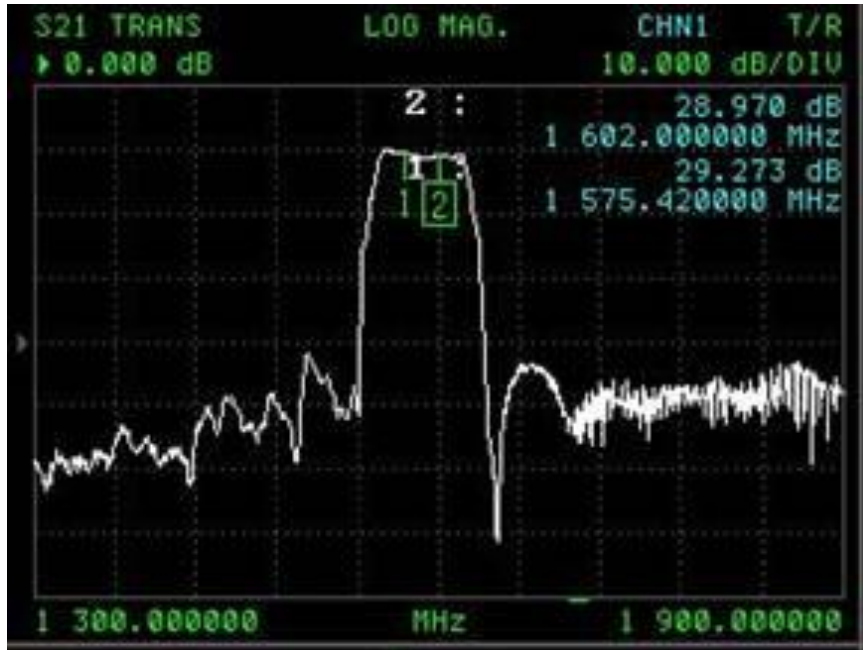

4. Cellular Antenna Characteristics

4.1 Return Loss

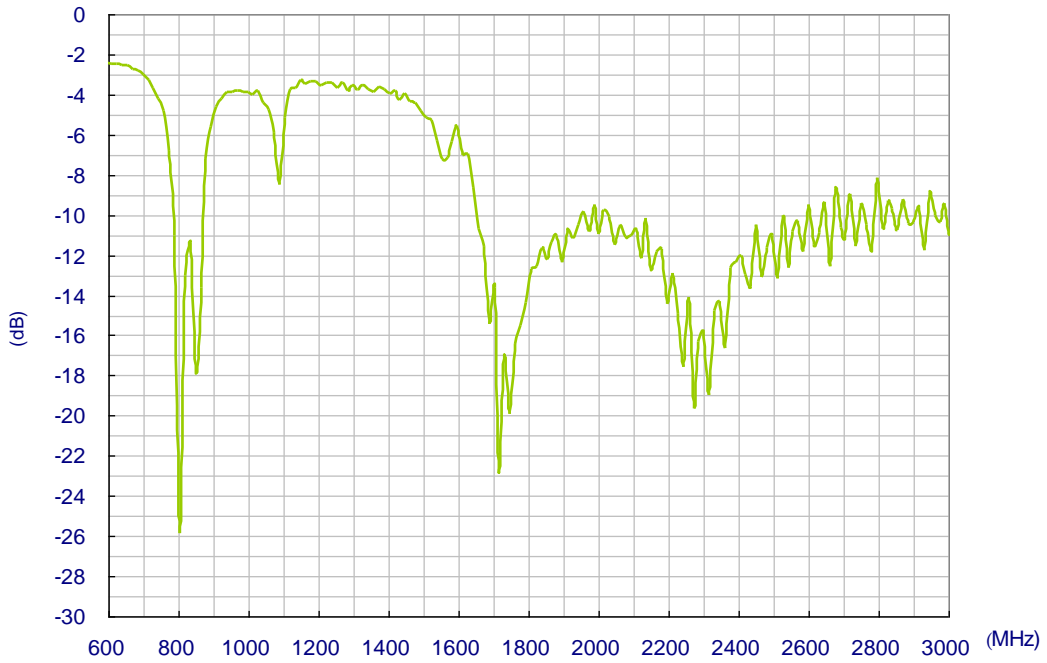

4.2 VSWR

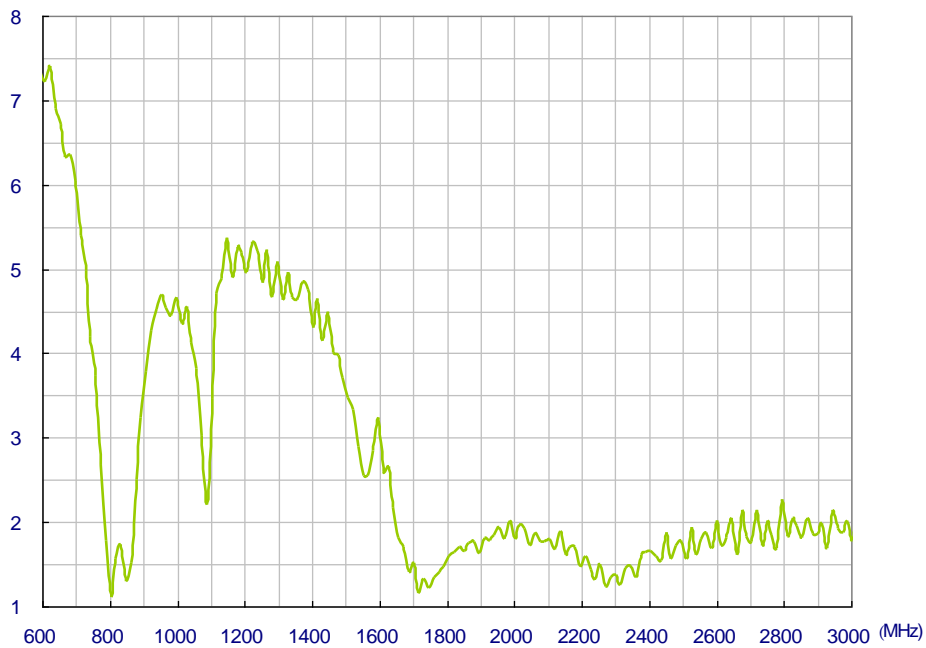

4.3 Cellular Antenna Efficiency

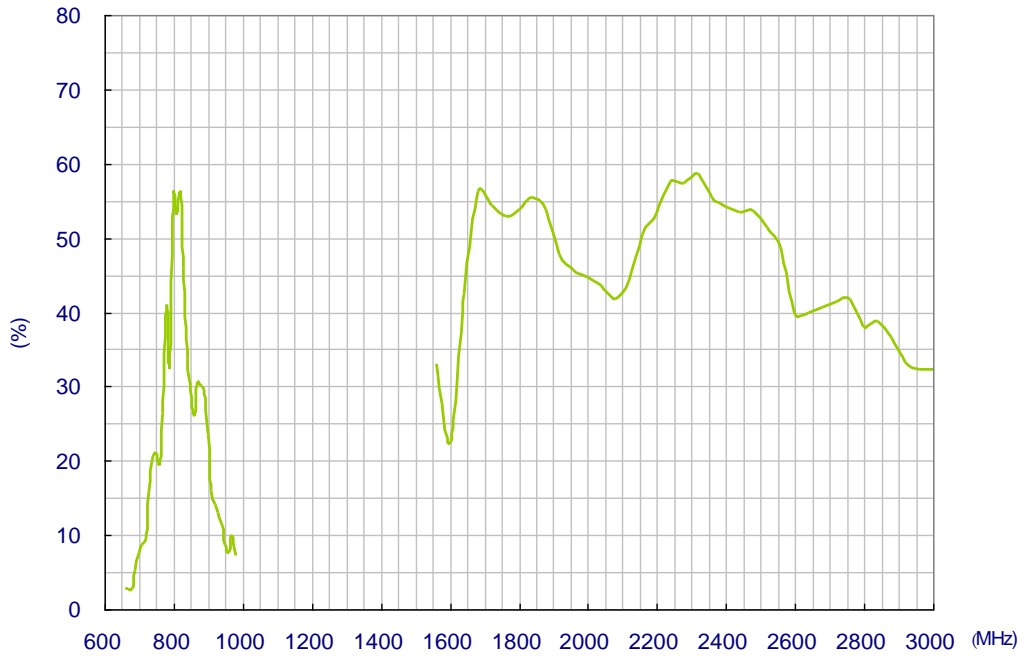

4.4 Cellular Antenna Peak Gain

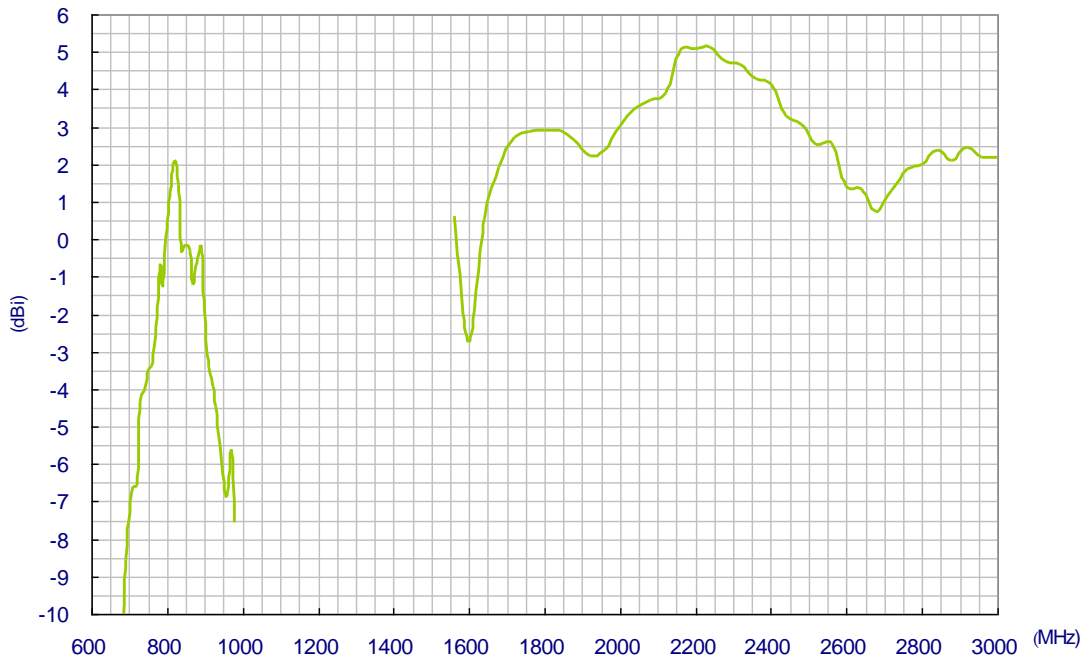

4.5 Cellular Antenna 3D Average Gain

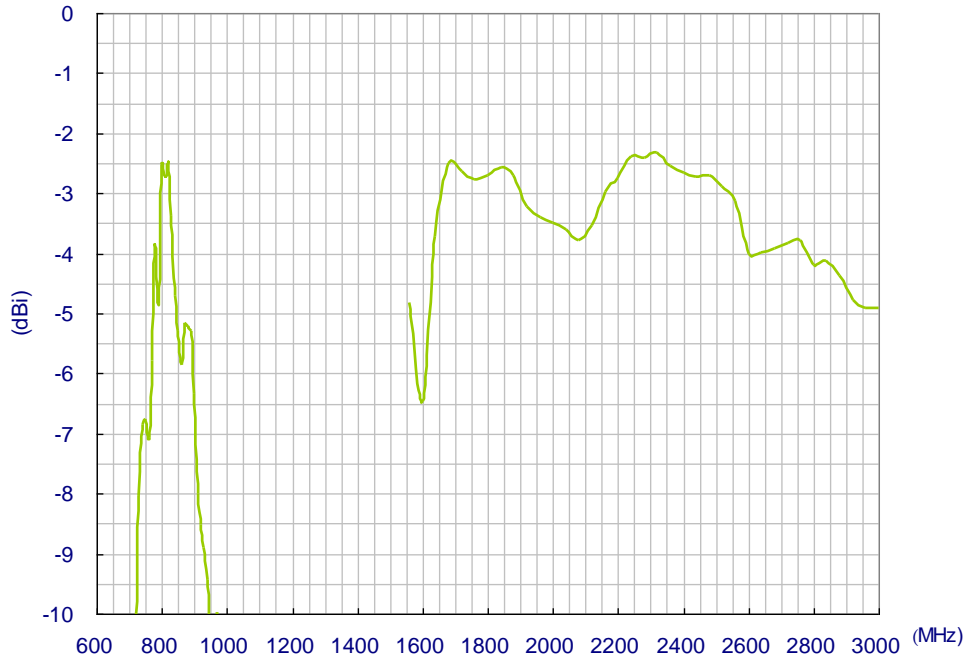

5. Cellular Antenna Radiation Pattern

5.1 XY Plane

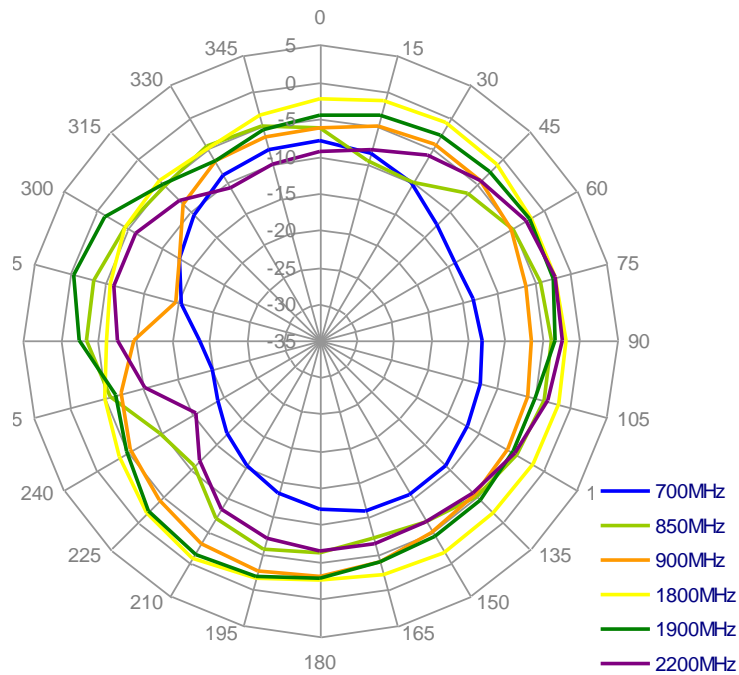

5.2 XZ Plane

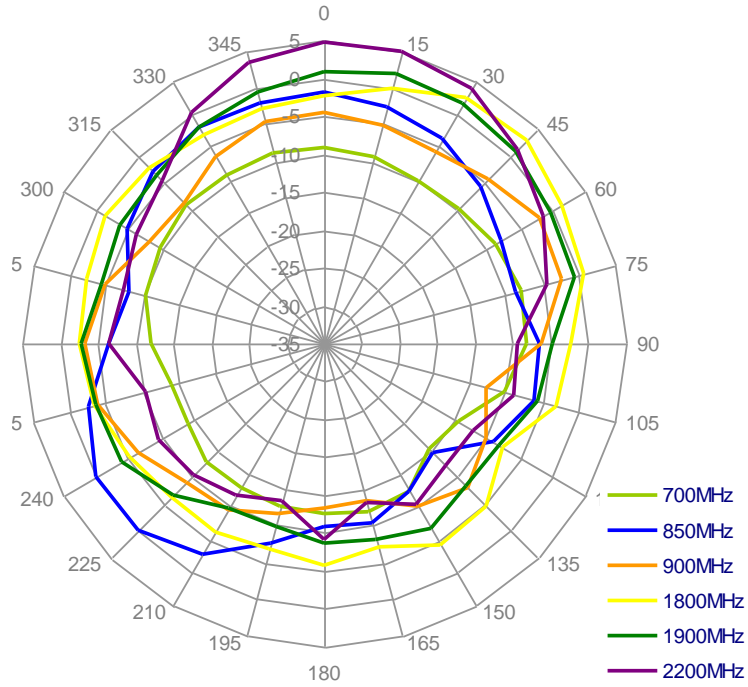

6. 2.4/5.8GHz Antenna Characteristics

6.1 S11 Return Loss

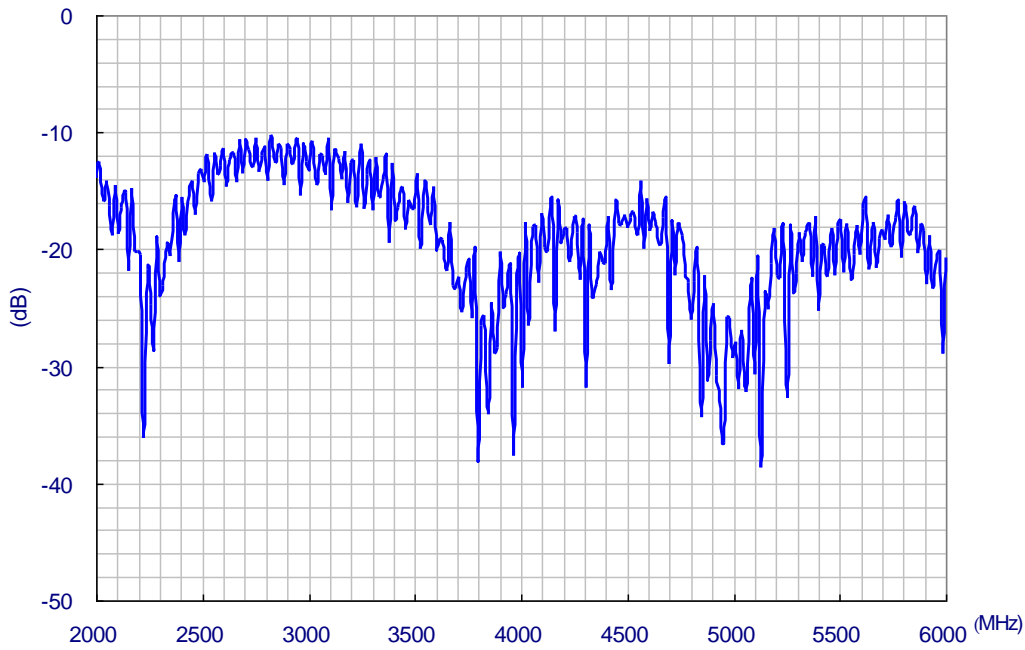

6.2 VSWR

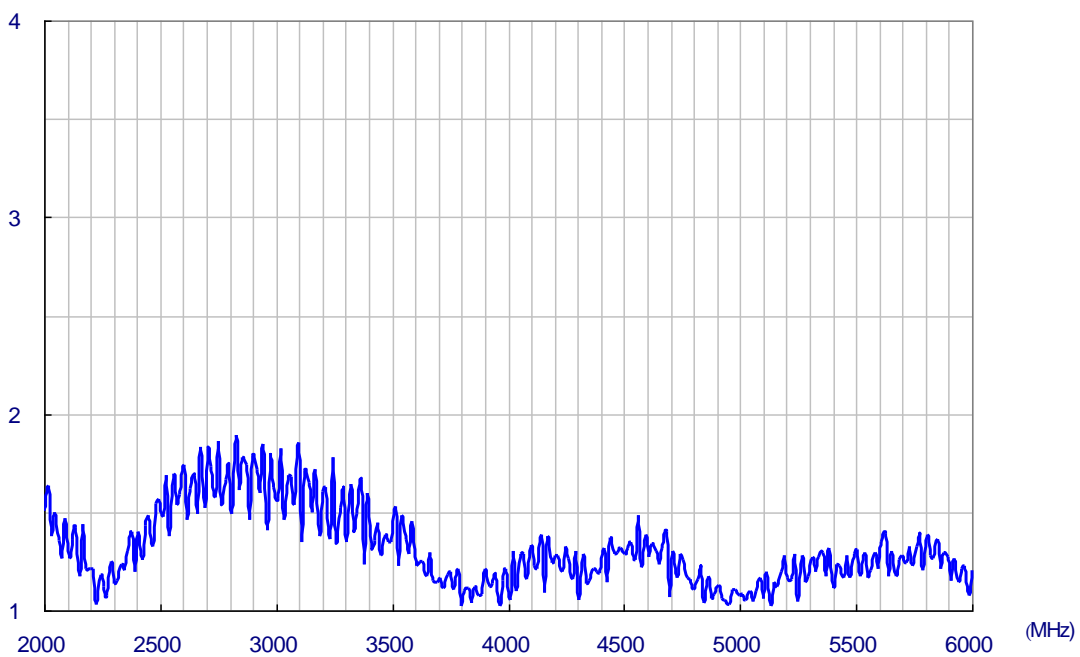

6.3 2.4/5.8GHz Antenna Efficiency

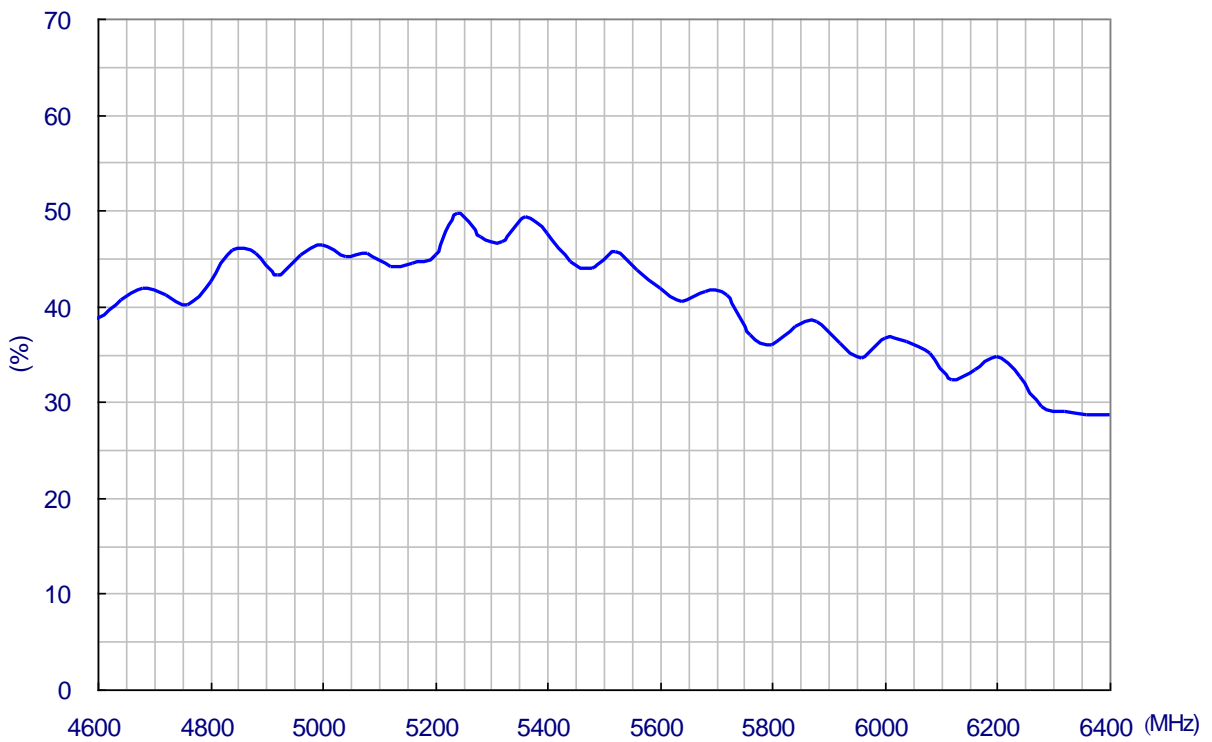
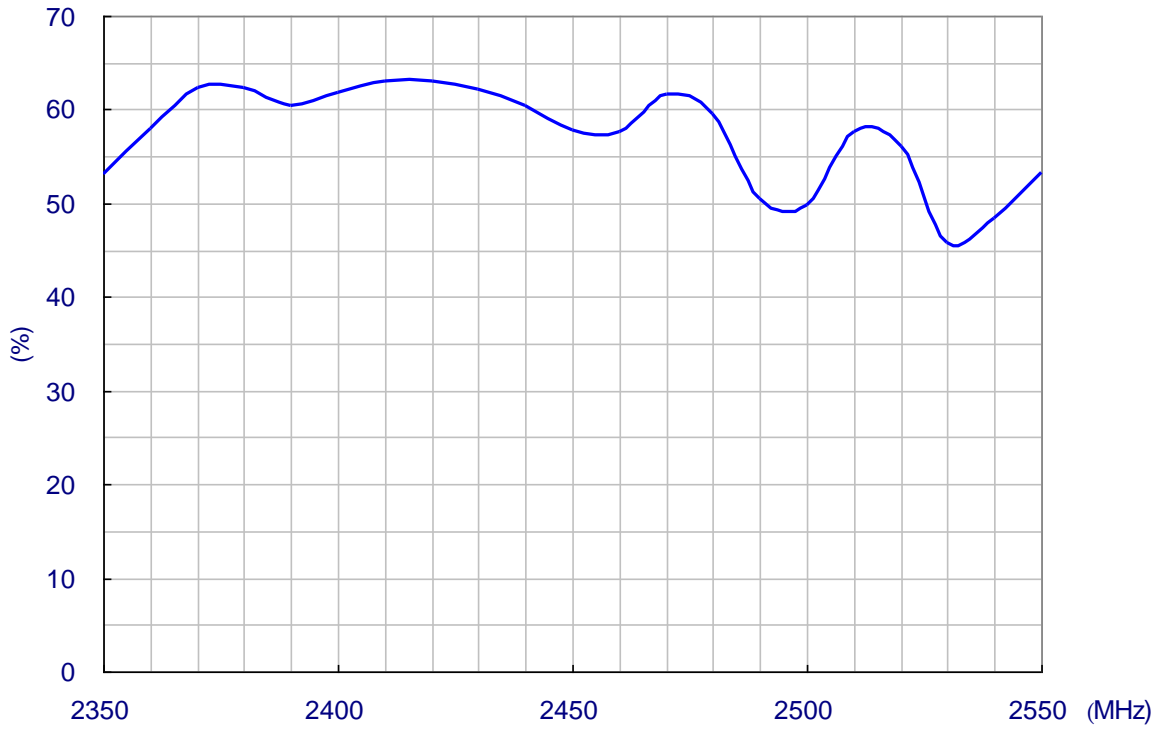

6.4 2.4/5.8GHz Antenna Peak Gain

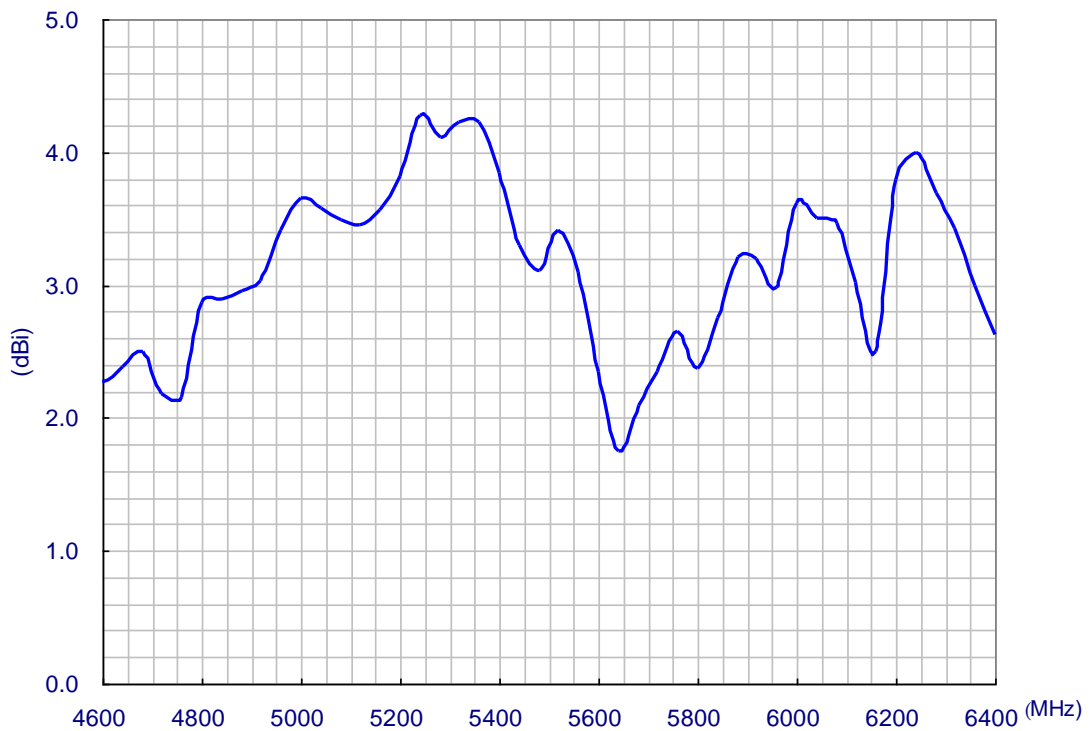
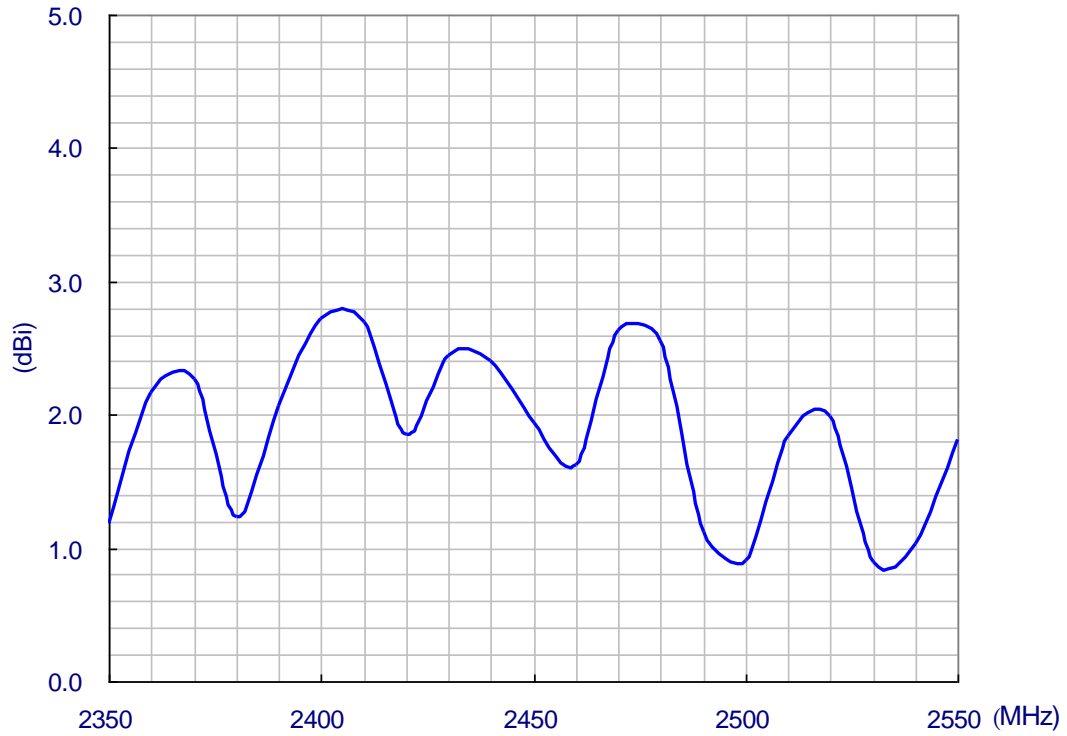

6.5 2.4/5.8GHz Antenna Peak Gain

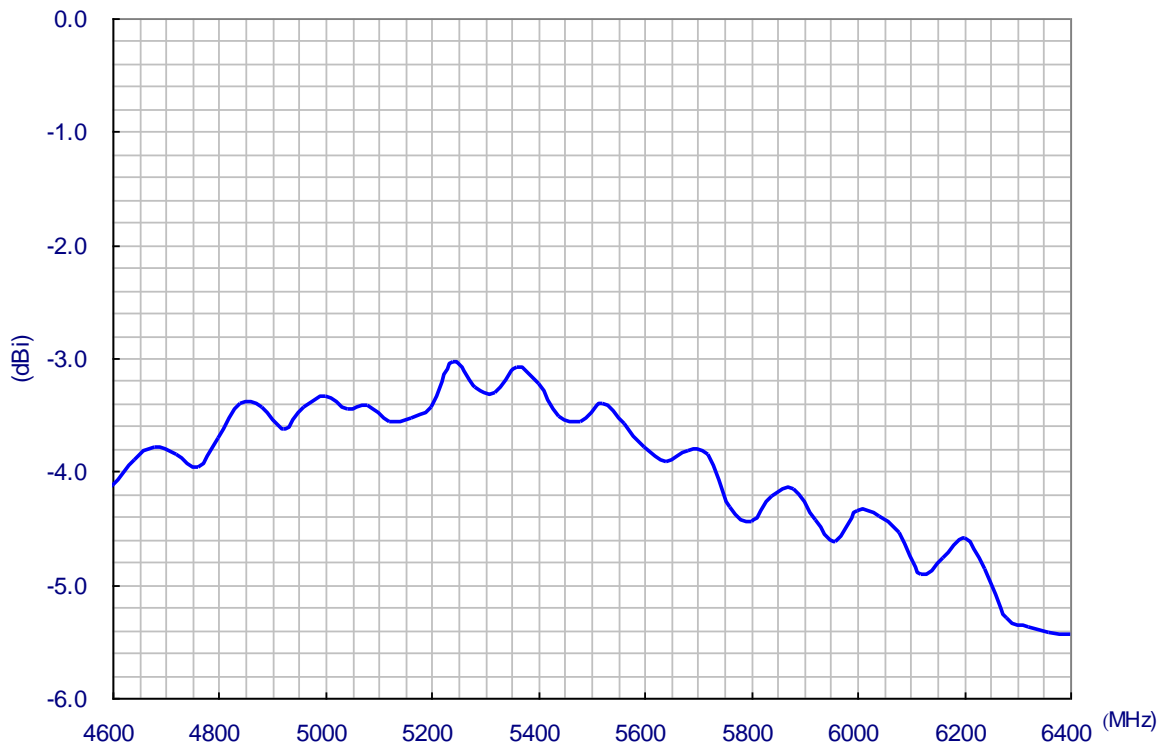
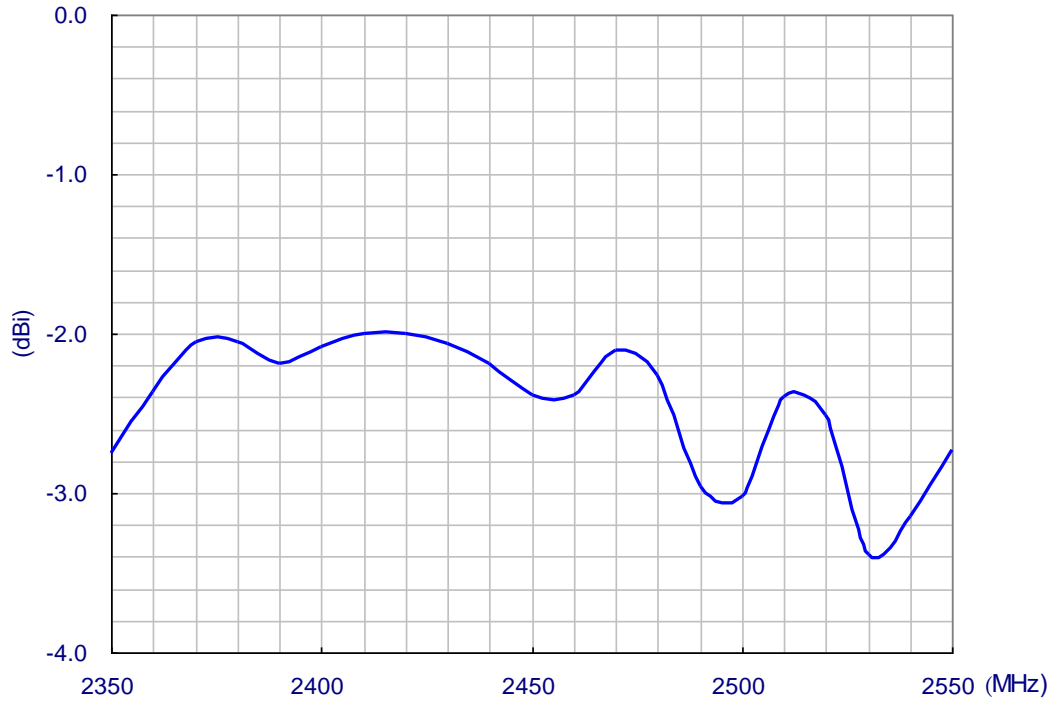

7. 2.4/5.8GHz Antenna Radiation Pattern

7.1 XY Plane

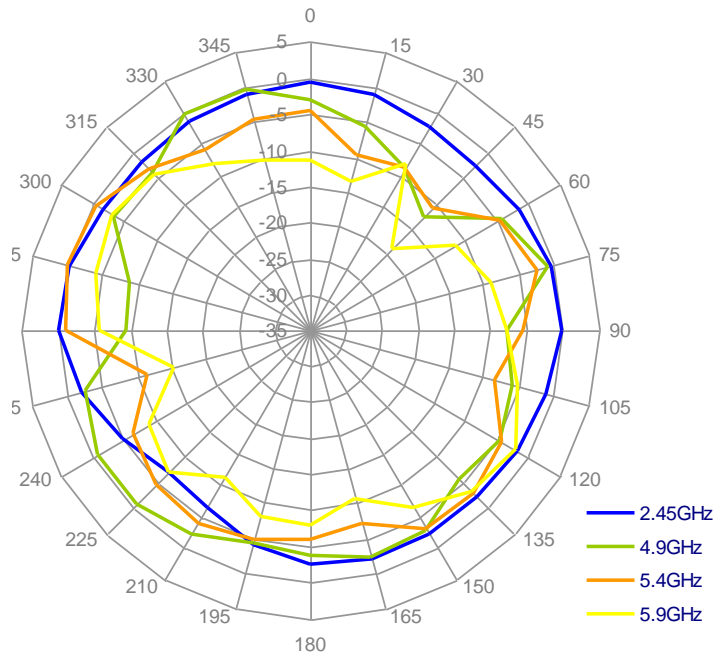

7.2 XZ Plane

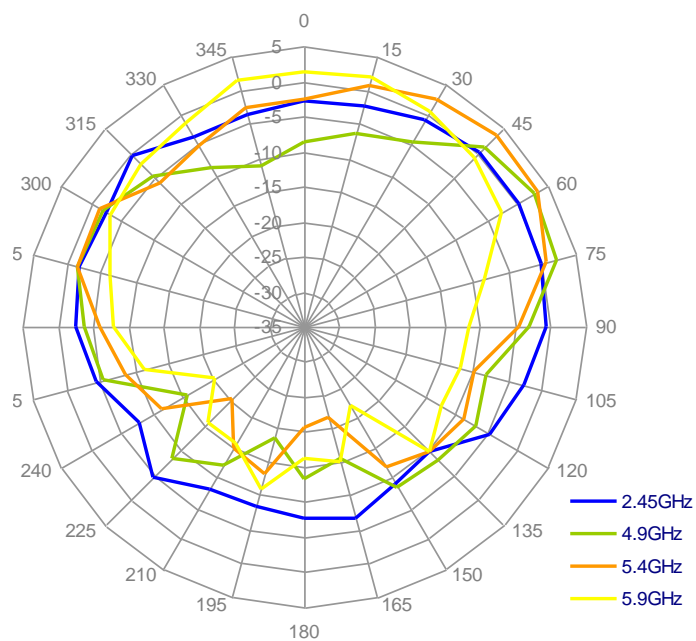

8. Mechanical Drawing

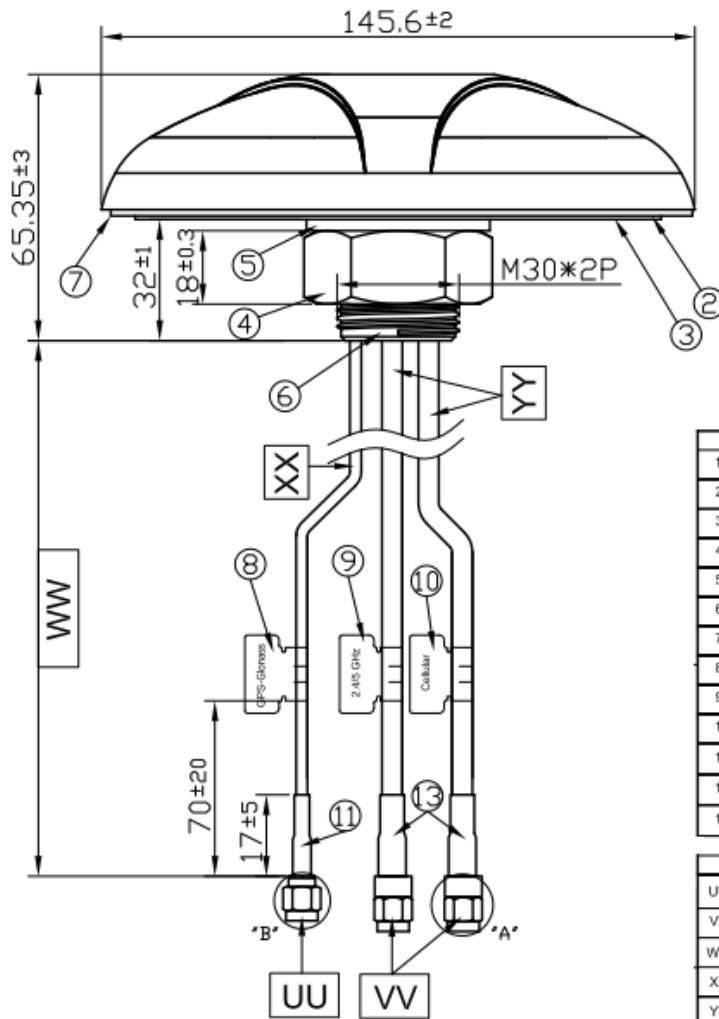

	Name	Material	Finish	QTY
1	Housing	PC 540	White	1
2	Closed Cell Foam	CR 4305	White Liner	1
3	3M Double Adhesive	3M 9448 HK	White Liner	1
4	M30 Nut	Steel AISI 1215	Ni Plated	1
5	Washer	Steel AISI 1215	Ni Plated	1
6	M30x 2 Thread 32L	Zinc Alloy	Ni Plated	1
7	Waterproof Rubber	Silicon	Black	1
8	GPS-Glonass Label	Coated Paper	Orange	1
9	2.4/5GHz Label	Coated Paper	Green	1
10	Cellular Label	Coated Paper	Blue	1
11	Heat Shrink Tube(RG174)	PE	Black	1
12	Rubber Stopper	Silicone Rubber	Black	1
13	Heat Shrink Tube(CFD200)	PE	Black	2

	Name	Spec	Finish	QTY
UU	Connector Type	SMA(M) ST	Gold	2
VV	Connector Type	SMA(M) ST	Gold	1
WW	Cable Length	3000±120mm		1
XX	Cable Type	RG174	Black	1
YY	Cable Type	CFD 200	Black	2

SMA(M) ST
DETAIL : 'A'
SCALE: 1/1

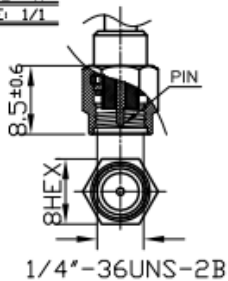

SMA(M) ST
DETAIL : 'B'
SCALE: 1/1

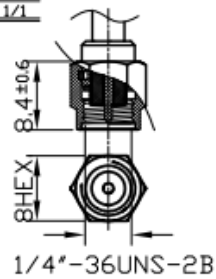

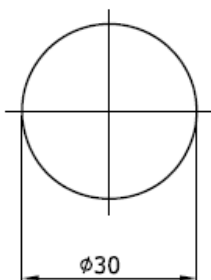
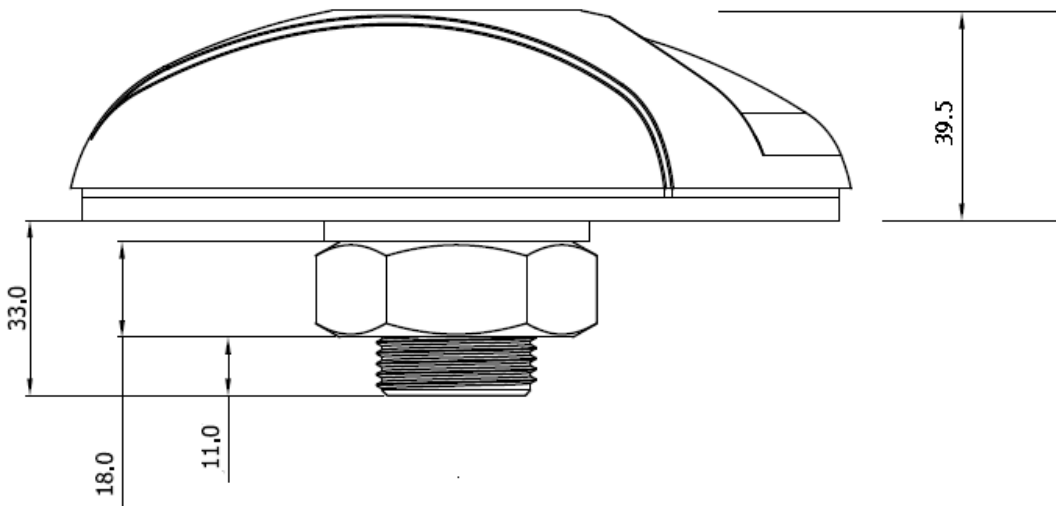
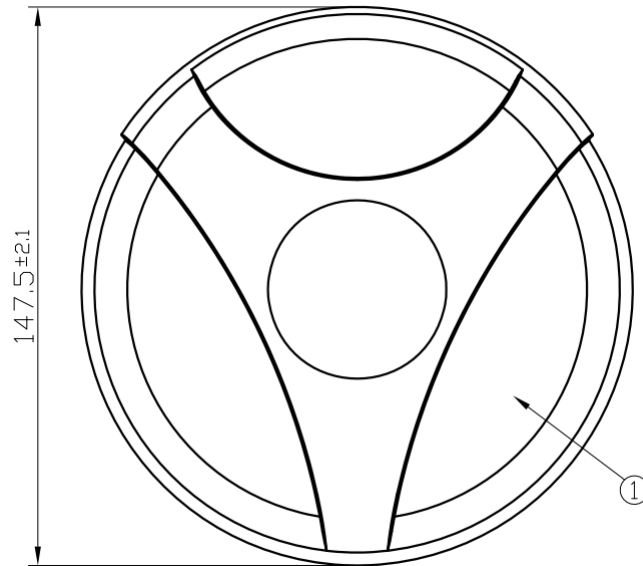

Thread
Diameter

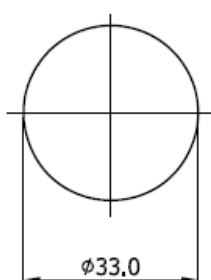

Recommended
Mounting Hole

Unit: mm

9. Installation

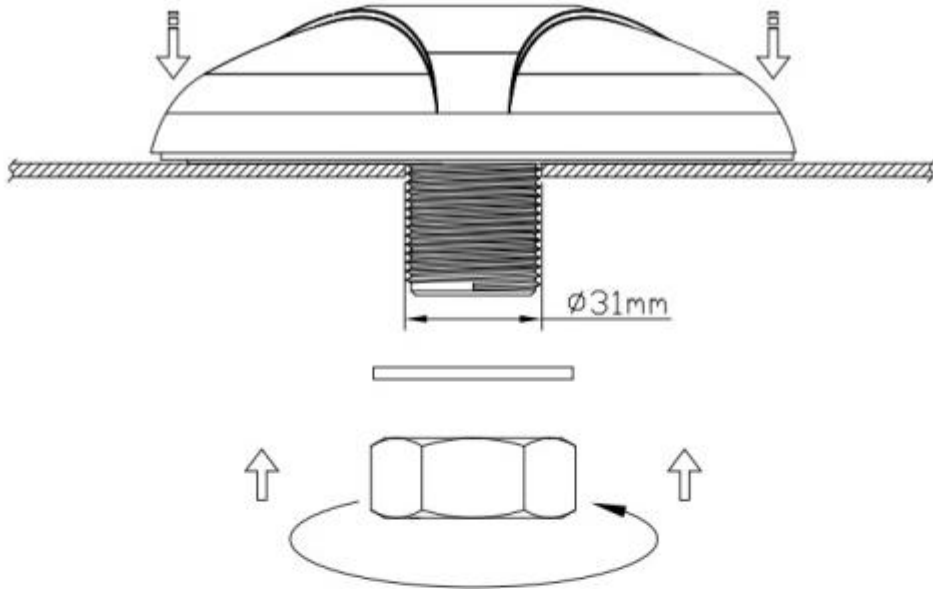

Recommended Torque for Mounting 49N·m
 Maximum Torque for Mounting 58.8N·m

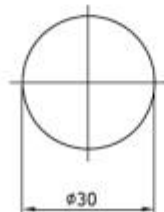
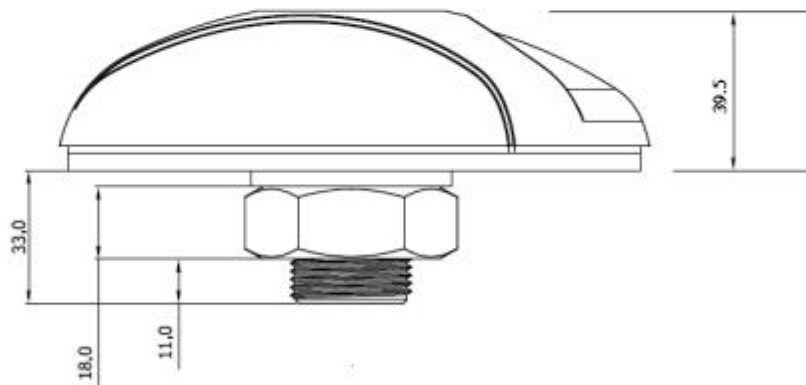

**Thread
 Diameter**

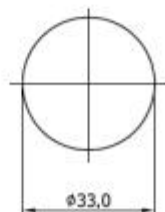

**Recommended
 Mounting Hole**

10. Packaging

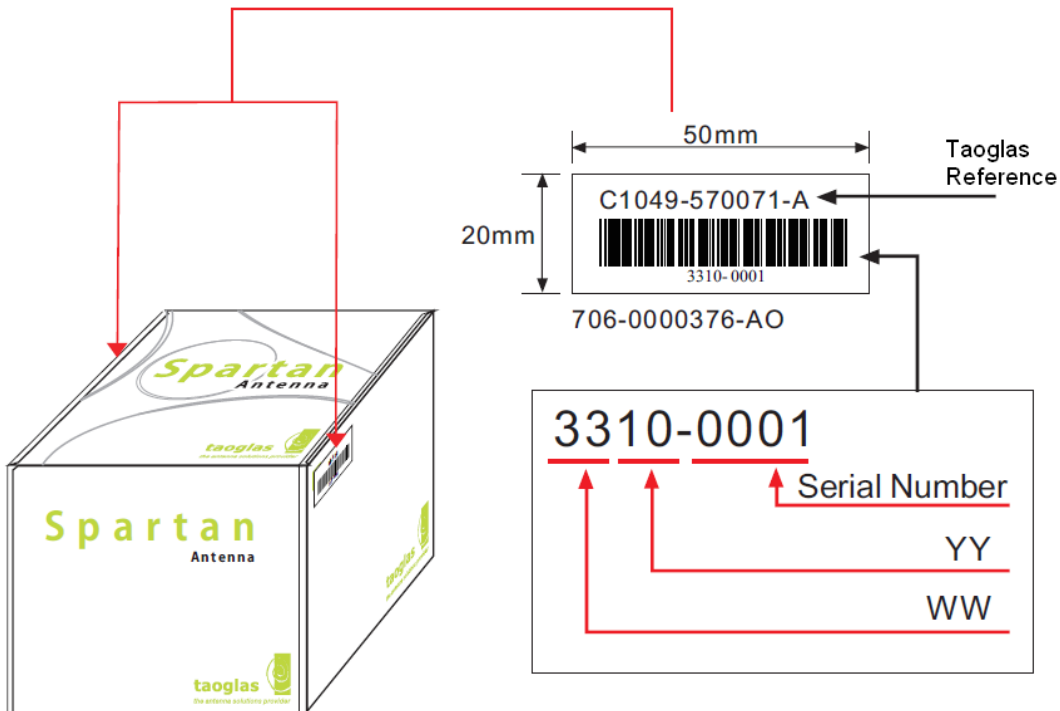
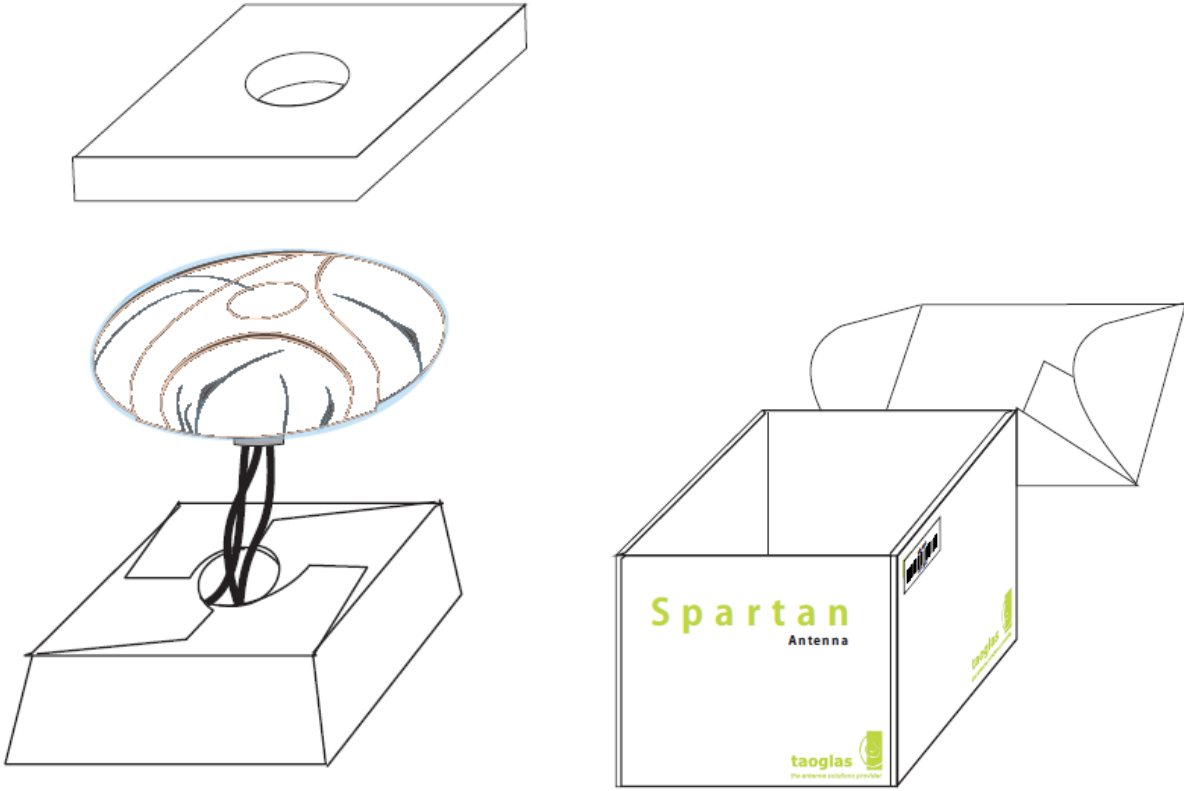

8 boxes per carton

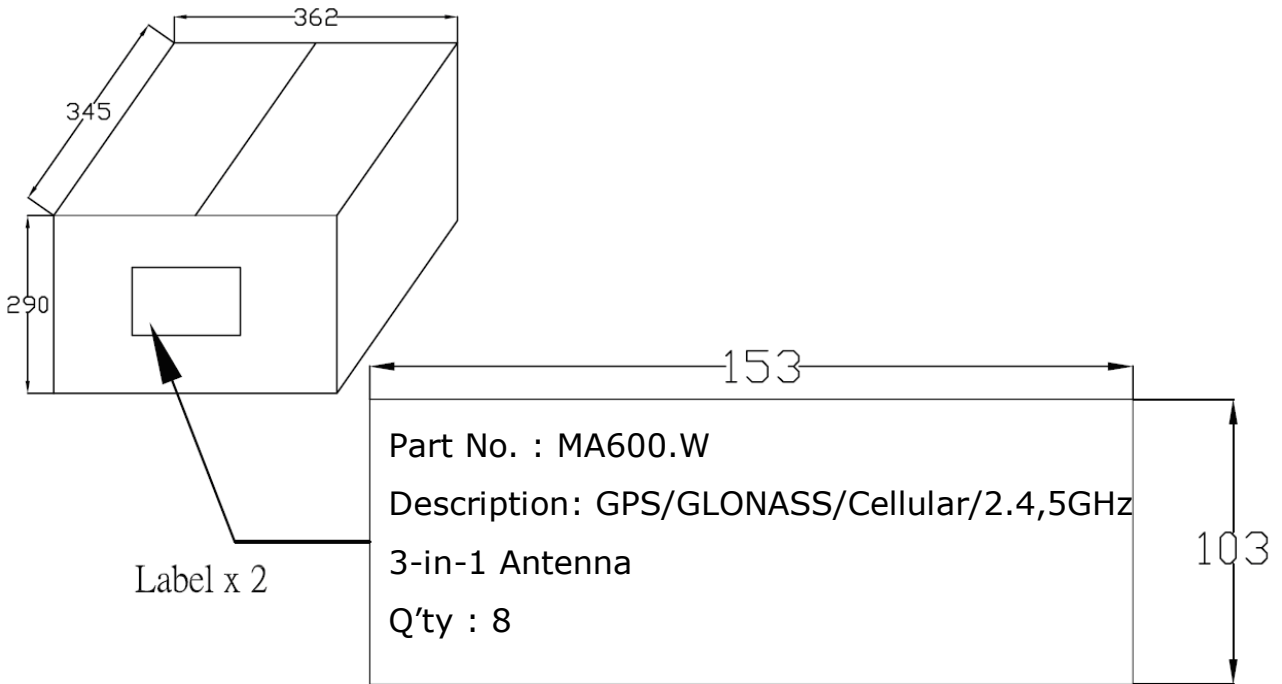

Taoglas makes no warranties based on the accuracy or completeness of the contents of this document and reserves the right to make changes to specifications and product descriptions at any time without notice. Taoglas reserves all rights to this document and the information contained herein.

Reproduction, use or disclosure to third parties without express permission is strictly prohibited.

Copyright © Taoglas Ltd.