

Abdeckung vorverrastet
cover loose mounted

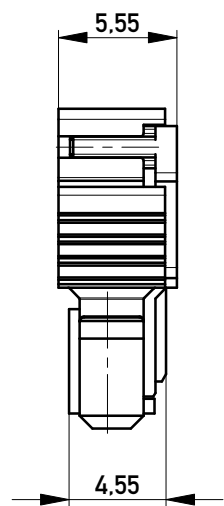

Abdeckung verpresst
cover pressed on

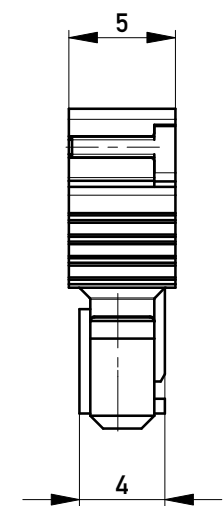

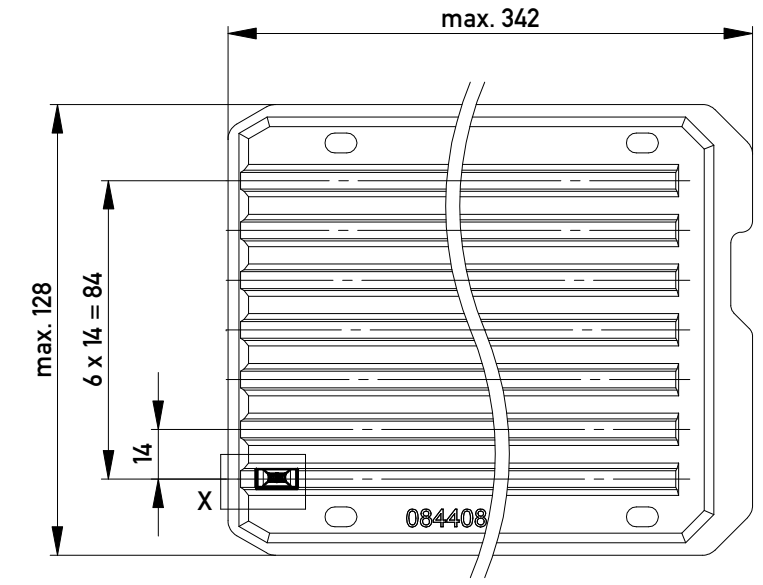

Verpackt in Tray - tray packaging
Verpackungseinheit 182 Stück - packaging unit 182

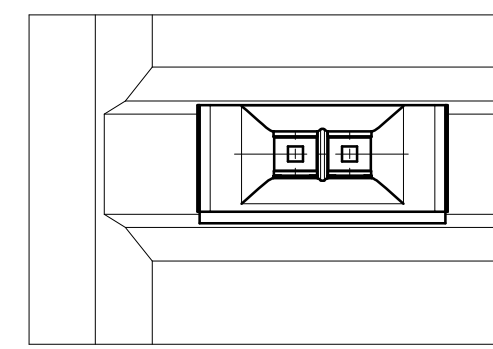

Einzelheit X
detail X

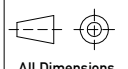

Copyright by ERNI GmbH
Proprietary notice pursuant to ISO 16016 to be observed.

Information: Codierung schwarz - coding black		Tolerances  All Dimensions in mm	Scale 3:1
All rights reserved. Only for Information. To ensure that this is the latest version of this drawing, please contact one of the ERNI companies before using.		Subject to modification without prior notice. Drawing will not be updated.	Designation F 2,54 SRC-A, 2-polig
b Index	25.02.2014 Date	 www.ERNI.com	100102070001 K A3
		Class SRCBUG	