



16 x 16 Nonblocking Video Crosspoint Switch with I/O Buffers

MAX4355

General Description

The MAX4355 is a 16 x 16 highly integrated video crosspoint switch matrix with input and output buffers. This device operates from dual ±3V to ±5V supplies or from a single +5V supply. Digital logic is supplied from an independent single +2.7V to +5.5V supply. All inputs and outputs are buffered, with all outputs able to drive standard 75Ω reverse-terminated video loads.

The switch matrix configuration and output buffer gain are programmed through an SPI™/QSPI™-compatible, 3-wire serial interface and initialized with a single update signal. The unique serial interface operates in two modes facilitating both fast updates and initialization. On power-up, all outputs are initialized in the disabled state to avoid output conflicts in large-array configurations.

Superior flexibility, high integration, and space-saving packaging make this nonblocking switch matrix ideal for routing video signals in security and video-on-demand systems.

The MAX4355 is available in a 100-pin TQFP package and specified over an extended -40°C to +85°C temperature range.

Applications

- Security Systems
- Video Routing
- Video-on-Demand Systems

Typical Operating Circuit

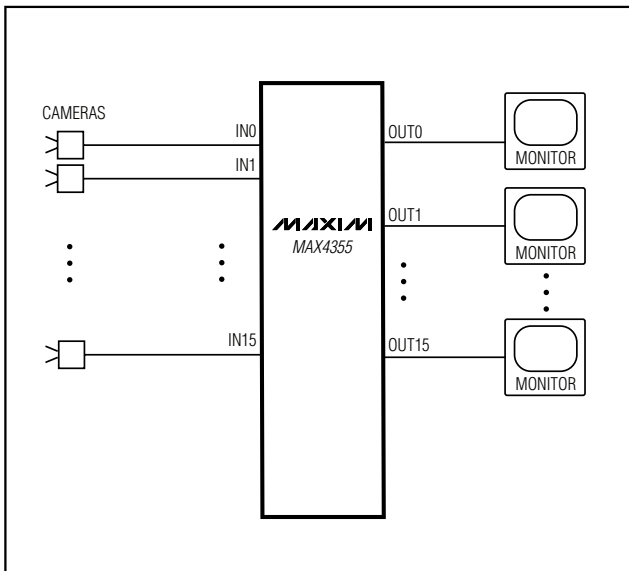

SPI and QSPI are trademarks of Motorola, Inc.

Features

- ◆ 16 x 16 Nonblocking Matrix with Buffered Inputs and Outputs
- ◆ Operates from ±3V, ±5V, or +5V Supplies
- ◆ Individually Programmable Output Buffer Gain ($A_V = +1V/V$ or $+2V/V$)
- ◆ High-Impedance Output Disable for Wired-OR Connections
- ◆ 0.1dB Gain Flatness to 14MHz
- ◆ -62dB Crosstalk, -110dB Isolation at 6MHz
- ◆ 0.02%/0.12° Differential Gain/Differential Phase Error
- ◆ Low 195mW Power Consumption (0.76mW per Point)

Ordering Information

PART	TEMP. RANGE	PIN-PACKAGE
MAX4355ECQ	-40°C to +85°C	100 TQFP

Pin Configuration appears at end of data sheet.

Functional Diagram

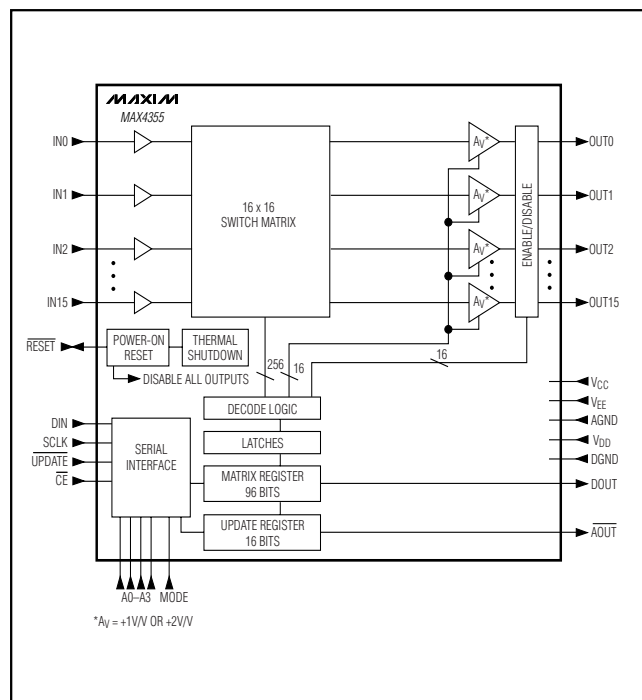

For pricing, delivery, and ordering information, please contact Maxim/Dallas Direct! at 1-888-629-4642, or visit Maxim's website at www.maxim-ic.com.

16 x 16 Nonblocking Video Crosspoint Switch with I/O Buffers

ABSOLUTE MAXIMUM RATINGS

Analog Supply Voltage ($V_{CC} - V_{EE}$)	+11V	Current into Any Analog Input Pin (IN_{-})	$\pm 50\text{mA}$
Digital Supply Voltage ($V_{DD} - DGND$)	+6V	Current into Any Analog Output Pin (OUT_{-})	$\pm 75\text{mA}$
Analog Supplies to Analog Ground ($V_{CC} - AGND$) and ($AGND - V_{EE}$)	+6V	Continuous Power Dissipation ($T_A = +70^{\circ}\text{C}$)	100-Pin TQFP (derate 22.2mW/ $^{\circ}\text{C}$ above $+70^{\circ}\text{C}$)
Analog Ground to Digital Ground	-0.3V to +0.3V	Operating Temperature Range	-40 $^{\circ}\text{C}$ to +85 $^{\circ}\text{C}$
IN_{-} Voltage Range	($V_{CC} + 0.3\text{V}$) to ($V_{EE} - 0.3\text{V}$)	Junction Temperature	+150 $^{\circ}\text{C}$
OUT_{-} Short-Circuit Duration to $AGND$, V_{CC} , or V_{EE}	Indefinite	Storage Temperature Range	-65 $^{\circ}\text{C}$ to +150 $^{\circ}\text{C}$
$SCLK$, CE , $UPDATE$, $MODE$, A_{-} , DIN , $DOUT$, $RESET$, $AOUT$	($V_{DD} + 0.3\text{V}$) to ($DGND - 0.3\text{V}$)	Lead Temperature (soldering, 10s)	+300 $^{\circ}\text{C}$

Stresses beyond those listed under "Absolute Maximum Ratings" may cause permanent damage to the device. These are stress ratings only, and functional operation of the device at these or any other conditions beyond those indicated in the operational sections of the specifications is not implied. Exposure to absolute maximum rating conditions for extended periods may affect device reliability.

DC ELECTRICAL CHARACTERISTICS—DUAL SUPPLIES $\pm 5\text{V}$

($V_{CC} = +5\text{V}$, $V_{EE} = -5\text{V}$, $V_{DD} = +5\text{V}$, $AGND = DGND = 0$, $V_{IN_{-}} = 0$, $R_L = 150\Omega$ to $AGND$, and $T_A = T_{MIN}$ to T_{MAX} , unless otherwise noted. Typical values are at $T_A = +25^{\circ}\text{C}$.)

PARAMETER	SYMBOL	CONDITIONS	MIN	TYP	MAX	UNITS
Operating Supply Voltage Range	$V_{CC} - V_{EE}$	Guaranteed by PSRR test	4.5		10.5	V
Logic-Supply Voltage Range	V_{DD} to $DGND$		2.7		5.5	V
Gain (Note 1)	A_V	$(V_{EE} + 2.5\text{V}) < V_{IN_{-}} < (V_{CC} - 2.5\text{V})$, $A_V = +1\text{V/V}$, $R_L = 150\Omega$	0.97	0.995	1	V/V
		$(V_{EE} + 2.5\text{V}) < V_{IN_{-}} < (V_{CC} - 2.5\text{V})$, $A_V = +1\text{V/V}$, $R_L = 10\text{k}\Omega$	0.99	0.999	1	
		$(V_{EE} + 3.75\text{V}) < V_{IN_{-}} < (V_{CC} - 3.75\text{V})$, $A_V = +2\text{V/V}$, $R_L = 150\Omega$	1.92	1.996	2.08	
		$(V_{EE} + 3.75\text{V}) < V_{IN_{-}} < (V_{CC} - 3.75\text{V})$, $A_V = +2\text{V/V}$, $R_L = 10\text{k}\Omega$	1.94	2.008	2.06	
		$(V_{EE} + 1\text{V}) < V_{IN_{-}} < (V_{CC} - 1.2\text{V})$, $A_V = +1\text{V/V}$, $R_L = 10\text{k}\Omega$	0.95	0.994	1	
Gain Matching (Channel to Channel)		$R_L = 10\text{k}\Omega$		0.5	1.5	%
		$R_L = 150\Omega$		0.5	2	

16 x 16 Nonblocking Video Crosspoint Switch with I/O Buffers

MAX4355

DC ELECTRICAL CHARACTERISTICS—DUAL SUPPLIES $\pm 5V$ (continued)

($V_{CC} = +5V$, $V_{EE} = -5V$, $V_{DD} = +5V$, $AGND = DGND = 0$, $V_{IN_} = 0$, $R_L = 150\Omega$ to $AGND$, and $T_A = T_{MIN}$ to T_{MAX} , unless otherwise noted. Typical values are at $T_A = +25^\circ C$.)

PARAMETER	SYMBOL	CONDITIONS		MIN	TYP	MAX	UNITS
Temperature Coefficient of Gain	TC_{AV}			10			ppm/ $^\circ C$
Input Voltage Range	$V_{IN_}$	$A_V = +1V/V$	$R_L = 10k\Omega$	$V_{EE} + 1$		$V_{CC} - 1.2$	V
			$R_L = 150\Omega$	$V_{EE} + 2.5$		$V_{CC} - 2.5$	
		$A_V = +2V/V$	$R_L = 10k\Omega$	$V_{EE} + 3$		$V_{CC} - 3.1$	
			$R_L = 150\Omega$	$V_{EE} + 3.75$		$V_{CC} - 3.75$	
Output Voltage Range	V_{OUT}	$R_L = 10k\Omega$		$V_{EE} + 1$		$V_{CC} - 1.2$	V
		$R_L = 150\Omega$		$V_{EE} + 2.5$		$V_{CC} - 2.5$	V
Input Bias Current	I_B				4	11	μA
Input Resistance	$R_{IN_}$	$(V_{EE} + 1V) < V_{IN_} < (V_{CC} - 1.2V)$			10		$M\Omega$
Output Offset Voltage	V_{OFFSET}	$A_V = +1V/V$			± 5	± 20	mV
		$A_V = +2V/V$			± 10	± 40	
Output Short-Circuit Current	I_{SC}	Sinking or sourcing, $R_L = 1\Omega$			± 40		mA
Enabled Output Impedance	Z_{OUT}	$(V_{EE} + 1V) < V_{IN_} < (V_{CC} - 1.2V)$			0.2		Ω
Output Leakage Current, Disable Mode	I_{OD}	$(V_{EE} + 1V) < V_{OUT_} < (V_{CC} - 1.2V)$			0.004	1	μA
DC Power-Supply Rejection Ratio	PSRR	$4.5V < (V_{CC} - V_{EE}) < 10.5V$		60	70		dB
Quiescent Supply Current	I_{CC}	$R_L = \infty$	Outputs enabled, $T_A = +25^\circ C$		100	150	mA
			Outputs enabled			175	
			Outputs disabled		55	75	
	I_{EE}	$R_L = \infty$	Outputs enabled, $T_A = +25^\circ C$		95	150	
			Outputs enabled			175	
			Outputs disabled		50	75	
I_{DD}				4	8		

16 x 16 Nonblocking Video Crosspoint Switch with I/O Buffers

DC ELECTRICAL CHARACTERISTICS—DUAL SUPPLIES $\pm 3V$

($V_{CC} = +3V$, $V_{EE} = -3V$, $V_{DD} = +3V$, $AGND = DGND = 0$, $V_{IN_} = 0$, $R_L = 150\Omega$ to $AGND$, and $T_A = T_{MIN}$ to T_{MAX} , unless otherwise noted. Typical values are at $T_A = +25^\circ C$.)

PARAMETER	SYMBOL	CONDITIONS	MIN	TYP	MAX	UNITS
Operating Supply Voltage Range	$V_{CC} - V_{EE}$	Guaranteed by PSRR test	4.5		10.5	V
Logic-Supply Voltage Range	V_{DD} to $DGND$		2.7		5.5	V
Gain (Note 1)	A_V	$(V_{EE} + 1V) < V_{IN_} < (V_{CC} - 1.2V)$, $A_V = +1V/V$, $R_L = 150\Omega$	0.94	0.983	1	V/V
		$(V_{EE} + 1V) < V_{IN_} < (V_{CC} - 1.2V)$, $A_V = +1V/V$, $R_L = 10k\Omega$	0.96	0.993	1	
		$(V_{EE} + 2V) < V_{IN_} < (V_{CC} - 2.1V)$, $A_V = +2V/V$, $R_L = 150\Omega$	1.92	1.985	2.08	
		$(V_{EE} + 2V) < V_{IN_} < (V_{CC} - 2.1V)$, $A_V = +2V/V$, $R_L = 10k\Omega$	1.94	2.000	2.06	
Gain Matching (Channel to Channel)		$R_L = 10k\Omega$		0.5	1.5	%
		$R_L = 150\Omega$		0.5	2	
Temperature Coefficient of Gain	TC_{AV}			10		ppm/ $^\circ C$
Input Voltage Range	$V_{IN_}$	$A_V = +1V/V$	$R_L = 10k\Omega$	$V_{EE} + 1$	$V_{CC} - 1.2$	V
			$R_L = 150\Omega$	$V_{EE} + 1$	$V_{CC} - 1.2$	
		$A_V = +2V/V$	$R_L = 10k\Omega$	$V_{EE} + 2$	$V_{CC} - 2.1$	
			$R_L = 150\Omega$	$V_{EE} + 2$	$V_{CC} - 2.1$	
Output Voltage Range	V_{OUT}	$R_L = 10k\Omega$	$V_{EE} + 1$	$V_{CC} - 1.2$	V	
		$R_L = 150\Omega$	$V_{EE} + 1$	$V_{CC} - 1.2$		
Input Bias Current	I_B			4	11	μA
Input Resistance	R_{IN}	$(V_{EE} + 1V) < V_{IN_} < (V_{CC} - 1.2V)$		10		$M\Omega$
Output Offset Voltage	V_{OFFSET}	$A_V = +1V/V$		± 5	± 20	mV
		$A_V = +2V/V$		± 10	± 40	

16 x 16 Nonblocking Video Crosspoint Switch with I/O Buffers

MAX4355

DC ELECTRICAL CHARACTERISTICS—DUAL SUPPLIES ±3V (continued)

($V_{CC} = +3V$, $V_{EE} = -3V$, $V_{DD} = +3V$, $AGND = DGND = 0$, $V_{IN_} = 0$, $R_L = 150\Omega$ to $AGND$, and $T_A = T_{MIN}$ to T_{MAX} , unless otherwise noted. Typical values are at $T_A = +25^\circ C$.)

PARAMETER	SYMBOL	CONDITIONS		MIN	TYP	MAX	UNITS
Output Short-Circuit Current	I_{SC}	Sinking or sourcing, $R_L = 1\Omega$		±40			mA
Enabled Output Impedance	Z_{OUT}	$(V_{EE} + 1V) < V_{IN_} < (V_{CC} - 1.2V)$		0.2			Ω
Output Leakage Current, Disable Mode	I_{OD}	$(V_{EE} + 1V) < V_{OUT_} < (V_{CC} - 1.2V)$		0.004	1		μA
DC Power-Supply Rejection Ratio	PSRR	$4.5V < (V_{CC} - V_{EE}) < 10.5V$		60	75		dB
Quiescent Supply Current	I_{CC}	$R_L = \infty$	Outputs enabled	80		mA	
			Outputs disabled	40			
	I_{EE}	$R_L = \infty$	Outputs enabled	75			
			Outputs disabled	35			
I_{DD}			4				

DC ELECTRICAL CHARACTERISTICS—SINGLE SUPPLY +5V

($V_{CC} = +5V$, $V_{EE} = 0$, $V_{DD} = +5V$, $AGND = DGND = 0$, $V_{IN_} = +1.75V$, $A_V = +1V/V$, $R_L = 150\Omega$ to $AGND$, and $T_A = T_{MIN}$ to T_{MAX} , unless otherwise noted. Typical values are at $T_A = +25^\circ C$.)

PARAMETER	SYMBOL	CONDITIONS		MIN	TYP	MAX	UNITS
Operating Supply Voltage Range	V_{CC}	Guaranteed by PSRR test		4.5	5.5		V
Logic-Supply Voltage Range	V_{DD} to $DGND$			2.7	5.5		V
Gain (Note 1)	A_V	$(V_{EE} + 1V) < V_{IN} < (V_{CC} - 2.5V)$, $A_V = +1V/V$, $R_L = 150\Omega$		0.94	0.995	1	V/V
		$(V_{EE} + 1V) < V_{IN} < (V_{CC} - 1.2V)$, $A_V = +1V/V$, $R_L = 10k\Omega$		0.94	0.995	1	
Gain Matching (Channel to Channel)		$R_L = 10k\Omega$		0.5		3	%
		$R_L = 150\Omega$		0.5		3	
Temperature Coefficient of Gain	TC_{AV}			10		ppm/ $^\circ C$	
Input Voltage Range	V_{IN}	$A_V = +1V/V$	$R_L = 10k\Omega$	$V_{EE} + 1$	$V_{CC} - 1.2$		V
			$R_L = 150\Omega$	$V_{EE} + 1$	$V_{CC} - 2.5$		

16 x 16 Nonblocking Video Crosspoint Switch with I/O Buffers

DC ELECTRICAL CHARACTERISTICS—SINGLE SUPPLY +5V (continued)

($V_{CC} = +5V$, $V_{EE} = 0$, $V_{DD} = +5V$, $AGND = DGND = 0$, $V_{IN_} = +1.75V$, $A_V = +1V/V$, $R_L = 150\Omega$ to $AGND$, and $T_A = T_{MIN}$ to T_{MAX} , unless otherwise noted. Typical values are at $T_A = +25^\circ C$.)

PARAMETER	SYMBOL	CONDITIONS	MIN	TYP	MAX	UNITS
Output Voltage Range	V_{OUT}	$A_V = +1V/V$, $R_L = 10k\Omega$	$V_{EE} + 1$		$V_{CC} - 1.2$	V
		$A_V = +1V/V$, $R_L = 150\Omega$	$V_{EE} + 1$		$V_{CC} - 2.5$	
Input Bias Current	I_B			4	11	μA
Input Resistance	R_{IN}	$V_{EE} + 1V < V_{IN_} < V_{CC} - 1.2V$		10		$M\Omega$
Output Offset Voltage	V_{OFFSET}	$A_V = +1V/V$		± 10	± 40	mV
Output Short-Circuit Current	I_{SC}	Sinking or sourcing, $R_L = 1\Omega$		± 35		mA
Enabled Output Impedance	Z_{OUT}	$(V_{EE} + 1V) < V_{IN_} < (V_{CC} - 1.2V)$		0.2		Ω
Output Leakage Current, Disable Mode	I_{OD}	$(V_{EE} + 1V) < V_{OUT_} < (V_{CC} - 1.2V)$		0.004	1	μA
DC Power-Supply Rejection Ratio	PSRR	$4.5V < (V_{CC} - V_{EE}) < 5.5V$	$T_A = +25^\circ C$ to $+85^\circ C$	50	65	dB
			$T_A = -40^\circ C$ to $+85^\circ C$	35		
Quiescent Supply Current	I_{CC}	$R_L = \infty$	Outputs enabled, $T_A = +25^\circ C$		80	mA
			Outputs disabled		35	
	I_{EE}	$R_L = \infty$	Outputs enabled, $T_A = +25^\circ C$		75	
			Outputs disabled		30	
I_{DD}				4		

16 x 16 Nonblocking Video Crosspoint Switch with I/O Buffers

MAX4355

LOGIC-LEVEL CHARACTERISTICS

($V_{CC} - V_{EE}$) = +4.5V to +10.5V, V_{DD} = +2.7V to +5.5V, AGND = DGND = 0, $V_{IN_}$ = 0, R_L = 150 Ω to AGND, and T_A = T_{MIN} to T_{MAX} , unless otherwise noted. Typical values are at T_A = +25°C.) (Note 2)

PARAMETER	SYMBOL	CONDITIONS		MIN	TYP	MAX	UNITS
Input Voltage High Level	V_{IH}	$V_{DD} = +5.0V$		3			V
		$V_{DD} = +3V$		2			
Input Voltage Low Level	V_{IL}	$V_{DD} = +5.0V$		0.8			V
		$V_{DD} = +3V$		0.6			
Input Current High Level	I_{IH}	$V_I > 2V$	Excluding \overline{RESET}	-1	0.01	1	μA
			\overline{RESET}	-30	-20		
Input Current Low Level	I_{IL}	$V_I < 1V$	Excluding \overline{RESET}	-1	0.01	1	μA
			\overline{RESET}	-300	-235		
Output Voltage High Level	V_{OH}	$I_{SOURCE} = 1mA, V_{DD} = +5V$		4.7	4.9		V
		$I_{SOURCE} = 1mA, V_{DD} = +3V$		2.7	2.9		
Output Voltage Low Level	V_{OL}	$I_{SINK} = 1mA, V_{DD} = +5V$			0.1	0.3	V
		$I_{SINK} = 1mA, V_{DD} = +3V$			0.1	0.3	
Output Current High Level	I_{OH}	$V_{DD} = +5V, V_O = +4.9V$		1	4		mA
		$V_{DD} = +3V, V_O = +2.7V$		1	8		
Output Current Low Level	I_{OL}	$V_{DD} = +5V, V_O = +0.1V$		1	4		mA
		$V_{DD} = +3V, V_O = +0.3V$		1	8		

AC ELECTRICAL CHARACTERISTICS—DUAL SUPPLIES $\pm 5V$

($V_{CC} = +5V, V_{EE} = -5V, V_{DD} = +5V, AGND = DGND = 0, V_{IN_} = 0, R_L = 150\Omega$ to AGND, and $T_A = +25^\circ C$, unless otherwise noted.)

PARAMETER	SYMBOL	CONDITIONS		MIN	TYP	MAX	UNITS
Small-Signal -3dB Bandwidth	BW_{SS}	$V_{OUT} = 20mVp-p$	$A_V = +1V/V$		110		MHz
			$A_V = +2V/V$		78		
Medium-Signal -3dB Bandwidth	BW_{MS}	$V_{OUT_} = 200mVp-p$	$A_V = +1V/V$		80		MHz
			$A_V = +2V/V$		75		
Large-Signal -3dB Bandwidth	BW_{LS}	$V_{OUT_} = 2Vp-p$	$A_V = +1V/V$		40		MHz
			$A_V = +2V/V$		50		
Small-Signal 0.1dB Bandwidth	$BW_{0.1dB-SS}$	$V_{OUT} = 20mVp-p$	$A_V = +1V/V$		14		MHz
			$A_V = +2V/V$		11		
Medium-Signal 0.1dB Bandwidth	$BW_{0.1dB-MS}$	$V_{OUT_} = 200mVp-p$	$A_V = +1V/V$		14		MHz
			$A_V = +2V/V$		11		
Large-Signal 0.1dB Bandwidth	$BW_{0.1dB-LS}$	$V_{OUT_} = 2Vp-p$	$A_V = +1V/V$		14		MHz
			$A_V = +2V/V$		11		
Slew Rate	SR	$V_{OUT_} = 2V$ step, $A_V = +1V/V$			150		V/ μs
		$V_{OUT_} = 2V$ step, $A_V = +2V/V$			150		

16 x 16 Nonblocking Video Crosspoint Switch with I/O Buffers

AC ELECTRICAL CHARACTERISTICS—DUAL SUPPLIES $\pm 5V$ (continued)

($V_{CC} = +5V$, $V_{EE} = -5V$, $V_{DD} = +5V$, $AGND = DGND = 0$, $V_{INL} = 0$, $R_L = 150\Omega$ to $AGND$, $A_V = +1V/V$, and $T_A = +25^\circ C$, unless otherwise noted.)

PARAMETER	SYMBOL	CONDITIONS		MIN	TYP	MAX	UNITS
Settling Time	$t_{s\ 0.1\%}$	$V_{OUT_} = 0$ to 2V step	$A_V = +1V/V$		60		ns
			$A_V = +2V/V$		60		
Switching Transient (Glitch) (Note 3)			$A_V = +1V/V$		50		mV
			$A_V = +2V/V$		45		
AC Power-Supply Rejection Ratio			$f = 100kHz$		70		dB
			$f = 1MHz$		68		
Differential Gain Error (Note 4)			$R_L = 1k\Omega$		0.002		%
			$R_L = 150\Omega$		0.02		
Differential Phase Error (Note 4)			$R_L = 1k\Omega$		0.02		degrees
			$R_L = 150\Omega$		0.12		
Crosstalk, All Hostile			$f = 6MHz$		-62		dB
Off-Isolation, Input to Output			$f = 6MHz$		-110		dB
Input Noise Voltage Density	e_n		$BW = 6MHz$		73		μV_{RMS}
Input Capacitance	C_{IN}				5		pF
Disabled Output Capacitance			Amplifier in disable mode		3		pF
Capacitive Load at 3dB Output Peaking					30		pF
Output Impedance	Z_{OUT}	$f = 6MHz$	Output enabled		3		Ω
			Output disabled		4k		

AC ELECTRICAL CHARACTERISTICS—DUAL SUPPLIES $\pm 3V$

($V_{CC} = +3V$, $V_{EE} = -3V$, $V_{DD} = +3V$, $AGND = DGND = 0$, $V_{INL} = 0$, $R_L = 150\Omega$ to $AGND$, $A_V = +1V/V$, and $T_A = +25^\circ C$, unless otherwise noted.)

PARAMETER	SYMBOL	CONDITIONS		MIN	TYP	MAX	UNITS
Small-Signal -3dB Bandwidth	BW_{SS}	$V_{OUT_} = 20mVp-p$	$A_V = +1V/V$		110		MHz
			$A_V = +2V/V$		70		
Medium-Signal -3dB Bandwidth	BW_{MS}	$V_{OUT_} = 200mVp-p$	$A_V = +1V/V$		110		MHz
			$A_V = +2V/V$		70		
Large-Signal -3dB Bandwidth	BW_{LS}	$V_{OUT_} = 2Vp-p$	$A_V = +1V/V$		32		MHz
			$A_V = +2V/V$		38		
Small-Signal 0.1dB Bandwidth	$BW_{0.1dB-SS}$	$V_{OUT_} = 20mVp-p$	$A_V = +1V/V$		12		MHz
			$A_V = +2V/V$		12		
Medium-Signal 0.1dB Bandwidth	$BW_{0.1dB-MS}$	$V_{OUT_} = 200mVp-p$	$A_V = +1V/V$		12		MHz
			$A_V = +2V/V$		12		
Large-Signal 0.1dB Bandwidth	$BW_{0.1dB-LS}$	$V_{OUT_} = 2Vp-p$	$A_V = +1V/V$		12		MHz
			$A_V = +2V/V$		12		

16 x 16 Nonblocking Video Crosspoint Switch with I/O Buffers

MAX4355

AC ELECTRICAL CHARACTERISTICS—DUAL SUPPLIES $\pm 3V$ (continued)

($V_{CC} = +3V$, $V_{EE} = -3V$, $V_{DD} = +3V$, $AGND = DGND = 0$, $V_{IN_} = 0$, $R_L = 150\Omega$ to $AGND$, $A_V = +1V/V$, and $T_A = +25^\circ C$, unless otherwise noted.)

PARAMETER	SYMBOL	CONDITIONS	MIN	TYP	MAX	UNITS
Slew Rate	SR	$V_{OUT_} = 2V$ step, $A_V = +1V/V$		125		V/ μs
		$V_{OUT_} = 2V$ step, $A_V = +2V/V$		125		
Settling Time	$t_{S\ 0.1\%}$	$V_O = 0$ to $2V$ step	$A_V = +1V/V$	60		ns
			$A_V = +2V/V$	60		
Switching Transient (Glitch) (Note 3)		$A_V = +1V/V$		20		mV
		$A_V = +2V/V$		20		
AC Power-Supply Rejection Ratio		$f = 100kHz$		72		dB
		$f = 1MHz$		71		
Differential Gain Error (Note 4)		$R_L = 1k\Omega$		0.02		%
		$R_L = 150\Omega$		0.15		
Differential Phase Error (Note 4)		$R_L = 1k\Omega$		0.05		degrees
		$R_L = 150\Omega$		0.2		
Crosstalk, All Hostile		$f = 6MHz$		-63		dB
Off-Isolation, Input to Output		$f = 6MHz$		-112		dB
Input Noise Voltage Density	e_n	$BW = 6MHz$		73		μV_{RMS}
Input Capacitance	$C_{IN_}$			5		pF
Disabled Output Capacitance		Amplifier in disable mode		3		pF
Capacitive Load at 3dB Output Peaking				30		pF
Output Impedance	Z_{OUT}	$f = 6MHz$	Output enabled	3		Ω
			Output disabled	4k		

16 x 16 Nonblocking Video Crosspoint Switch with I/O Buffers

AC ELECTRICAL CHARACTERISTICS—SINGLE SUPPLY +5V

($V_{CC} = +5V$, $V_{EE} = 0$, $V_{DD} = +5V$, $AGND = DGND = 0$, $V_{IN_} = 1.75V$, $R_L = 150\Omega$ to $AGND$, $A_V = +1V/V$, and $T_A = +25^\circ C$, unless otherwise noted.)

PARAMETER	SYMBOL	CONDITIONS	MIN	TYP	MAX	UNITS
Small-Signal -3dB Bandwidth	BW _{SS}	$V_{OUT_} = 20mVp-p$		100		MHz
Medium-Signal -3dB Bandwidth	BW _{MS}	$V_{OUT_} = 200mVp-p$		100		MHz
Large-Signal -3dB Bandwidth	BW _{LS}	$V_{OUT_} = 1.5Vp-p$		40		MHz
Small-Signal 0.1dB Bandwidth	BW _{0.1dB-SS}	$V_{OUT_} = 20mVp-p$		10		MHz
Medium-Signal 0.1dB Bandwidth	BW _{0.1dB-MS}	$V_{OUT_} = 200mVp-p$		12		MHz
Large-Signal 0.1dB Bandwidth	BW _{0.1dB-LS}	$V_{OUT_} = 1.5Vp-p$		14		MHz
Slew Rate	SR	$V_{OUT_} = 2V$ step, $A_V = +1V/V$		100		V/ μs
Settling Time	$t_{s\ 0.1\%}$	$V_{OUT_} = 0$ to $2V$ step		60		ns
Switching Transient (Glitch)				25		mV
AC Power-Supply Rejection Ratio		$f = 100kHz$		70		dB
		$f = 1MHz$		69		
Differential Gain Error (Note 4)		$R_L = 1k\Omega$		0.1		%
		$R_L = 150\Omega$		0.2		
Differential Phase Error (Note 4)		$R_L = 1k\Omega$		0.05		degrees
		$R_L = 150\Omega$		0.2		
Crosstalk, All Hostile		$f = 6MHz$		-63		dB
Off-Isolation, Input to Output		$f = 6MHz$		-110		dB
Input Noise Voltage Density	e_n	$BW = 6MHz$		73		μV_{RMS}
Input Capacitance	$C_{IN_}$			5		pF
Disabled Output Capacitance		Amplifier in disable mode		3		pF
Capacitive Load at 3dB Output Peaking				30		pF
Output Impedance	Z_{OUT}	$f = 6MHz$	Output enabled	3		Ω
			Output disabled	4k		

16 x 16 Nonblocking Video Crosspoint Switch with I/O Buffers

MAX4355

SWITCHING CHARACTERISTICS

($V_{CC} - V_{EE}$) = +4.5V to +10.5V, V_{DD} = +2.7V to +5.5V, $DGND = AGND = 0$, $V_{IN_}$ = 0 for dual supplies, $V_{IN_}$ = +1.75V for single supply, $R_L = 150\Omega$ to AGND, $C_L = 100pF$, $A_V = +1V/V$, and $T_A = T_{MIN}$ to T_{MAX} , unless otherwise noted. Typical values are at $T_A = +25^\circ C$.)

PARAMETER	SYMBOL	CONDITIONS	MIN	TYP	MAX	UNITS
Delay: \overline{UPDATE} to Video Out	t_{PdUdVo}	$V_{IN} = 0.5V$ step		200	450	ns
Delay: \overline{UPDATE} to \overline{AOUT}	t_{PdUdAo}	MODE = 0, time to $\overline{AOUT} = \text{low}$ after $\overline{UPDATE} = \text{low}$		30	200	ns
Delay: SCLK to DOUT Valid	t_{PdDo}	Logic state change in DOUT on active SCLK edge		30	200	ns
Delay: Output Disable	t_{PdHOe}	$V_{OUT} = 0.5V$, $1k\Omega$ pulldown to AGND		300	800	ns
Delay: Output Enable	t_{PdLOe}	Output disabled, $1k\Omega$ pulldown to AGND, $V_{IN} = 0.5V$		200	800	ns
Setup: \overline{CE} to SCLK	t_{SuCe}				100	ns
Setup: DIN to SCLK	t_{SuDi}		100			ns
Hold Time: SCLK to DIN	t_{HdDi}		100			ns
Minimum High Time: SCLK	t_{MnHck}		100			ns
Minimum Low Time: SCLK	t_{MnLck}		100			ns
Minimum Low Time: \overline{UPDATE}	t_{MnLUd}		100			ns
Setup Time: \overline{UPDATE} to SCLK	t_{SuHUd}	Rising edge of \overline{UPDATE} to falling edge of SCLK	100			ns
Hold Time: SCLK to \overline{UPDATE}	t_{HdHUd}	Falling edge of SCLK to falling edge of \overline{UPDATE}	100			ns
Setup Time: MODE to SCLK	t_{SuMd}	Minimum time from clock edge to MODE with valid data clocking	100			ns
Hold Time: MODE to SCLK	t_{HdMd}	Minimum time from clock edge to MODE with valid data clocking	100			ns
Minimum Low Time: \overline{RESET}	t_{MnLRst}				300	ns
Delay: \overline{RESET}	t_{PdRst}	$10k\Omega$ pulldown to AGND, $0.5V$ step			600	ns

Note 1: Associated output voltage may be determined by multiplying the input voltage by the specified gain (A_V) and adding output offset voltage.

Note 2: Logic-level characteristics apply to the following pins: DIN, DOUT, SCLK, \overline{CE} , \overline{UPDATE} , \overline{RESET} , A3–A0, MODE, and \overline{AOUT} .

Note 3: Switching transient settling time is guaranteed by the settling time (t_s) specification. Switching transient is a result of updating the switch matrix.

Note 4: Input test signal: 3.58MHz sine wave of amplitude 40IRE superimposed on a linear ramp (0 to 100IRE). IRE is a unit of video-signal amplitude developed by the International Radio Engineers: 140IRE = 1.0V.

Note 5: All devices are 100% production tested at $T_A = +25^\circ C$. Specifications over temperature limits are guaranteed by design.

16 x 16 Nonblocking Video Crosspoint Switch with I/O Buffers

Symbol Definitions

SYMBOL	TYPE	DESCRIPTION
Ao	Signal	Address Valid Flag (AOUT)
Ce	Signal	Clock Enable (\overline{CE})
Ck	Signal	Clock (SCLK)
Di	Signal	Serial Data In (DIN)
Do	Signal	Serial Data Output (DOUT)
Md	Signal	MODE
Oe	Signal	Output Enable
Rst	Signal	Reset Input (RESET)
Ud	Signal	\overline{UPDATE}
Vo	Signal	Video Out (OUT)
H	Property	High- or Low-to-High Transition
Hd	Property	Hold
L	Property	Low- or High-to-Low Transition
Mn	Property	Minimum
Mx	Property	Maximum
Pd	Property	Propagation Delay
Su	Property	Setup
Tr	Property	Transition
W	Property	Width

Naming Conventions

- All parameters with time units are given a "t" designation, with appropriate subscript modifiers.
- Propagation delays for clocked signals are from the active edge of clock.
- Propagation delay for level-sensitive signals is from input to output at the 50% point of a transition.
- Setup and hold times are measured from the 50% point of signal transition to the 50% point of the clocking signal transition.
- Setup time refers to any signal that must be stable before the active clock edge, even if the signal is not latched or clocked itself.
- Hold time refers to any signal that must be stable during and after active clock edge, even if the signal is not latched or clocked.
- Propagation delays to unobservable internal signals are modified to setup and hold designations applied to observable I/O signals.

16 x 16 Nonblocking Video Crosspoint Switch with I/O Buffers

MAX4355

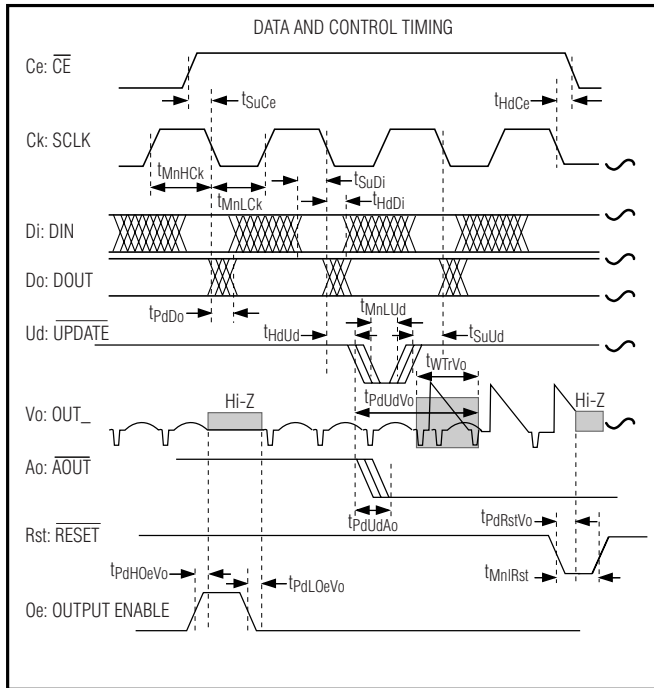

TIMING PARAMETER DEFINITIONS	
NAME	DESCRIPTION
t_{HdDi}	Hold Time: Clock to Data In
t_{MnHck}	Min High Time: Clk
t_{MnLck}	Min Low Time: Clk
t_{MnLud}	Min Low Time: Update
t_{SuHUd}	Setup Time: UPDATE to Clk with UPDATE High
Not Valid	Setup Time: UPDATE to Clk with UPDATE Low
t_{HdHUd}	Hold Time: Clk to UPDATE with UPDATE high
Not Valid	Hold Time: Clk to UPDATE with UPDATE Low
t_{PdDiDo}	Asynchronous Delay: Data In to Data Out
t_{MnMd}	Min Low Time: MODE
t_{MxTr}	Max Rise Time: Clk, Update
t_{MnLrst}	Min Low Time: Reset
$t_{PdRstVo}$	Delay: Reset to Video Output

TIMING PARAMETER DEFINITIONS	
NAME	DESCRIPTION
t_{PdUdVo}	Delay: Update to Video Out
t_{PdUdAo}	Delay: UPDATE to Aout
t_{PdDo}	Delay: Clk to Data Out
t_{PdHoVo}	Delay: Output Enable to Video Output (High: Disable)
t_{PdLoVo}	Delay: Output Enable to Video Output (Low: Enable)
t_{SuCe}	Setup: Clock Enable to Clock
t_{SuDi}	Setup Time: Data In to Clock

Figure 1. Timing Diagram

16x16 Nonblocking Video Crosspoint Switch with I/O Buffers

Typical Operating Characteristics—Dual Supplies $\pm 5V$

($V_{CC} = +5V$ and $V_{EE} = -5V$, $V_{DD} = +5V$, $AGND = DGND = 0$, $V_{IN_L} = 0$, $R_L = 150\Omega$ to $AGND$, and $T_A = +25^\circ C$, unless otherwise noted.)

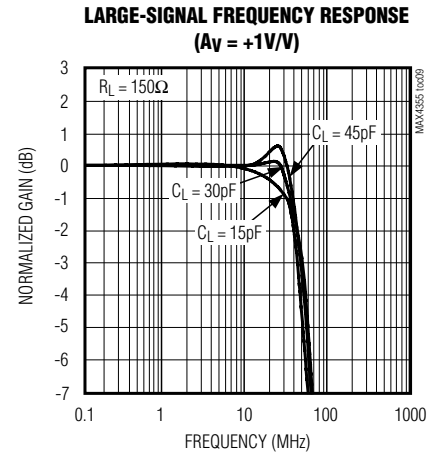
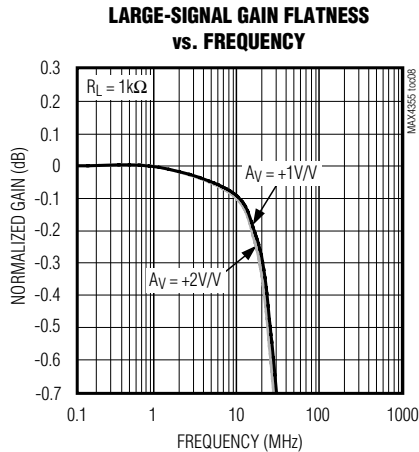
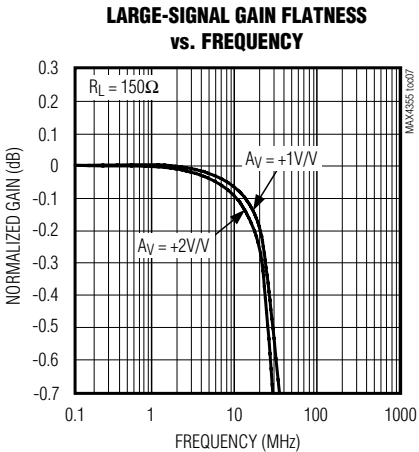
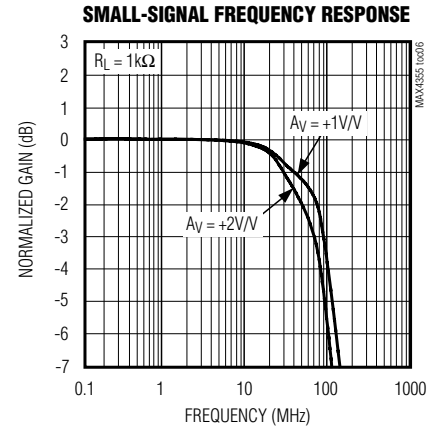
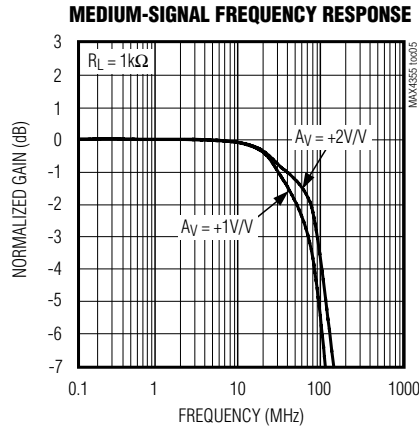
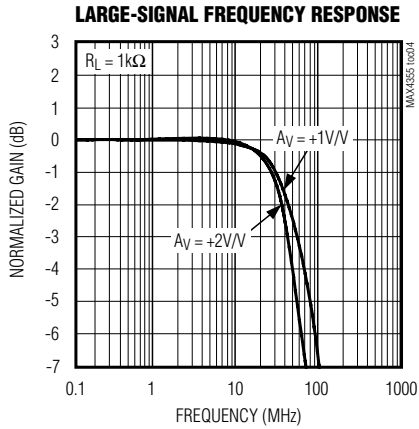
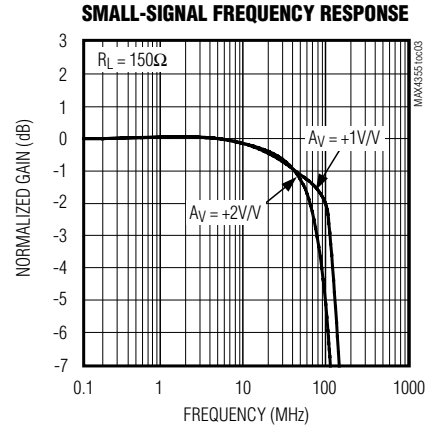
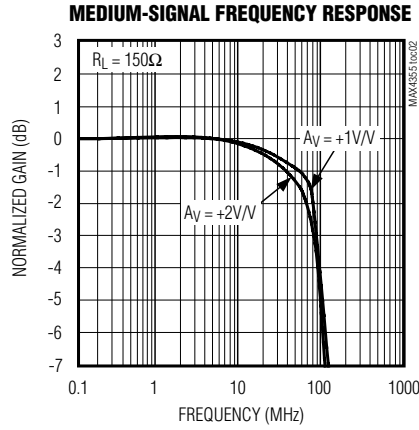
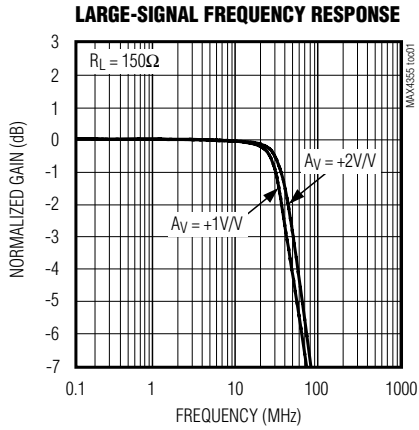

16x16 Nonblocking Video Crosspoint Switch with I/O Buffers

MAX4355

Typical Operating Characteristics—Dual Supplies $\pm 5V$ (continued)

($V_{CC} = +5V$ and $V_{EE} = -5V$, $V_{DD} = +5V$, $AGND = DGND = 0$, $V_{INL} = 0$, $R_L = 150\Omega$ to $AGND$, and $T_A = +25^\circ C$, unless otherwise noted.)

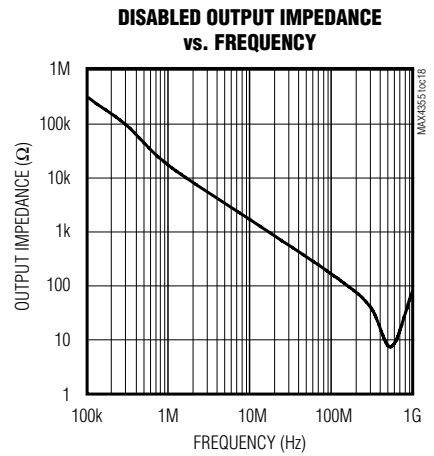
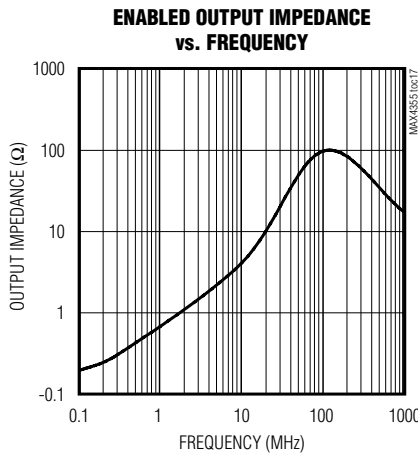
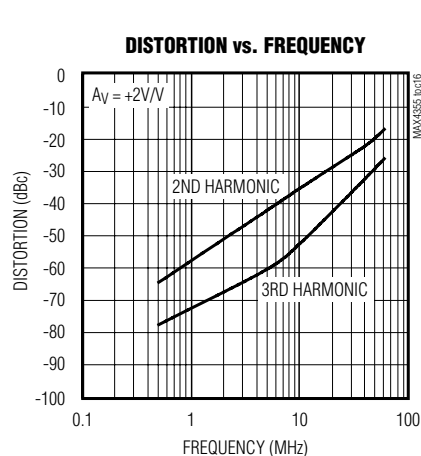
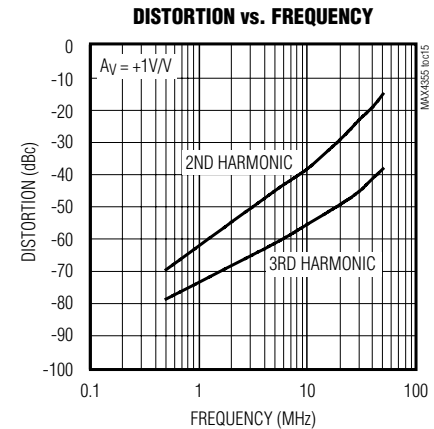
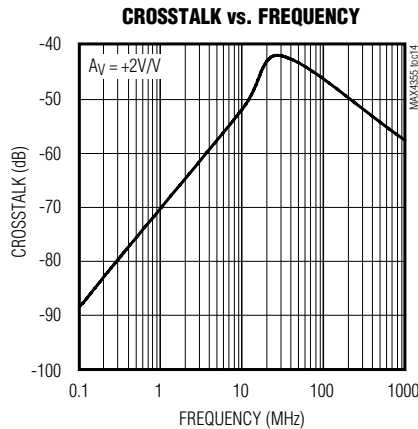
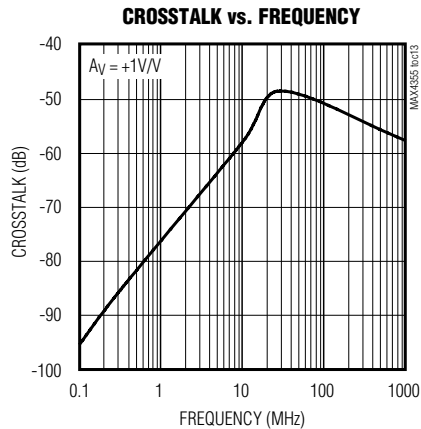
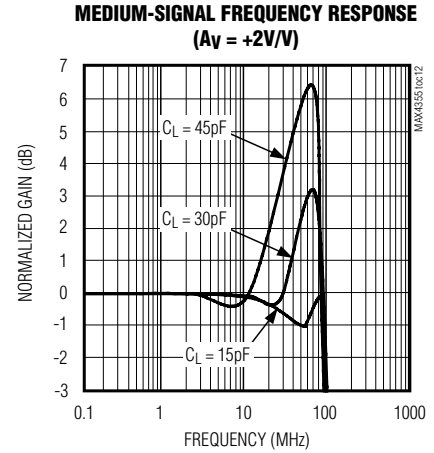
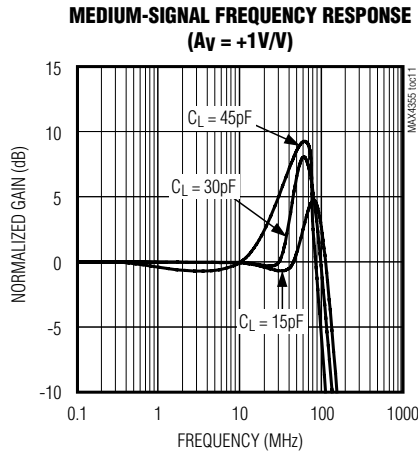
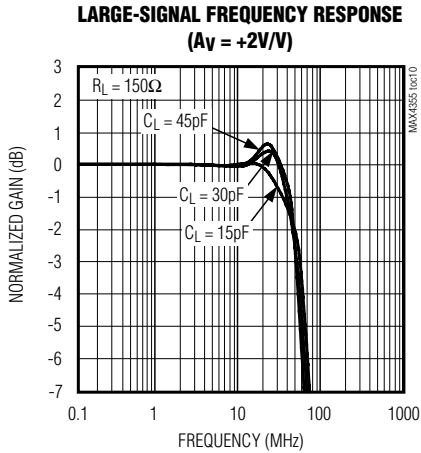

16x16 Nonblocking Video Crosspoint Switch with I/O Buffers

Typical Operating Characteristics—Dual Supplies $\pm 5V$ (continued)

($V_{CC} = +5V$ and $V_{EE} = -5V$, $V_{DD} = +5V$, $AGND = DGND = 0$, $V_{IN_} = 0$, $R_L = 150\Omega$ to $AGND$, and $T_A = +25^\circ C$, unless otherwise noted.)

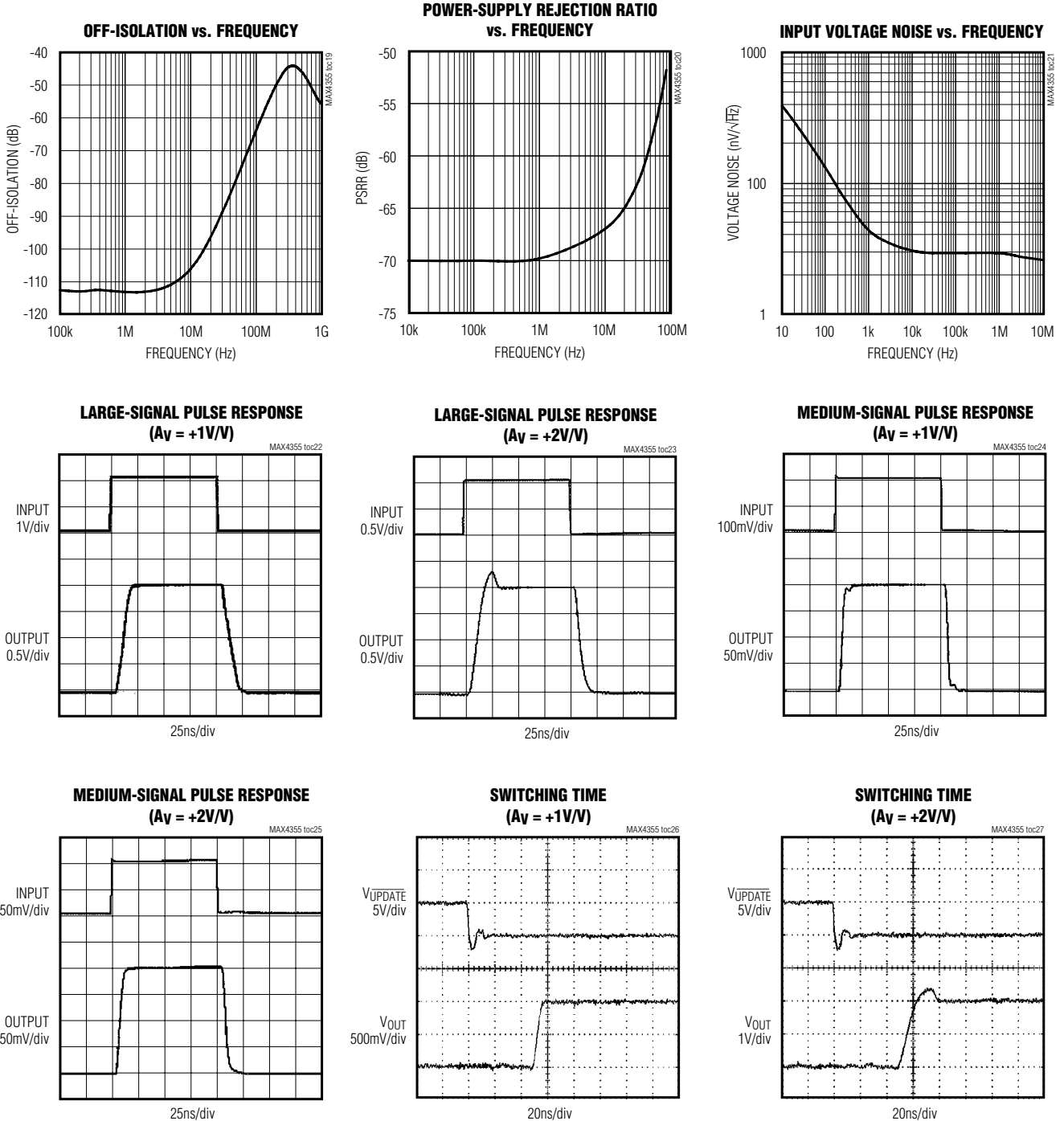

16x16 Nonblocking Video Crosspoint Switch with I/O Buffers

MAX4355

Typical Operating Characteristics—Dual Supplies $\pm 5V$ (continued)

($V_{CC} = +5V$ and $V_{EE} = -5V$, $V_{DD} = +5V$, $AGND = DGND = 0$, $V_{IN_L} = 0$, $R_L = 150\Omega$ to $AGND$, and $T_A = +25^\circ C$, unless otherwise noted.)

SWITCHING TRANSIENT (GLITCH)
($A_V = +1V/V$)

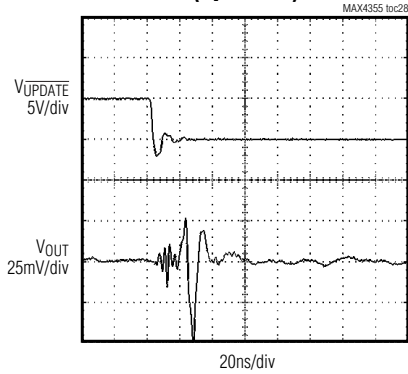

SWITCHING TRANSIENT (GLITCH)
($A_V = +2V/V$)

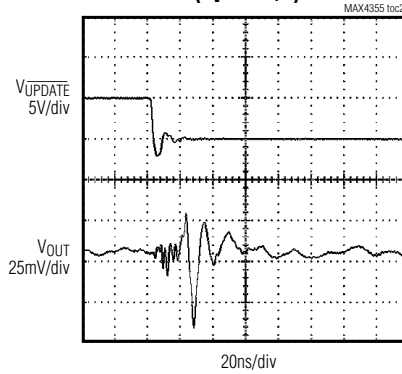

OFFSET VOLTAGE DISTRIBUTION

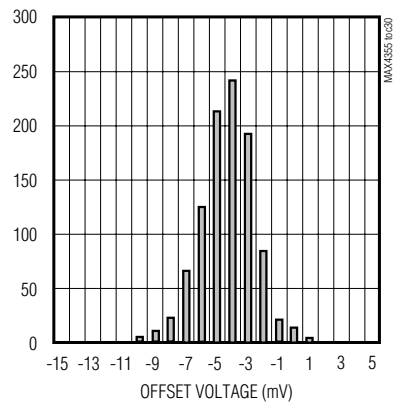

DIFFERENTIAL GAIN AND PHASE
($R_L = 150\Omega$)

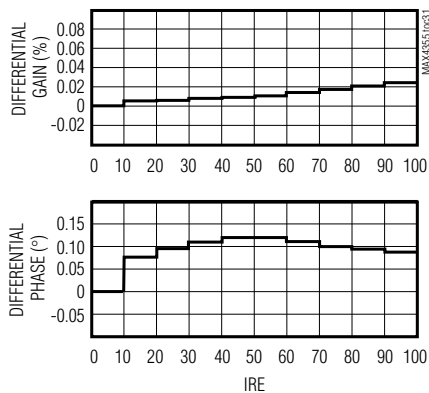

DIFFERENTIAL GAIN AND PHASE
($R_L = 1k\Omega$)

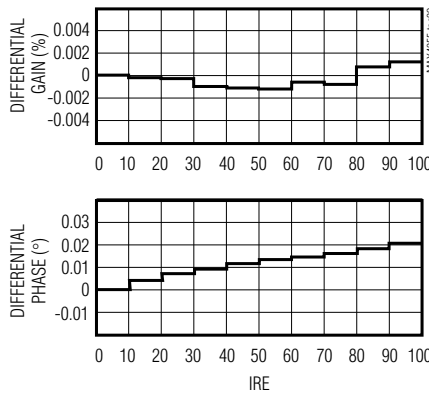

LARGE-SIGNAL PULSE RESPONSE WITH CAPACITIVE LOAD
($C_L = 30pF$, $A_V = +1V/V$)

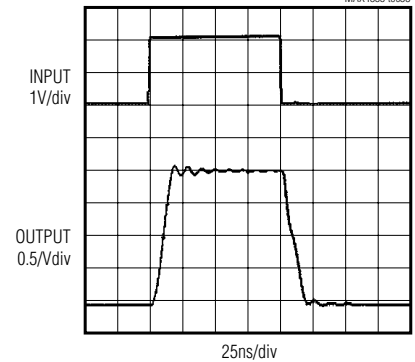

LARGE-SIGNAL PULSE RESPONSE WITH CAPACITIVE LOAD
($C_L = 30pF$, $A_V = +2V/V$)

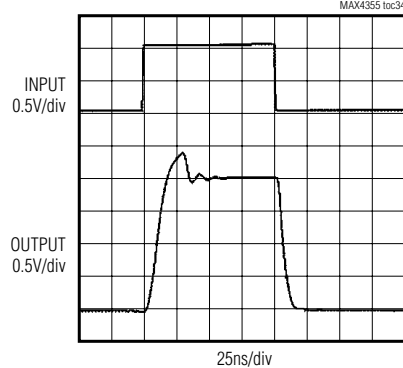

MEDIUM-SIGNAL PULSE RESPONSE WITH CAPACITIVE LOAD
($C_L = 30pF$, $A_V = +1V/V$)

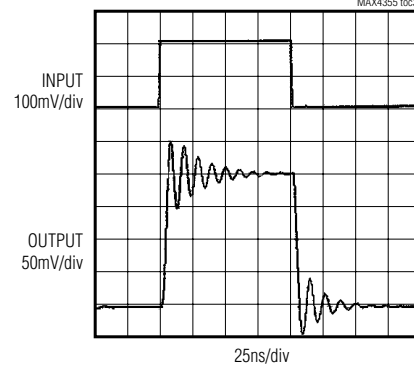

MEDIUM-SIGNAL PULSE RESPONSE WITH CAPACITIVE LOAD
($C_L = 30pF$, $A_V = +2V/V$)

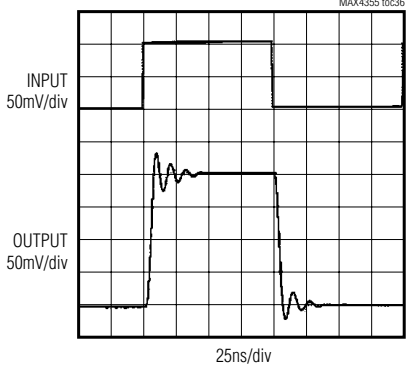

16x16 Nonblocking Video Crosspoint Switch with I/O Buffers

Typical Operating Characteristics—Dual Supplies $\pm 5V$ (continued)

($V_{CC} = +5V$ and $V_{EE} = -5V$, $V_{DD} = +5V$, $AGND = DGND = 0$, $V_{IN_} = 0$, $R_L = 150\Omega$ to $AGND$, and $T_A = +25^\circ C$, unless otherwise noted.)

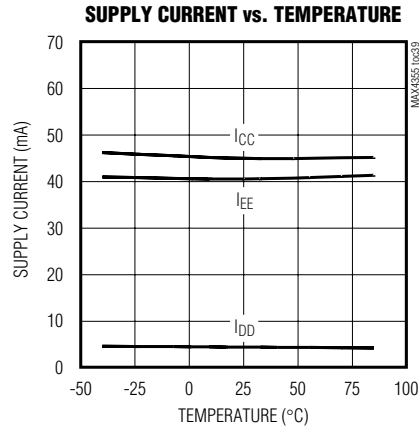
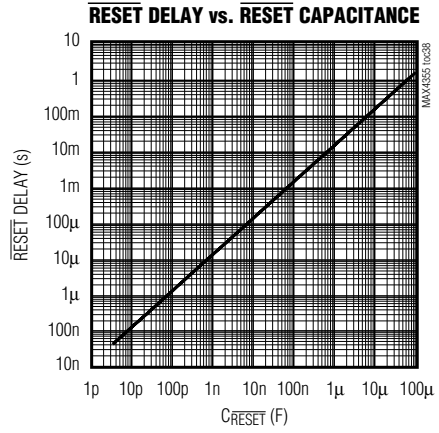
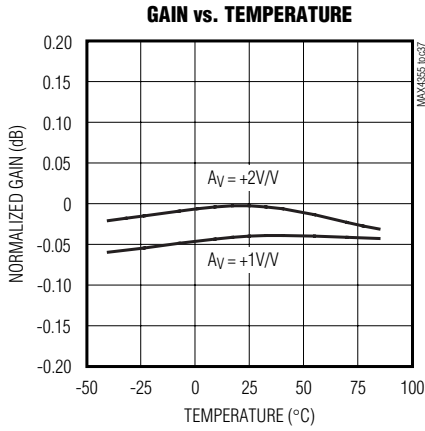

16x16 Nonblocking Video Crosspoint Switch with I/O Buffers

MAX4355

Typical Operating Characteristics—Dual Supplies $\pm 3V$

($V_{CC} = +3V$ and $V_{EE} = -3V$, $V_{DD} = +3V$, $AGND = DGND = 0$, $V_{INL} = 0$, $R_L = 150\Omega$ to $AGND$, and $T_A = +25^\circ C$, unless otherwise noted.)

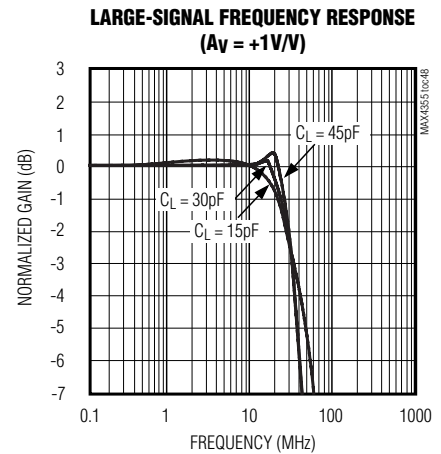
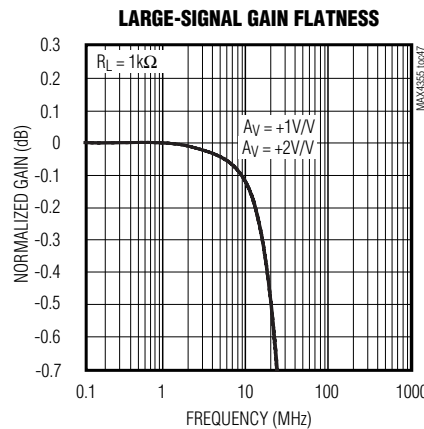
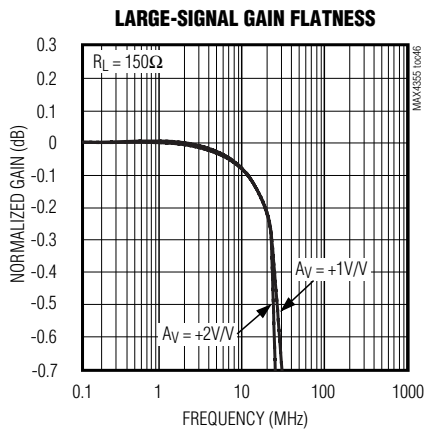
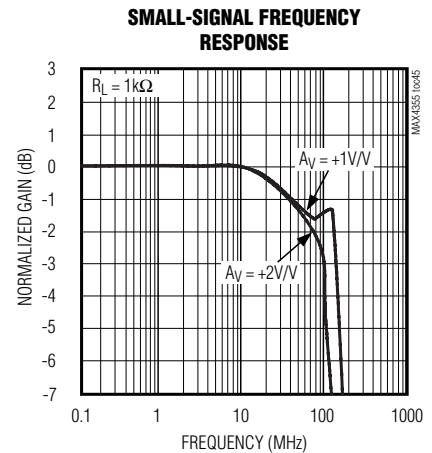
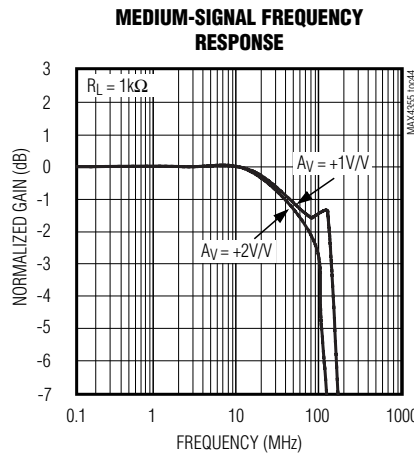
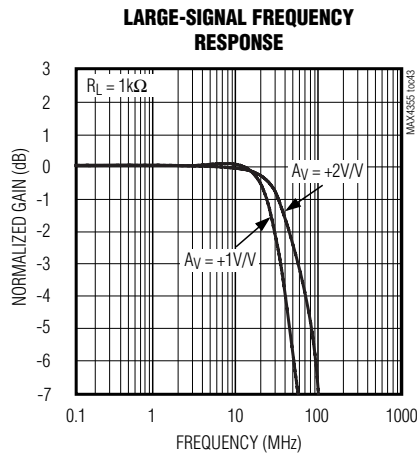
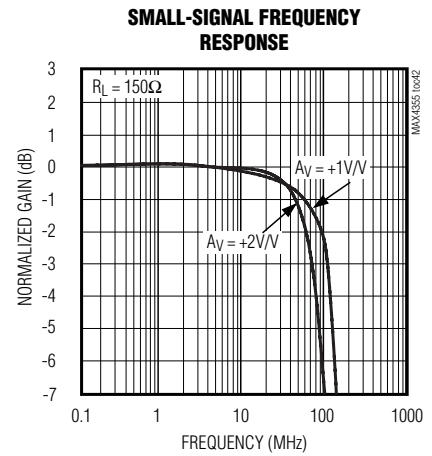
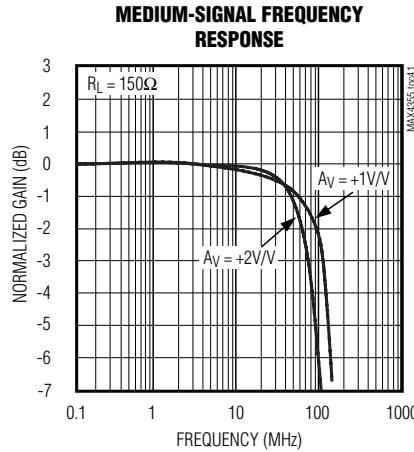
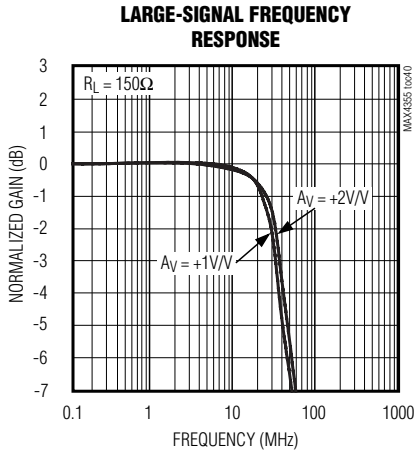

16x16 Nonblocking Video Crosspoint Switch with I/O Buffers

Typical Operating Characteristics—Dual Supplies $\pm 3V$ (continued)

($V_{CC} = +3V$ and $V_{EE} = -3V$, $V_{DD} = +3V$, $AGND = DGND = 0$, $V_{INL} = 0$, $R_L = 150\Omega$ to $AGND$, and $T_A = +25^\circ C$, unless otherwise noted.)

LARGE-SIGNAL FREQUENCY RESPONSE
($A_V = +2V/V$)

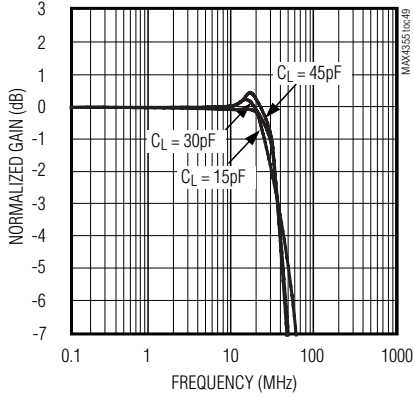

MEDIUM-SIGNAL FREQUENCY RESPONSE
($A_V = +1V/V$)

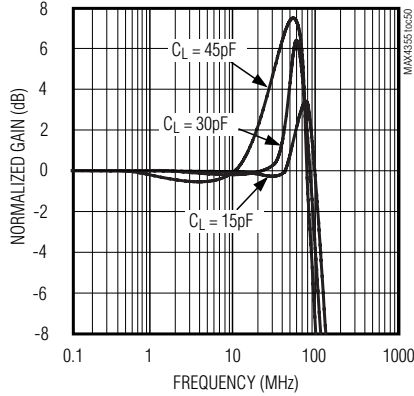

MEDIUM-SIGNAL FREQUENCY RESPONSE
($A_V = +2V/V$)

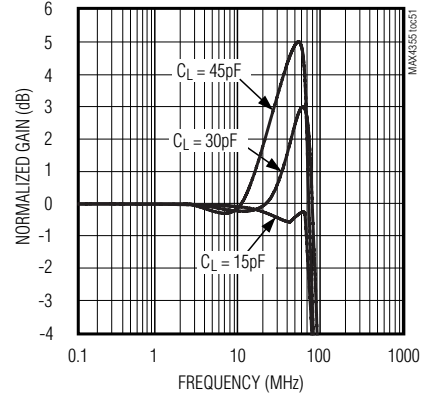

CROSSTALK vs. FREQUENCY

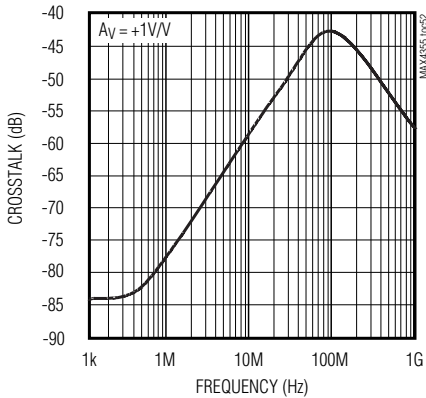

CROSSTALK vs. FREQUENCY

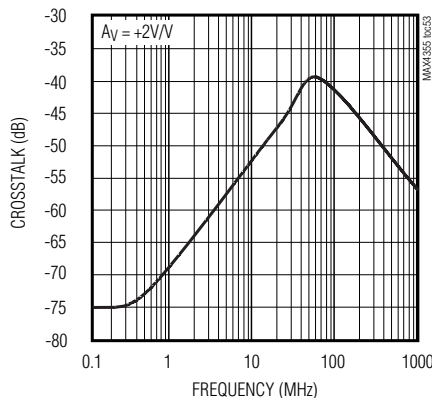

DISTORTION vs. FREQUENCY

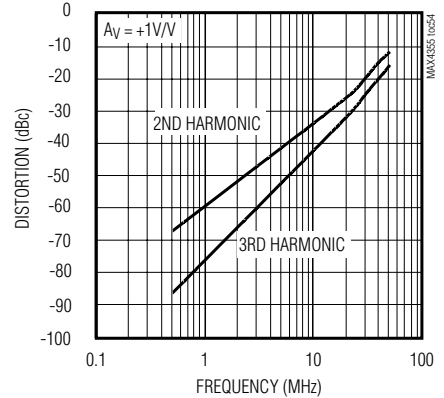

DISTORTION vs. FREQUENCY

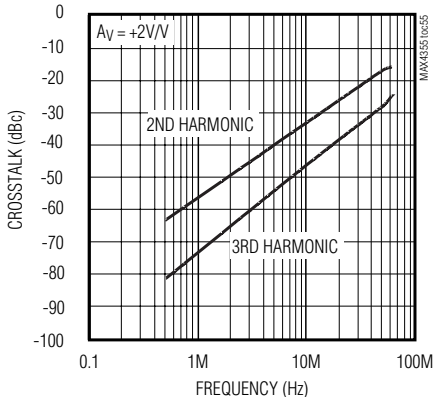

ENABLED OUTPUT IMPEDANCE vs. FREQUENCY

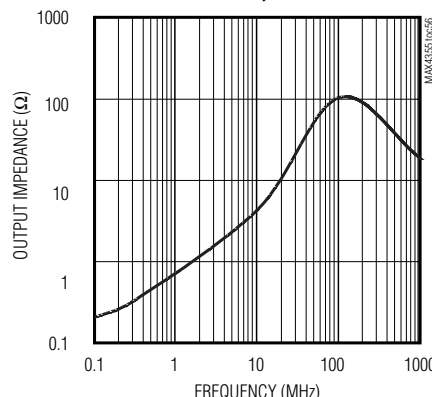

DISABLED OUTPUT IMPEDANCE vs. FREQUENCY

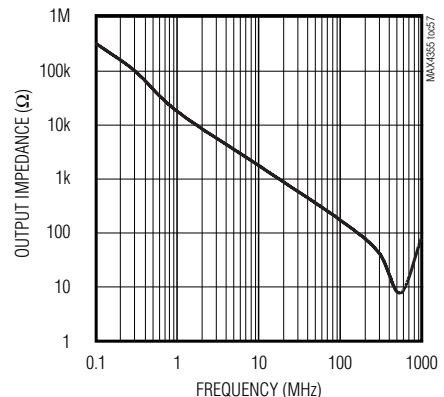

16x16 Nonblocking Video Crosspoint Switch with I/O Buffers

MAX4355

Typical Operating Characteristics—Dual Supplies $\pm 3V$ (continued)

($V_{CC} = +3V$ and $V_{EE} = -3V$, $V_{DD} = +3V$, $AGND = DGND = 0$, $V_{IN_L} = 0$, $R_L = 150\Omega$ to $AGND$, and $T_A = +25^\circ C$, unless otherwise noted.)

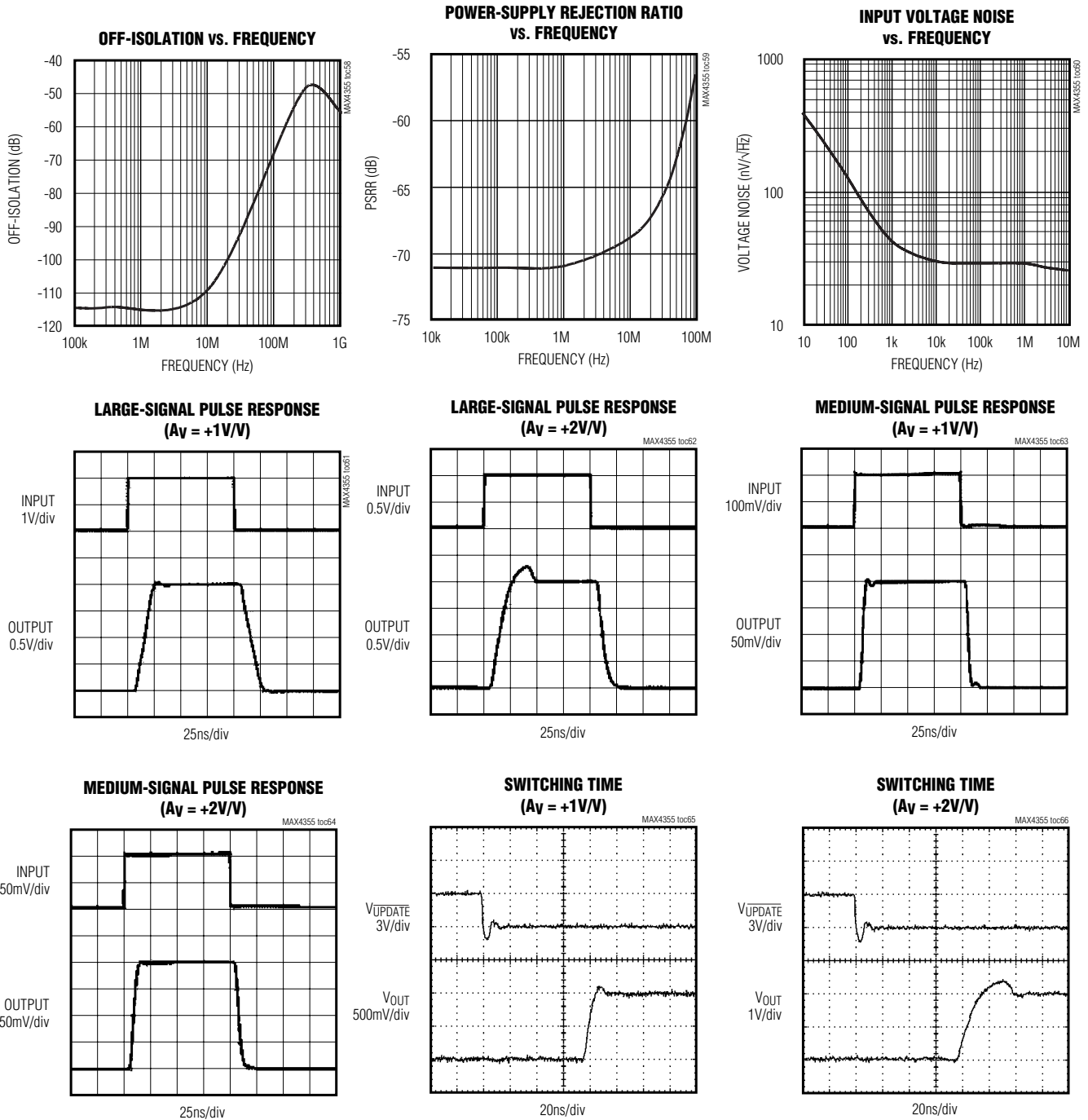

16x16 Nonblocking Video Crosspoint Switch with I/O Buffers

Typical Operating Characteristics—Dual Supplies $\pm 3V$ (continued)

($V_{CC} = +3V$ and $V_{EE} = -3V$, $V_{DD} = +3V$, $AGND = DGND = 0$, $V_{INL} = 0$, $R_L = 150\Omega$ to $AGND$, and $T_A = +25^\circ C$, unless otherwise noted.)

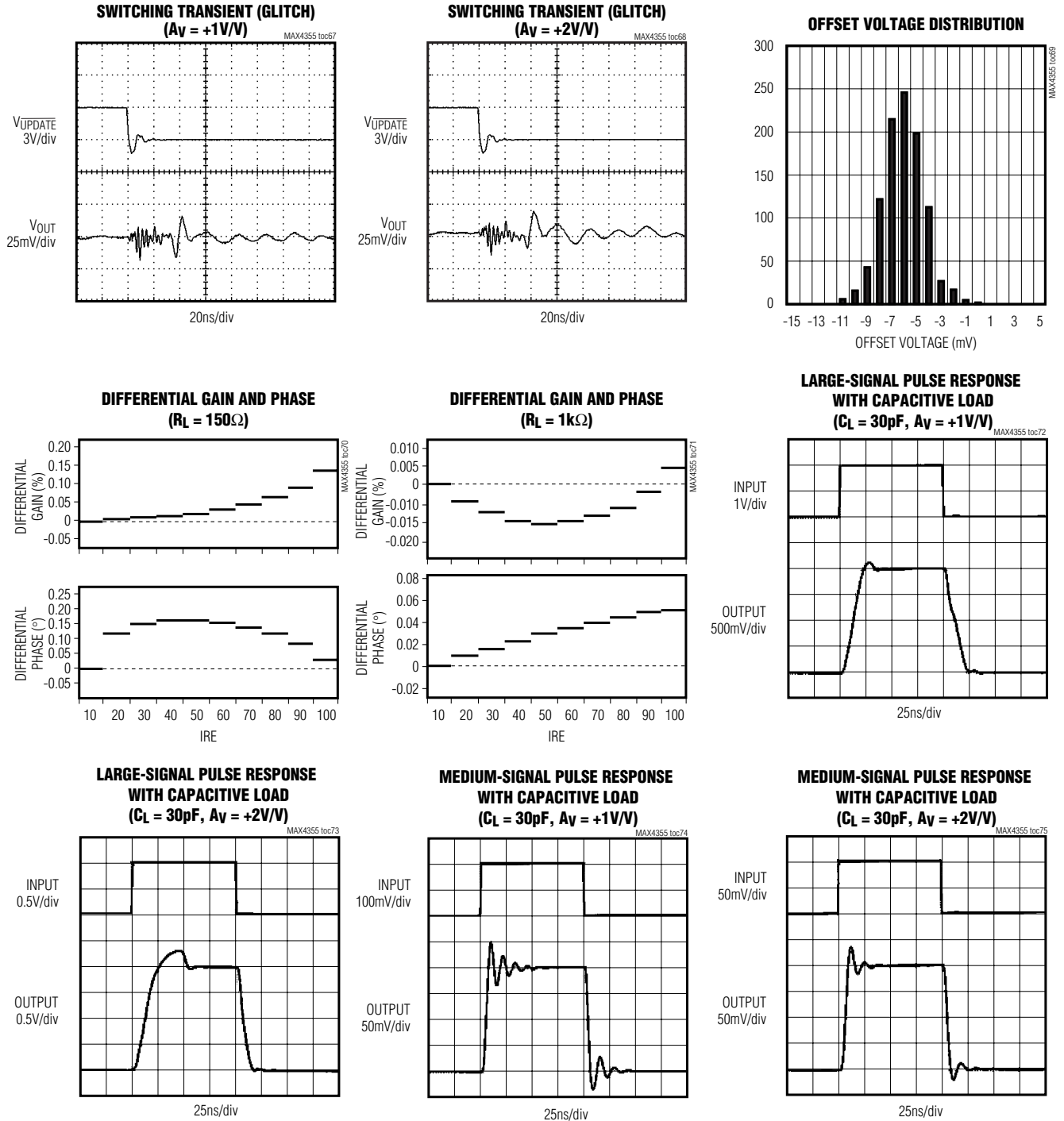

16 x 16 Nonblocking Video Crosspoint Switch with I/O Buffers

Typical Operating Characteristics—Dual Supplies $\pm 3V$ (continued)

($V_{CC} = +3V$ and $V_{EE} = -3V$, $V_{DD} = +3V$, $AGND = DGND = 0$, $V_{IN_L} = 0$, $R_L = 150\Omega$ to $AGND$, and $T_A = +25^\circ C$, unless otherwise noted.)

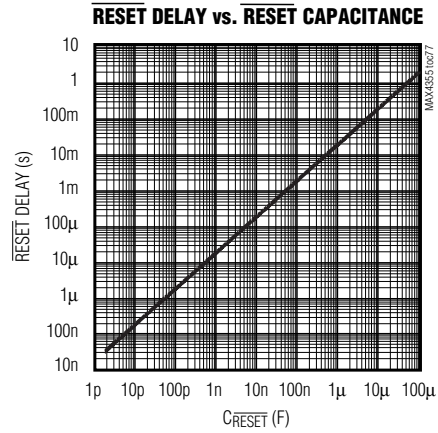
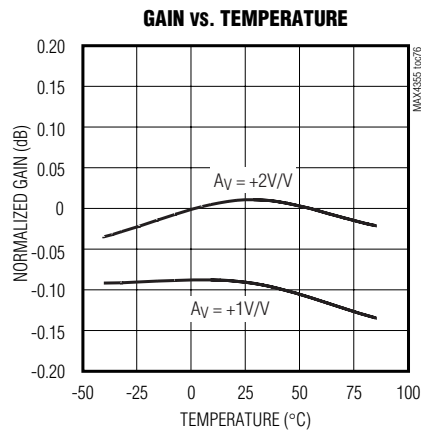

MAX4355

16x16 Nonblocking Video Crosspoint Switch with I/O Buffers

Typical Operating Characteristics—Single Supply +5V

($V_{CC} = +5V$ and $V_{EE} = 0$, $V_{DD} = +5V$, $AGND = DGND = 0$, $V_{IN-} = 0$, $R_L = 150\Omega$ to $AGND$, $A_V = +1V/V$, and $T_A = +25^\circ C$, unless otherwise noted.)

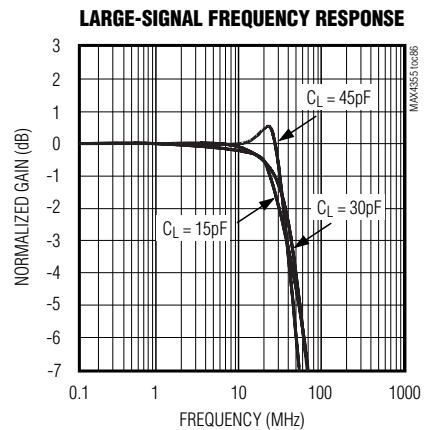
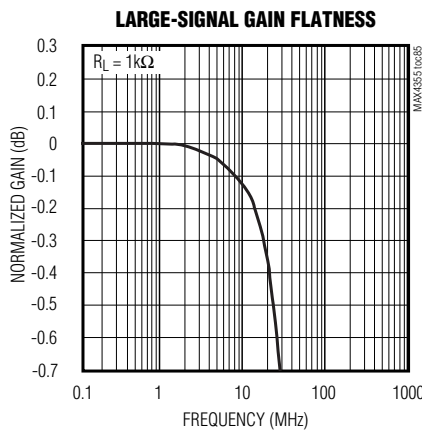
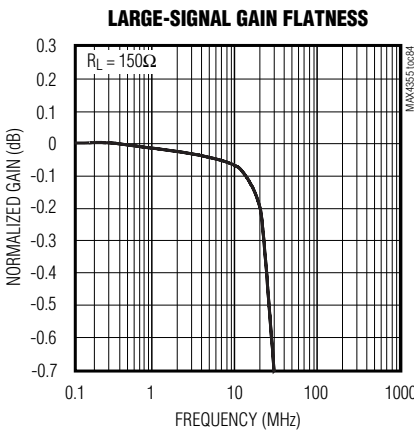
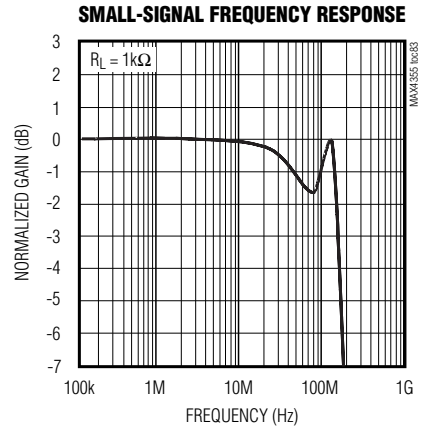
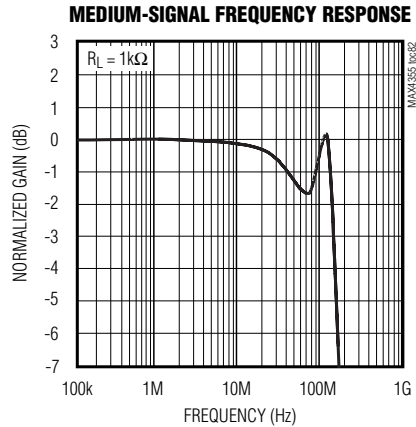
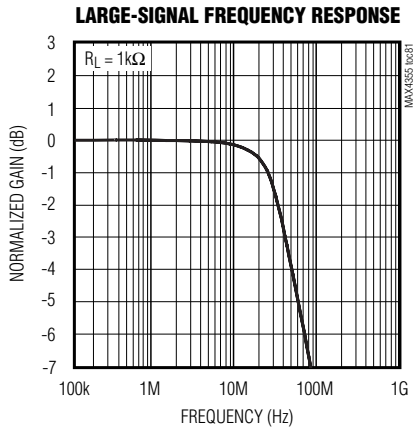
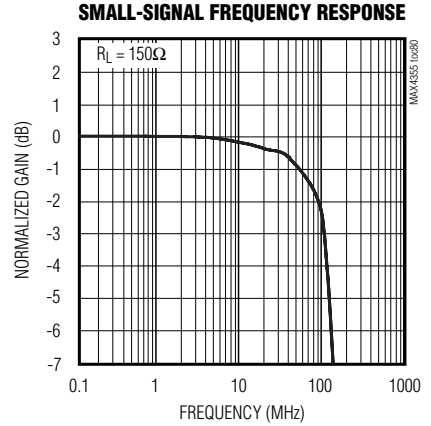
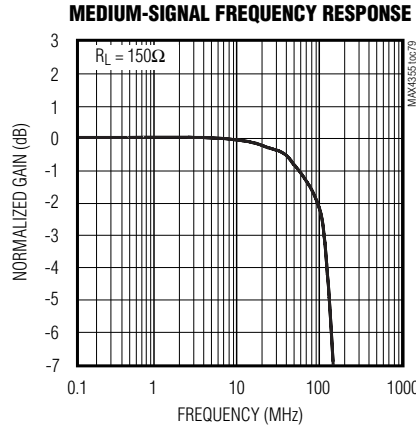
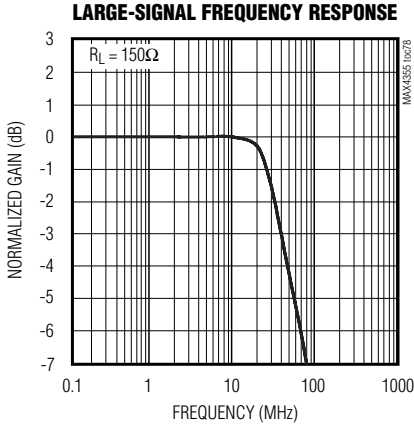

16 x 16 Nonblocking Video Crosspoint Switch with I/O Buffers

MAX4355

Typical Operating Characteristics—Single Supply +5V (continued)

($V_{CC} = +5V$ and $V_{EE} = 0$, $V_{DD} = +5V$, $AGND = DGND = 0$, $V_{IN_} = 0$, $R_L = 150\Omega$ to $AGND$, $A_V = +1V/V$, and $T_A = +25^\circ C$, unless otherwise noted.)

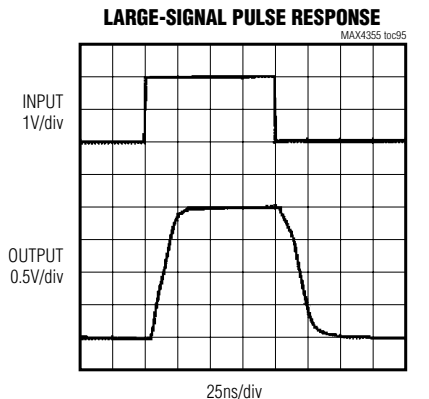
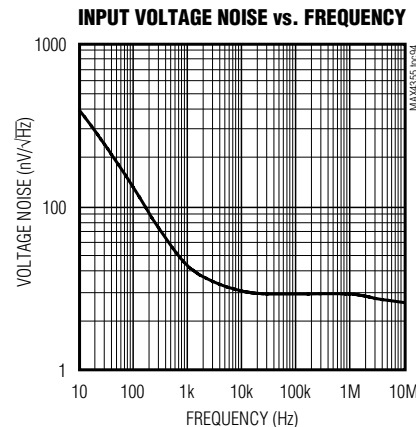
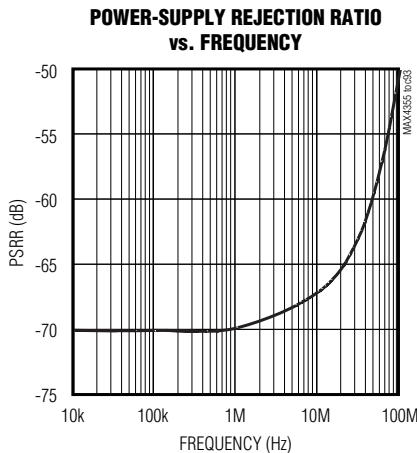
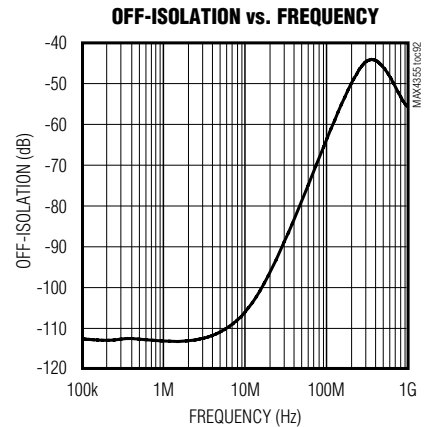
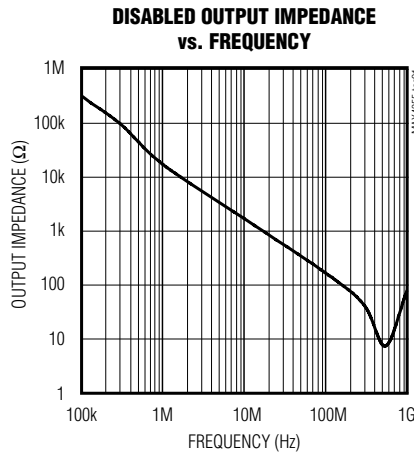
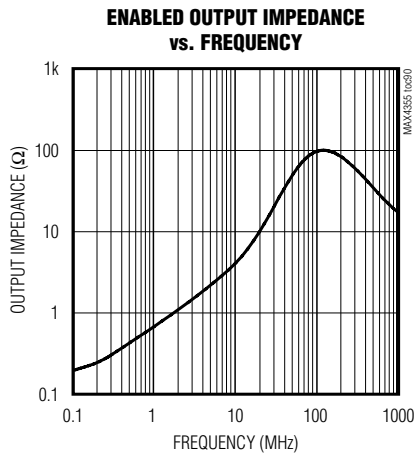
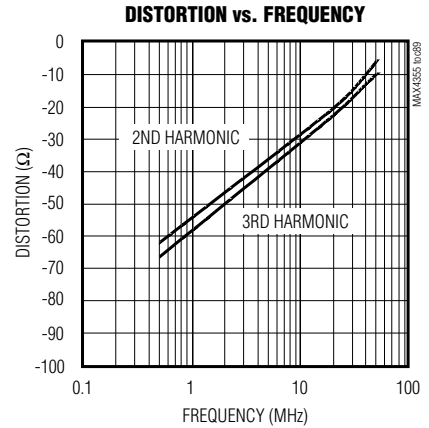
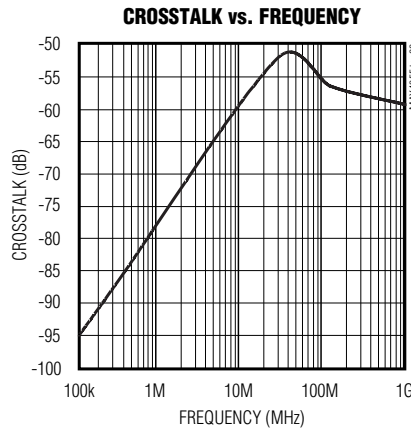
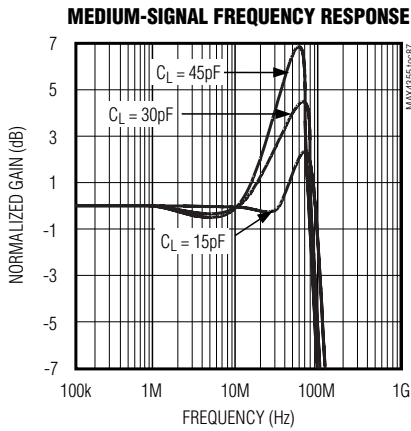

16x16 Nonblocking Video Crosspoint Switch with I/O Buffers

Typical Operating Characteristics—Single Supply +5V (continued)

($V_{CC} = +5V$ and $V_{EE} = 0$, $V_{DD} = +5V$, $AGND = DGND = 0$, $V_{IN-} = 0$, $R_L = 150\Omega$ to $AGND$, $A_V = +1V/V$, and $T_A = +25^\circ C$, unless otherwise noted.)

MEDIUM-SIGNAL PULSE RESPONSE

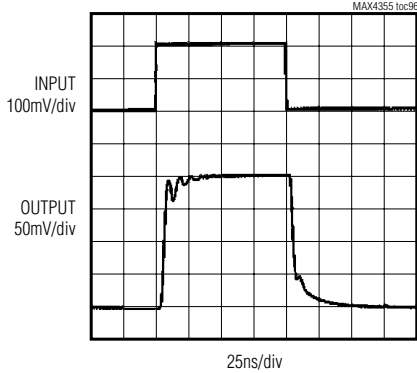

SWITCHING TIME

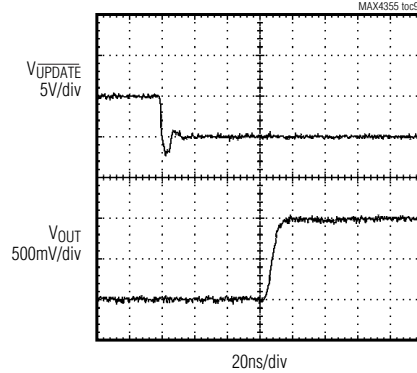

SWITCHING TRANSIENT (GLITCH)

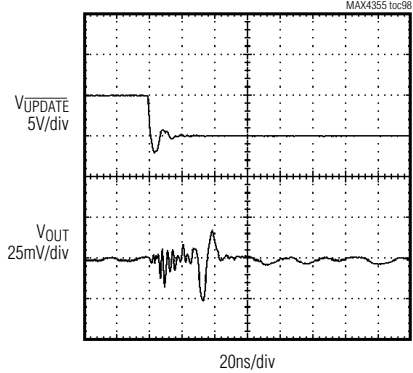

OFFSET VOLTAGE HISTOGRAM

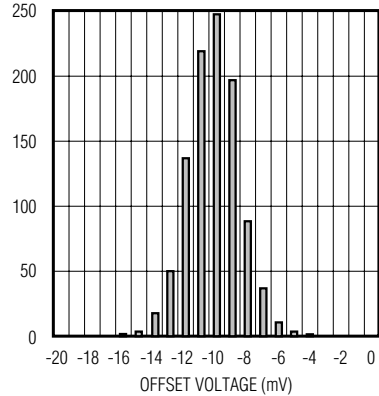

**DIFFERENTIAL GAIN AND PHASE
($R_L = 150\Omega$)**

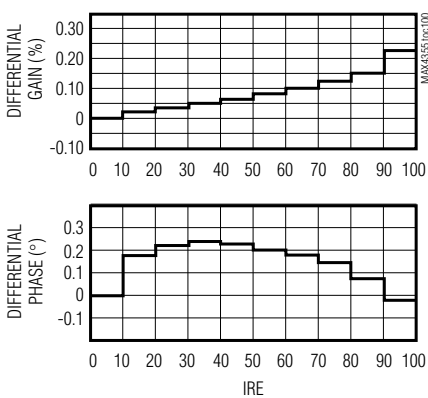

**DIFFERENTIAL GAIN AND PHASE
($R_L = 1k\Omega$)**

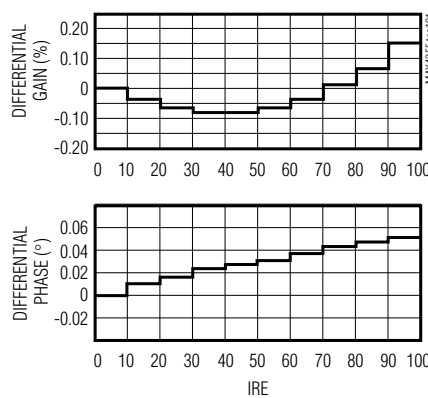

16 x 16 Nonblocking Video Crosspoint Switch with I/O Buffers

MAX4355

Typical Operating Characteristics—Single Supply +5V (continued)

($V_{CC} = +5V$ and $V_{EE} = 0$, $V_{DD} = +5V$, $AGND = DGND = 0$, $V_{IN-} = 0$, $R_L = 150\Omega$ to $AGND$, $A_V = +1V/V$, and $T_A = +25^\circ C$, unless otherwise noted.)

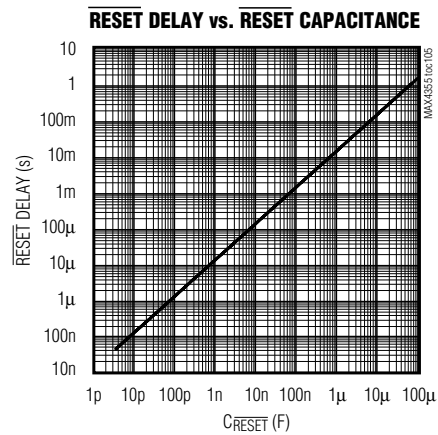
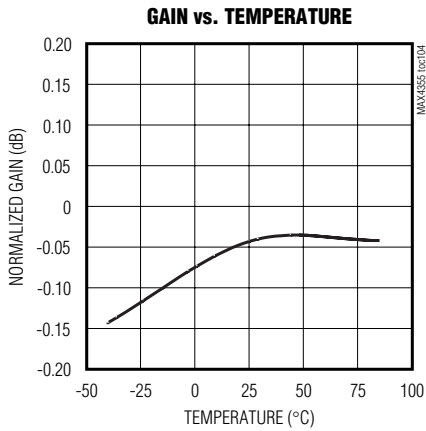
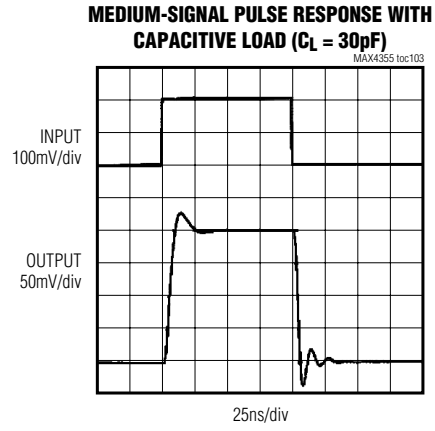
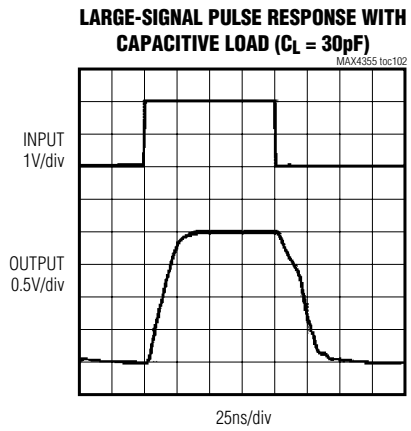

16x16 Nonblocking Video Crosspoint Switch with I/O Buffers

Pin Description

PIN	NAME	FUNCTION
1, 3, 5, 7, 9, 11, 13, 15, 17, 19, 21, 23	IN4-IN15	Buffered Analog Inputs
2, 4, 6, 8, 10, 12, 14, 16, 45, 46, 82, 83, 84, 91, 93, 95, 97	AGND	Analog Ground
18, 20, 22, 24	A3-A0	Address Programming Inputs. Connect to DGND or V _{DD} to select the address for Individual Output Address Mode (see Table 3).
25, 47, 51, 55, 59, 63, 67, 71, 75, 81	V _{CC}	Positive Analog Supply. Bypass each pin with a 0.1μF capacitor to AGND. Connect a single 10μF capacitor from one V _{CC} pin to AGND.
26, 27, 38-44, 76, 77, 85-89, 99, 100	N.C.	No Connection. Not internally connected. Connect to AGND.
28	DOUT	Serial Data Output. In Complete Matrix Mode, data is clocked through the 96-bit Matrix Control shift register. In Individual Output Address Mode, data at DIN passes directly to DOUT.
29	DGND	Digital Ground
30	\overline{AOUT}	Address Recognition Output. \overline{AOUT} drives low after successful chip address recognition.
31	SCLK	Serial Clock Input
32	\overline{CE}	Clock Enable Input. Drive low to enable the serial data interface.
33	MODE	Serial Interface Mode Select Input. Drive high for Complete Matrix Mode (Mode 1) or drive low for Individual Output Address Mode (Mode 0).
34	\overline{RESET}	Asynchronous Reset Input/Output. Drive \overline{RESET} low to initiate hardware reset. All matrix settings are set to power up defaults and all analog outputs are disabled. Additional power-on-reset delay may be set by connecting a small capacitor from \overline{RESET} to DGND.
35	\overline{UPDATE}	Update Input. Drive \overline{UPDATE} low to transfer data from mode registers to the switch matrix.
36	DIN	Serial Data Input. Data is clocked in on the falling edge of SCLK.
37	V _{DD}	Digital Logic Supply. Bypass V _{DD} with a 0.1μF capacitor to DGND.
48, 50, 52, 54, 56, 58, 60, 62, 64, 66, 68, 70, 72, 74, 78, 80	OUT15-OUT0	Buffered Analog Outputs. Gain is individually programmable for A _V = +1V/V or A _V = +2V/V through the serial interface. Outputs may be individually disabled (high impedance). On power-up, or assertion of \overline{RESET} , all outputs are disabled.
49, 53, 57, 61, 65, 69, 73, 79, 98	V _{EE}	Negative Analog Supply. Bypass each pin with a 0.1μF capacitor to AGND. Connect a single 10μF capacitor from one V _{EE} pin to AGND.
90, 92, 94, 96	IN0-IN3	Buffered Analog Inputs

16 x 16 Nonblocking Video Crosspoint Switch with I/O Buffers

Functional Diagram

MAX4355

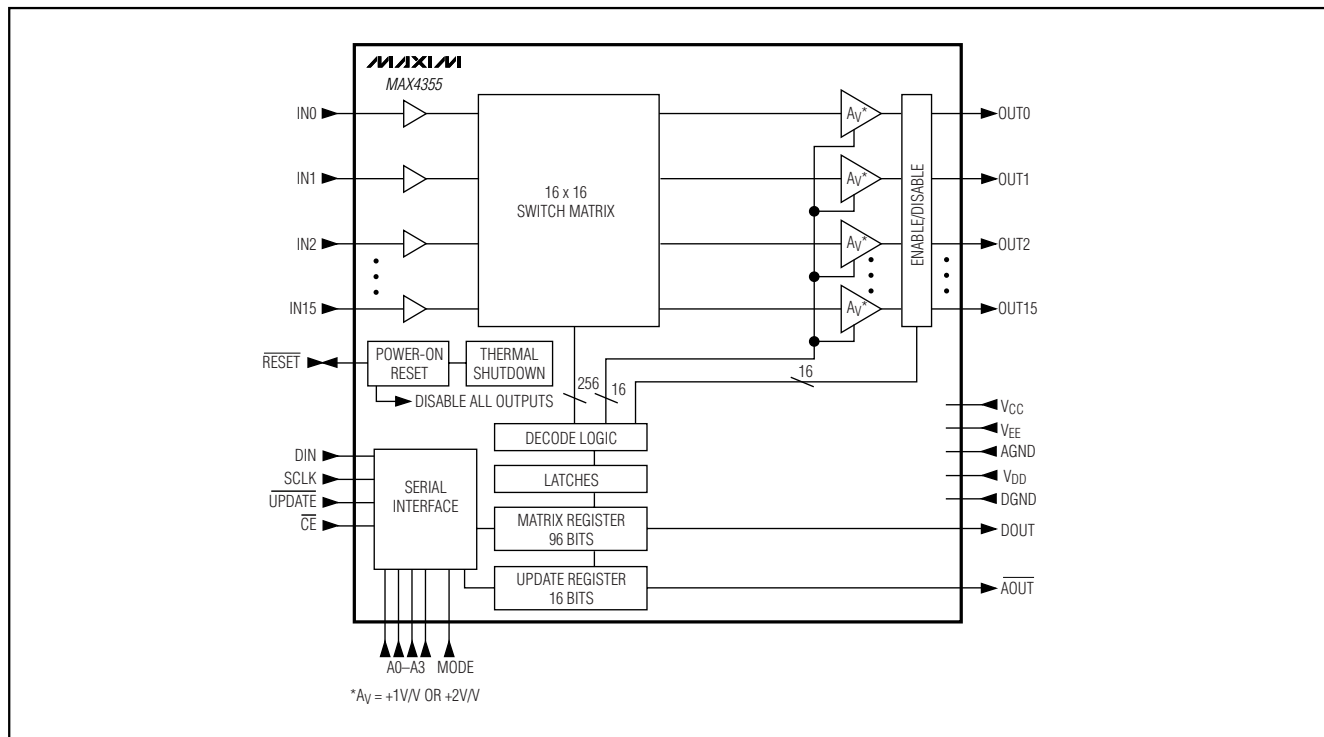

Detailed Description

The MAX4355 is a highly integrated 16×16 nonblocking video crosspoint switch matrix. All inputs and outputs are buffered, with all outputs able to drive standard 75Ω reverse-terminated video loads.

A 3-wire interface programs the switch matrix and initializes with a single update signal. The unique serial interface operates in one of two modes: Complete Matrix Mode (Mode 1) or Individual Output Address Mode (Mode 0).

In the *Functional Diagram*, the signal path of the MAX4355 is from the inputs (IN0–IN15), through the switching matrix, buffered by the output amplifiers, and presented at the output terminals (OUT0–OUT15). The other functional blocks are the serial interface and control logic. Each of the functional blocks is described in detail below.

Analog Outputs

The MAX4355 outputs are high-speed voltage feedback amplifiers capable of driving 150Ω (75Ω back-terminated) loads. The gain, $A_v = +1V/V$ or $+2V/V$, is selectable through programming bit 4 of the serial control word. Amplifier compensation is automatically opti-

mized to maximize the bandwidth for each gain selection. Each output can be individually enabled and disabled through bit 5 of the serial control word. When disabled, the output is high impedance, presenting typically a $4k\Omega$ load, and $3pF$ output capacitance, allowing multiple outputs to be connected together in building large arrays. On power-up (or asynchronous RESET), all outputs are initialized in the disabled state to avoid output conflicts in large-array configurations. The programming and operation of the MAX4355 is output referred. Outputs are configured individually to connect to any one of the 16 analog inputs, programmed to the desired gain ($A_v = +1V/V$ or $+2V/V$), or disabled in a high-impedance state.

Analog Inputs

The MAX4355 offers 16 analog input channels. Each input is buffered before the crosspoint switch matrix, allowing one input to cross-connect to up to 16 outputs. The input buffers are voltage feedback amplifiers with high-input impedance and low-input bias current. This allows the use of very simple input clamp circuits.

16 x 16 Nonblocking Video Crosspoint Switch with I/O Buffers

Table 1. Operation Truth Table

$\overline{\text{CE}}$	$\overline{\text{UPDATE}}$	SCLK	DIN	DOUT	MODE	$\overline{\text{AOUT}}$	$\overline{\text{RESET}}$	OPERATION/COMMENTS
1	X	X	X	X	X	X	1	No change in logic.
0	1	↓	D _i	D _{i-96}	1	1	1	Data at DIN is clocked on the negative edge of the SCLK into the 96-bit Complete Matrix Mode register. DOUT supplies original data in 96 SCLK pulses later.
0	0	X	X	X	1	1	1	Data in the serial 96-bit Complete Matrix Mode register is transferred into parallel latches that control the switching matrix.
0	1	↓	D _i	D _i	0	1	1	Data at DIN is routed to the Individual Output Address Mode shift register. DIN is also connected directly to DOUT so that all devices on the serial bus may be addressed in parallel.
0	0	X	D _i	D _i	0	0	1	The 4-bit chip address A ₃ to A ₀ is compared to D ₁₃ to D ₁₀ . If equal, the remaining 10 bits in the Individual Output Address Mode register are decoded, allowing reprogramming for a single output. AOUT signals a successful individual matrix update.
X	X	X	X	X	X	X	0	Asynchronous reset. All outputs are disabled. Other logic remains unchanged.

Switch Matrix

The MAX4355 has 256 individual T-switches making a 16 x 16 switch matrix. The switching matrix is 100% nonblocking, which means that any input may be routed to any output. The switch matrix programming is output referred. Each output may be connected to any one of the 16 analog inputs. Any one input can be routed to all 16 outputs with no signal degradation.

Digital Interface

The digital interface consists of the following pins: DIN, DOUT, SCLK, AOUT, UPDATE, CE, A3–A0, MODE, and RESET. DIN is the serial data input; DOUT is the serial data output. SCLK is the serial data clock that clocks data into the Data Input registers (Figure 2). Data at DIN is loaded at each falling edge of SCLK. DOUT is the data shifted out of the 96-bit Complete Matrix Mode (Mode = 1). DIN passes directly to DOUT when in Individual Output Address Mode (Mode = 0).

The falling edge of $\overline{\text{UPDATE}}$ latches the data and programs the matrix. When using Individual Output Address Mode, the address recognition output $\overline{\text{AOUT}}$ drives low when control word bits D₁₃ to D₁₀ match the address programming inputs (A₃–A₀) and UPDATE is low. Table 1 is the operation truth table.

Programming the Matrix

The MAX4355 offers two programming modes: Individual Output Address Mode and Complete Matrix Mode. These two distinct programming modes are selected by toggling a single MODE pin high or low. Both modes operate with the same physical board layout. This flexibility allows initial programming of the IC by daisy-chaining and sending one long data word while still being able to address immediately and update individual outputs in the matrix.

Individual Output Address Mode (MODE = 0)

Drive MODE to logic low to select mode 0. Individual outputs are programmed through the serial interface

16 x 16 Nonblocking Video Crosspoint Switch with I/O Buffers

MAX4355

Table 2. 16-Bit Serial Control Word Bit Assignments (Mode 0: Individual Output Address Mode)

BIT	NAME	FUNCTION
0 (LSB)	Input Address 0	LSB of input channel select address
1	Input Address 1	
2	Input Address 2	
3	Input Address 3	MSB of input channel select address
4	Gain Set	Gain Select for output buffer, 0 = gain of +1V/V, 1 = gain of +2V/V
5	Output Enable	Enable bit for output, 0 = disable, 1 = enable
6	Output Address B0	LSB of output buffer address
7	Output Address B1	
8	Output Address B2	
9	Output Address B3	MSB of output buffer address
10	IC Address A0	LSB of selected chip address
11	IC Address A1	
12	IC Address A2	
13	IC Address A3	MSB of selected chip address
14	X	Don't care
15 (MSB)	X	Don't care

with a single 16-bit control word. The control word consists of two don't care MSBs, the chip address bits, output address bits, an output enable/disable bit, an output gain-set bit, and input address bits (Tables 2 through 6, and Figure 2).

In mode 0, data at DIN passes directly to DOUT through the data routing gate (Figure 3). In this configuration, the 16-bit control word is simultaneously sent to all chips in an array of up to 16 addresses.

Complete Matrix Mode (MODE = 1)

Drive MODE to logic high to select mode 1. A single 96-bit control word consisting of sixteen 6-bit control words programs all outputs. The 96-bit control word's

Table 3. Chip Address Programming for 16-Bit Control Word (Mode 0: Individual Output Address Mode)

IC ADDRESS BIT				ADDRESS	
A3 (MSB)	A2	A1	A0 (LSB)	CHIP ADDRESS (HEX)	CHIP ADDRESS (DECIMAL)
0	0	0	0	0h	0
0	0	0	1	1h	1
0	0	1	0	2h	2
0	0	1	1	3h	3
0	1	0	0	4h	4
0	1	0	1	5h	5
0	1	1	0	6h	6
0	1	1	1	7h	7
1	0	0	0	8h	8
1	0	0	1	9h	9
1	0	1	0	Ah	10
1	0	1	1	Bh	11
1	1	0	0	Ch	12
1	1	0	1	Dh	13
1	1	1	0	Eh	14
1	1	1	1	Fh	15

first 6-bit control word (MSBs) programs output 15, and the last 6-bit control word (LSBs) programs output 0 (Table 7 and Figures 4 and 5). Data clocked into the 96-bit Complete Matrix Mode register is latched on the falling edge of UPDATE, and the outputs are immediately updated.

Initialization String

The Complete Matrix Mode (Mode = 1) is convenient to use to program the matrix at power-up. In a large matrix consisting of many MAX4355 devices, all the devices can be programmed by sending a single bit stream equal to $n \times 96$ bits, where n is the number of MAX4355 devices on the bus. The first 96-bit data word programs the last MAX4355 in line (see *Matrix Programming* section).

RESET

The MAX4355 features an asynchronous bidirectional RESET with an internal 20kΩ pullup resistor to VDD. When RESET is pulled low, either by internal circuitry, or driven externally, the analog output buffers are latched into a high-impedance state. After RESET is

16x16 Nonblocking Video Crosspoint Switch with I/O Buffers

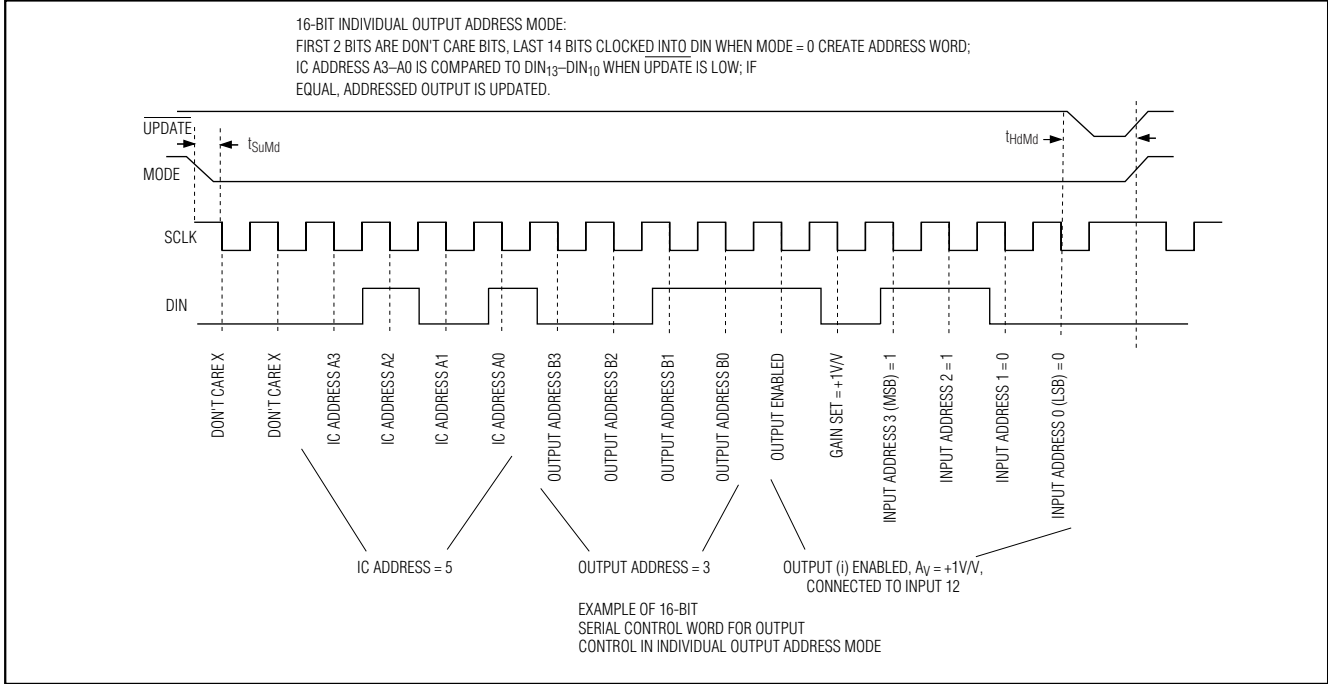

Figure 2. Mode 0: Individual Output Address Mode Timing and Programming Example

Table 4. Chip Address A3–A0 Pin Programming

PIN				ADDRESS	
A3	A2	A1	A0	CHIP ADDRESS (HEX)	CHIP ADDRESS (DECIMAL)
DGND	DGND	DGND	DGND	0h	0
DGND	DGND	DGND	V _{DD}	1h	1
DGND	DGND	V _{DD}	DGND	2h	2
DGND	DGND	V _{DD}	V _{DD}	3h	3
DGND	V _{DD}	DGND	DGND	4h	4
DGND	V _{DD}	DGND	V _{DD}	5h	5
DGND	V _{DD}	V _{DD}	DGND	6h	6
DGND	V _{DD}	V _{DD}	V _{DD}	7h	7
V _{DD}	DGND	DGND	DGND	8h	8
V _{DD}	DGND	DGND	V _{DD}	9h	9
V _{DD}	DGND	V _{DD}	DGND	Ah	10
V _{DD}	DGND	V _{DD}	V _{DD}	Bh	11
V _{DD}	V _{DD}	DGND	DGND	Ch	12
V _{DD}	V _{DD}	DGND	V _{DD}	Dh	13
V _{DD}	V _{DD}	V _{DD}	DGND	Eh	14
V _{DD}	V _{DD}	V _{DD}	V _{DD}	Fh	15

Table 5. Output Selection Programming

OUTPUT ADDRESS BIT				SELECTED OUTPUT
B3 (MSB)	B2	B1	B0 (LSB)	
0	0	0	0	0
0	0	0	1	1
0	0	1	0	2
0	0	1	1	3
0	1	0	0	4
0	1	0	1	5
0	1	1	0	6
0	1	1	1	7
1	0	0	0	8
1	0	0	1	9
1	0	1	0	10
1	0	1	1	11
1	1	0	0	12
1	1	0	1	13
1	1	1	0	14
1	1	1	1	15

16 x 16 Nonblocking Video Crosspoint Switch with I/O Buffers

MAX4355

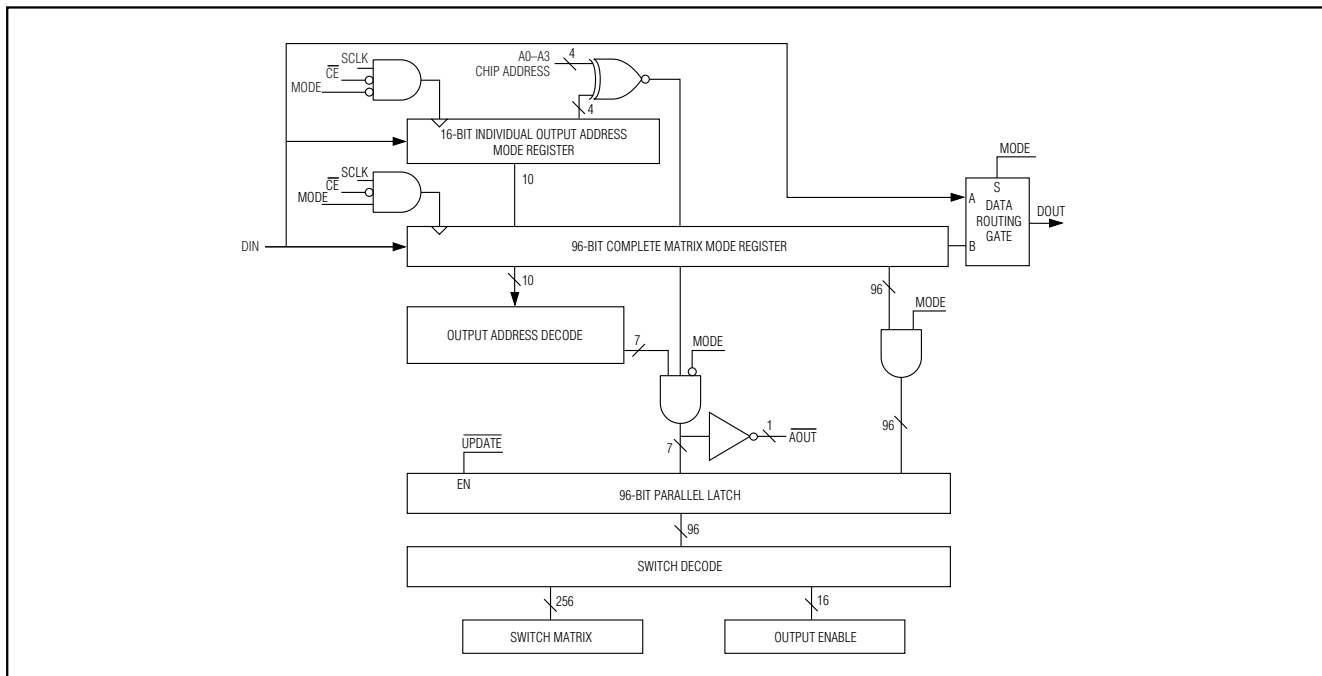

Figure 3. Serial Interface Block Diagram

Table 6. Input Selection Programming

INPUT ADDRESS BIT				SELECTED INPUT
B3 (MSB)	B2	B1	B0 (LSB)	
0	0	0	0	0
0	0	0	1	1
0	0	1	0	2
0	0	1	1	3
0	1	0	0	4
0	1	0	1	5
0	1	1	0	6
0	1	1	1	7
1	0	0	0	8
1	0	0	1	9
1	0	1	0	10
1	0	1	1	11
1	1	0	0	12
1	1	0	1	13
1	1	1	0	14
1	1	1	1	15

Table 7. 6-Bit Serial Control Word Bit Assignments (Mode 1: Complete Matrix Mode)

BIT	NAME	FUNCTION
5 (MSB)	Output Enable	Enable bit for output, 0 = disable, 1 = enable
4	Gain Set	Gain Select for output buffer, 0 = gain of +1V/V, 1 = gain of +2V/V
3	Input Address 3	MSB of input channel select address
2	Input Address 2	
1	Input Address 1	
0 (LSB)	Input Address 0	LSB of input channel select address

16 x 16 Nonblocking Video Crosspoint Switch with I/O Buffers

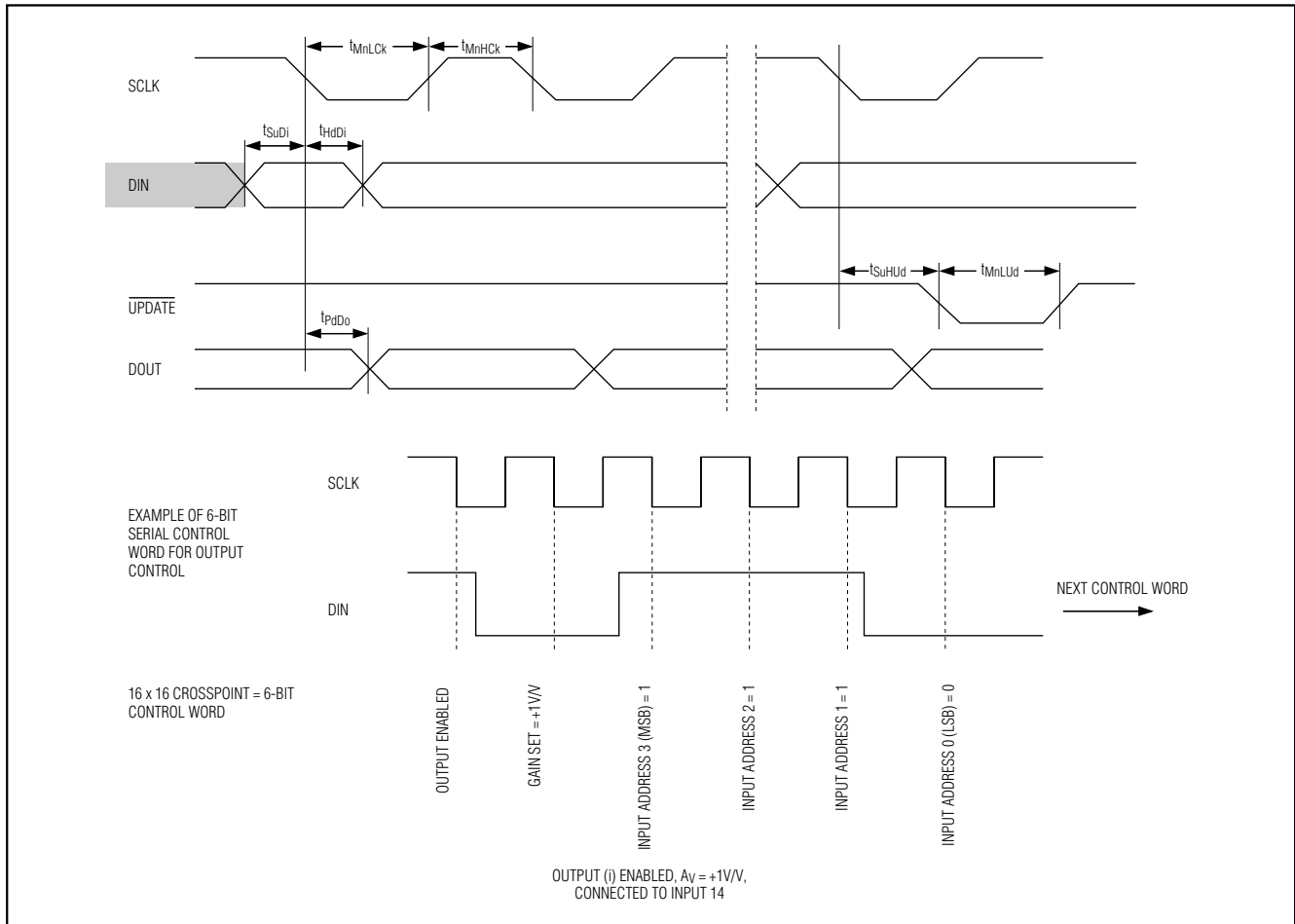

Figure 4. 6-Bit Control Word and Programming Example (Mode 1: Complete Matrix Mode Programming)

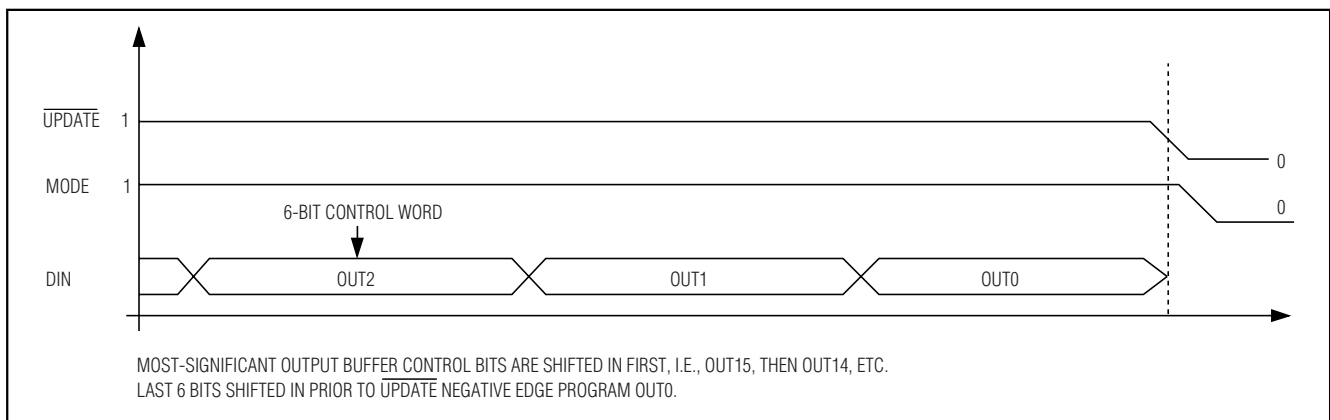

Figure 5. Mode 1: Complete Matrix Mode Programming

16 x 16 Nonblocking Video Crosspoint Switch with I/O Buffers

released, the output buffers remain disabled. The outputs may be enabled by sending a new 96-bit data word or a 16-bit individual output address word. A reset is initiated from any of three sources. $\overline{\text{RESET}}$ can be driven low by external circuitry to initiate a reset, or $\overline{\text{RESET}}$ can be pulled low by internal circuitry during power-up (power-on reset) or thermal shutdown.

Since driving $\overline{\text{RESET}}$ low only clears the output buffer enable bit in the matrix control latches, $\overline{\text{RESET}}$ can be used to disable all outputs simultaneously. If no new data has been loaded into the 96-bit complete matrix mode register, a single $\overline{\text{UPDATE}}$ restores the previous matrix control settings.

Power-On Reset

The power-on reset ensures all output buffers are in a disabled state when power is initially applied. A V_{DD} voltage comparator generates the power-on reset. When the voltage at V_{DD} is less than 2.5V, the power-on-reset comparator pulls $\overline{\text{RESET}}$ low through internal circuitry. As the digital supply voltage ramps up crossing 2.5V, the MAX4355 holds $\overline{\text{RESET}}$ low for 40ns (typ). Connecting a small capacitor from $\overline{\text{RESET}}$ to DGND extends the power-on-reset delay. See $\overline{\text{RESET}}$ Delay vs. $\overline{\text{RESET}}$ Capacitance in the *Typical Operating Characteristics*.

Thermal Shutdown

The MAX4355 features thermal shutdown protection with temperature hysteresis. When the die temperature exceeds +150°C, the MAX4355 pulls $\overline{\text{RESET}}$ low, disabling the output buffers. When the die cools by 20°C, the $\overline{\text{RESET}}$ pulldown is deasserted, and output buffers remain disabled until the device is programmed again.

Applications Information

Building Large Video-Switching Systems

The MAX4355 can be easily used to create larger switching matrices. The number of ICs required to implement the matrix is a function of the number of input channels, the number of outputs required, and whether the array needs to be nonblocking. The most straightforward technique for implementing nonblocking matrices is to arrange the building blocks in a grid. The inputs connect to each vertical bank of devices in parallel with the other banks. The outputs of each building block in a vertical column connect together in a wired-OR configuration. Figure 6 shows a 128-input, 32-output, nonblocking array using the MAX4355 16 x 16 crosspoint devices.

The wired-OR connection of the outputs shown in the diagram is possible because the outputs of the IC devices can be placed in a disabled or high-imped-

ance output state. This disable state of the output buffers is designed for a maximum impedance vs. frequency while maintaining a low-output capacitance. These characteristics minimize the adverse loading effects from the disabled outputs. Larger arrays are constructed by extending this connection technique to more devices.

Driving a Capacitive Load

Figure 6 shows an implementation requiring many outputs to be wired together. This creates a situation where each output buffer sees not only the normal load impedance, but also the disabled impedance of all the other outputs. This impedance has a resistive and a capacitive component. The resistive components reduce the total effective load for the driving output. Total capacitance is the sum of the capacitance of all the disabled outputs and is a function of the size of the matrix. Also, as the size of the matrix increases, the length of the PC board traces increases, adding more capacitance. The output buffers have been designed to drive more than 30pF of capacitance while still maintaining a good AC response. Depending on the size of the array, the capacitance seen by the output can exceed this amount. There are several ways to improve the situation. The first is to use more building-block crosspoint devices to reduce the number of outputs that need to be wired together (Figure 7).

In Figure 7, the additional devices are placed in a second bank to multiplex the signals. This reduces the number of wired-OR connections. Another solution is to put a small resistor in series with the output before the capacitive load to limit excessive ringing and oscillations. Figure 8 shows the graph of the Optimal Isolation Resistor vs. Capacitive Load. A lowpass filter is created from the series resistor and parasitic capacitance to ground. A single R-C does not affect the performance at video frequencies, but in a very large system there may be many R-Cs cascaded in series. The cumulative effect is a slight rolling off of the high frequencies causing a "softening" of the picture. There are two solutions to achieve higher performance. One way is to design the PC board traces associated with the outputs such that they exhibit some inductance. By routing the traces in a repeating "S" configuration, the traces that are nearest each other exhibit a mutual inductance increasing the total inductance. This series inductance causes the amplitude response to increase or peak at higher frequencies, offsetting the rolloff from the parasitic capacitance. Another solution is to add a small-value inductor to the output.

16 x 16 Nonblocking Video Crosspoint Switch with I/O Buffers

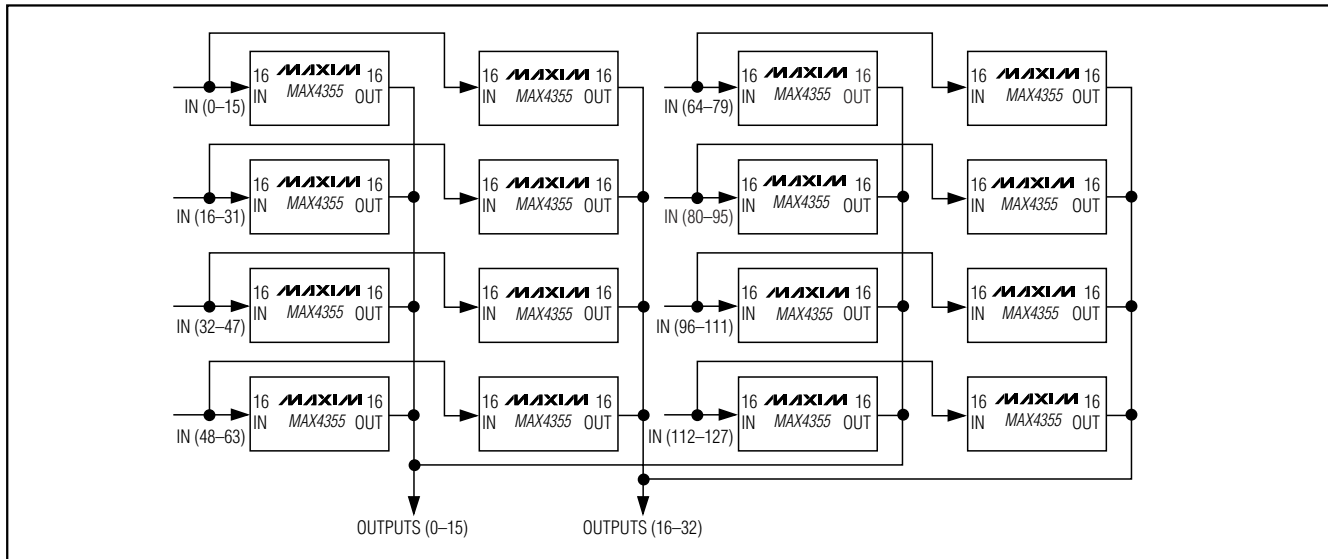

Figure 6. 128 x 32 Nonblocking Matrix Using 16 x 16 Crosspoint Devices

Crosstalk Signal and Board Routing Issues

Improper signal routing causes performance problems such as crosstalk. The MAX4355 has a typical crosstalk rejection of -62dB at 6MHz. A bad PC board layout degrades the crosstalk rejection by 20dB or more. To achieve the best crosstalk performance:

- 1) **Place ground isolation between long critical signal PC board trace runs.** These traces act as a shield to potential interfering signals. Crosstalk can be degraded by parallel traces as well as directly above and below on adjoining PC board layers.
- 2) **Maintain controlled-impedance traces.** Design as many of the PC board traces as possible to be 75Ω transmission lines. This lowers the impedance of the traces, reducing a potential source of crosstalk. More power is dissipated due to the output buffer driving a lower impedance.
- 3) **Minimize ground-current interaction by using a good ground plane strategy.**

In addition to crosstalk, another key issue of concern is isolation. Isolation is the rejection of undesirable feed-through from input to output with the output disabled. The MAX4355 achieves a -110dB isolation at 6MHz by selecting the pinout configuration such that the inputs and outputs are on opposite sides of the package. Coupling through the power supply is a function of the quality and location of the supply bypassing. Use appropriate low-impedance components and locate them as close as possible to the IC. Avoid routing the inputs near the outputs.

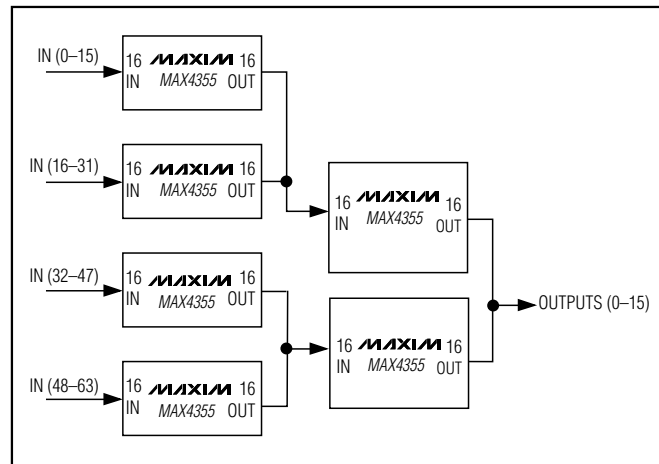

Figure 7. 64 x 16 Nonblocking Matrix with Reduced Capacitive Loading

Power-Supply Bypassing

The MAX4355 operates from a single +5V or dual $\pm 5V$ to $\pm 3V$ supplies. For single-supply operation, connect all VEE pins to ground and bypass all power-supply pins with a 0.1μF capacitor to ground. For dual-supply systems, bypass all supply pins to ground with 0.1μF capacitors.

Power in Large Systems

The MAX4355 has been designed to operate with split supplies down to $\pm 3V$ or a single supply of +5V. Operating at the minimum supply voltages reduces the

16 x 16 Nonblocking Video Crosspoint Switch with I/O Buffers

MAX4355

power dissipation by as much 40% to 50%. At +5V, the MAX4355 consumes 195mW (0.76mW/point).

Driving a PC Board Interconnect or a Cable ($A_v = +1V/V$ or $+2V/V$)

The MAX4355 output buffers can be programmed to either $A_v = +1V/V$ or $+2V/V$. The $+1V/V$ configuration is typically used when driving a short-length (less than 3cm), high-impedance "local" PC board trace. To drive a cable or a 75Ω transmission line trace, program the gain of the output buffer to $+2V/V$ and place a 75Ω resistor in series with the output. The series termination resistor and the 75Ω load impedance act as a voltage-divider that divides the video signal in half. Set the gain to $+2V/V$ to transmit a standard 1V video signal down a cable. The series 75Ω resistor is called the back-match, reverse termination, or series termination. This 75Ω resistor reduces reflections, and provides isolation, increasing the output-capacitive-driving capability.

Matrix Programming

The MAX4355's unique digital interface simplifies programming multiple MAX4355 devices in an array. Multiple devices are connected with DOUT of the first device connecting to DIN of the second device, and so on (Figure 9). Two distinct programming modes, individual output address mode (MODE = 0) and complete matrix mode (MODE = 1), are selected by toggling a single MODE control pin high or low. Both modes operate with the same physical board layout. This allows initial programming of the IC by daisy-chaining and sending one long data word while still being able to address immediately and update individual locations in the matrix.

Individual Output Address Mode (Mode 0)

In Individual Output Address Mode, the devices are connected in a serial bus configuration, with the data routing gate (Figure 3) connecting DIN to DOUT, making each device a virtual node on the serial bus. A single 16-bit control word is sent to all devices simultaneously. Only the device with the corresponding chip address responds to the programming word, and updates its output. In this mode, the chip address is set through hardware pin strapping of A3–A0. The host then communicates with the device by sending a 16-bit word consisting of 2 don't care MSB bits, 4 chip address bits, and 10 bits of data to make the word exactly 2 bytes in length. The 10 data bits are broken down into 4 bits to select the output to be programmed; 1 bit to set the output enable; 1 bit to set gain; and 4 bits to select the input to be connected to that output. In this method, the matrix is programmed one output at a time.

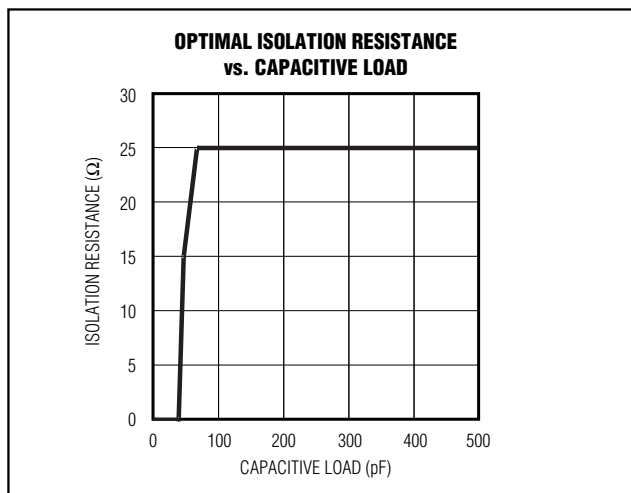

Figure 8. Optimal Isolation Resistor vs. Capacitive Load

Complete Matrix Mode (Mode 1)

In Complete Matrix Mode, the devices are connected in a daisy-chain fashion where $n \times 96$ bits are sent to program the entire matrix, and where n = the number of MAX4355 devices connected in series. This long data word is structured such that the first bit is the LSB of the last device in the chain and the last data bit is the MSB of the first device in the chain. The total length of the data word is equal to the number of crosspoint devices to be programmed in series times 96 bits per crosspoint device. This programming method is most often used at startup to initially configure the switching matrix.

+5V Single-Supply Operation with $A_v = +1V/V$ and $+2V/V$

The MAX4355 guarantees operation with single +5V supply and gain of $+1V/V$ for standard video input signals (1Vp-p). To implement a complete video matrix switching system capable of gain = $+2V/V$ while operating with +5V single supply, combine the MAX4355 crosspoint switch with Maxim's low-cost, high-performance video amplifiers optimized for single +5V supply operation (Figure 10). The MAX4450 single and MAX4451 dual op amps are unity-gain-stable devices that combine high-speed performance with Rail-to-Rail® outputs. The common-mode input voltage range extends beyond the negative power-supply rail (ground in single-supply applications). The MAX4450 is available in the ultra-small 5-pin SC70 package, while the MAX4451 is available in a space-saving 8-pin SOT23. The MAX4383 is a quad op amp available in a 14-pin

Rail-to-Rail is a registered trademark of Nippon Motorola, Ltd.

16x16 Nonblocking Video Crosspoint Switch with I/O Buffers

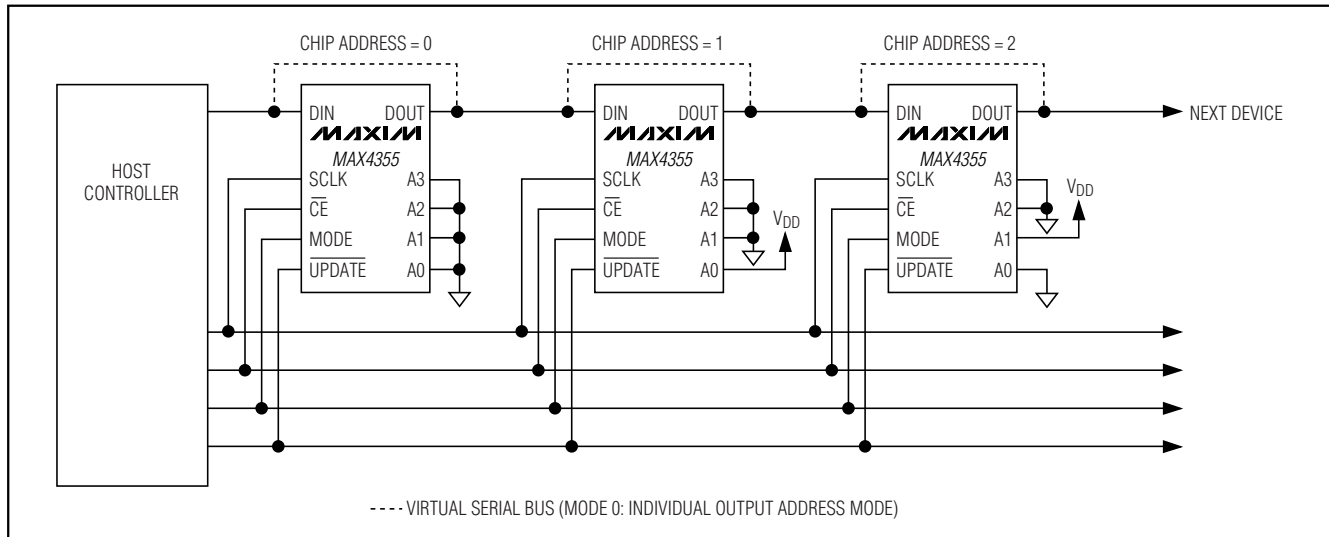

Figure 9. Matrix Mode Programming

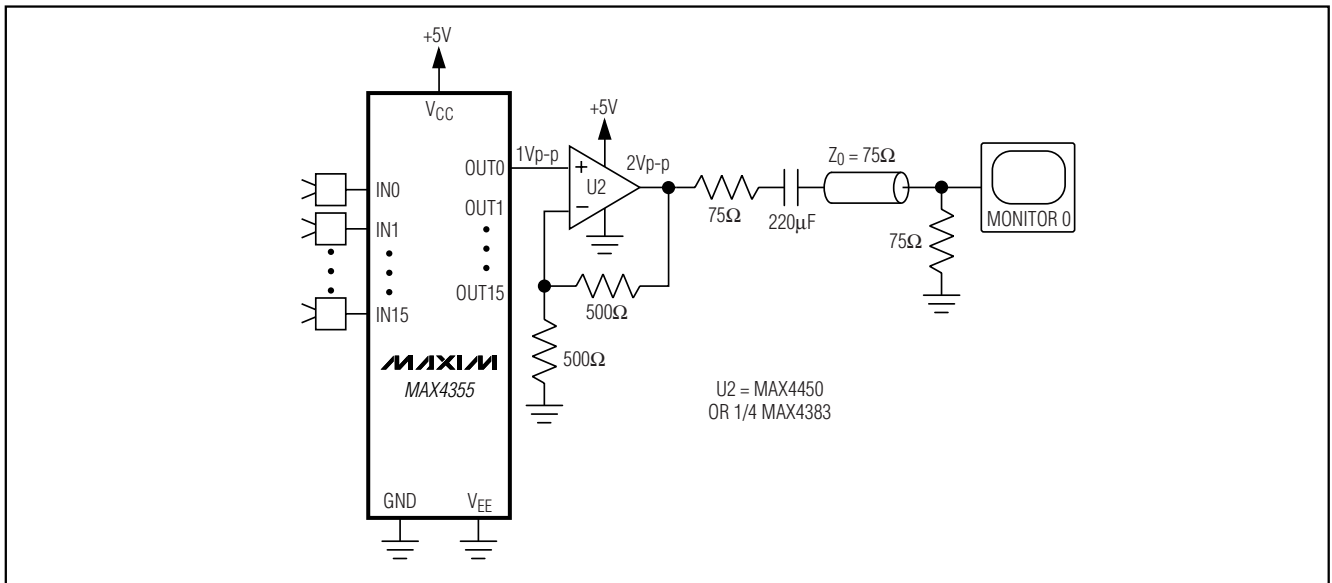

Figure 10. Typical Single +5V Supply Application

TSSOP package. The MAX4380/MAX4381/MAX4382 and MAX4384 offer individual high-impedance output disable making these amplifiers suitable for wired-OR connections.

Chip Information

TRANSISTOR COUNT: 24,467

PROCESS: BiCMOS

16 x 16 Nonblocking Video Crosspoint Switch with I/O Buffers

Pin Configuration

MAX4355

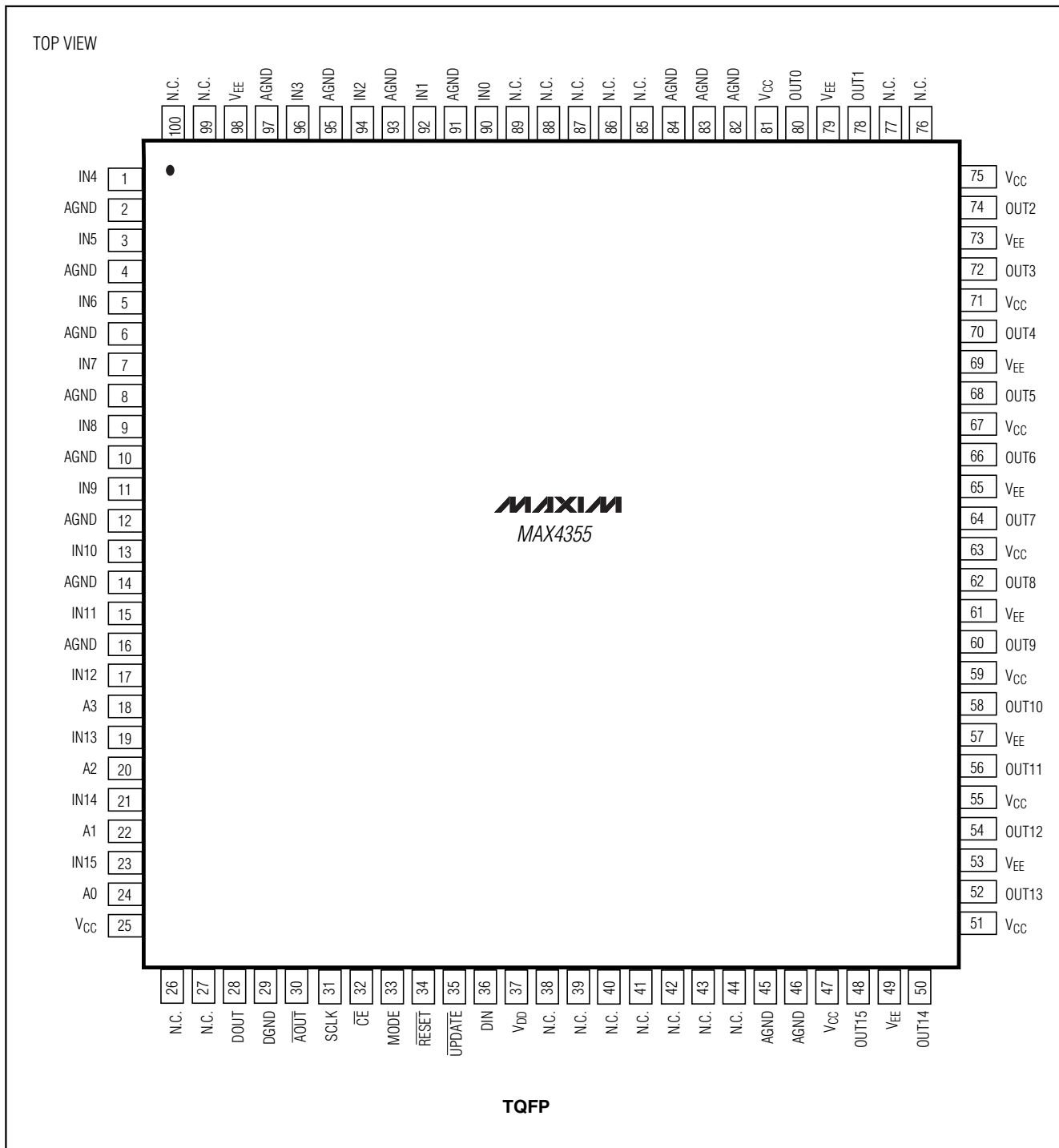

16x16 Nonblocking Video Crosspoint Switch with I/O Buffers

Package Information

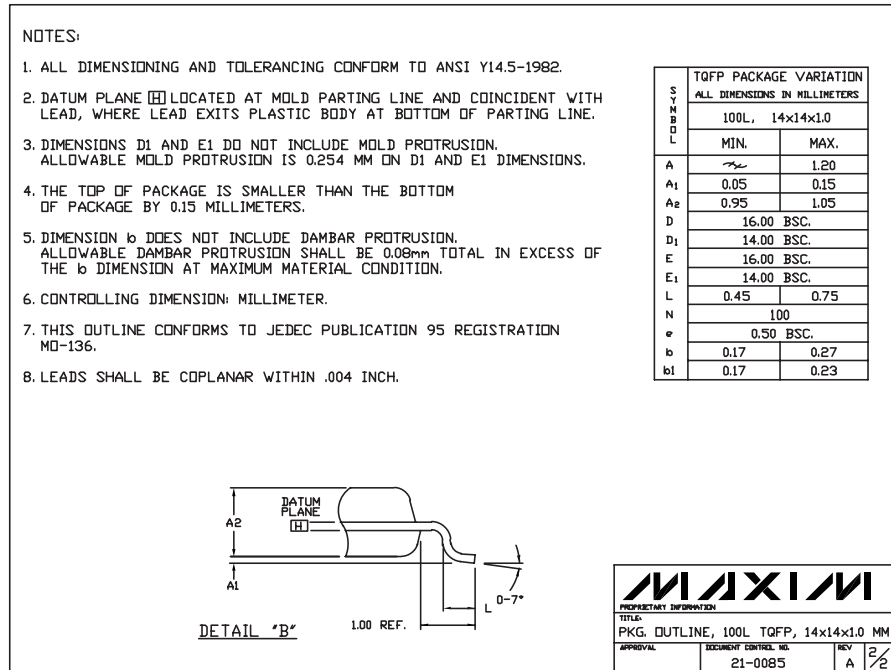
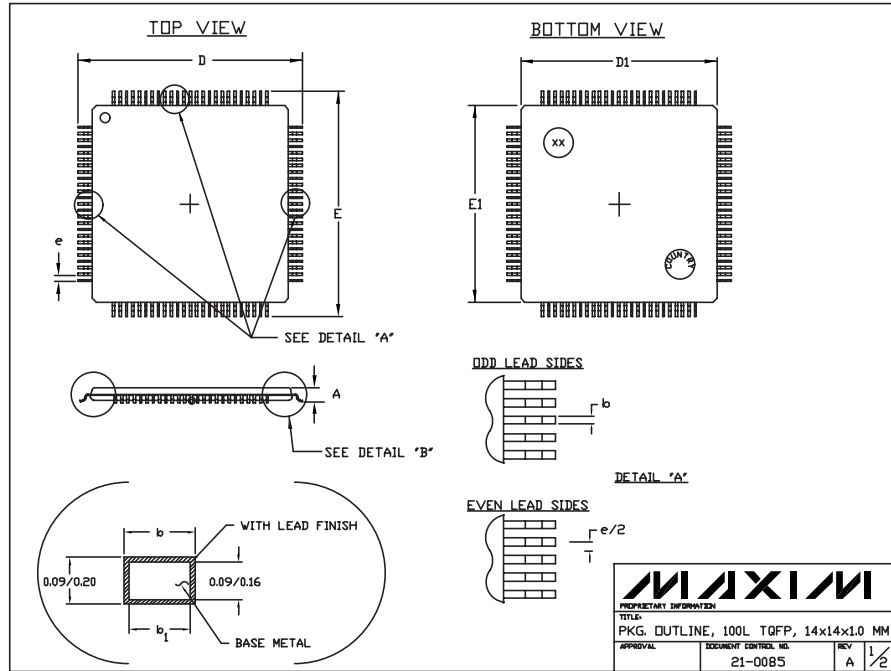

Maxim cannot assume responsibility for use of any circuitry other than circuitry entirely embodied in a Maxim product. No circuit patent licenses are implied. Maxim reserves the right to change the circuitry and specifications without notice at any time.

40 **Maxim Integrated Products, 120 San Gabriel Drive, Sunnyvale, CA 94086 408-737-7600**