

Description

The model ESX10-Sxxx extends our product group of electronic overcurrent protection devices for DC 24 V applications.

At a width of only 12.5mm it provides selective protection for all DC 24 V load circuits. This is achieved by a combination of active electronic current limitation in the event of a short circuit and overload disconnection typically from 1.2 times rated current. The ESX10-S is a plug-in type and thus allows quick and easy installation for groups of devices with several circuits on the power distribution systems Module 17plus and SVSxxx.

DC 24 V switch-mode power supplies are widely used in automation today. In the event of an overload, however, they turn down the output voltage which is intended to power all connected loads. So if there is a failure in a single load of the system, the supply voltage will break down also in all other load circuits. Not only does this frequently cause undefined fault conditions, but it can even lead to machine stoppages or system downtimes.

This is exactly where the ESX10-S comes in by responding to the overload conditions faster than the switch-mode power supply. The max. possible overcurrent is limited to typically 1.4 times rated current (see table 1). This allows switching on capacitive loads of up to 20,000 μ F, but a disconnection will only be effected in the event of an overload or short circuit. For adjustment to the load conditions the current rating can be selected by means of a rotary switch from 1A to 10A. Status and failure indication is by means of a multi-coloured LED, an integral short circuit proof status output (single or group alarms) or via a potential-free relay contact (change-over contact). Remote actuation is possible via a remote reset signal. The manual ON/OFF switch on the device itself allows start-up of certain individual load circuits. As soon as the ESX10-S detects overload or short circuit in its load circuit, it blocks the load output transistor and disconnects the current flow in the faulty circuit. After remedy of the failure, the load output of the ESX10-S is re-activated by an electronic reset signal or manually by actuating the ON/OFF switch on the device.

US patent number: US 6,490,141 B2

Features and Benefits

- Selective load protection, electronic trip curve
- All types of loads can be connected (DC 24 V motors upon request)
- Active current limitation when switching on capacitive loads up to min. 20,000 μ F and in case of overload/short circuit
- Whole-number adjustable current ratings from 1A to 10 A by means of rotary switch
- Reliable overload disconnection typically from 1.2 x I_N even with long load lines or small cable cross sections
- Manual ON/OFF switch (S1)
- Clear status indication by means of LED, electronic status output SF or signal output F (potential-free auxiliary contact)
- Electronic reset input RE, control input IN
- Integral fail-safe-element
- Width per channel only 12.5 mm
- Plug-in type mounting on power distribution system Module 17plus and SVSxxx.

Approvals

Authority	Standard	Rated voltage	Current ratings
UL	UL 2367	DC 24 V	1...10 A
UL	UL 508 C22.2 No 14	DC 24 V	1...10 A



Technical data ($T_{amb} = 25\text{ }^{\circ}\text{C}$, $U_B = \text{DC } 24\text{ V}$)

Operating data

Operating voltage U_B	DC 24 V (18...32 V)
Current ratings I_N	adjustable ratings: 1 A through 10 A in 1 A steps
Standby current I_0	in ON condition: typically 25 mA with version -103/-115/-125 typically 20 mA with version -114/-117/-124/-127
Visual status indication	multicoloured LED: green: - load circuit connected flashing (green/yellow): - load current warning limit reached 80% yellow: - overload or short circuit until disconnection red: - after disconnection due to overload, short circuit or temperature - after undervoltage disconnection in ON condition of operating voltage with automatic reset flashing (red/OFF): - upon changed rating adjustment OFF: - devices switched off via ON/OFF switch - no operating voltage with ON/OFF switch in ON condition

Load circuit

Load output	power MOSFET switching output (plus switching)
Load current	typically 0.8 x I_N
warning limit (I_{Limit})	typically 5%
hysteresis	typically 5%
Overload disconnection (I_{OL})	typically 1.2 x I_N (1.05...1.35 x I_N) (see time/current characteristic)
Short circuit current (I_{SC})	active current limitation with $I_{SC} =$ typically 2.5 x I_N , 1 A typically 1.4 x I_N , 2 A - 10 A (see time/current characteristic)
Trip times	at overload disconnection (I_{OL}) = typ. 3 s at short circuit current (I_{SC}) = typically 0.1 s (see time/current characteristic)
Temperature	internal temperature monitoring with monitoring electronic disconnection
disconnection hysteresis	typically +100 $^{\circ}\text{C}$ typically 10 $^{\circ}\text{C}$
Operating voltage monitoring with regard to low voltage	OFF at typically $U_B < 16.0\text{ V}$ ON at typically $U_B > 17.5\text{ V}$ with automatic ON and OFF switching

Technical data ($T_{amb} = 25\text{ °C}$, $U_B = DC\ 24\ V$)

Switch-on delay t_{Start}	typically 0.1 s - after each ON operation, reset and after applying of U_B - during switch-on delay the load circuit is disconnected.
Disconnection of load circuit	- manually on the device with the ON/OFF switch (OFF) - after disconnection due to overload or short circuit - temporarily at undervoltage - at excess temperature of the device - upon changed rating adjustment - at no operating voltage
Leakage current in load circuit in the OFF condition	typically < 1 mA
Capacitive loads	min. 20,000 μF
Free-wheeling diode	external free-wheeling diode recommended for inductive load
Parallel connection of several load outputs	not allowed
Status output SF	ESX10-S114 / -S124
Electrical data	plus switching signal output, connects U_B to terminal SF Rated data: DC 24 V / max. 0.2 A (short circuit proof) The status output is connected internally with a 10 kOhm resistor against 0 V
Status OUT (-S114/-S124)	ESX10-S114/-S124 (Signal Status OUT), at $U_B = +24\ V$
Normal condition:	+ 24 V S1 is ON, load output connected
Fault condition:	0 V S1 is ON, load output blocked or in the event of manual disconnection (S1 is OFF) red LED lighted
	0 V no operating voltage U_B
Status output \overline{SF}	ESX10-S117/-S127
Electrical data	plus switching signal output, connects U_B to terminal \overline{SF} Rated data: DC 24 V / max. 0.2 A (short circuit proof) The status output is locked internally with a 10 kOhm resistor against 0 V.
Status \overline{OUT} (-S117/-S127)	ESX10-S117/-S127 (Signal Status OUT inverted), at $U_B = +24\ V$
Standard condition:	0 V ON/OFF switch is ON, load output connected through
Fault condition:	+ 24 V ON/OFF switch is ON, load output locked or with manual disconnection ON/OFF switch is OFF
	0 V no operating voltage U_B
Control input IN+	ESX10-S114 / -S115 / -S117
Electrical data	voltage max. DC 32 V High > DC 8 V < DC 32 V Low < DC 3 V > 0 V Current consumption typically 2.6 mA (DC 24 V)
Control input IN+	+24 V level (HIGH): device is switched on by a remote ON/OFF signal. 0 V level (LOW) device is switched off by a remote ON/OFF signal.
Switch S1 ON/OFF	device can only be switched on when a HIGH level is applied to IN+
Reset function	a blocked load output (blocked by overload/short circuit) can externally be reset by the control input For this purpose the control input has to be switched off for at least 100 ms and switched on again afterwards.

Technical data ($T_{amb} = 25\text{ °C}$, $U_B = DC\ 24\ V$)

Reset input RE	ESX10-124/-125/-S127
Electrical data	voltage max. + DC 32 V high > DC 8 V \leq DC 32 V low \leq DC 3 V > 0 V current consumption typically 2.6 mA (+ DC 24 V) RESET – pulse / edge from low > 100 ms on high > 100 ms
Reset signal RE	By means of the reset signal the electronically locked ESX10-S124/-S125/-S127 can be remotely reset via an external momentary switch or via the PLC. A joint reset signal can also be applied to more than one device at a time. Devices in ON condition will remain unaffected.
Signal output F	ESX10-S103
Electrical data	potential-free auxiliary change-over contact max. DC 30 V / 0.5 A min. 10 V / 10 mA
Standard condition:	SC/SO (13/14) closed SC-SI (13/12) open load output connected through
Fault condition:	SC/SO (13/14) open SC-SI (13/12) closed load output locked
Signal output F	ESX10-S115 / -S125
Electrical data	potential-free auxiliary make contact max. DC 30 V / 0.5 A min. 10 V / 10 mA
Normal condition:	SC/SO (13/14) closed load output connected
Fault condition:	SC/SO (13/14) open load output locked
General Characteristics	
Fail-safe-element	integral fail-safe-element 15 A Max. rupture capacity of the element is 300 A at 24 V DC
Terminals	LINE+ / LOAD+ / 0V / (RE / IN+ / SF) or (SC / SO / SI)
Blade terminals	6.3 mm to EN60934-6.3-0.8
Housing material	moulded
Mounting method	plug-in type onto Module 17plus and SVSxx
Ambient temperature	0...+50 °C (without condensation, cf. EN 60204-1)
Storage temperature	-40...+70 °C
Humidity	96 hrs / 95% RH 40°C to IEC 60068-2-78-Cab climate class 3K3 to EN 60721
Vibration	3g test to IEC 60068-2-6, test Fc ,
Degree of protection	IEC 60529, DIN VDE 0470) operating area IP30 terminal area IP00
EMC requirements (EMC directive, CE logo)	emission: EN 61000-6-3 susceptibility: EN 61000-6-2
Insulation co-ordination (IEC 60934)	0.5 kV / pollution degree 2 reinforced insulation in operating area
Dielectric strength	max. DC 30 V (load circuit)
Insulation resistance (OFF condition)	n/a, only electronic disconnection
Approvals	CE logo UL 2367, File # E306740, Solid State Overcurrent Protectors UL 508, File # E322549
Dimensions (w x h x d)	12.5 x 70 x 60 mm (tolerances to DIN ISO 286 part 1 IT13)
Mass	approx. 40 g

Table 1: typical voltage drop, current limitation, max. load current

Current rating I_N	Typical voltage drop U_{ON} at I_N	active current limitation I_{Limit} typically	Max. load current at 100 % ON duty	
			$T_{AMB} = 40\text{ °C}$	$T_{AMB} = 50\text{ °C}$
1 A	15 mV	$2,5 \times I_N$	1 A	1 A
2 A	30 mV	$1,4 \times I_N$	2 A	2 A
3 A	45 mV	$1,4 \times I_N$	3 A	3 A
4 A	60 mV	$1,4 \times I_N$	4 A	4 A
5 A	75 mV	$1,4 \times I_N$	5 A	5 A
6 A	90 mV	$1,4 \times I_N$	6 A	5 A
7 A	105 mV	$1,4 \times I_N$	7 A	6 A
8 A	120 mV	$1,4 \times I_N$	8 A	7 A
9 A	135 mV	$1,4 \times I_N$	9 A	8 A
10 A	150 mV	$1,4 \times I_N$	10 A	9 A

Note: When mounted side-by-side without convection, the devices should carry max 80% of their rated load continuously (100 % ON duty).

Time/current characteristic curve ($T_{amb} = 25\text{ °C}$, $U_B = DC\ 24\ V$)

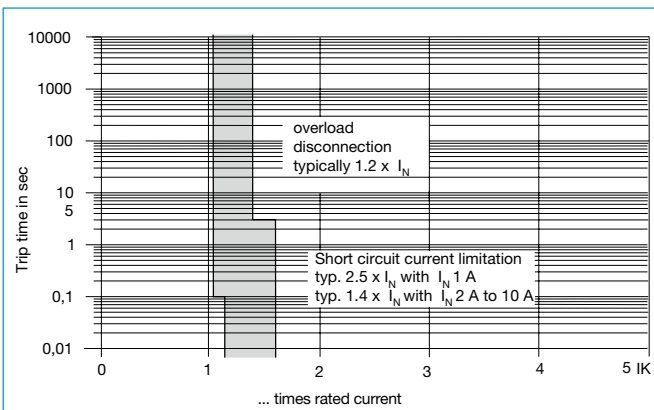

- Without the current limitation there would be a much higher overcurrent in the event of an overload or short circuit.

Schematic diagram ESX10-S127 (example)

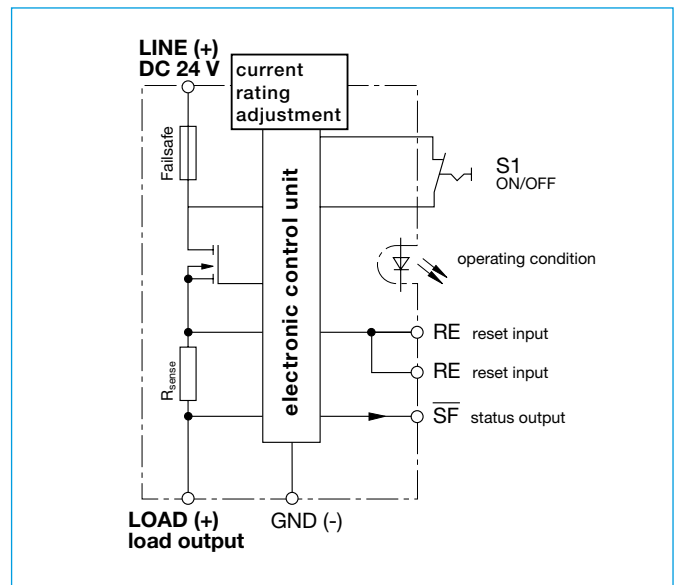

Order numbering code

Type No.
ESX10 Electronic Circuit Protector, with current limitation
Mounting
S plug-in, with rotary switch for 10-step current rating adjustment from 1 A to 10 A
Version
1 without physical isolation
Signal input
0 without signal input (only version -S103)
1 control input I_N (only version -S114/-S115/-S117)
2 with reset input RE (only version -S124/-125/-127)
Signal output:
3 signal change-over contact (only version -S103)
4 status output SF (only version -S114/-124)
5 signal contact (only version -S115/-125)
7 status output SF, inverted (only version -S/117/-S127)
Operating voltage
DC 24 V voltage rating DC 24 V
Current ratings
1 A - 10 A adjustable

ESX10 - S 1 0 3 - DC 24 V - 1 A - 10 A ordering example

Standard types:
ESX10-S103-DC24V-1A...10A
ESX10-S127-DC24V-1A...10A

Please note

- The user has to ensure that the cable cross section of the load circuit in question complies with the current rating of the ESX10-S used.
- In addition special precautions must be taken in the system or machine (e.g. use of a safety PLC) which reliably prevent an automatic re-start of parts of the system (cf. Machinery Directive 2006/42/EG and EN 60204-1, Safety of Machinery). In the event of a failure (short circuit/overload) the load circuit will be disconnected electronically by the ESX10-S.

Wiring diagrams

The auxiliary contacts are shown in the OFF or fault condition

ESX10-S103
without signal input
with signal output F (group signal, change-over)

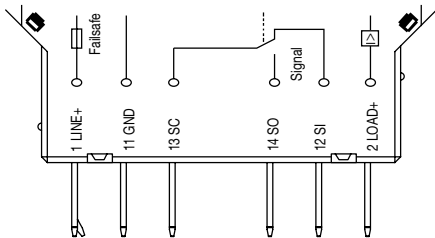

Standard condition: SC/SO closed, SC-SI open
Fault condition: SC/SO open, SC-SI closed

ESX10-S114
with signal input IN+
with status indication SF

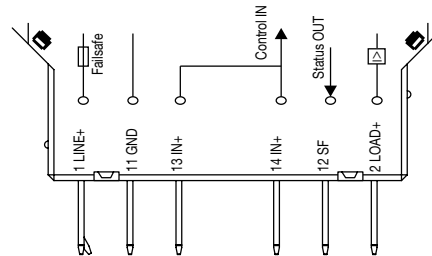

Standard condition: SF+24V = OK
Fault condition: SF 0V

ESX10-S115
with signal input IN+
with signal output F (group signal, N/O)

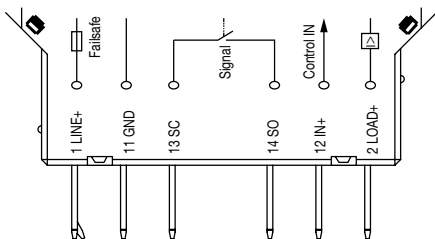

Standard condition: SC/SO closed
Fault condition: SC/SO open

ESX10-S117
with signal input IN+
with status indication SF inverted

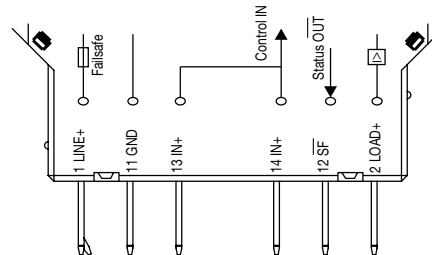

Standard condition: SF 0V = OK
Fault condition: SF +24V

ESX10-S124
with reset input RE
with status indication SF

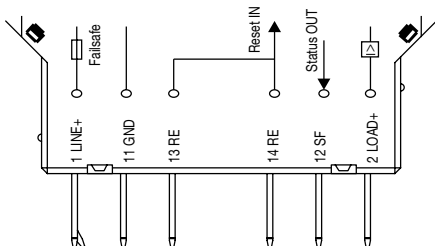

Standard condition: SF +24V = OK
Fault condition: SF 0V

ESX10-S125
with reset input RE
with signal output F (group signal, N/O)

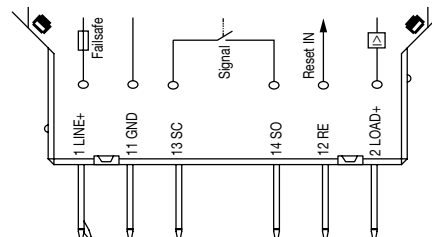

Standard condition: SC/SO closed
Fault condition: SC/SO open

ESX10-S127
with reset input RE
with status indication SF inverted

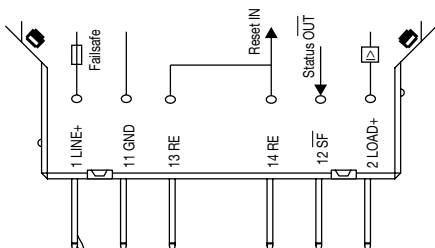

Standard condition: SF 0 V = OK
Fault condition: SF +24 V

4

Dimensions ESX10-S

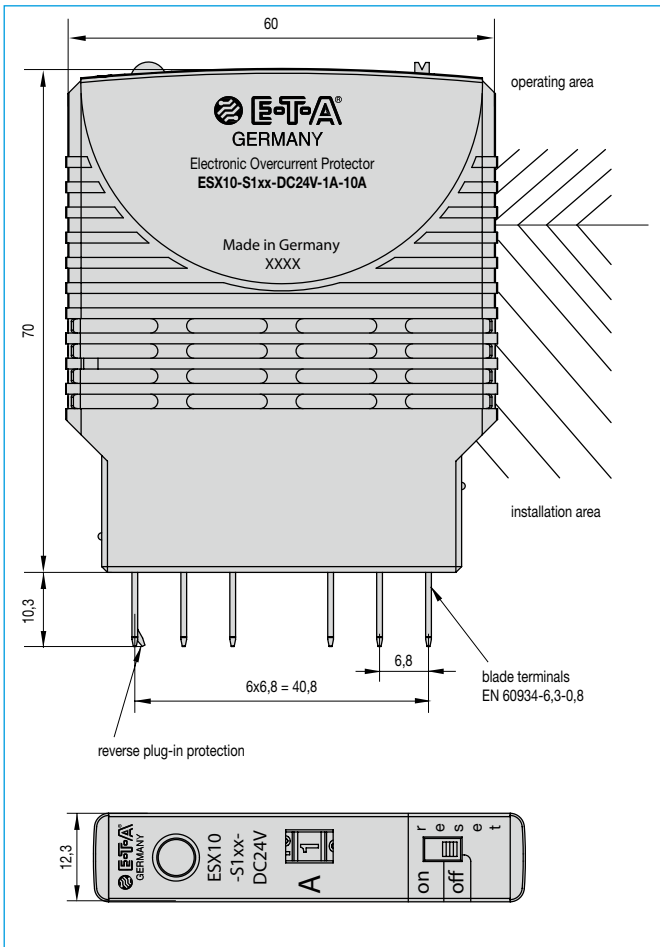

Accessories

Module 17plus
For technical data see section Power Distribution Systems

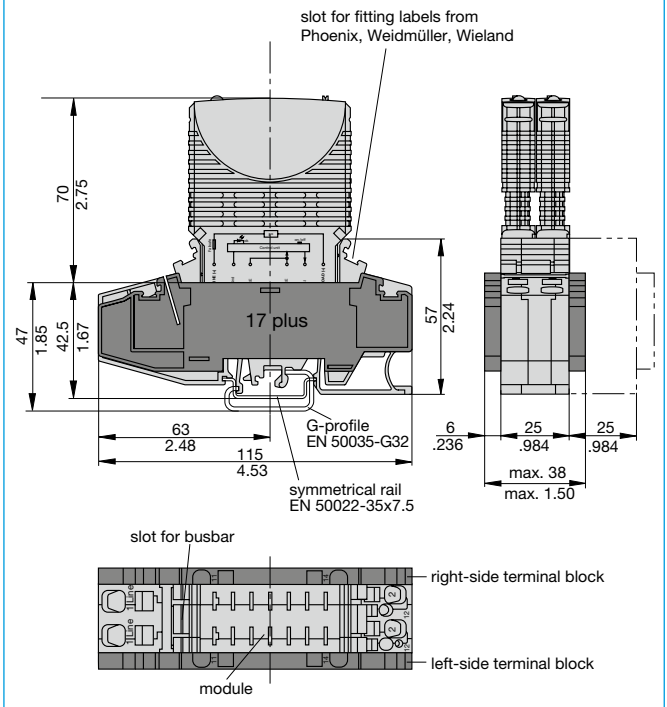

All dimensions without tolerances are for reference only. In the interest of improved design, performance and cost effectiveness, the right to make changes in these specifications without notice is reserved. Product markings may not be exactly as the ordering codes. Errors and omissions excepted.

