

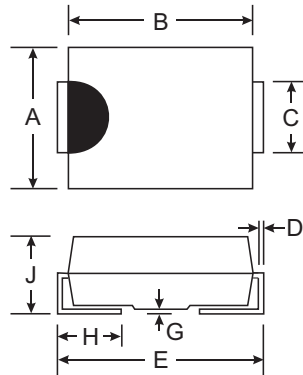

Features

- Guard Ring Die Construction for Transient Protection
- Ideally Suited for Automatic Assembly
- Low Power Loss, High Efficiency
- Surge Overload Rating to 30A Peak
- For Use in Low Voltage, High Frequency Inverters, Free Wheeling, and Polarity Protection Application
- Lead Free Finish/RoHS Compliant (Note 3)**



| Dim | SMA | | SMB | |
|-----------------------------|------|------|------|------|
| | Min | Max | Min | Max |
| A | 2.29 | 2.92 | 3.30 | 3.94 |
| B | 4.00 | 4.60 | 4.06 | 4.57 |
| C | 1.27 | 1.63 | 1.96 | 2.21 |
| D | 0.15 | 0.31 | 0.15 | 0.31 |
| E | 4.80 | 5.59 | 5.00 | 5.59 |
| G | 0.10 | 0.20 | 0.10 | 0.20 |
| H | 0.76 | 1.52 | 0.76 | 1.52 |
| J | 2.01 | 2.62 | 2.00 | 2.62 |
| All Dimensions in mm | | | | |

Mechanical Data

- Case: SMA/SMB
- Case Material: Molded Plastic. UL Flammability Classification Rating 94V-0
- Moisture Sensitivity: Level 1 per J-STD-020C
- Terminals: Lead Free Plating (Matte Tin Finish). Solderable per MIL-STD-202, Method 208 
- Polarity: Cathode Band or Cathode Notch
- Marking Information: See page 3
- Ordering Information: See page 3
- Approximate Weight: SMA 0.064 grams
SMB 0.093 grams

No Suffix Designates SMA Package
"B" Suffix Designates SMB Package

Maximum Ratings and Electrical Characteristics @ T_A = 25°C unless otherwise specified

Single phase, half wave, 60Hz, resistive or inductive load.
For capacitive load, derate current by 20%.

| Characteristic | Symbol | B120/B | B130/B | B140/B | B150/B | B160/B | Unit |
|---|-----------------------------------|-------------|--------|--------|-----------|--------|------|
| Peak Repetitive Reverse Voltage | V _{RRM} | 20 | 30 | 40 | 50 | 60 | V |
| Working Peak Reverse Voltage | V _{RWM} | | | | | | |
| DC Blocking Voltage | V _R | | | | | | |
| RMS Reverse Voltage | V _{R(RMS)} | 14 | 21 | 28 | 35 | 42 | V |
| Average Rectified Output Current @ T _T = 130°C | I _O | 1.0 | | | | | A |
| Non-Repetitive Peak Forward Surge Current 8.3ms single half sine-wave superimposed on rated load | I _{FSM} | 30 | | | | | A |
| Forward Voltage @ I _F = 1.0A | V _{FM} | 0.50 | | | 0.70 | | V |
| Peak Reverse Current @ T _A = 25°C at Rated DC Blocking Voltage @ T _A = 100°C | I _{RM} | | | | 0.5 10 | | mA |
| Typical Total Capacitance (Note 2) | C _T | 110 | | | | | pF |
| Typical Thermal Resistance Junction to Terminal (Note 1) | R _{JT} | 20 | | | | | °C/W |
| Operating and Storage Temperature Range | T _J , T _{STG} | -65 to +150 | | | | | °C |

- Notes:
1. Thermal Resistance: Junction to terminal, unit mounted on PC board with 5.0 mm² (0.013 mm thick) copper pads as heat sink.
 2. Measured at 1.0 MHz and applied reverse voltage of 4.0V DC.
 3. RoHS revision 13.2.2003. High Temperature Solder Exemption Applied, see EU Directive Annex Note 7.

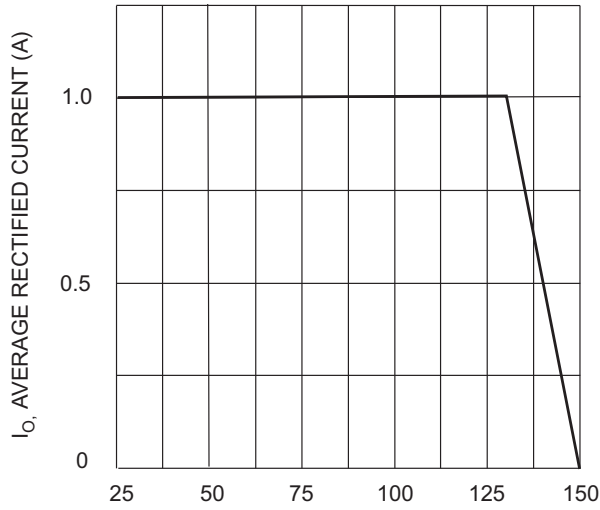

T_T , TERMINAL TEMPERATURE ($^{\circ}C$)
Fig. 1 Forward Current Derating Curve

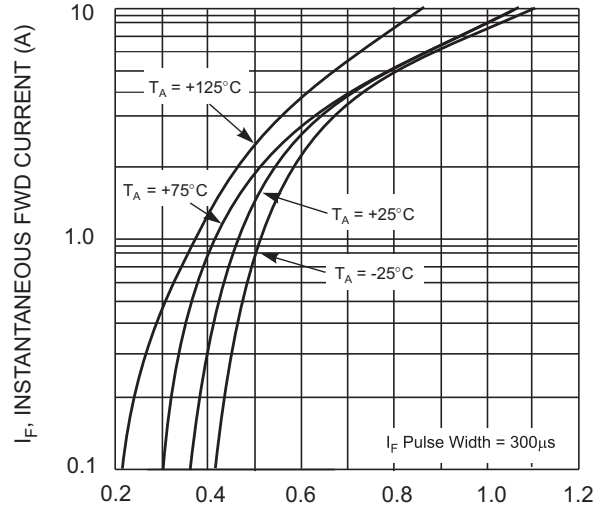

V_F , INSTANTANEOUS FORWARD VOLTAGE (V)
Fig. 2 Typical Forward Characteristics - B120/B thru B140/B

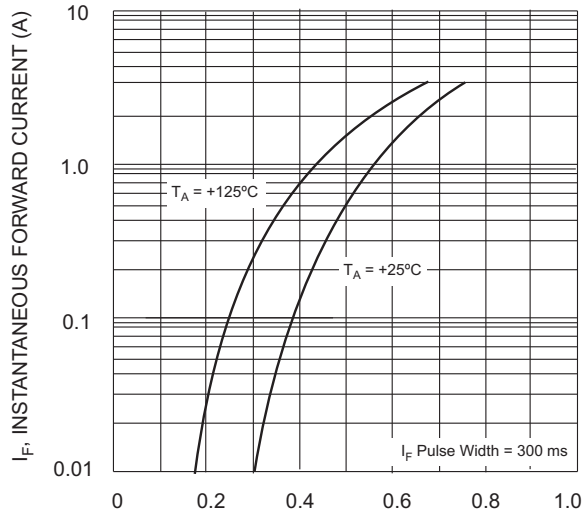

V_F , INSTANTANEOUS FWD VOLTAGE (V)
Fig. 3 Typ. Forward Characteristics - B150/B thru B160/B

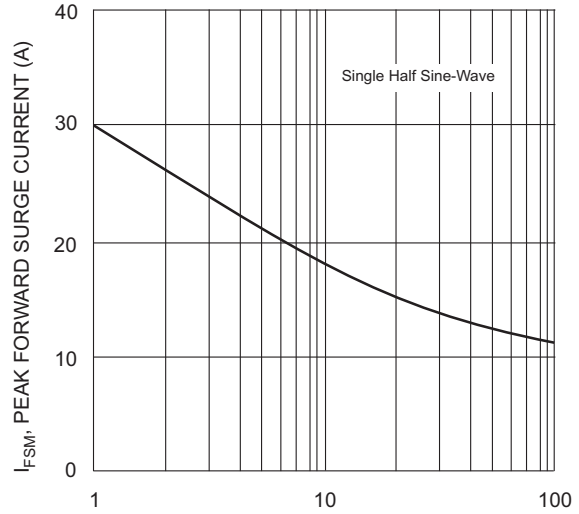
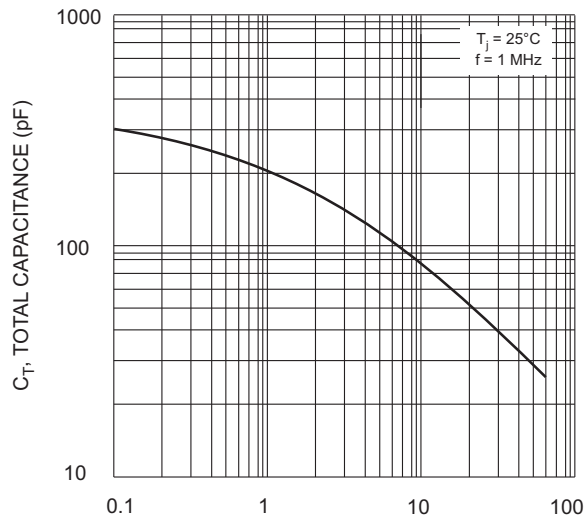
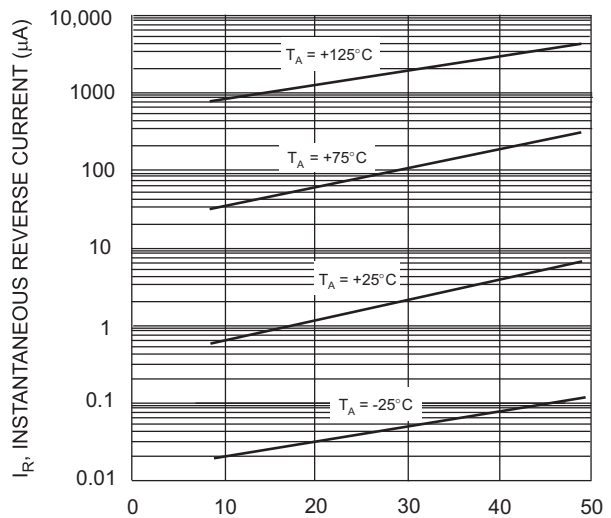

Fig. 4 Max Non-Repetitive Peak Fwd Surge Current



V_R , REVERSE VOLTAGE (V)
Fig. 5 Typical Total Capacitance



V_R , INSTANTANEOUS REVERSE VOLTAGE (V)
Fig. 6 Typical Reverse Characteristics, B120/B thru B140/B

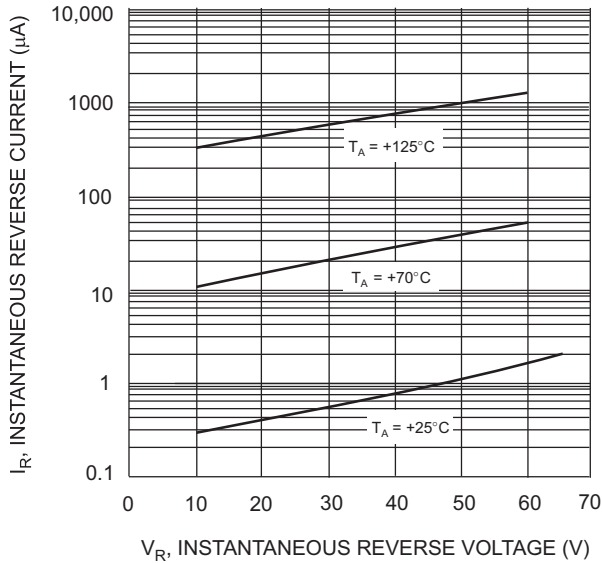

Ordering Information (Note 4)

| Device* | Packaging | Shipping |
|------------|-----------|------------------|
| B1XX-13-F | SMA | 5000/Tape & Reel |
| B1XXB-13-F | SMB | 3000/Tape & Reel |

Notes: 4. For Packaging Details, go to our website at <http://www.diodes.com/datasheets/ap02007.pdf>.

* xx = Device type, e.g. B120-13-F (SMA package); B120B-13-F (SMB package).

Marking Information

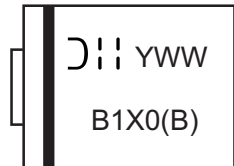

B1X0 = Product type marking code, ex: B120 (SMA package)
 B1X0B = Product type marking code, ex: B160B (SMB package)
 ⌋!⌋ = Manufacturers' code marking
 YWW = Date code marking
 Y = Last digit of year ex: 2 for 2002
 WW = Week code 01 to 52

Note: Device has a cathode band (as shown above) and may also have a cathode notch (as shown on Page 1).

IMPORTANT NOTICE

Diodes Incorporated and its subsidiaries reserve the right to make modifications, enhancements, improvements, corrections or other changes without further notice to any product herein. Diodes Incorporated does not assume any liability arising out of the application or use of any product described herein; neither does it convey any license under its patent rights, nor the rights of others. The user of products in such applications shall assume all risks of such use and will agree to hold Diodes Incorporated and all the companies whose products are represented on our website, harmless against all damages.

LIFE SUPPORT

Diodes Incorporated products are not authorized for use as critical components in life support devices or systems without the expressed written approval of the President of Diodes Incorporated.