

FAST ACTING PROTECTORS

C-FAP

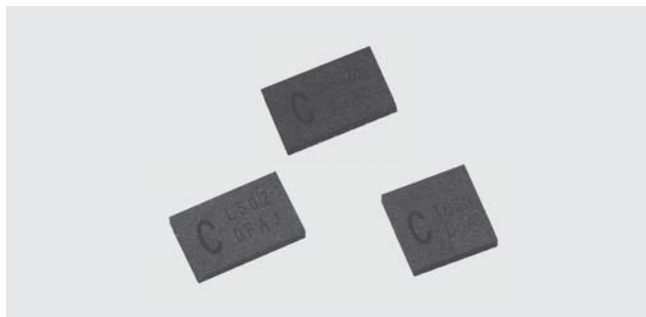

C-FAP series are resettable overcurrent protection device with high speed response. Protecting electronic equipment against transient voltage caused by short circuits, AC power cross, induction and lightning surge.

FEATURES

- Integrated MOSFET and Current detection circuit
- 1 or 2 circuit per package
- Uni- or Bi-directional trigger current
- Fixed or Variable trigger current
- Protection against lightning surge (With use of overvoltage component GDT)
- Fast response (less than 1 μ sec)
- Wide bandwidth (fc = 3 GHz)
- Small energy consumption (100 nJ)
- Small SMD Package(DFN)
- Agency recognition: UL
- RoHS Compliant

APPLICATIONS

- Industrial
Communication port (RS-232,422,485), LVDS, CANBUS, Microwave links, Process control system, Smart Grid Communication equipments, Ethernet, Elevator / Escalator, Conveyor equipments, Automated Test Equipments (ATE), Measurement / Test equipment, Railway communication system, Security camera and etc.
- Telecommunication
Voice / VDSL card, Cable modem, ONT, Gateway, MDU, T1 / E1 and wireless communication equipment.

PART NUMBER DESIGNATION

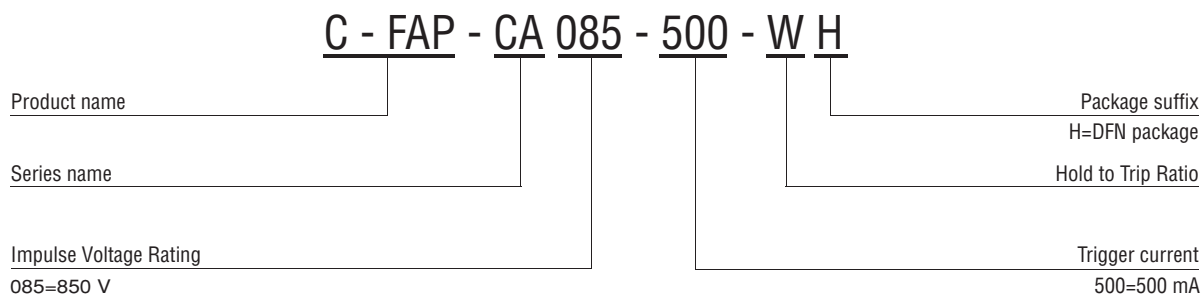

C-FAP

FAST ACTING PROTECTORS

BASIC METHOD FOR OVER CURRENT PROTECTION

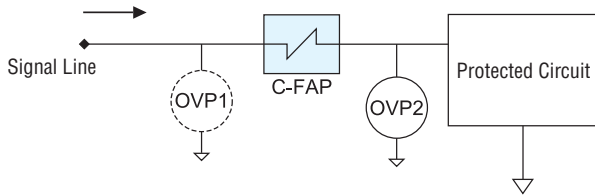

- **OVP1:** Overvoltage protection device to protect C-FAP against lightning surge, using GDT (Gas Discharge Tube) or MDV (Metal Oxide Varista)
- **C-FAP:** will limit current into Protected Circuit
- **OVP2:** Zener Diode to protect Protected Circuit from over voltage.

SELECTION GUIDE FOR C-FAP, GDT, MOV

Selection of C-FAP

- Choose the C-FAP with the impulse voltage (V_{imp}) higher than the surge voltage of the signal line.
- Choose the C-FAP with trigger current correspond to the maximum current of the protected circuit.

Selection of GDT, MOV

- Please refer to the recommended devices of each application.

EXAMPLE OF APPLICATION

VDSL

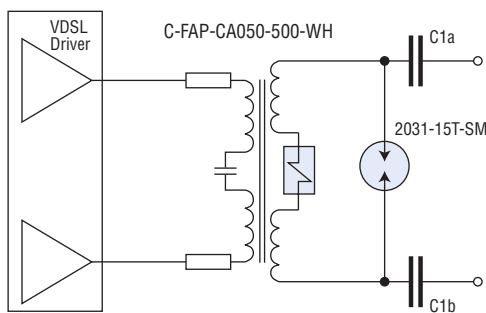

Giga Bit Ethernet

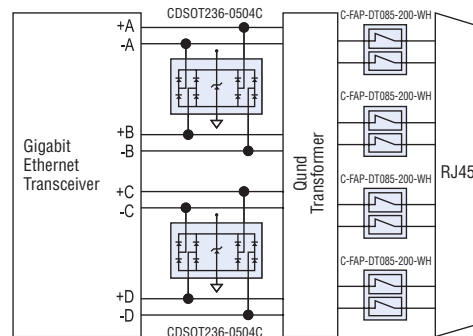

RS232Interface

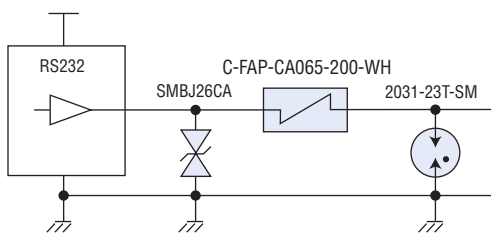

RS485 Interface

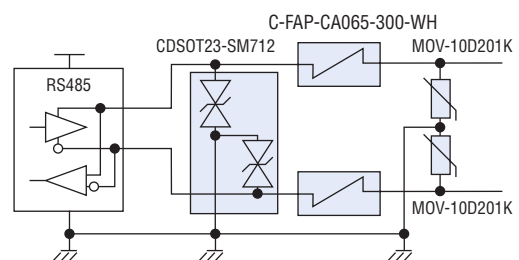

C-FAP

FAST ACTING PROTECTORS

TRIGGER CURRENT OF C-FAP SERIES

Please note when selecting the correct product that there is direction of the trigger current in C-FAP series.

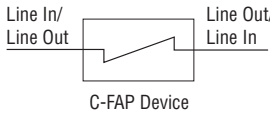
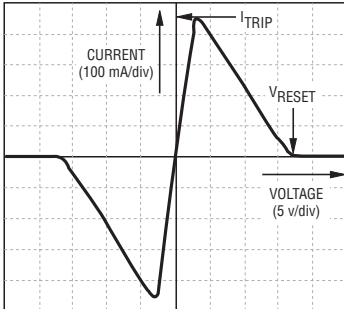
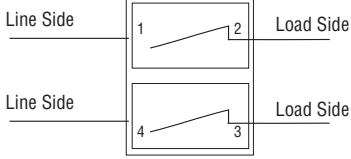
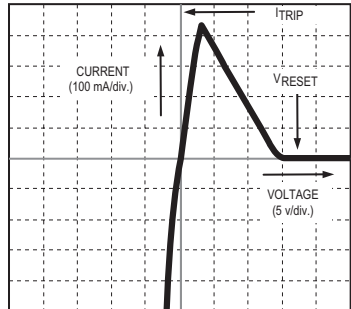
Direction of trigger current	Bi-directional	Uni-directional
Product series name	C-FAP-CA, PL	C-FAP-DT
Circuit Symbol & Operating Waveform	 <p>C-FAP Device</p> <p>(C-FAP-CA050-300-WH)</p> 	 <p>(C-FAP-DT085-300-WH) (Pin2-1&Pin3-4)</p> 

LIST OF PART NUMBERS & SPECIFICATIONS

Type of Bi-directional trigger current with 2 circuit

- C-FAP-PL Series : Application for Telecommunication (SLIC Protection)

Part Number	Absolute Max. Ratings		Electrical Characteristic			Outer Dimensions (mm)	Overview
	Vimp(V)	Vrms(V)	Itrigger Min.(mA)	Itrigger Max.(mA)	RC-FAP (Ω)		
C-FAP-PL050-100-WH	500	300	100	200	50	6.5 x 4.00	
C-FAP-PL050-200-WH	500	300	200	400	50		
C-FAP-PL060-100-WH	600	350	100	200	50		
C-FAP-PL060-200-WH	600	350	200	400	50		
C-FAP-PL075-100-WH	750	400	100	200	50		
C-FAP-PL075-200-WH	750	400	200	400	50		
C-FAP-PL085-100-WH	850	425	100	200	50		
C-FAP-PL085-200-WH	850	425	200	400	50		

C-FAP

FAST ACTING PROTECTORS

Type of Bi-directional trigger current with 1 circuit

● C-FAP-CA Series:Application Industrial and Consumer (RS Port Protection)

Part Number	Absolute Max.Ratings		Electrical Characteristic			Outer Dimensions (mm)	Overview
	Vimp(V)	Vrms(V)	Itrigger Min.(mA)	Itrigger Max.(mA)	RC-FAP (Ω)		
C-FAP-CA025-050-WH	250	100	50	100	13.3	6.5 x 4.00	
C-FAP-CA025-100-WH	250	100	100	200	7.1		
C-FAP-CA025-200-WH	250	100	200	400	4.2		
C-FAP-CA025-300-WH	250	100	300	600	3.2		
C-FAP-CA025-500-WH	250	100	500	1000	2.6		
C-FAP-CA040-050-WH	400	200	50	100	14.3		
C-FAP-CA040-100-WH	400	200	100	200	8.1		
C-FAP-CA040-200-WH	400	200	200	400	5.2		
C-FAP-CA040-300-WH	400	200	300	600	4.3		
C-FAP-CA040-500-WH	400	200	500	1000	3.6		
C-FAP-CA050-050-WH	500	250	50	100	15.7		
C-FAP-CA050-100-WH	500	250	100	200	9.5		
C-FAP-CA050-200-WH	500	250	200	400	6.6		
C-FAP-CA050-300-WH	500	250	300	600	5.6		
C-FAP-CA050-500-WH	500	250	500	1000	5.0		
C-FAP-CA065-050-WH	650	300	50	100	17.7		
C-FAP-CA065-100-WH	650	300	100	200	11.5		
C-FAP-CA065-200-WH	650	300	200	400	8.6		
C-FAP-CA065-300-WH	650	300	300	600	7.6		
C-FAP-CA065-500-WH	650	300	500	1000	7.0		
C-FAP-CA085-050-WH	850	425	50	100	21.4		
C-FAP-CA085-100-WH	850	425	100	200	15.2		
C-FAP-CA085-200-WH	850	425	200	400	12.3		
C-FAP-CA085-300-WH	850	425	300	600	11.3		
C-FAP-CA085-500-WH	850	425	500	1000	10.7		

C-FAP

FAST ACTING PROTECTORS

Type of Bi-directional trigger current, 2 circuit

- C-FAP-DT Series : Application for Industrial and Consumer (Gigabit Ethernet)

Part Number	Absolute Max. Ratings		Electrical Characteristic			Outer Dimensions (mm)	Overview
	Vimp(V)	Vrms(V)	Itrigger Min. (mA)	Itrigger Max. (mA)	Rc-FAP (Ω)		
C-FAP-DT065-100-WH	650	300	100	200	8.5	5.00 x 5.00	
C-FAP-DT065-200-WH	650	300	200	400	5.6		
C-FAP-DT065-300-WH	650	300	300	600	4.6		
C-FAP-DT065-500-WH	650	300	500	1000	4.0		
C-FAP-DT085-100-WH	850	425	100	200	10.3		
C-FAP-DT085-200-WH	850	425	200	400	7.4		
C-FAP-DT085-300-WH	850	425	300	600	6.8		
C-FAP-DT085-500-WH	850	425	500	1000	5.8		

DEFINITIONS OF PARAMETERS

- **Vimp** : Peak impulse voltage withstand with duration less than 10 ms.
- **Vrms** : Continuous A.C. RMS voltage
- **Itrigger** : Current required for device to go from operating state to protected state.
- **Rc-FAP** : Series resistance of C-FAP device (internal)

C-FAP

FAST ACTING PROTECTORS

TYPICAL CHARACTERISTICS

Lighting Surge test circuit

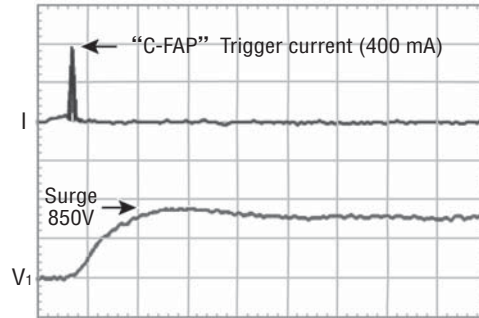
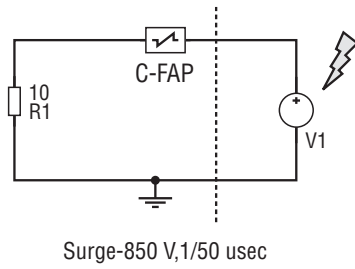

AC Power Cross test circuit

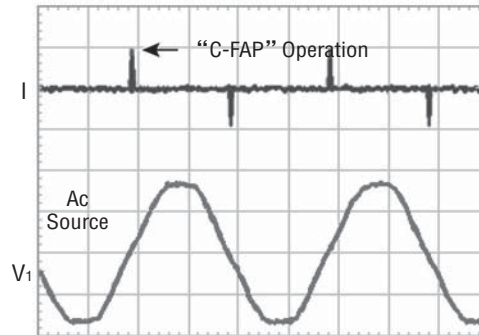
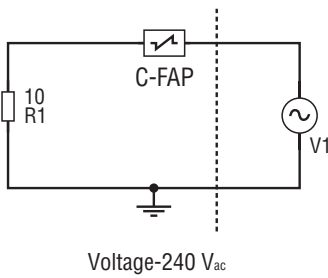

Frequency characteristic

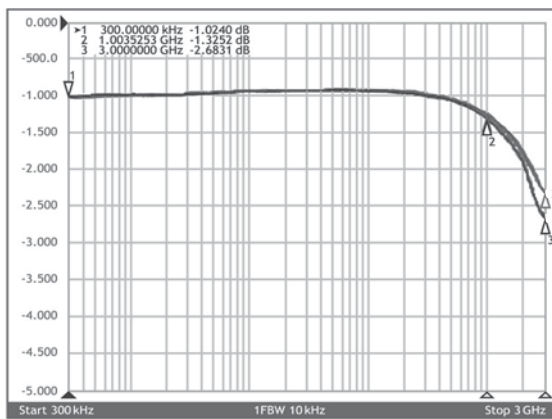

ENVIRONMENTAL CHARACTERISTICS

Item	Testing Condition	Standard	Specification
Operating Temp	—	—	-40~125 °C
Humidity	85 °C, 85 %RH, 1000 h	GR-357-CORE	Meets Specification
HAST	130 °C, 85 %RH, 96 h, no bias	GR-357-CORE	Meets Specification
Temp Cycle	-40 °C / 85 °C, 500 Cycle	MIL STD 883 Method 1010	Meets Specification
Solderability	Steam aging 8 h, 245 °C	JESD22 Method B102D(1)	Meets Specification

C-FAP

FAST ACTING PROTECTORS

SOLDER REFLOW RECOMENDATIONS

Profile Feature	Pb-Free Assembly
Average Ramp-Up Rate (T _{smax} to T _p)	3 °C/s max
Preheat <ul style="list-style-type: none"> • Temperature Min. (T_{smin}) • Temperature Max.(T_{smax}) • Time (t_{smin} To t_{smax}) 	150 °C 200 °C 60~180 s
Time maintained above <ul style="list-style-type: none"> • Temperature (T_L) • Time (t_L) 	217 °C 60~150 s
Peak/Classification temperature (t _p)	260 °C
Time within 5 °C of Actual Peak Temp.(t _p)	20~40 s
Ramp-Down Rate	6 °C/s max
Time 25 °C to Peak Temperature	8 s max.

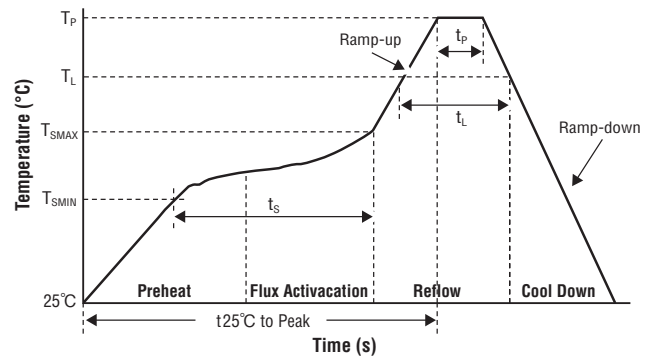

PACKAGING SPECIFICATION

- **Standard Packaging:** Tape and Reel Qty: 3,000 pcs/reel

EVALUATION BOARDS

We have prepared an evaluation board of C-FAP for each application.

Also, for individual evaluation board of C-FAP, please inquire to your nearest sales office.

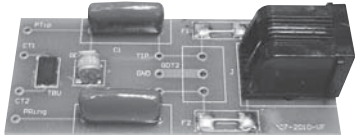
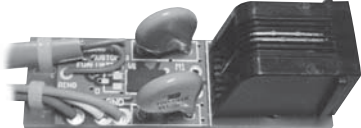
for RS-485	for VDSL	for SLIC
CA065-300-RS485 	CA050-500-VDSL 	PL085-200-SLIC 

Technical Notes and Application notes

Following documents are published on our homepage Web-catalog site.

No.	Title
Technical Note	Product outline of C-FAP
AN1	Protection for Cellular Base Station
AN2	Protection for LVDS Device
AN3	Protection for RS-485 Port
AN4	Evaluation board for RS-485 CA065-300-RS485
AN5	Evaluation board for VDSL CA050-500-VDSL
AN6	Evaluation board for SLIC PL085-200-SLIC