

## DOCSIS 3.0 Upstream Amplifier

## General Description

The MAX3518 is an integrated CATV upstream amplifier IC designed to meet the DOCSIS 3.0 requirements, while dissipating only 1.25W. The amplifier covers a 5MHz to 85MHz input frequency range (275MHz, 3dB bandwidth), and is capable of transmitting four QPSK modulated carriers, each at +58dBmV, simultaneously within this range. Both input and output ports are differential, requiring that an external balun be used at the output port. The gain is controlled in 1dB steps over a 63dB range using a SPI™ 3-wire interface.

The MAX3518 operates from a single +5V supply. Four power codes are provided to allow maximum supply current to be reduced as determined by distortion requirements. In addition, for each power code, supply current is automatically reduced as gain is reduced while maintaining distortion performance. For DOCSIS 3.0 applications, the MAX3518 draws 300mA at 33dB gain, dropping to 250mA at 31dB gain. The MAX3518 supply current drops to 5mA between bursts to minimize power dissipation in transmit-disable mode. Control logic levels are 3.3V CMOS.

The MAX3518 is available in a 20-pin thin QFN package, and operates over the extended industrial temperature range (-40°C to +85°C).

## Applications

DOCSIS 3.0 Cable Modems  
VOIP Modems  
Set-Top Boxes

SPI is a trademark of Motorola, Inc.

## Features

- ◆ +5V Supply Voltage
- ◆ Low Power: 1.25W at 31dB Gain, 64dBmV Output
- ◆ Ultra-Low 25mW Dissipation in Transmit-Disable Mode
- ◆ 63dB Gain Control Range in 1dB Steps
- ◆ -60dBc Harmonic Distortion at 64dBmV Output
- ◆ Small 5mm x 5mm Thin QFN Package
- ◆ Low Burst On/Off Transient
- ◆ 275MHz, 3dB Bandwidth

## Ordering Information

PART	TEMP RANGE	PIN PACKAGE
MAX3518ETP+	-40°C to +85°C	20 TQFN-EP*

+Denotes a lead(Pb)-free/RoHS-compliant package.

\*EP = Exposed pad.

## Pin Configuration/Functional Diagram

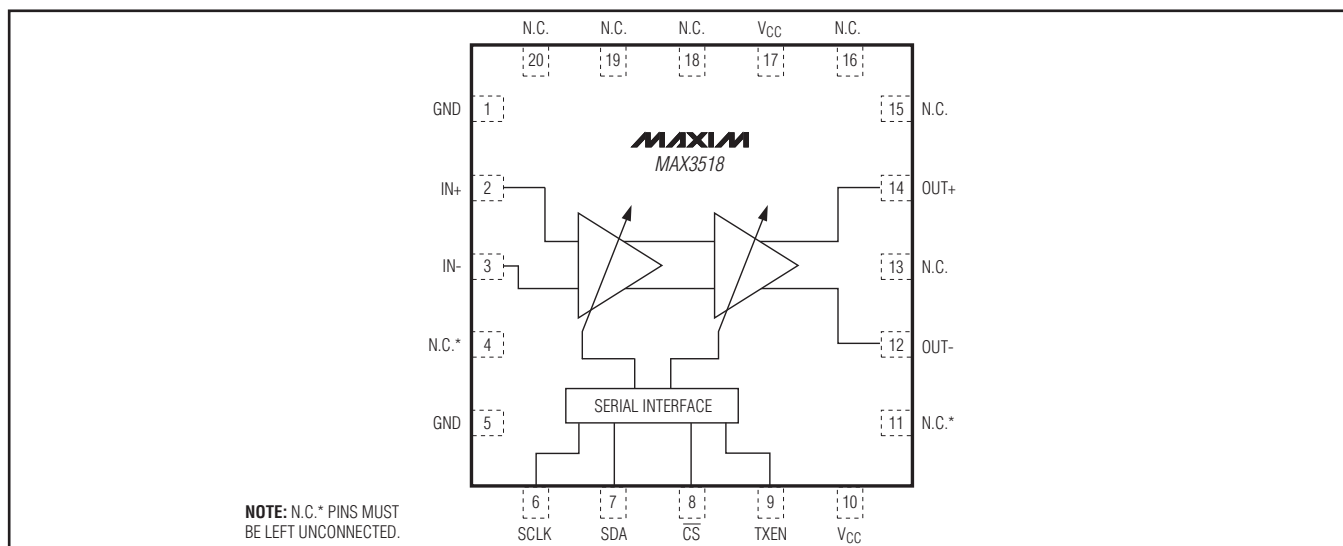

Typical Application Circuit appears at end of data sheet.

# DOCSIS 3.0 Upstream Amplifier

## ABSOLUTE MAXIMUM RATINGS

V <sub>CC</sub> to GND.....	-0.3V to +5.5V	Continuous Power Dissipation (T <sub>A</sub> = +70°C) (Note 1)
IN+, IN-.....	-0.3V to (V <sub>CC</sub> + 0.3V)	(derate 29mW/°C above T <sub>A</sub> = +70°C) ..... 2000mW
OUT+, OUT-.....	-0.3V to (V <sub>CC</sub> + 3.6V)	Operating Temperature Range ..... -40°C to +85°C
TXEN, SDA, SCLK, CS .....	-0.3V to +4.2V	Junction Temperature..... +150°C
RF Input Power.....	+10dBm	Storage Temperature Range..... -65°C to +165°C
		Lead Temperature (soldering, 10s)..... +300°C

**Note 1:** Package thermal resistances were obtained using the method described in JEDEC specification JESD51-7, using a four-layer board. For detailed information on package thermal considerations, refer to [www.maxim-ic.com/thermal-tutorial](http://www.maxim-ic.com/thermal-tutorial).

Stresses beyond those listed under "Absolute Maximum Ratings" may cause permanent damage to the device. These are stress ratings only, and functional operation of the device at these or any other conditions beyond those indicated in the operational sections of the specifications is not implied. Exposure to absolute maximum rating conditions for extended periods may affect device reliability.



**CAUTION!** ESD SENSITIVE DEVICE

## DC ELECTRICAL CHARACTERISTICS

(Typical Application Circuit as shown, V<sub>CC</sub> = 4.75V to 5.25V, V<sub>GND</sub> = 0, TXEN = high, T<sub>A</sub> = -40°C to +85°C, unless otherwise specified. Typical values are at V<sub>CC</sub> = 5V, T<sub>A</sub> = +25°C.) (Note 2)

PARAMETER	SYMBOL	CONDITIONS	MIN	TYP	MAX	UNITS
Supply Voltage	V <sub>CC</sub>		4.75		5.25	V
Supply Current Transmit Mode	I <sub>CC</sub>	Gain code = 63, power code = 3 (33dB gain typ)		290	315	mA
		Gain code = 59, power code = 1 (29dB gain typ)		160		
Supply Current Transmit Disable Mode	I <sub>CC</sub>	TXEN = low		5	6.5	mA
Input High Voltage	V <sub>INH</sub>		2.0		3.6	V
Input Low Voltage	V <sub>INL</sub>				0.7	V
Input High Current	I <sub>BIASH</sub>				10	μA
Input Low Current	I <sub>BIASH</sub>		-10			μA

## AC ELECTRICAL CHARACTERISTICS

(Typical Application Circuit as shown, V<sub>CC</sub> = 4.75V to 5.25V, V<sub>GND</sub> = 0, TXEN = high, T<sub>A</sub> = -40°C to +85°C, unless otherwise specified. Typical values are at V<sub>CC</sub> = 5V, T<sub>A</sub> = +25°C.) (Note 2)

PARAMETER	SYMBOL	CONDITIONS	MIN	TYP	MAX	UNITS
Frequency Range	f <sub>IN</sub>	(Note 3)	5		85	MHz
Voltage Gain, Z <sub>IN</sub> = 200Ω, Z <sub>OUT</sub> = 75Ω, Power Code = 3 (Note 4)	A <sub>V</sub>	Gain code = 63	32	33	34	dB
		Gain code = 53	22	23	24	
		Gain code = 43	12	13	14	
		Gain code = 33	2	3	4	
		Gain code = 23	-8	-7	-6	
		Gain code = 13	-18	-17	-16	
		Gain code = 03	-28	-27	-26	
Voltage Gain Variation with Power Code, Any Gain Code				±0.1		dB
Gain Rolloff		Voltage gain = -28dB to +33dB, f <sub>IN</sub> = 5MHz to 85MHz		-0.3		dB
Gain Step Size		Voltage gain = -28dB to +33dB, f <sub>IN</sub> = 5MHz to 85MHz	0.7	1.0	1.3	dB

# DOCSIS 3.0 Upstream Amplifier

MAX3518

## AC ELECTRICAL CHARACTERISTICS (continued)

(Typical Application Circuit as shown,  $V_{CC} = 4.75V$  to  $5.25V$ ,  $V_{GND} = 0$ ,  $TXEN = \text{high}$ ,  $T_A = -40^\circ C$  to  $+85^\circ C$ , unless otherwise specified. Typical values are at  $V_{CC} = 5V$ ,  $T_A = +25^\circ C$ .) (Note 2)

Transmit-Disable Mode Noise		Any BW = 160kHz from 5MHz to 85MHz, $TXEN = \text{low}$ , voltage gain = $-27\text{dB}$ to $+33\text{dB}$ (Note 5)	-66		dBmV
Isolation in Transmit-Disable Mode		$TXEN = \text{low}$	80		dB
Noise Figure	NF	Transmit mode, voltage gain = $+13\text{dB}$ to $+33\text{dB}$ (Note 5)	11		dB
Noise Figure Slope		Transmit mode, voltage gain = $-27\text{dB}$ to $+33\text{dB}$	-1.0		dB/dB
Transmit-Disable/Transmit-Enable Transient Duration		$TXEN$ input rise/fall time $< 0.1\mu s$	2		$\mu s$
Transmit-Disable/Transmit-Enable Transient Step Size		Gain = $33\text{dB}$	25	50	mV <sub>P-P</sub>
		Gain = $4\text{dB}$	1		
Input Impedance	$Z_{IN}$	Balanced	200		$\Omega$
Input Return Loss		$200\Omega$ system	15		dB
Output Return Loss		$75\Omega$ system (Note 5)	11	15	dB
Output Return Loss in Transmit-Disable Mode		$75\Omega$ system, $TXEN = \text{low}$ (Note 5)	11	15	dB
2nd Harmonic Distortion	HD2	Input tone at $33\text{dBmV}$ , $V_{OUT} = +64\text{dBmV}$ , power code = 3 (Note 5)	-70	-57	dBc
3rd Harmonic Distortion	HD3	Input tone at $33\text{dBmV}$ , $V_{OUT} = +64\text{dBmV}$ , power code = 3 (Note 5)	-60	-56	dBc
Two-Tone 2nd-Order Distortion	IM2	Input tones at $30\text{dBmV}$ , $V_{OUT} = +61\text{dBmV}/\text{tone}$ , power code = 3 (Note 5)	-70	-57	dBc
Two-Tone 3rd-Order Distortion	IM3	Input tones at $30\text{dBmV}$ , $V_{OUT} = +61\text{dBmV}/\text{tone}$ , power code = 3 (Note 5)	-60	-54	dBc
Four Tone Spurs		Four input tones at $27\text{dBmV}$ , $V_{OUT} = +58\text{dBmV}/\text{tone}$ , power code = 3	-55		dBc
Output 1dB Compression Point	P1dB	Gain = $33\text{dB}$	74		dBmV

## TIMING CHARACTERISTICS

(Typical Application Circuit as shown,  $V_{CC} = 4.75V$  to  $5.25V$ ,  $V_{GND} = 0$ ,  $T_A = -40^\circ C$  to  $+85^\circ C$ , unless otherwise specified. Typical values are at  $V_{CC} = 5V$ ,  $T_A = +25^\circ C$ .) (Note 2)

PARAMETER	SYMBOL	CONDITIONS	MIN	TYP	MAX	UNITS
SEN to SCK Rise Set Time	$t_{SENS}$			20		ns
SEN to SCK Rise Hold Time	$t_{SENH}$			10		ns
SDA to SCK Setup Time	$t_{SDAS}$			20		ns
SDA to SCK Hold Time	$t_{SDAH}$			10		ns
SCK Pulse-Width High	$t_{SCLKH}$			50		ns
SCK Pulse-Width Low	$t_{SCLKL}$			50		ns
Maximum CLK Frequency			10			MHz

**Note 2:** Min/max values are production tested at  $T_A = +85^\circ C$ .

**Note 3:** Production tested at 10MHz and 85MHz.

**Note 4:** Voltage gain does not include loss due to input and output transformers.

**Note 5:** Guaranteed by design and characterization.

# DOCSIS 3.0 Upstream Amplifier

## Typical Operating Characteristics

(MAX3518 EV kit,  $V_{CC} = +5V$ ,  $V_{IN} = 33dBmV$ ,  $f_{IN} = 42MHz$ ,  $Z_{LOAD} = 75\Omega$ ,  $T_A = +25^\circ C$ , power code = 3, unless otherwise noted.)

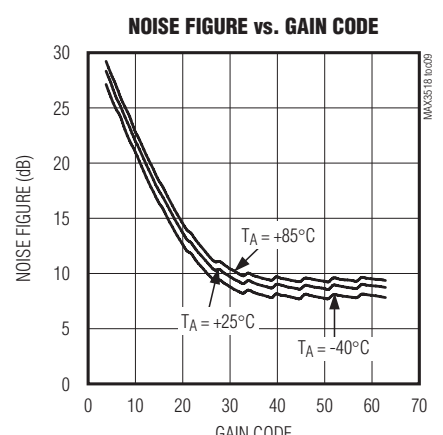
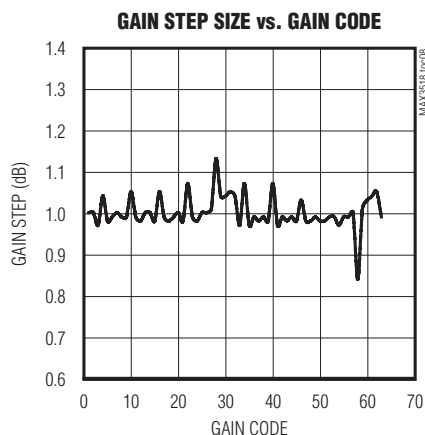
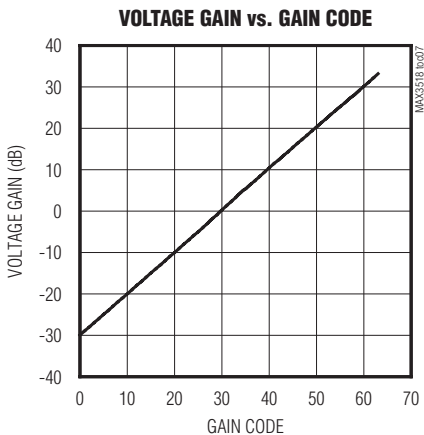
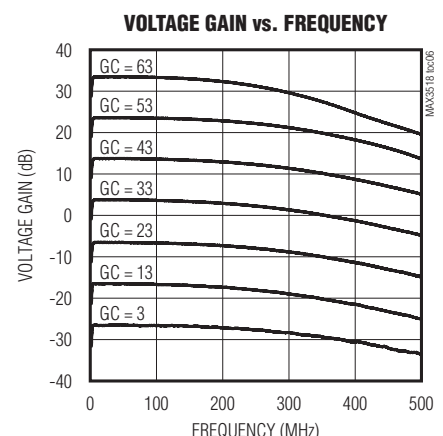
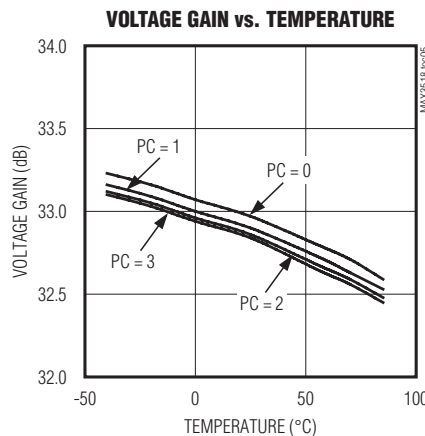
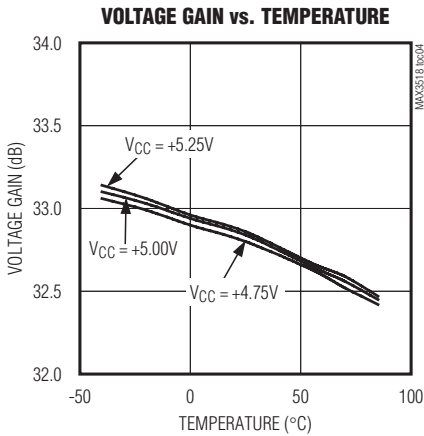
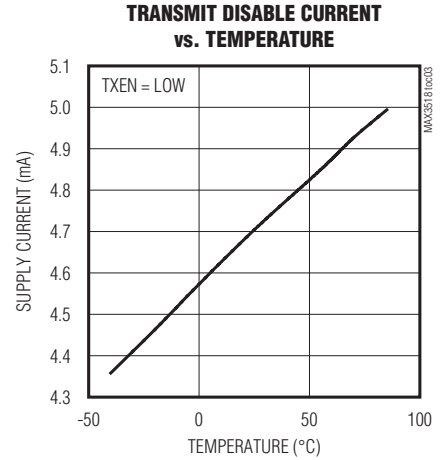
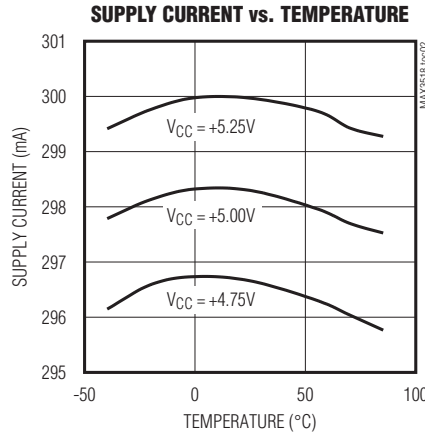
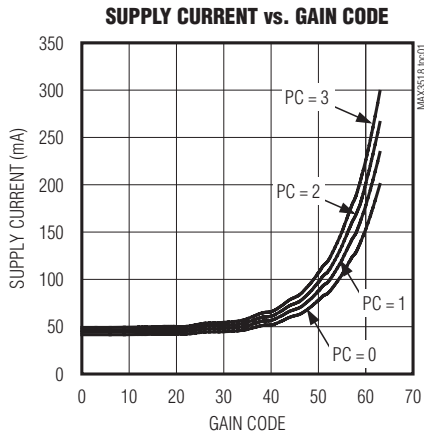

# DOCSIS 3.0 Upstream Amplifier

MAX3518

## Typical Operating Characteristics (continued)

(MAX3518 EV kit,  $V_{CC} = +5V$ ,  $V_{IN} = 33dBmV$ ,  $f_{IN} = 42MHz$ ,  $Z_{LOAD} = 75\Omega$ ,  $T_A = +25^\circ C$ , power code = 3, unless otherwise noted.)

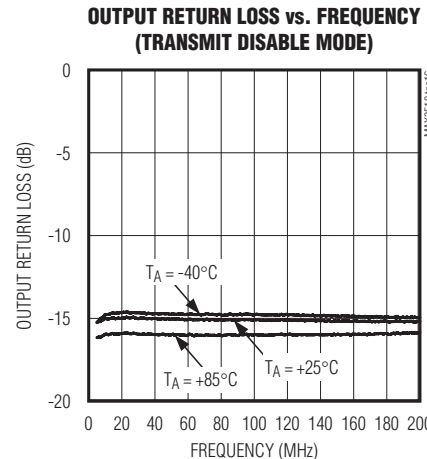
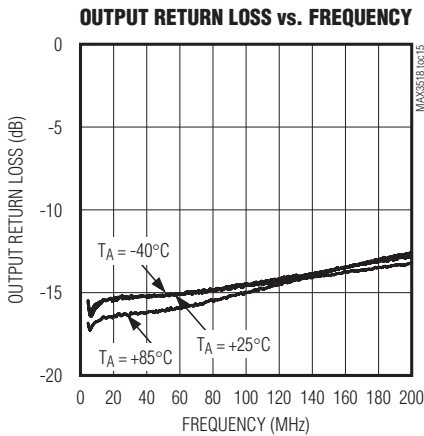
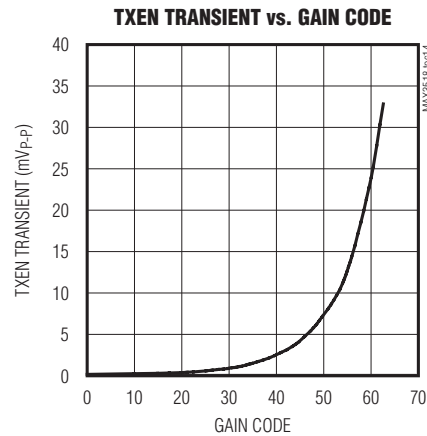
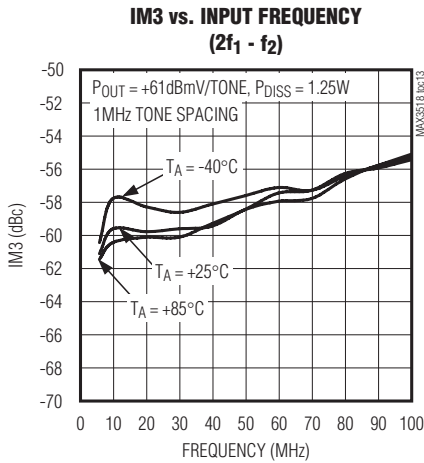
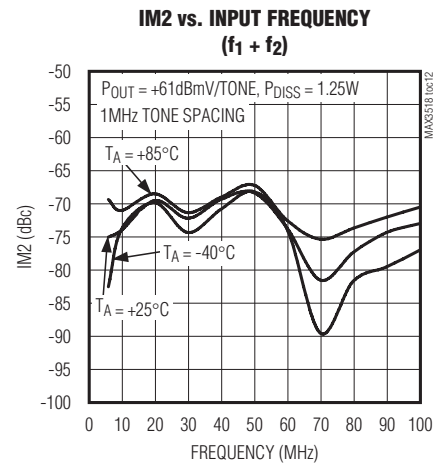
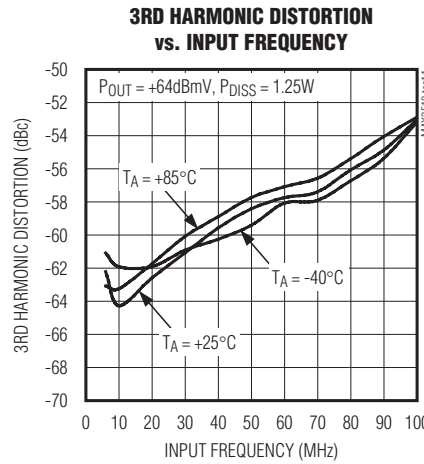
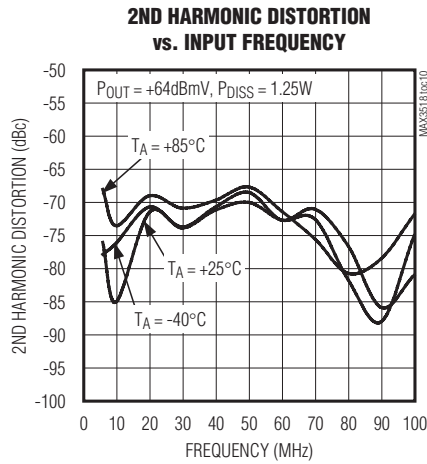

# DOCSIS 3.0 Upstream Amplifier

## Pin Description

PIN	NAME	FUNCTION
1, 5	GND	Ground
2	IN+	Positive PGA Input
3	IN-	Negative PGA Input
4, 11	N.C.	No Connection. These pins must remain open.
6	SCLK	Serial Interface Clock
7	SDA	Serial Interface Data
8	$\overline{CS}$	Serial Interface Enable
9	TXEN	Transmit Enable. TXEN = high places the device in transmit mode.
10	VCC	Supply Voltage for Serial Interface
12	OUT-	Negative Output
13, 15, 16, 18, 19, 20	N.C.	No Connection. Connect these pins to ground.
14	OUT+	Positive Output
17	VCC	Supply Voltage for Programmable-Gain Amplifier (PGA)
—	EP	Ground

**Table 1. Register Description**

REGISTER NAME	REGISTER ADDRESS	DATA 8 BITS							
		B7	B6	B5	B4	B3	B2	B1	B0
Power/Gain	0000	PC2	PC1	GC5	GC4	GC3	GC2	GC1	GC0
Initialize	0001	0	0	0	0	0	0	0	0

## Detailed Description

### Programmable-Gain Amplifier

The programmable-gain amplifier (PGA) provides 63dB of output level control in 1dB steps. The gain of the PGA is determined by a 6-bit gain code (GC5–GC0) programmed through the serial data interface (Tables 1 and 2). Specified performance is achieved when the input is driven differentially.

Four power codes (PC1–PC0) allow the PGA to be used with reduced bias current when distortion performance can be relaxed. In addition, for each power code, bias current is automatically reduced with gain code for maximum efficiency.

The PGA features a differential Class A output stage capable of driving four +58dBmV QPSK modulated signals, or a single +64dBmV QPSK modulated signal into a 75Ω load. This architecture provides superior even-order distortion performance but requires that a transformer be used to convert to a single-ended output. In transmit-disable mode, the output amplifiers are powered down, resulting in low output noise, while maintaining impedance match.

### 3-Wire Serial Interface (SPI) and Control Registers

The MAX3518 includes two programmable registers for initializing the part and setting the gain and power consumption. The 4 MSBs are address bits; the 8 least significant bits (LSBs) are used for register data. Data is shifted MSB first.

**Note:** The registers must be written 100μs after the device is powered up, and no earlier. Once a new set of register data is clocked in, the corresponding power code and/or gain code does not take effect until TXEN transitions from high to low.

## Applications Information

### Power Codes

The MAX3518 is designed to meet the stringent linearity requirements of DOCSIS 3.0 using power code (PC) 3. For DOCSIS 2.0, PC = 1 is recommended, which results in substantial supply current reduction. The full range of gain codes can be used in any power code. The gain difference between power codes is typically less than 0.1dB.

# DOCSIS 3.0 Upstream Amplifier

MAX3518

**Table 2. Reg 00 Gain Control**

BIT NAME	BIT LOCATION (0 = LSB)	RECOMMENDED DEFAULT	FUNCTION
PC[1:0]	7,6	11	Sets the power code, which controls the bias current drawn by the device in transmit mode: 11 - PC = 3, maximum current draw . . . 00 - PC = 0, minimum current draw (See the <i>Typical Operating Characteristics</i> .)
GC[5:0]	5,4,3,2,1,0	11 1111	Sets the gain code, which determines the voltage gain of the amplifier: 11 1111 - GC = 63, voltage gain = 33dB (typ). 11 1110 - GC = 62, voltage gain = 32dB (typ). . . . 00 0011 - GC = 03, voltage gain = -27dB (typ). (See the <i>AC Electrical Characteristics</i> .)

**Table 3. Initialize Register**

BIT NAME	BIT LOCATION (0 = LSB)	RECOMMENDED DEFAULT	FUNCTION
—	7,6,5,4,3,2,1,0	0000 0000	Must be programmed to 0000 0000 upon power-up for specified performance.

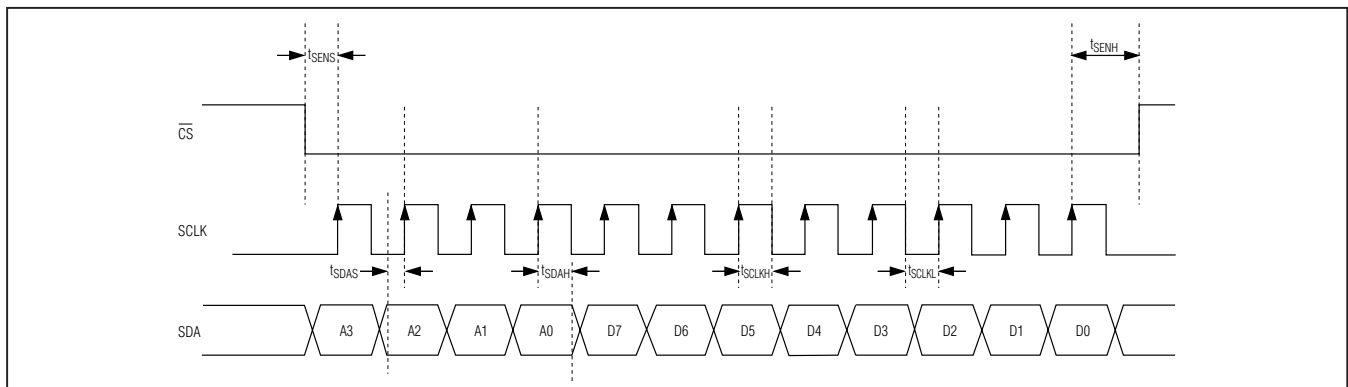

Figure 1. SPI 3-Wire Interface Timing Diagram

### Transmit Disable Mode

Between bursts in a DOCSIS system, the MAX3518 should be put in transmit-disable mode by setting TXEN low. The output transient on the cable is kept well below the DOCSIS requirement during the TXEN transitions.

If a gain or power change is required, new values of PC and GC should be clocked in during transmit operation (TXEN low). The new operating point of the MAX3518 is set when TXEN transitions low during the time between bursts.

### Output Transformer

The MAX3518 output circuits are open-collector differential amplifiers. On-chip resistors across the collectors provide a nominal output impedance of 75Ω in transmit mode and transmit-disable mode. To match the output of the MAX3514/MAX3516 to a single-ended 75Ω load, a 1:1 transformer is required. This transformer must have adequate bandwidth to cover the intended application. Note that some RF transformers specify bandwidth with a 50Ω source on the primary and a matching

# DOCSIS 3.0 Upstream Amplifier

resistance on the secondary winding. Operating in a  $75\Omega$  system tends to shift the low-frequency edge of the transformer bandwidth specification up by a factor of 1.5 due to primary inductance. Keep this in mind when specifying a transformer.

Bias to the output stage is provided through the center tap on the transformer primary. This greatly diminishes the on/off transients present at the output when switching between transmit and transmit-disable modes. Commercially available transformers typically have adequate balance between half-windings to achieve substantial transient cancellation.

Finally, keep in mind that transformer core inductance varies with temperature. Adequate primary inductance must be present to sustain broadband output capability as temperatures vary.

## Input Circuit

To achieve rated performance, the inputs of the MAX3518 must be driven differentially with an appropriate input level. The differential input impedance is  $200\Omega$ . Most applications require an anti-alias filter preceding the device. The filter should be designed to match this  $200\Omega$  impedance.

The MAX3518 has sufficient gain to produce an output level of 64dBmV QPSK when driven with a +33dBmV input signal. If an input level greater than +34dBmV is used, the 3rd-order distortion performance will degrade slightly.

## Layout Issues

A well-designed printed circuit board (PCB) is an essential part of an RF circuit. For best performance, pay attention to power-supply layout issues as well as the output circuit layout.

## No Connect Pins

Pins 4 and 11 must be left open, not connected to supply or ground or any other node in the circuit. Pins 13, 15, 16, 18, 19, and 20 should be connected to ground.

## Output Circuit Layout

The differential implementation of the MAX3518 output has the benefit of significantly reducing even-order distortion, the most significant of which is 2nd-harmonic distortion. The degree of distortion cancellation depends on the amplitude and phase balance of the overall circuit. It is important to keep the trace lengths from the output pins equal.

## Power-Supply Layout

For minimal coupling between different sections of the IC, the ideal power-supply layout is a star configuration. This configuration has a large-value decoupling capacitor at the central power-supply node. The power-supply traces branch out from this node, each going to a separate power-supply node in the circuit. At the end of each of these traces is a decoupling capacitor that provides a very low impedance at the frequency of interest. This arrangement provides local power-supply decoupling at each power-supply pin. The power-supply traces must be capable of carrying the maximum current without significant voltage drop.

The output transformer center tap node, VCC\_CT, must be connected to supply through a  $3\Omega$  resistor to reduce the supply voltage on OUT+ and OUT-. This resistor must be rated to dissipate 250mW at +85°C.

## Exposed Pad Thermal Considerations

The exposed pad (EP) of the MAX3518's 20-pin TQFN package provides a low thermal resistance path to the die. It is important that the PCB on which the MAX3518 is mounted be designed to conduct heat from this contact. In addition, the EP should be provided with a low-inductance path to electrical ground.

It is recommended that the EP be soldered to a ground plane on the PCB, either directly or through an array of plated via holes.

## Chip Information

PROCESS: SiGe BiCMOS



# DOCSIS 3.0 Upstream Amplifier

**MAX3518**

## Typical Application Circuit

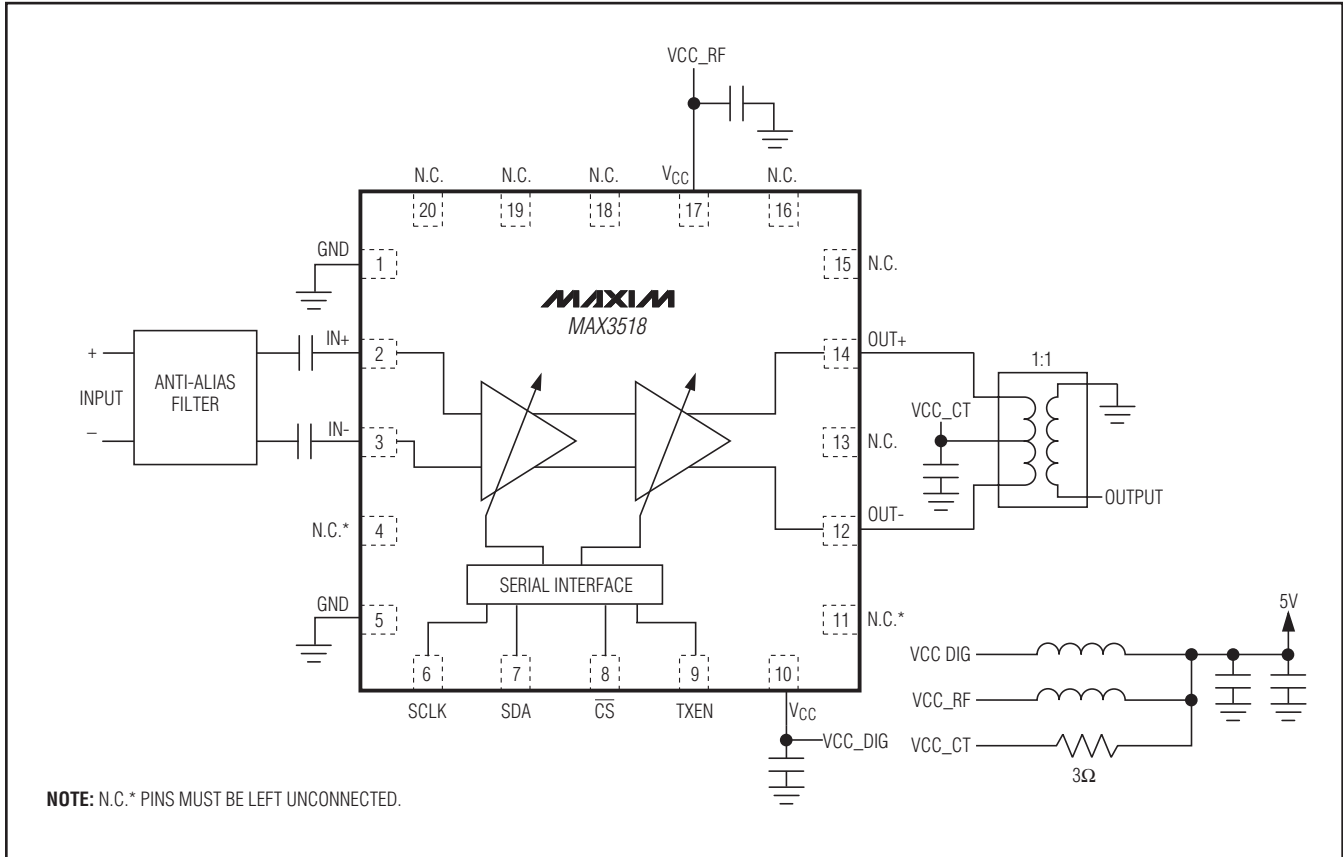

## Package Information

For the latest package outline information and land patterns, go to [www.maxim-ic.com/packages](http://www.maxim-ic.com/packages).

PACKAGE TYPE	PACKAGE CODE	DOCUMENT NO.
20 TQFN-EP	T2055-5	<a href="#">21-140</a>

Maxim cannot assume responsibility for use of any circuitry other than circuitry entirely embodied in a Maxim product. No circuit patent licenses are implied. Maxim reserves the right to change the circuitry and specifications without notice at any time.

Maxim Integrated Products, 120 San Gabriel Drive, Sunnyvale, CA 94086 408-737-7600 \_\_\_\_\_ 9