

CMOS LDO Regulator for Portable Equipments

# High Ripple Rejection, Low Current Consumption, Versatile Package FULL CMOS LDO Regulator (500mA)

**BUXXTH5WNVX**

**General Description**

BUXXTH5WNVX is high-performance FULL CMOS regulator with 500-mA output, which is mounted on versatile package SSON004X1010 (1.00mm × 1.00 mm × 0.60mm). It has excellent ripple rejection, noise characteristics and load responsiveness characteristics despite its low circuit current consumption of 10µA. It is most appropriate for various applications such as power supplies for logic IC, RF, and camera modules.

**Features**

- High accuracy detection
- High ripple rejection
- low current consumption
- Compatible with small ceramic capacitor (C<sub>in</sub>=C<sub>o</sub>=1.0µF)
- With built-in output discharge circuit
- ON/OFF control of output voltage
- With built-in over current protection circuit

**Key Specifications**

- Load Current: 500mA
- Accuracy output voltage: ±1.0%
- Power Supply rejection Ratio: 80dB@1KHz
- Low current consumption: 10µA (TYP)
- Operating temperature range: -20°C to +85°C

**Applications**

Smartphone, Battery-powered portable equipment, etc.

**Package**

SSON004X1010 : 1.00mm x 1.00mm x 0.60mm

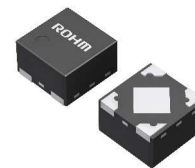

**Typical Application Circuit**

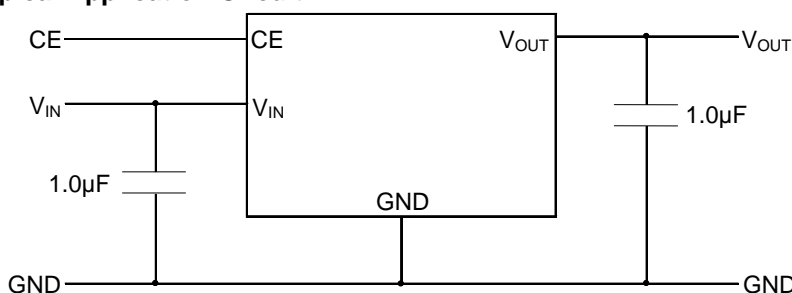
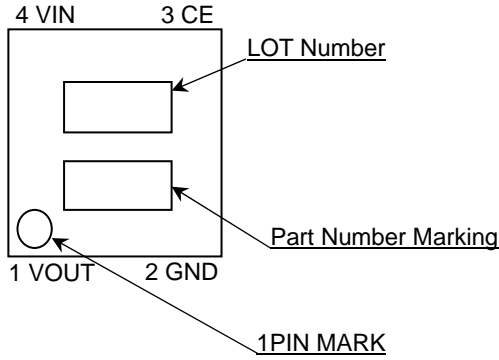

Figure 1. Application Circuit

Connection Diagram

SSON004X1010 TOP VIEW



BOTTOM VIEW

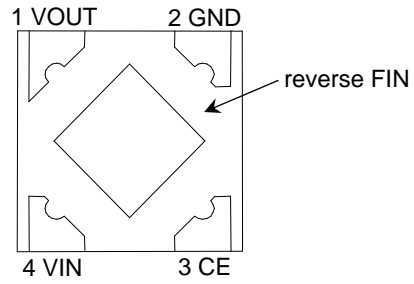

Pin Descriptions

SSON004X1010		
PIN No.	Symbol	Function
1	VOUT	Output Voltage
2	GND	Grounding
3	CE	ON/OFF control of output voltage (High: ON, Low: OFF)
4	VIN	Power Supply Voltage
reverse	FIN	Substrate (Connect to GND)

Ordering Information

B U X X T H 5 W N V X - 1 T L

Part Number	Output Voltage 1A : 1.05V ↓ 35 : 3.50V	High Ripple Rejection Maximum Output Current 500mA	with output discharge	Package NVX : SSON004X1010	None: Chip Rev.1 1: Chip Rev.2 (XX=1A,12)	Packaging and forming specification Embossed tape and reel TL : The pin number 1 is the lower left
-------------	---	--	-----------------------	-------------------------------	---	--

SSON004X1010

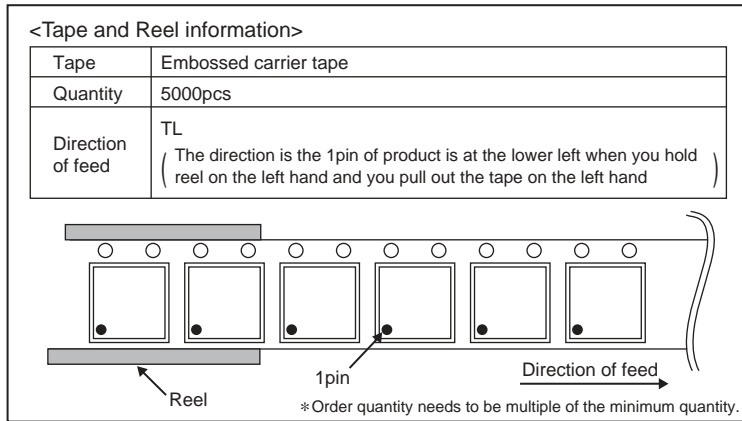
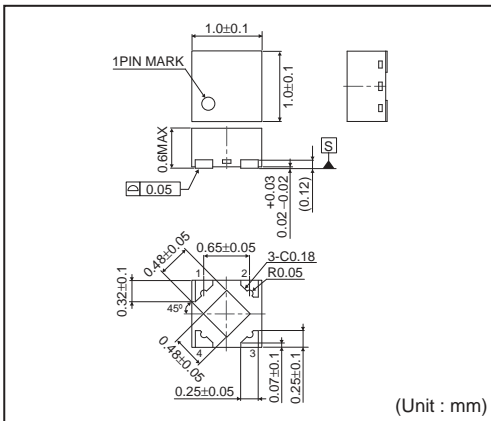

Lineup

Marking	Di	Ci	6i	Ai
Output Voltage	1.05V	1.20V	2.85V	3.50V
Part Number	BU1ATH5WNVX-1	BU12TH5WNVX-1	BU2JTH5WNVX	BU35TH5WNVX

**Absolute Maximum Ratings (Ta=25°C)**

PARAMETER	Symbol	Limit	Unit
Power Supply Voltage	V <sub>MAX</sub>	-0.3 to +6.5	V
Power Dissipation	P <sub>d</sub>	560 <sup>(Note1)</sup>	mW
Maximum junction temperature	T <sub>JMAX</sub>	+125	°C
Operating Temperature Range	T <sub>opr</sub>	-20 to +85	°C
Storage Temperature Range	T <sub>stg</sub>	-55 to +125	°C

(Note1) P<sub>d</sub> deleted at 5.6mW/°C at temperatures above Ta=25°C, mounted on 70x70x1.6 mm glass-epoxy PCB.

**Caution:** Operating the IC over the absolute maximum ratings may damage the IC. The damage can either be a short circuit between pins or an open circuit between pins and the internal circuitry. Therefore, it is important to consider circuit protection measures, such as adding a fuse, in case the IC is operated over the absolute maximum ratings.

**RECOMMENDED OPERATING RANGE (not to exceed Pd)**

PARAMETER	Symbol	Limit	Unit
Power Supply Voltage	V <sub>IN</sub>	1.7 to 6.0	V
Maximum Output Current	I <sub>MAX</sub>	500	mA

**OPERATING CONDITIONS**

PARAMETER	Symbol	MIN.	TYP.	MAX.	Unit	CONDITION
Input Capacitor	C <sub>in</sub>	1.0 <sup>(Note2)</sup>	-	-	μF	Ceramic capacitor recommended
Output Capacitor	C <sub>o</sub>	1.0 <sup>(Note2)</sup>	-	-	μF	

(Note2) Make sure that the output capacitor value is not kept lower than this specified level across a variety of temperature, DC bias, changing as time progresses characteristic.

**Electrical Characteristics**

(Ta=25°C, V<sub>IN</sub>=V<sub>OUT</sub>+1.0V, C<sub>IN</sub>=1.0μF, C<sub>o</sub>=1.0μF, unless otherwise noted.)

Parameter	Symbol	Limits			Unit	Conditions	
		Min.	Typ.	Max.			
Input Voltage	V <sub>IN</sub>	1.7	-	6.0	V		
Output Voltage	V <sub>OUT</sub>	V <sub>OUT</sub> -25mV	V <sub>OUT</sub>	V <sub>OUT</sub> +25mV	V	I <sub>OUT</sub> =10μA, V <sub>OUT</sub> <2.5V	
		V <sub>OUT</sub> ×0.99		V <sub>OUT</sub> ×1.01	V	I <sub>OUT</sub> =10μA, V <sub>OUT</sub> ≥2.5V	
Line Regulation	ΔV <sub>OUT-line</sub>	-	-	20	mV	From (V <sub>OUT</sub> +0.3V) to 5.0V, I <sub>OUT</sub> =10mA	
Load Regulation	ΔV <sub>OUT-load</sub>	-	21	40	mV	I <sub>OUT</sub> =5mA to 250mA	
Voltage Dropout	ΔV <sub>drop-out</sub>	-	520	700	mV	V <sub>OUT</sub> =1.05V (I <sub>OUT</sub> =250mA)	
		-	440	550	mV	V <sub>OUT</sub> =1.20V (I <sub>OUT</sub> =250mA)	
		-	160	250	mV	V <sub>OUT</sub> =2.85V (I <sub>OUT</sub> =250mA)	
		-	150	230	mV	V <sub>OUT</sub> =3.50V (I <sub>OUT</sub> =250mA)	
Load Current	I <sub>load</sub>	500	-	-	mA		
No Load Quiescent Current	I <sub>cq</sub>	-	10	20	μA	I <sub>OUT</sub> =0mA	
Power Supply Rejection Ratio	RR1	-	82	-	dB	f <sub>RR</sub> =100Hz	
	RR2	-	80	-	dB	f <sub>RR</sub> =1kHz	
Output Noise Voltage	Noise	-	40	-	nV√Hz	@10KHz	
Operating Temperature range	T <sub>opr</sub>	-20	-	85	°C		
Discharge Resistor	RDSC	20	50	80	Ω		
CE Pin Pull-down Current	ISTB	0.1	0.9	8.0	uA		
CE Pin Control Voltage	ON	V <sub>CEH</sub>	1.2	-	6.0	V	
	OFF	V <sub>CEL</sub>	-0.3	-	0.3	V	

Block Diagrams

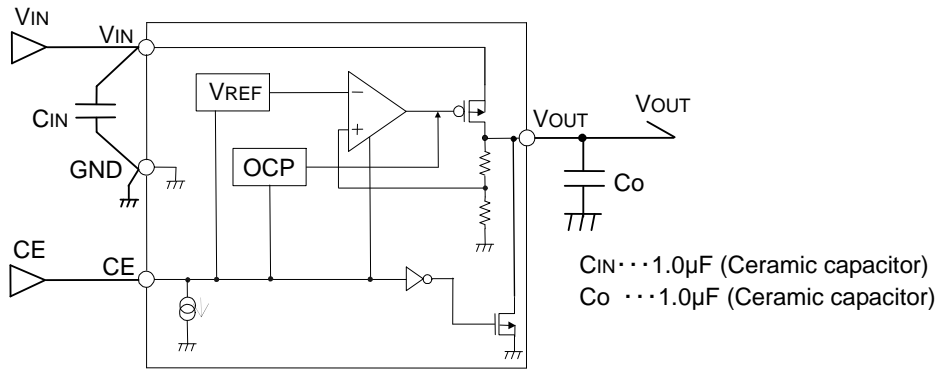

Figure 2. Block Diagrams

Reference data BU1ATH5WNVX (Ta=25°C unless otherwise specified.)

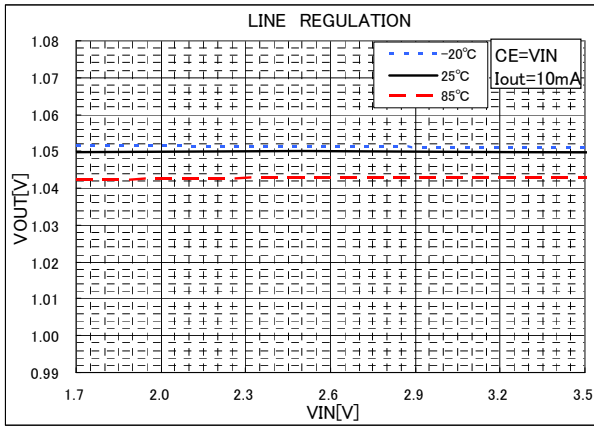

Figure 3.

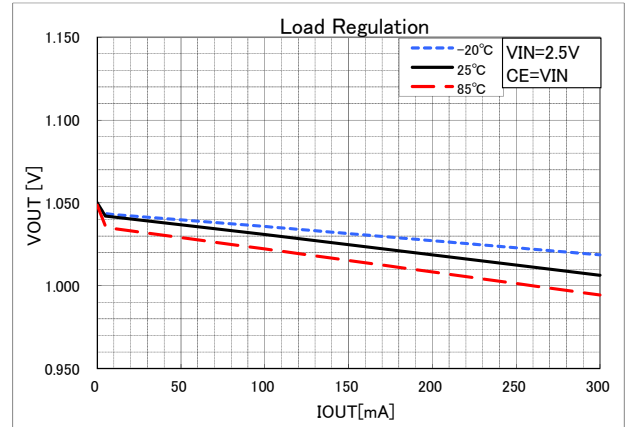

Figure 4.

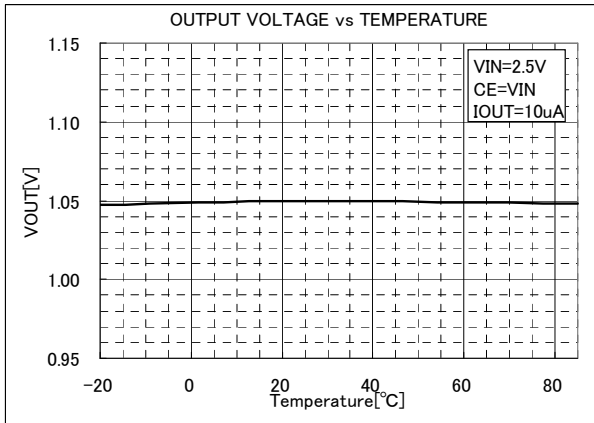

Figure 5.

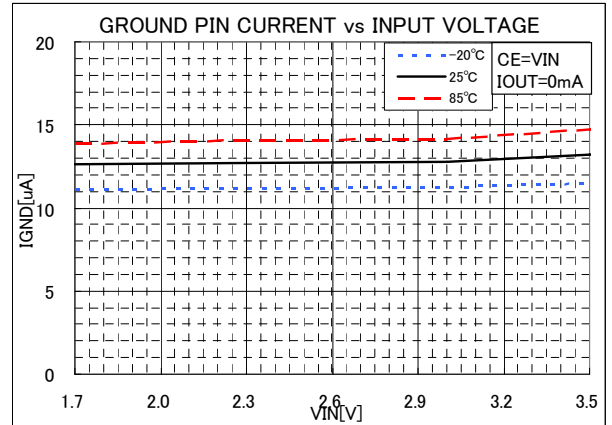

Figure 6.

Reference data BU1ATH5WNVX (Ta=25°C unless otherwise specified.)

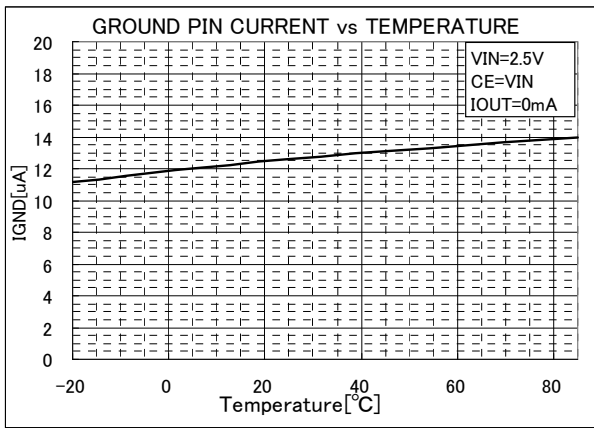

Figure 7.

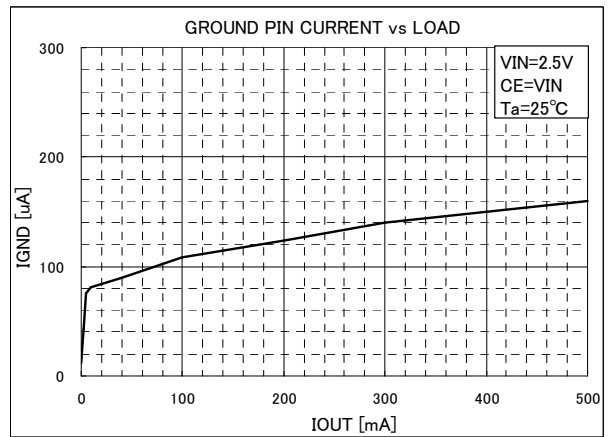

Figure 8.

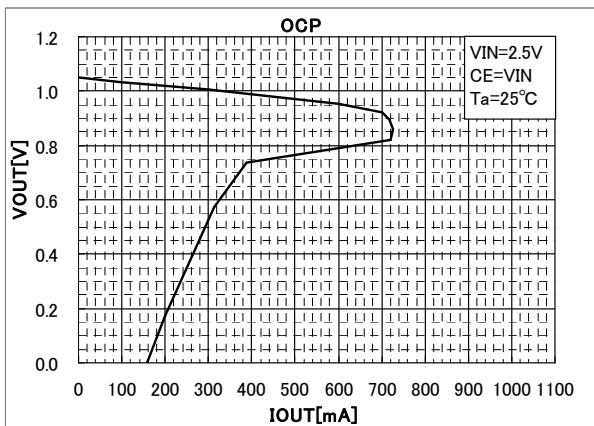

Figure 9.

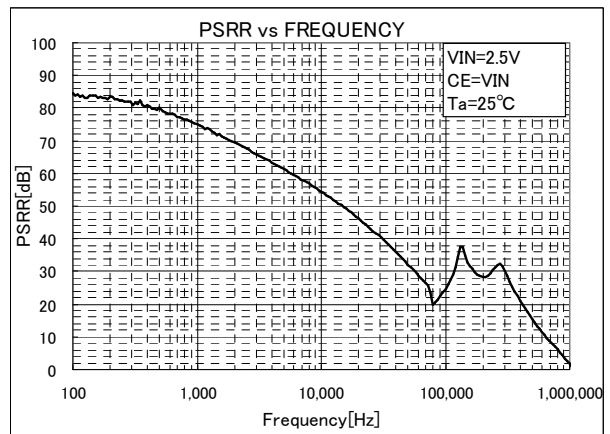

Figure 10.

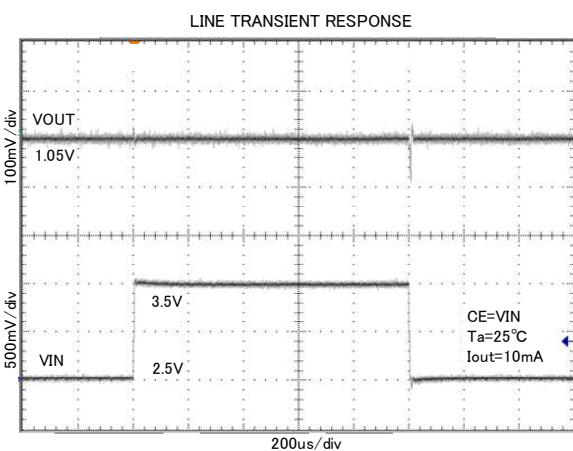

Figure 11.

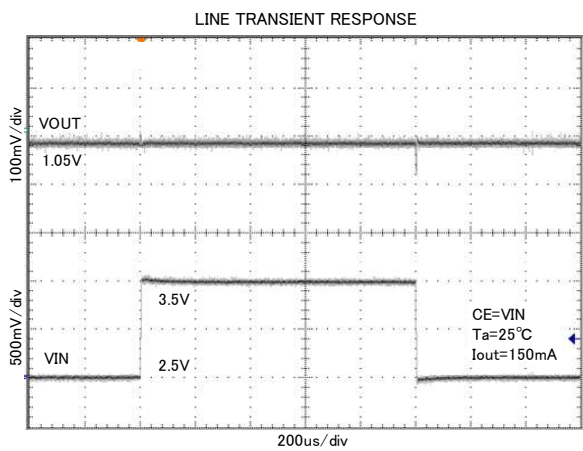

Figure 12.

Reference data BU1ATH5WNVX (Ta=25°C unless otherwise specified.)

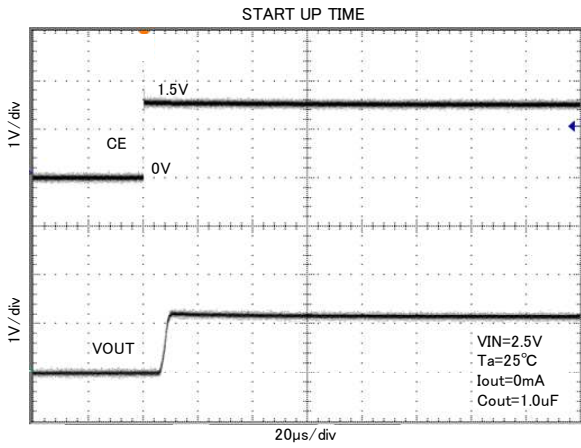

Figure 13.

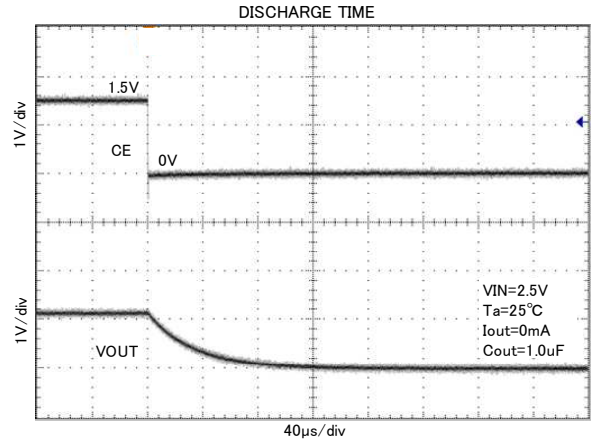

Figure 14.

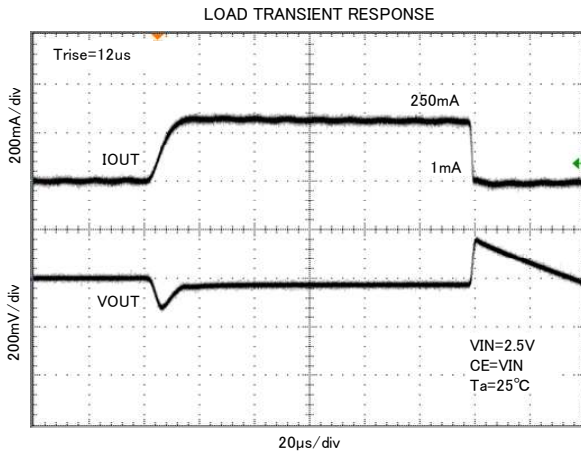

Figure 15.

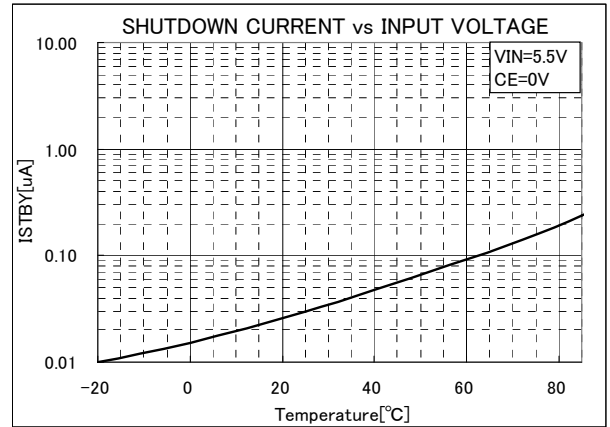

Figure 16.

Reference data BU12TH5WNVX-1 (Ta=25°C unless otherwise specified.)

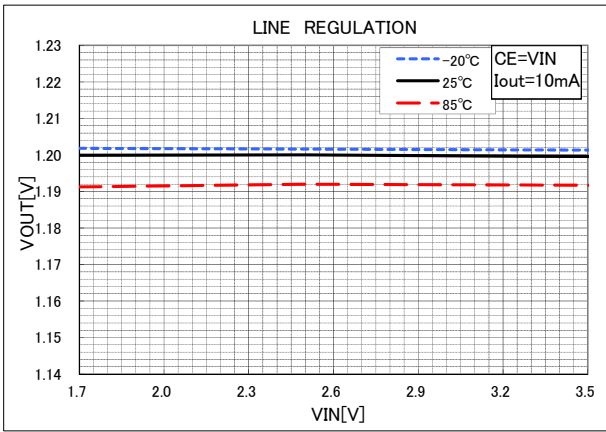

Figure 17.

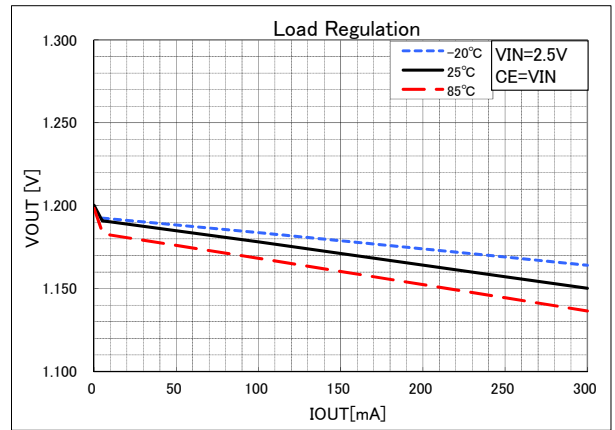

Figure 18.

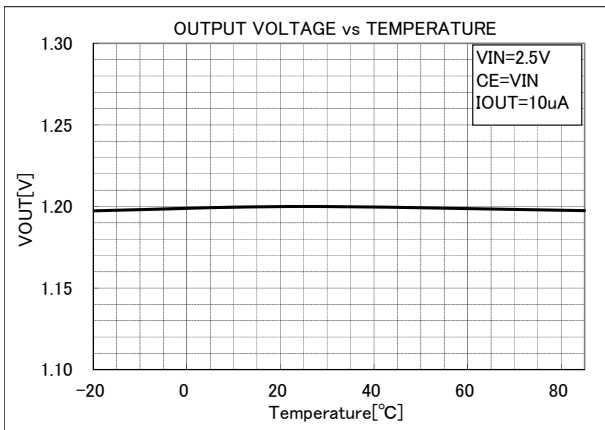

Figure 19.

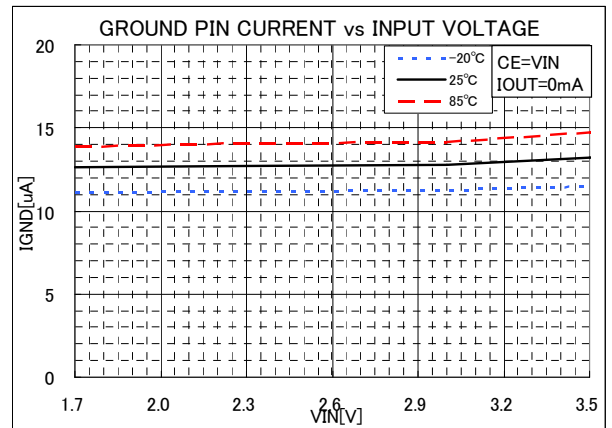

Figure 20.



Reference data BU12TH5WNVX-1 (Ta=25°C unless otherwise specified.)

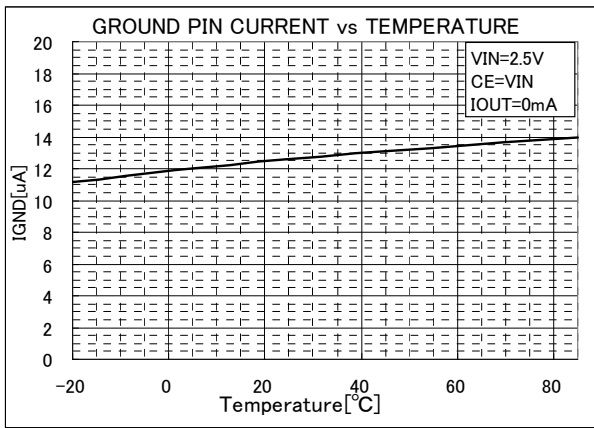

Figure 21.

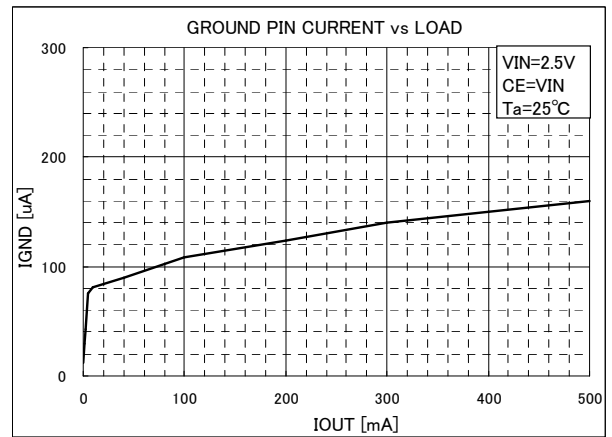

Figure 22.

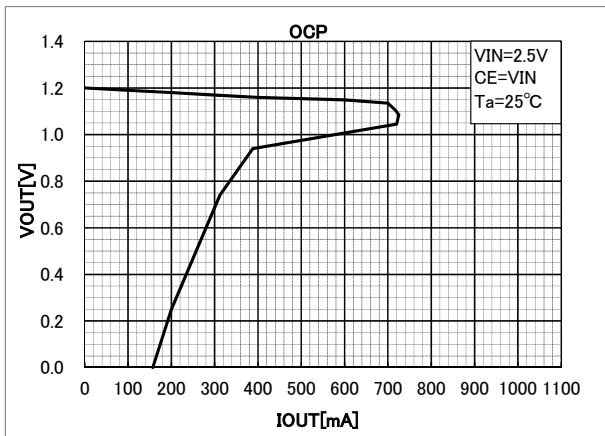

Figure 23.

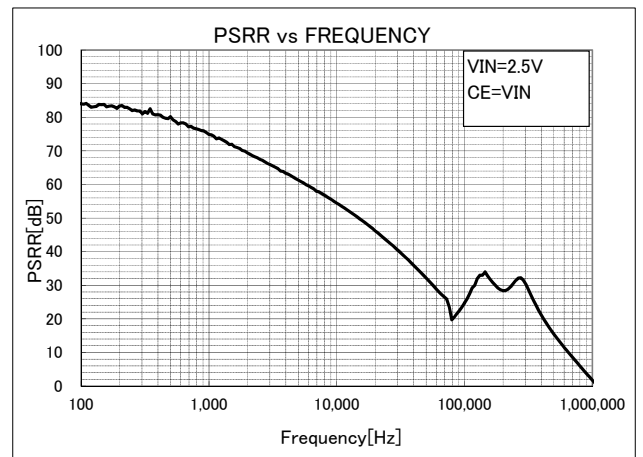

Figure 24.

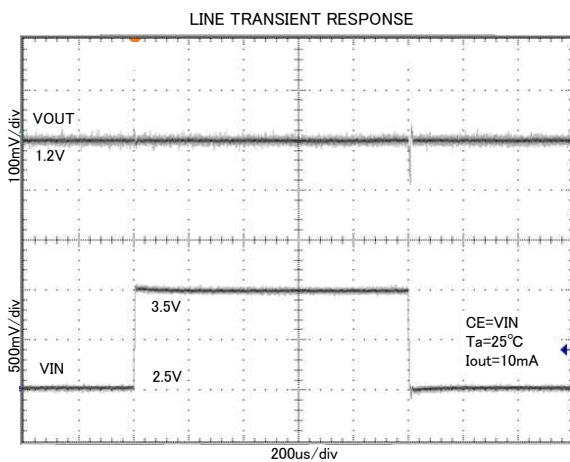

Figure 25.

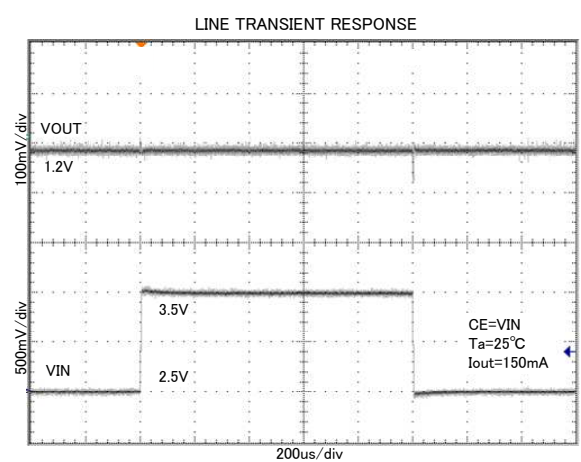

Figure 26.

Reference data BU12TH5WNVX-1 (Ta=25°C unless otherwise specified.)

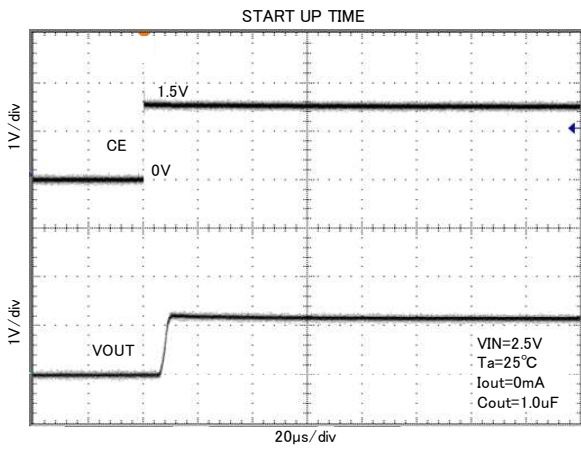

Figure 27.

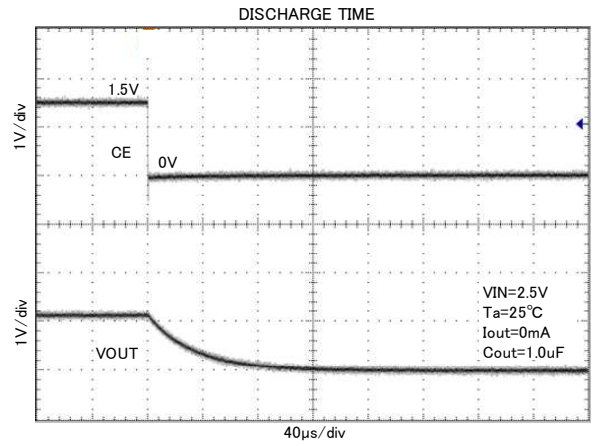

Figure 28.

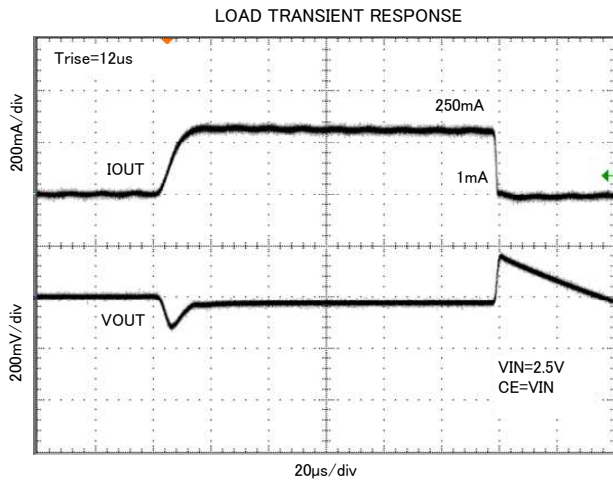

Figure 29.

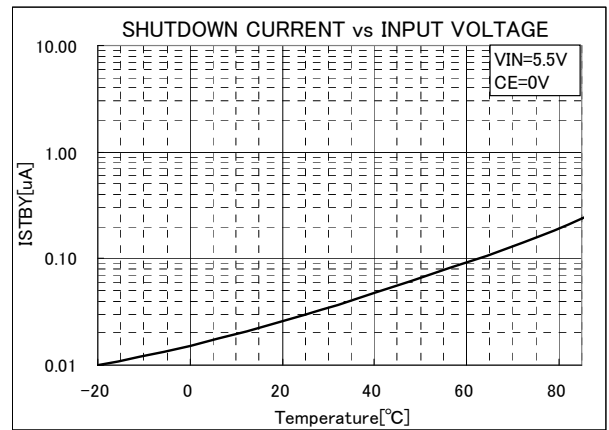

Figure 30.

Reference data BU2JTH5WNVX (Ta=25°C unless otherwise specified.)

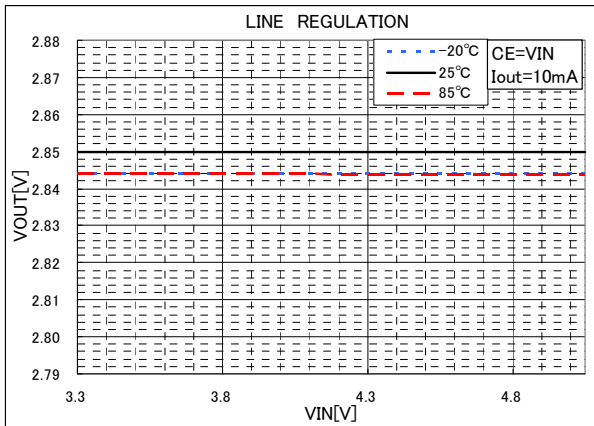

Figure 31.

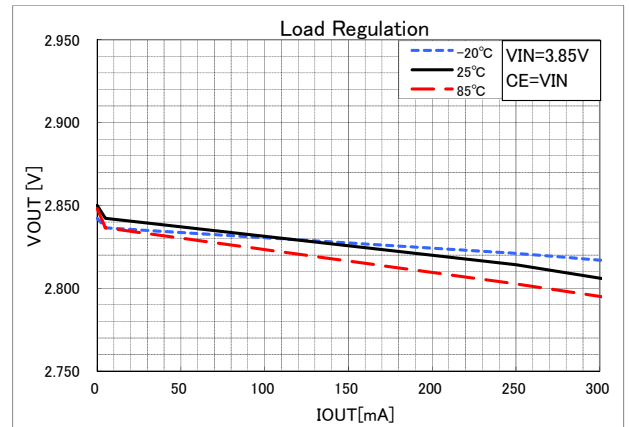

Figure 32.

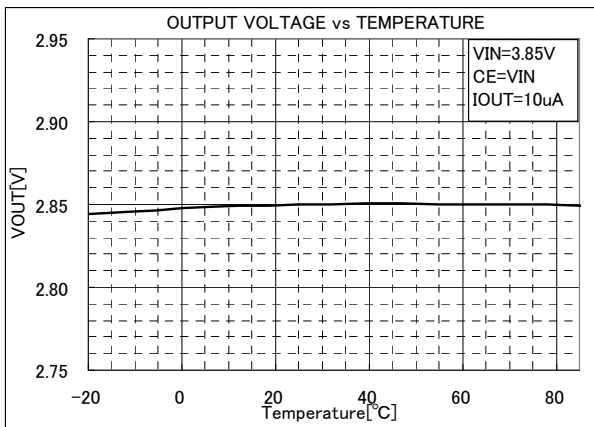

Figure 33.

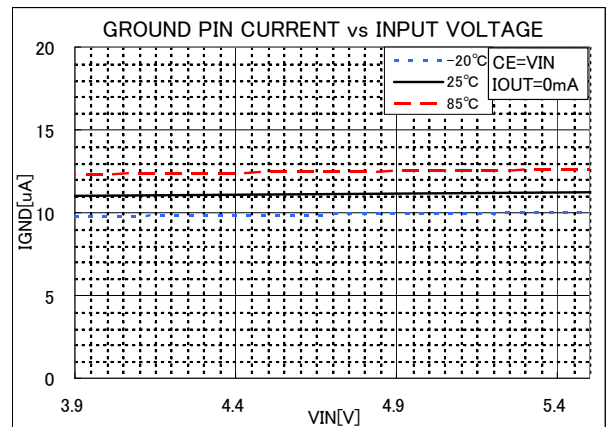

Figure 34.

Reference data BU2JTH5WNVX (Ta=25°C unless otherwise specified.)

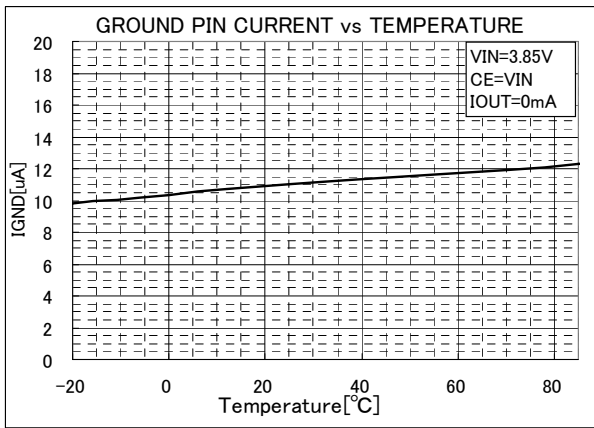

Figure 35.

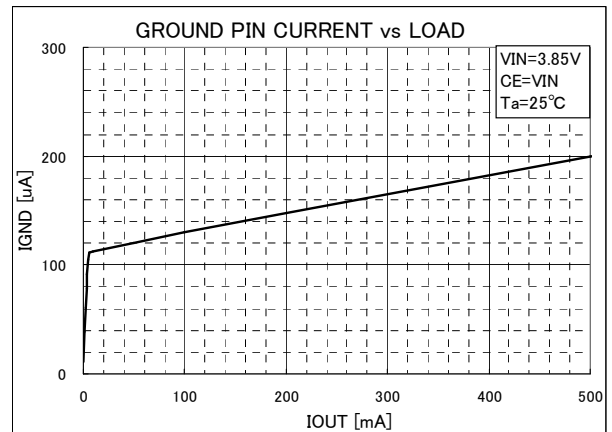

Figure 36.

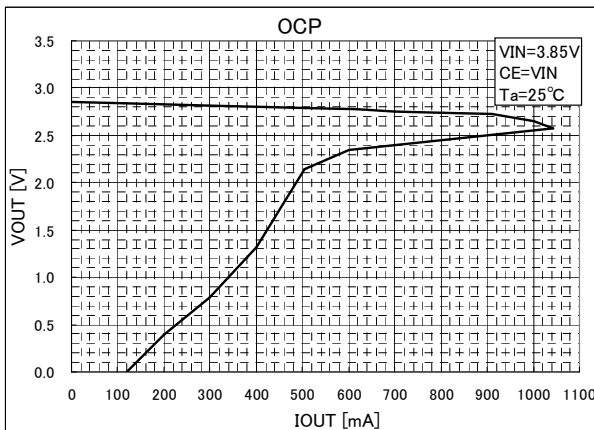

Figure 37.

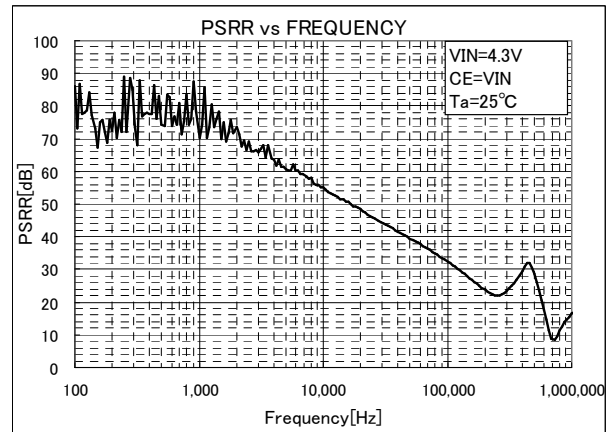

Figure 38.

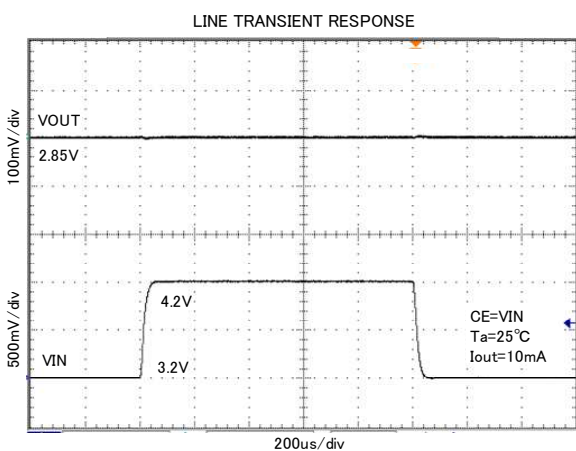

Figure 39.

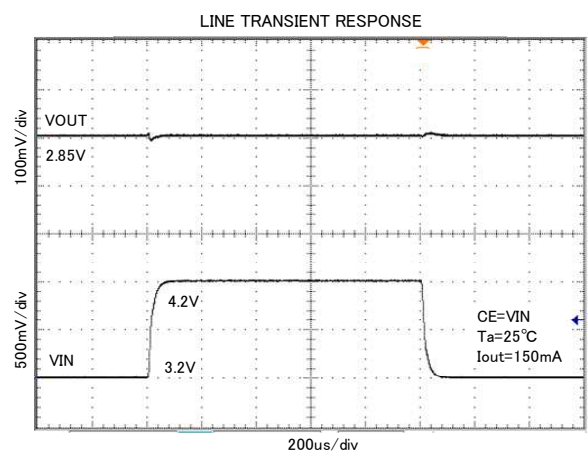

Figure 40.

Reference data BU2JTH5WNVX (Ta=25°C unless otherwise specified.)

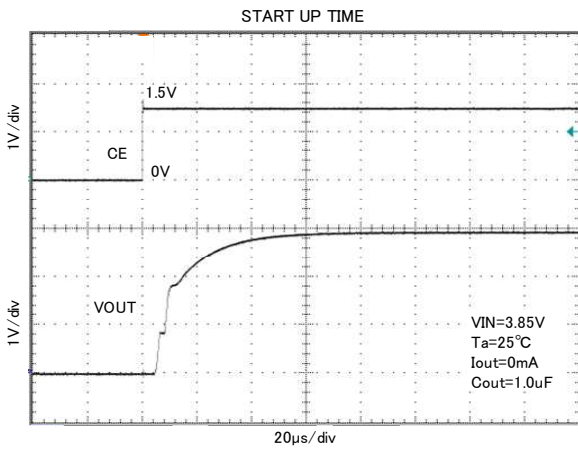

Figure 41.

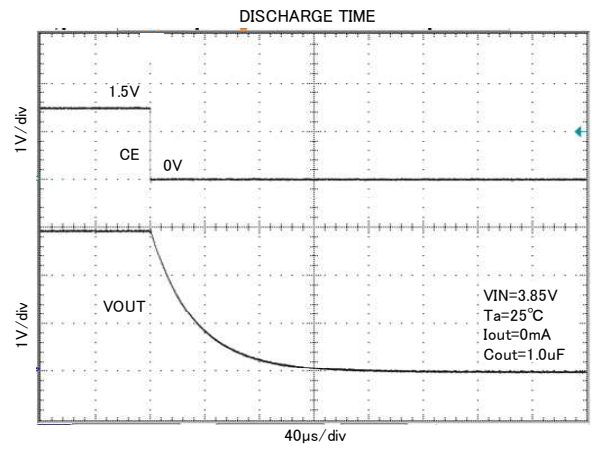

Figure 42.

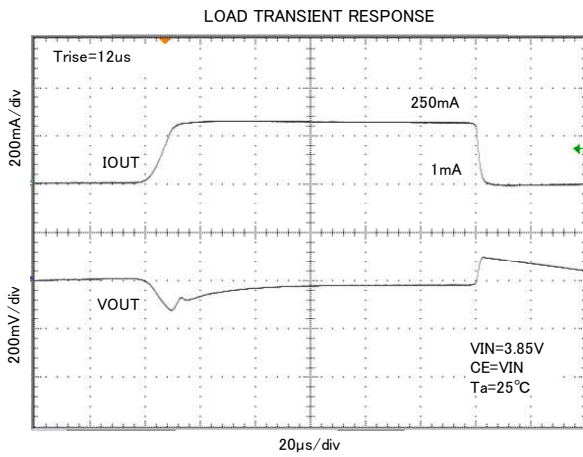

Figure 43.

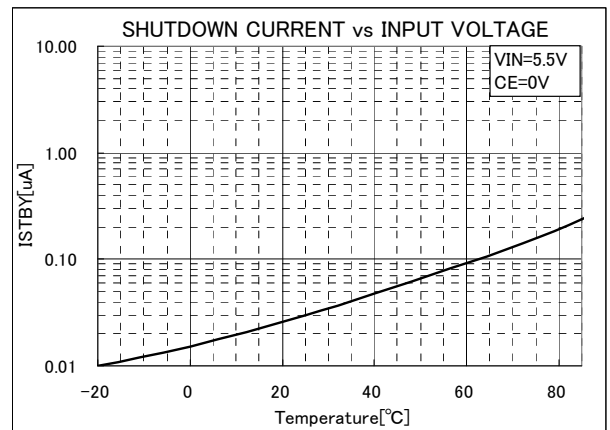

Figure 44.

Reference data BU35TH5WNVX (Ta=25°C unless otherwise specified.)

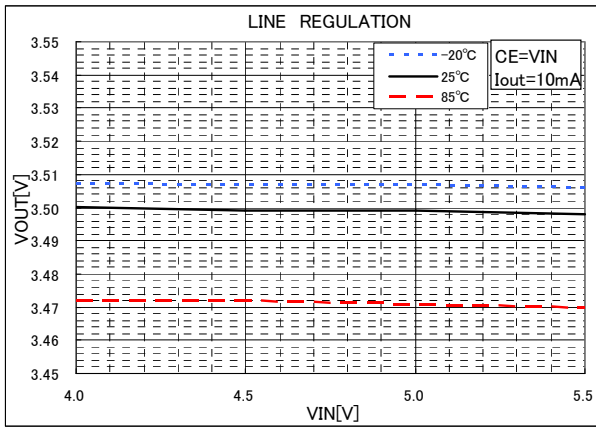

Figure 45.

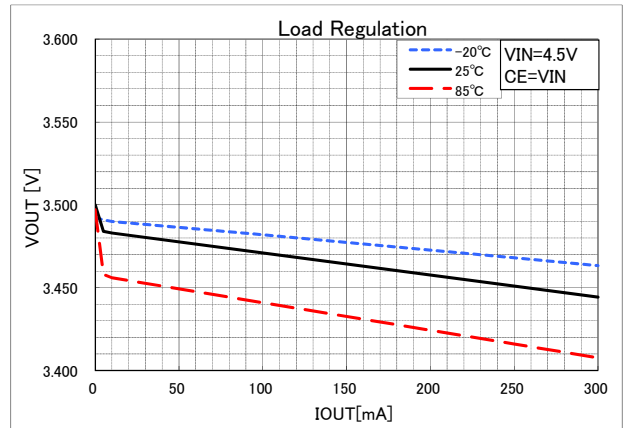

Figure 46.

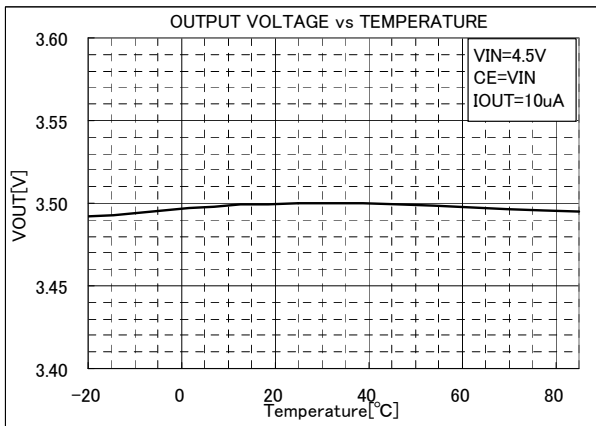

Figure 47.

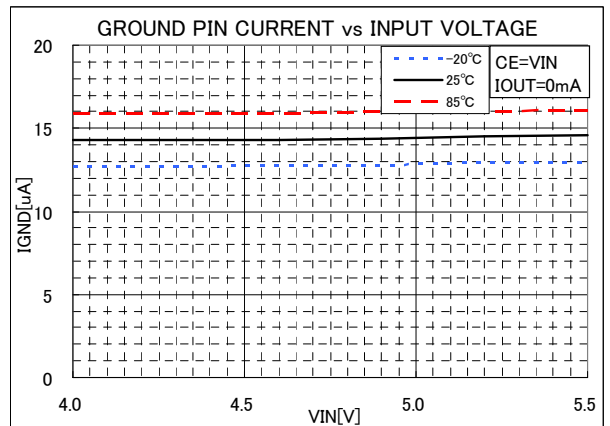

Figure 48.

Reference data BU35TH5WNVX (Ta=25°C unless otherwise specified.)

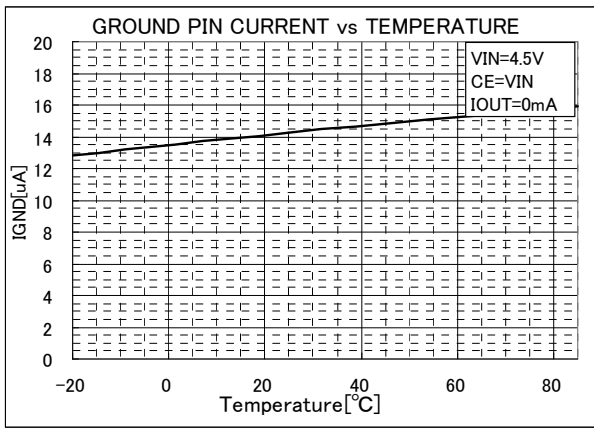

Figure 49.

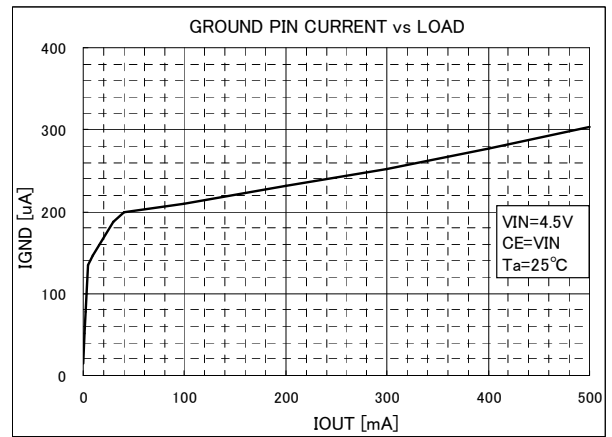

Figure 50.

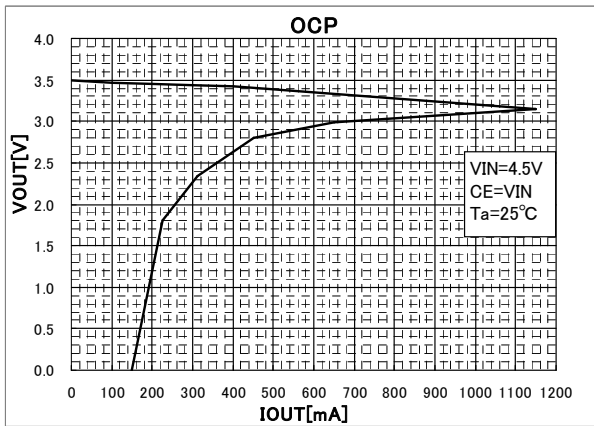

Figure 51.

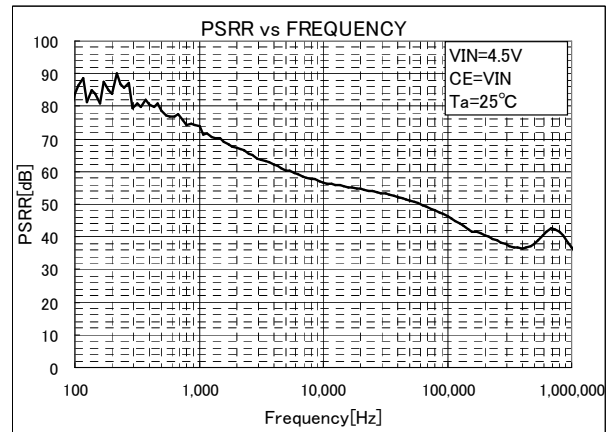

Figure 52.

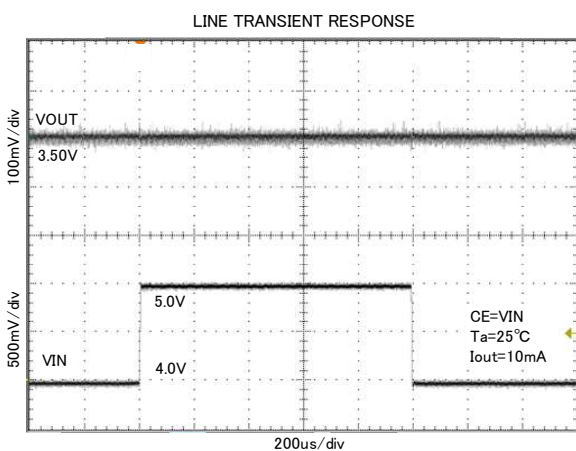

Figure 53.

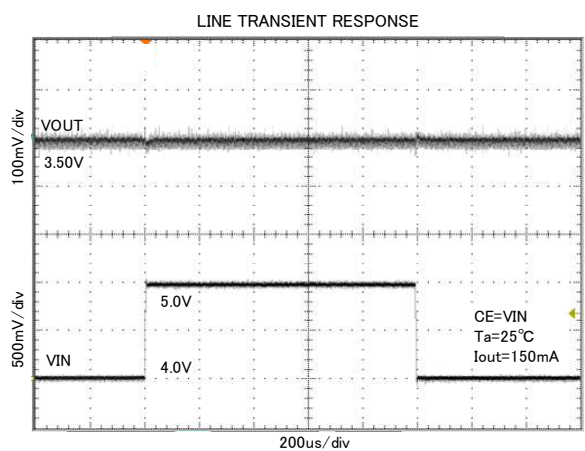

Figure 54.

Reference data BU35TH5WNVX (Ta=25°C unless otherwise specified.)

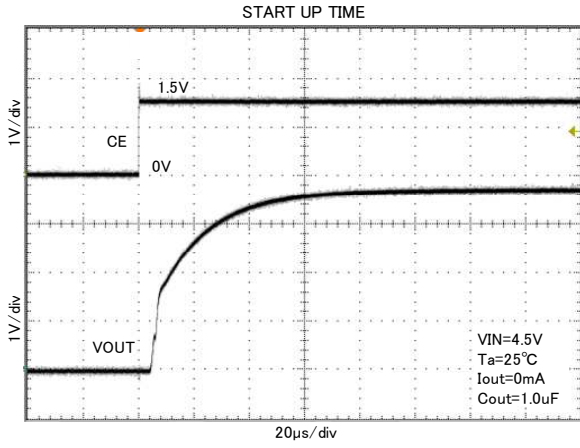

Figure 55.

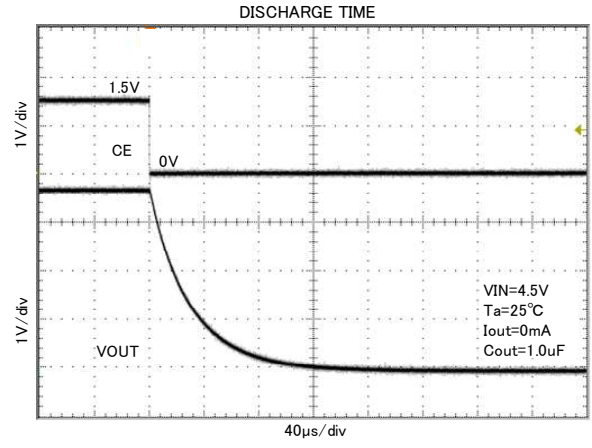

Figure 56.

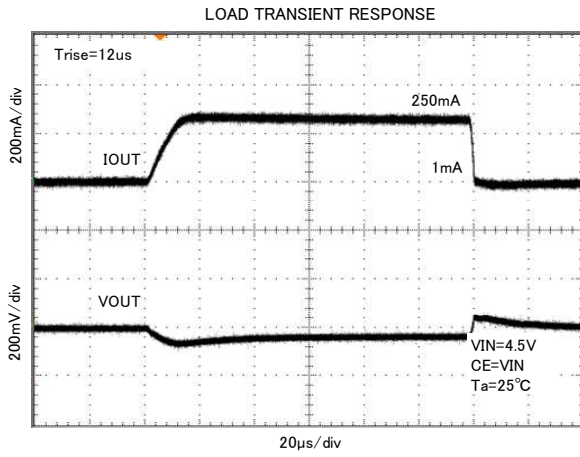

Figure 57.

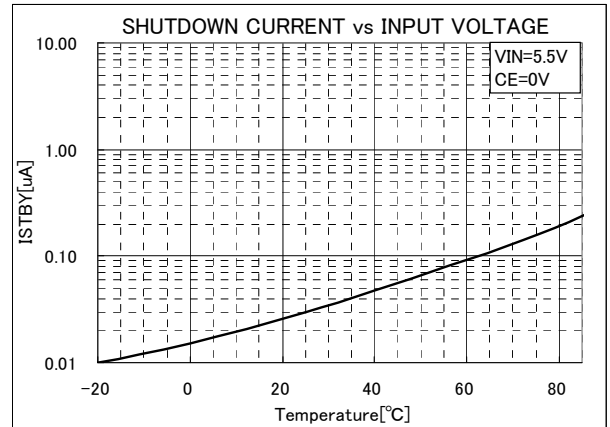

Figure 58.



**About power dissipation (Pd)**

As for power dissipation, an approximate estimate of the heat reduction characteristics and internal power consumption of IC are shown, so please use these for reference. Since power dissipation changes substantially depending on the implementation conditions (board size, board thickness, metal wiring rate, number of layers and through holes, etc.), it is recommended to measure Pd on a set board. Exceeding the power dissipation of IC may lead to deterioration of the original IC performance, such as reduction in current capability. Therefore, be sure to prepare sufficient margin within power dissipation for usage.

Calculation of the maximum internal power consumption of IC (P<sub>MAX</sub>)

$$P_{MAX} = (V_{IN} - V_{OUT}) \times I_{OUT(MAX)}$$

(V<sub>IN</sub>: Input voltage V<sub>OUT</sub>: Output voltage I<sub>OUT(MAX)</sub>: Maximum output current)

Measurement conditions

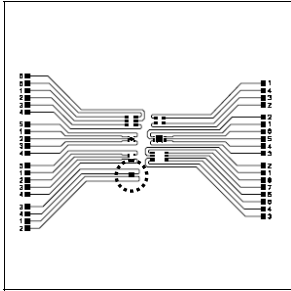
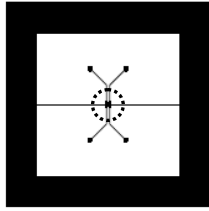
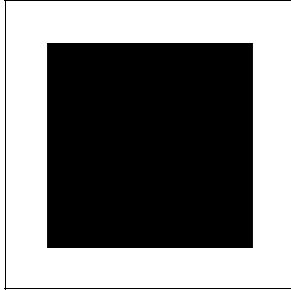
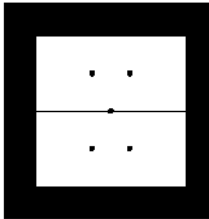
		Standard ROHM Board	Evaluation Board 1
Layout of Board for Measurement			
	IC Implementation Position		
Measurement State		With board implemented (Wind speed 0 m/s)	With board implemented (Wind speed 0 m/s)
Board Material		Glass epoxy resin (Double-side board)	Glass epoxy resin (Double-side board)
Board Size		70 mm x 70 mm x 1.6 mm	40 mm x 40 mm x 1.6 mm
Wiring Rate	Top layer	Metal (GND) wiring rate: Approx. 0%	Metal (GND) wiring rate: Approx. 50%
	Bottom layer	Metal (GND) wiring rate: Approx. 50%	Metal (GND) wiring rate: Approx. 50%
Through Hole		Diameter 0.5mm x 6 holes	Diameter 0.5mm x 25 holes
Power Dissipation		0.56W	0.39W
Thermal Resistance		$\theta_{ja} = 178.6^{\circ}\text{C/W}$	$\theta_{ja} = 256.4^{\circ}\text{C/W}$

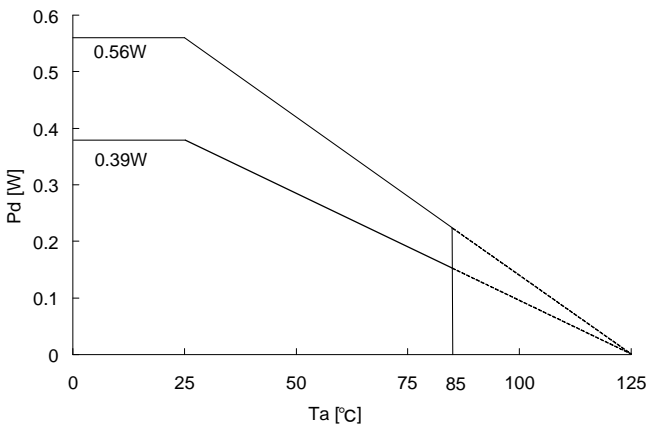

\* Please design the margin so that P<sub>MAX</sub> becomes is than Pd (P<sub>MAX</sub><Pd) within the usage temperature range

Figure 59. SSON004X1010 Power dissipation heat reduction characteristics (Reference)

## Operational Notes

### 1. Reverse Connection of Power Supply

Connecting the power supply in reverse polarity can damage the IC. Take precautions against reverse polarity when connecting the power supply, such as mounting an external diode between the power supply and the IC's power supply pins.

### 2. Power Supply Lines

Design the PCB layout pattern to provide low impedance supply lines. Separate the ground and supply lines of the digital and analog blocks to prevent noise in the ground and supply lines of the digital block from affecting the analog block. Furthermore, connect a capacitor to ground at all power supply pins. Consider the effect of temperature and aging on the capacitance value when using electrolytic capacitors.

### 3. Ground Voltage

Ensure that no pins are at a voltage below that of the ground pin at any time, even during transient condition.

### 4. Ground Wiring Pattern

When using both small-signal and large-current ground traces, the two ground traces should be routed separately but connected to a single ground at the reference point of the application board to avoid fluctuations in the small-signal ground caused by large currents. Also ensure that the ground traces of external components do not cause variations on the ground voltage. The ground lines must be as short and thick as possible to reduce line impedance.

### 5. Thermal Consideration

Should by any chance the power dissipation rating be exceeded the rise in temperature of the chip may result in deterioration of the properties of the chip. The absolute maximum rating of the Pd stated in this specification is when the IC is mounted on a 70mm x 70mm x 1.6mm glass epoxy board. In case of exceeding this absolute maximum rating, increase the board size and copper area to prevent exceeding the Pd rating.

### 6. Recommended Operating Conditions

These conditions represent a range within which the expected characteristics of the IC can be approximately obtained. The electrical characteristics are guaranteed under the conditions of each parameter.

### 7. Inrush Current

When power is first supplied to the IC, it is possible that the internal logic may be unstable and inrush current may flow instantaneously due to the internal powering sequence and delays, especially if the IC has more than one power supply. Therefore, give special consideration to power coupling capacitance, power wiring, width of ground wiring, and routing of connections.

### 8. Operation Under Strong Electromagnetic Field

Operating the IC in the presence of a strong electromagnetic field may cause the IC to malfunction.

### 9. Testing on Application Boards

When testing the IC on an application board, connecting a capacitor directly to a low-impedance output pin may subject the IC to stress. Always discharge capacitors completely after each process or step. The IC's power supply should always be turned off completely before connecting or removing it from the test setup during the inspection process. To prevent damage from static discharge, ground the IC during assembly and use similar precautions during transport and storage.

### 10. Inter-pin Short and Mounting Errors

Ensure that the direction and position are correct when mounting the IC on the PCB. Incorrect mounting may result in damaging the IC. Avoid nearby pins being shorted to each other especially to ground, power supply and output pin. Inter-pin shorts could be due to many reasons such as metal particles, water droplets (in very humid environment) and unintentional solder bridge deposited in between pins during assembly to name a few.

**Operational Notes – continued****11. Unused Input Pins**

Input pins of an IC are often connected to the gate of a MOS transistor. The gate has extremely high impedance and extremely low capacitance. If left unconnected, the electric field from the outside can easily charge it. The small charge acquired in this way is enough to produce a significant effect on the conduction through the transistor and cause unexpected operation of the IC. So unless otherwise specified, unused input pins should be connected to the power supply or ground line.

**12. Regarding the Input Pin of the IC**

In the construction of this IC, P-N junctions are inevitably formed creating parasitic diodes or transistors. The operation of these parasitic elements can result in mutual interference among circuits, operational faults, or physical damage. Therefore, conditions which cause these parasitic elements to operate, such as applying a voltage to an input pin lower than the ground voltage should be avoided. Furthermore, do not apply a voltage to the input pins when no power supply voltage is applied to the IC. Even if the power supply voltage is applied, make sure that the input pins have voltages within the values specified in the electrical characteristics of this IC.

**13. Voltage of CE pin**

To enable standby mode for all channels, set the CE pin to 0.3 V or less, and for normal operation, to 1.2 V or more. Setting CE to a voltage between 0.3 and 1.2 V may cause malfunction and should be avoided. Keep transition time between high and low (or vice versa) to a minimum.

Additionally, if CE is shorted to VIN, the IC will switch to standby mode and disable the output discharge circuit, causing a temporary voltage to remain on the output pin. If the IC is switched on again while this voltage is present, overshoot may occur on the output. Therefore, in applications where these pins are shorted, the output should always be completely discharged before turning the IC on.

**14. Ceramic Capacitor**

When using a ceramic capacitor, determine the dielectric constant considering the change of capacitance with temperature and the decrease in nominal capacitance due to DC bias and others.

**15. Area of Safe Operation (ASO)**

Operate the IC such that the output voltage, output current, and power dissipation are all within the Area of Safe Operation (ASO).

**16. Over Current Protection Circuit (OCP)**

This IC incorporates an integrated overcurrent protection circuit that is activated when the load is shorted. This protection circuit is effective in preventing damage due to sudden and unexpected incidents. However, the IC should not be used in applications characterized by continuous operation or transitioning of the protection circuit.

**Revision History**

Date	Revision	Changes
27.Mar.2014	001	New Release.
27.May.2014	002	Adding a lineup. Reference data LOAD REGULATION extension of IOOUT. CE Pin Control Voltage is changed.
4.Nov.2015	003	Adding chip Rev2 to line up of P2.
14.Dec.2015	004	Adding evaluation result of BU1ATH5WNVX-1 and BU12TH5WNVX-1.

# Notice

## Precaution on using ROHM Products

- Our Products are designed and manufactured for application in ordinary electronic equipments (such as AV equipment, OA equipment, telecommunication equipment, home electronic appliances, amusement equipment, etc.). If you intend to use our Products in devices requiring extremely high reliability (such as medical equipment <sup>(Note 1)</sup>, transport equipment, traffic equipment, aircraft/spacecraft, nuclear power controllers, fuel controllers, car equipment including car accessories, safety devices, etc.) and whose malfunction or failure may cause loss of human life, bodily injury or serious damage to property ("Specific Applications"), please consult with the ROHM sales representative in advance. Unless otherwise agreed in writing by ROHM in advance, ROHM shall not be in any way responsible or liable for any damages, expenses or losses incurred by you or third parties arising from the use of any ROHM's Products for Specific Applications.

(Note1) Medical Equipment Classification of the Specific Applications

JAPAN	USA	EU	CHINA
CLASS III	CLASS III	CLASS II b	CLASS III
CLASS IV		CLASS III	

- ROHM designs and manufactures its Products subject to strict quality control system. However, semiconductor products can fail or malfunction at a certain rate. Please be sure to implement, at your own responsibilities, adequate safety measures including but not limited to fail-safe design against the physical injury, damage to any property, which a failure or malfunction of our Products may cause. The following are examples of safety measures:
  - Installation of protection circuits or other protective devices to improve system safety
  - Installation of redundant circuits to reduce the impact of single or multiple circuit failure
- Our Products are designed and manufactured for use under standard conditions and not under any special or extraordinary environments or conditions, as exemplified below. Accordingly, ROHM shall not be in any way responsible or liable for any damages, expenses or losses arising from the use of any ROHM's Products under any special or extraordinary environments or conditions. If you intend to use our Products under any special or extraordinary environments or conditions (as exemplified below), your independent verification and confirmation of product performance, reliability, etc. prior to use, must be necessary:
  - Use of our Products in any types of liquid, including water, oils, chemicals, and organic solvents
  - Use of our Products outdoors or in places where the Products are exposed to direct sunlight or dust
  - Use of our Products in places where the Products are exposed to sea wind or corrosive gases, including Cl<sub>2</sub>, H<sub>2</sub>S, NH<sub>3</sub>, SO<sub>2</sub>, and NO<sub>2</sub>
  - Use of our Products in places where the Products are exposed to static electricity or electromagnetic waves
  - Use of our Products in proximity to heat-producing components, plastic cords, or other flammable items
  - Sealing or coating our Products with resin or other coating materials
  - Use of our Products without cleaning residue of flux (even if you use no-clean type fluxes, cleaning residue of flux is recommended); or Washing our Products by using water or water-soluble cleaning agents for cleaning residue after soldering
  - Use of the Products in places subject to dew condensation
- The Products are not subject to radiation-proof design.
- Please verify and confirm characteristics of the final or mounted products in using the Products.
- In particular, if a transient load (a large amount of load applied in a short period of time, such as pulse. is applied, confirmation of performance characteristics after on-board mounting is strongly recommended. Avoid applying power exceeding normal rated power; exceeding the power rating under steady-state loading condition may negatively affect product performance and reliability.
- De-rate Power Dissipation depending on ambient temperature. When used in sealed area, confirm that it is the use in the range that does not exceed the maximum junction temperature.
- Confirm that operation temperature is within the specified range described in the product specification.
- ROHM shall not be in any way responsible or liable for failure induced under deviant condition from what is defined in this document.

## Precaution for Mounting / Circuit board design

- When a highly active halogenous (chlorine, bromine, etc.) flux is used, the residue of flux may negatively affect product performance and reliability.
- In principle, the reflow soldering method must be used on a surface-mount products, the flow soldering method must be used on a through hole mount products. If the flow soldering method is preferred on a surface-mount products, please consult with the ROHM representative in advance.

For details, please refer to ROHM Mounting specification

**Precautions Regarding Application Examples and External Circuits**

1. If change is made to the constant of an external circuit, please allow a sufficient margin considering variations of the characteristics of the Products and external components, including transient characteristics, as well as static characteristics.
2. You agree that application notes, reference designs, and associated data and information contained in this document are presented only as guidance for Products use. Therefore, in case you use such information, you are solely responsible for it and you must exercise your own independent verification and judgment in the use of such information contained in this document. ROHM shall not be in any way responsible or liable for any damages, expenses or losses incurred by you or third parties arising from the use of such information.

**Precaution for Electrostatic**

This Product is electrostatic sensitive product, which may be damaged due to electrostatic discharge. Please take proper caution in your manufacturing process and storage so that voltage exceeding the Products maximum rating will not be applied to Products. Please take special care under dry condition (e.g. Grounding of human body / equipment / solder iron, isolation from charged objects, setting of Ionizer, friction prevention and temperature / humidity control).

**Precaution for Storage / Transportation**

1. Product performance and soldered connections may deteriorate if the Products are stored in the places where:
  - [a] the Products are exposed to sea winds or corrosive gases, including Cl<sub>2</sub>, H<sub>2</sub>S, NH<sub>3</sub>, SO<sub>2</sub>, and NO<sub>2</sub>
  - [b] the temperature or humidity exceeds those recommended by ROHM
  - [c] the Products are exposed to direct sunshine or condensation
  - [d] the Products are exposed to high Electrostatic
2. Even under ROHM recommended storage condition, solderability of products out of recommended storage time period may be degraded. It is strongly recommended to confirm solderability before using Products of which storage time is exceeding the recommended storage time period.
3. Store / transport cartons in the correct direction, which is indicated on a carton with a symbol. Otherwise bent leads may occur due to excessive stress applied when dropping of a carton.
4. Use Products within the specified time after opening a humidity barrier bag. Baking is required before using Products of which storage time is exceeding the recommended storage time period.

**Precaution for Product Label**

QR code printed on ROHM Products label is for ROHM's internal use only.

**Precaution for Disposition**

When disposing Products please dispose them properly using an authorized industry waste company.

**Precaution for Foreign Exchange and Foreign Trade act**

Since concerned goods might be fallen under listed items of export control prescribed by Foreign exchange and Foreign trade act, please consult with ROHM in case of export.

**Precaution Regarding Intellectual Property Rights**

1. All information and data including but not limited to application example contained in this document is for reference only. ROHM does not warrant that foregoing information or data will not infringe any intellectual property rights or any other rights of any third party regarding such information or data.
2. ROHM shall not have any obligations where the claims, actions or demands arising from the combination of the Products with other articles such as components, circuits, systems or external equipment (including software).
3. No license, expressly or implied, is granted hereby under any intellectual property rights or other rights of ROHM or any third parties with respect to the Products or the information contained in this document. Provided, however, that ROHM will not assert its intellectual property rights or other rights against you or your customers to the extent necessary to manufacture or sell products containing the Products, subject to the terms and conditions herein.

**Other Precaution**

1. This document may not be reprinted or reproduced, in whole or in part, without prior written consent of ROHM.
2. The Products may not be disassembled, converted, modified, reproduced or otherwise changed without prior written consent of ROHM.
3. In no event shall you use in any way whatsoever the Products and the related technical information contained in the Products or this document for any military purposes, including but not limited to, the development of mass-destruction weapons.
4. The proper names of companies or products described in this document are trademarks or registered trademarks of ROHM, its affiliated companies or third parties.

**General Precaution**

1. Before you use our Products, you are requested to carefully read this document and fully understand its contents. ROHM shall not be in any way responsible or liable for failure, malfunction or accident arising from the use of any ROHM's Products against warning, caution or note contained in this document.
2. All information contained in this document is current as of the issuing date and subject to change without any prior notice. Before purchasing or using ROHM's Products, please confirm the latest information with a ROHM sales representative.
3. The information contained in this document is provided on an "as is" basis and ROHM does not warrant that all information contained in this document is accurate and/or error-free. ROHM shall not be in any way responsible or liable for any damages, expenses or losses incurred by you or third parties resulting from inaccuracy or errors of or concerning such information.