

RFCA3828

75Ω High Linearity pHEMT MMIC Amplifier

The RFCA3828 is a high performance pHEMT MMIC amplifier designed to run from a single 5V or 6V supply, without the need for an external dropping resistor. The high gain, high linearity, and low distortion from 50MHz to 1200MHz make this part ideal for broad-band cable applications. An integrated active bias circuit provides stable gain over temperature and process variations. It is offered in a small SOT-89 package and is RoHS compliant.

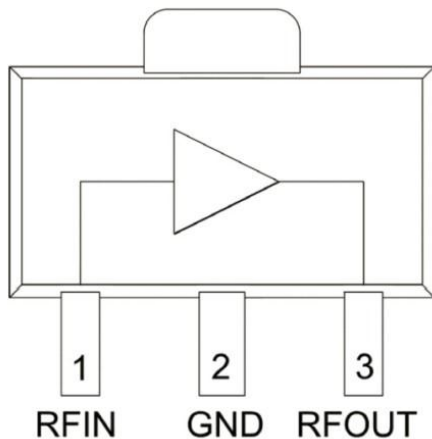

Functional Block Diagram



Package: SOT-89

Features

- High Gain = 22dB
- High Linearity and Low Distortion
 - 39dBm OIP3 at 500MHz
 - -68dBc CSO, 79ch, +30dBmV/ch
 - -82dBc CTB, 79ch, +30dBmV/ch
- Single 5V or 6V Supply
- Noise Figure = 1.54dB at 500MHz

Applications

- Broadband 75Ω Gain Block
- CATV Distribution Amplifiers
- Pre-amplifier for CATV Multi-Dwelling Units

Ordering Information

RFCA3828SQ	Sample bag with 25 pieces
RFCA3828SR	7" Reel with 100 pieces
RFCA3828TR13	13" Reel with 2500 pieces
RFCA3828PCK-410	50MHz to 1200MHz PCBA with 5-piece sample bag

Absolute Maximum Ratings

Parameter	Rating	Unit
Max Device Current (I_{DD})	250	mA
Max Device Voltage (V_{DD})	7	V
Max CW RF Input Power	24	dBm
Storage Temperature	-40 to +150	°C
ESD Rating (HBM)	250 (Class 1A)	V
Moisture Sensitivity Level	MSL2	



Caution! ESD sensitive device.



RFMD Green: RoHS status based on EU Directive 2011/65/EU (at time of this document revision), halogen free per IEC 61249-2-21, < 1000ppm each of antimony trioxide in polymeric materials and red phosphorus as a flame retardant, and <2% antimony in solder.

Exceeding any one or a combination of the Absolute Maximum Rating conditions may cause permanent damage to the device. Extended application of Absolute Maximum Rating conditions to the device may reduce device reliability. Specified typical performance or functional operation of the device under Absolute Maximum Rating conditions is not implied.

Recommended Operating Condition

Parameter	Specification			Unit
	Min	Typ	Max	
Operating Temperature Range	-40		+85	°C
Operating Junction Temperature			160	°C
Supply Voltage Range ^{1,2}	5.7	6	6.3	V
Supply Voltage Range ^{1,2}	4.75	5	5.25	V

Notes:

- Operation of this device beyond any one of these limits may cause permanent damage. For reliable continuous operation, the device voltage and current must not exceed the maximum operating values specified in the Absolute Maximum Ratings Table above.
- Bias conditions should also satisfy the following expression: $I_{DD} < (T_C - T_L) / R_{TH, j-l}$ and $T_L = T_{LEAD}$

Nominal Operating Parameters

Parameter	Specification			Unit	Condition
	Min	Typ	Max		
					$V_{DD} = 6V, I_{DD} = 169mA, T_L = 25°C, Z_S = Z_L = 75\Omega$
Frequency Range	50		1200	MHz	
Small Signal Gain		22		dB	50MHz
		22		dB	500MHz
		20.5		dB	1000MHz
		20.5		dB	1200MHz
Gain Flatness		1.5		dB	1000MHz
		2.0		dB	1200MHz
P1dB		22.5		dBm	500MHz
Noise Figure		1.54		dB	
Input Return Loss		-16		dB	50MHz
		-18		dB	500MHz

Parameter	Specification			Unit	Condition
	Min	Typ	Max		
Continued					$V_{DD} = 6V, I_{DD} = 169mA, T_L = 25^{\circ}C, Z_S = Z_L = 75\Omega$
Input Return Loss		-13.5		dB	1000MHz
		-13.5		dB	1200MHz
Output Return Loss		-23		dB	50MHz
		-20		dB	500MHz
Output Return Loss		-14.5		dB	1000MHz
		-16		dB	1200MHz
Output IP3		43		dBm	50MHz, Tone Spacing = 6MHz, P _{OUT} per tone = +7dBm
		39		dBm	500MHz, Tone Spacing = 6MHz, P _{OUT} per tone = +7dBm
		37		dBm	1000MHz, Tone Spacing = 6MHz, P _{OUT} per tone = +7dBm
		36		dBm	1200MHz, Tone Spacing = 6MHz, P _{OUT} per tone = +7dBm
Output IP2		67		dBm	50MHz, Tone Spacing = 30MHz, P _{OUT} per tone = +3dBm
		55		dBm	500MHz, Tone Spacing = 30MHz, P _{OUT} per tone = +3dBm
		52		dBm	1000MHz, Tone Spacing = 30MHz, P _{OUT} per tone = +3dBm
		52		dBm	1200MHz, Tone Spacing = 30MHz, P _{OUT} per tone = +3dBm
CSO		-68		dBc	79 Channels, +30dBmV/ch output
CTB		-82		dBc	
XMOD		-77		dBc	
Device Operating Current (I _{DD})		169		mA	
Thermal Resistance (R _{TH})		54		°C/W	Junction to backside of PCB

Typical Application Schematic 50MHz to 1200MHz

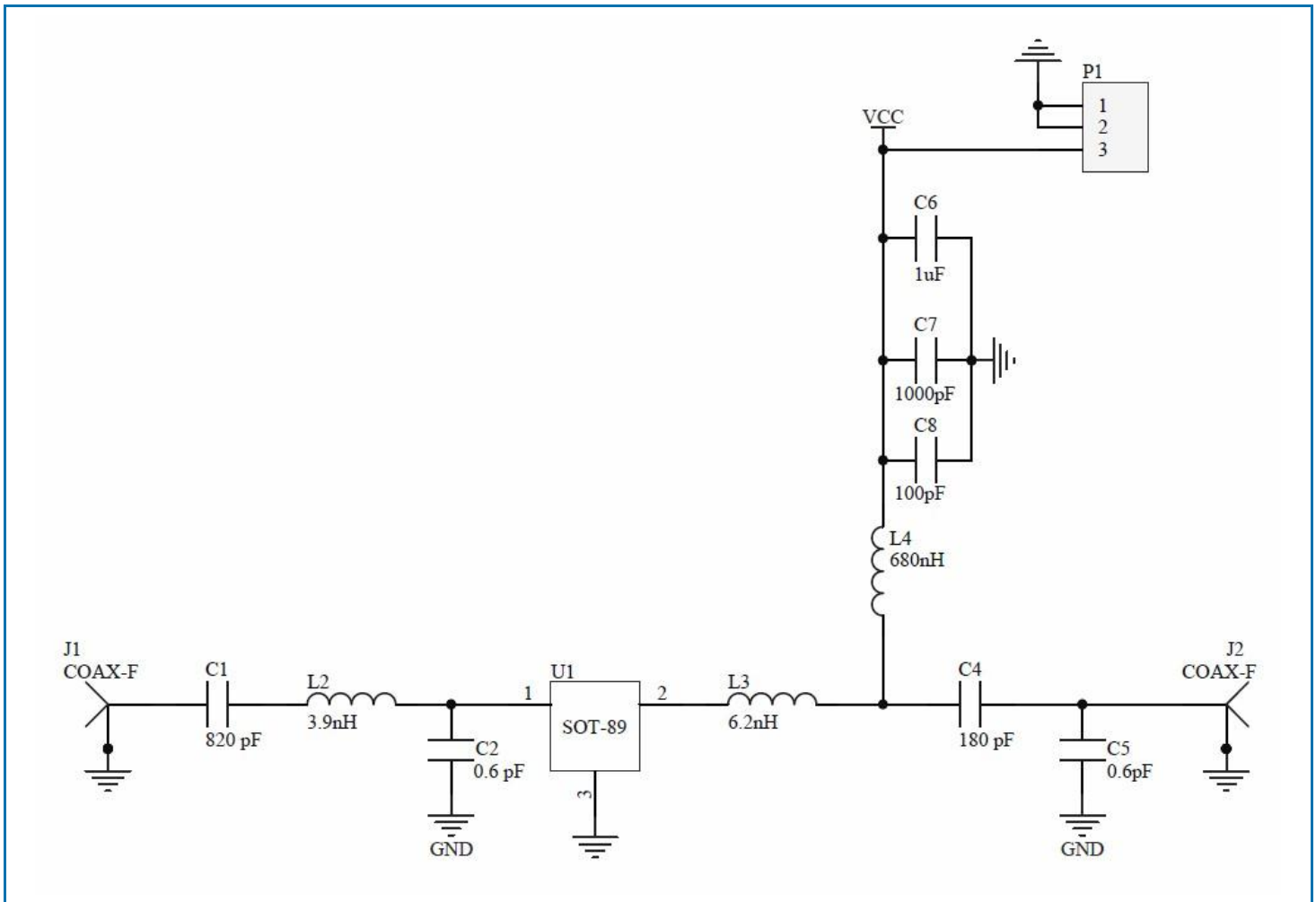

Typical Performance: $V_{DD} = 6V$, $T_L = 25^{\circ}C$, $Z_S = Z_L = 75\Omega$

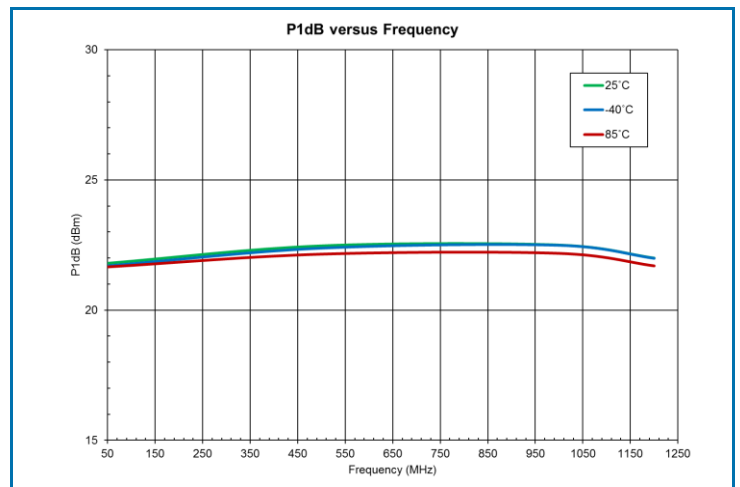
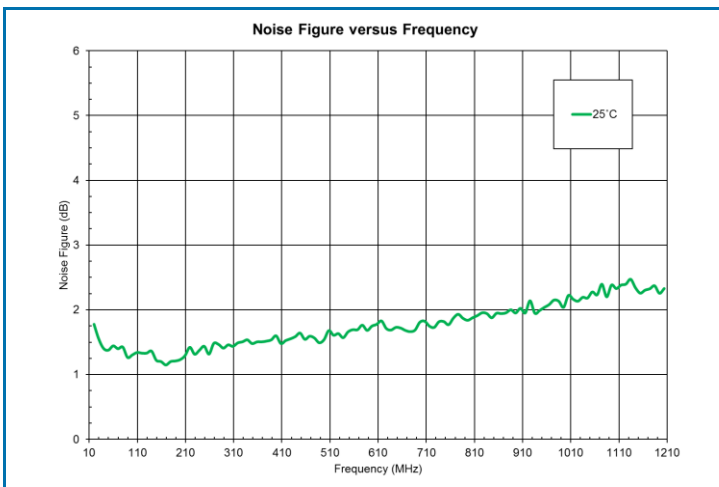
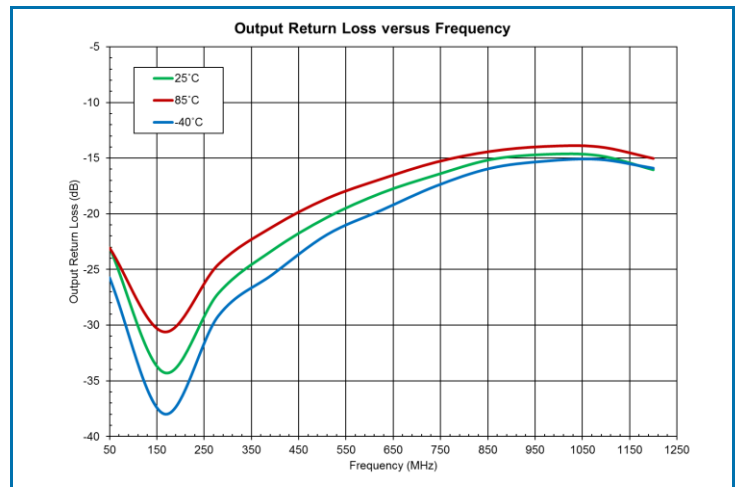
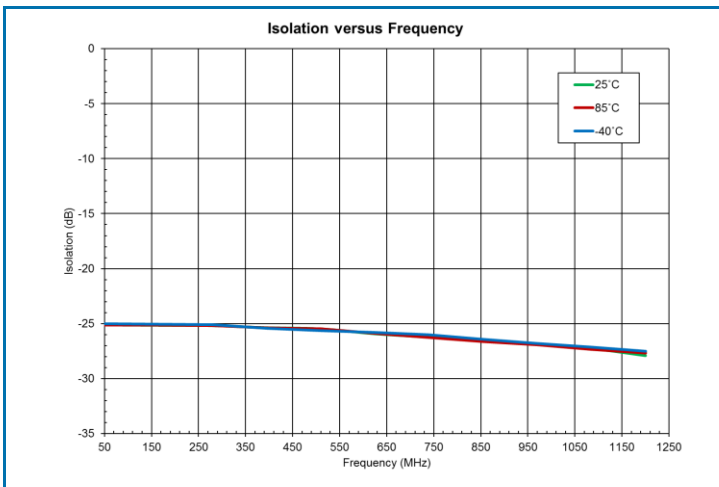
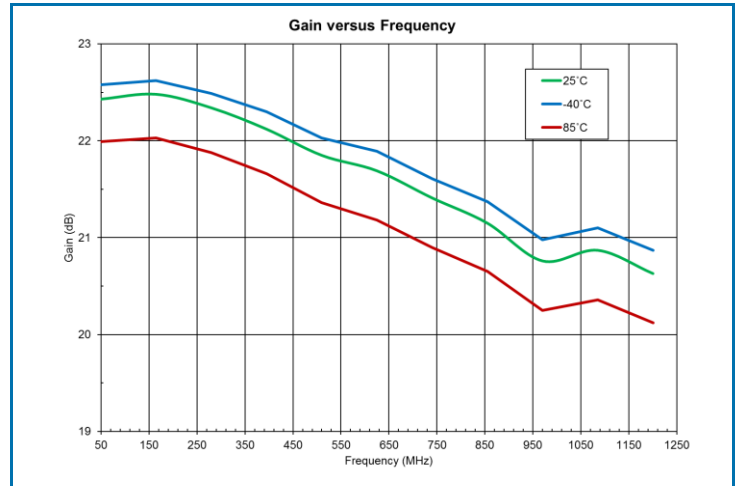
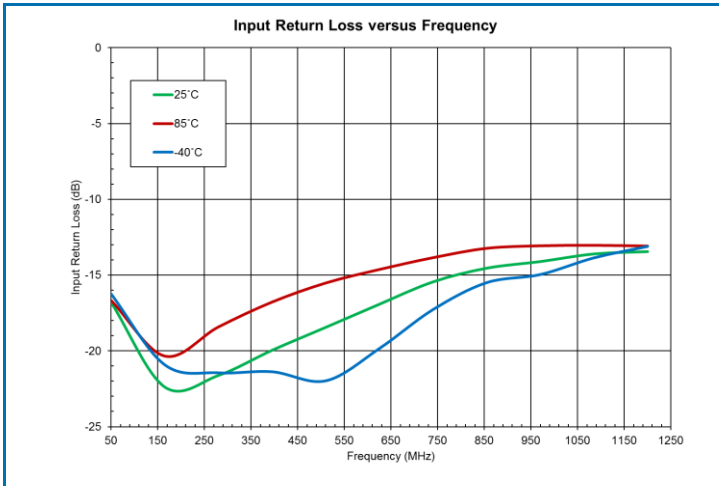

Typical Performance: $V_{DD} = 6V$, $T_L = 25^\circ C$, $Z_S = Z_L = 75\Omega$

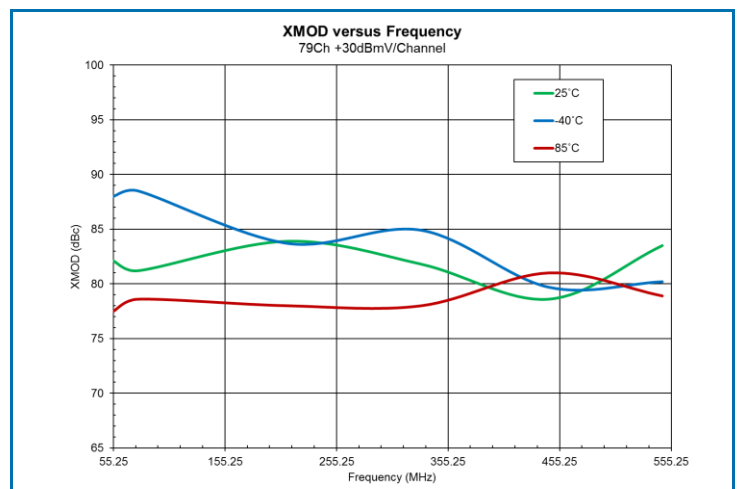
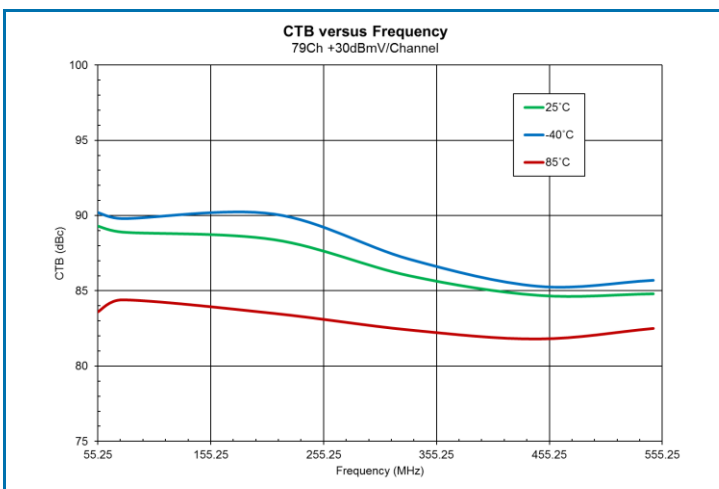
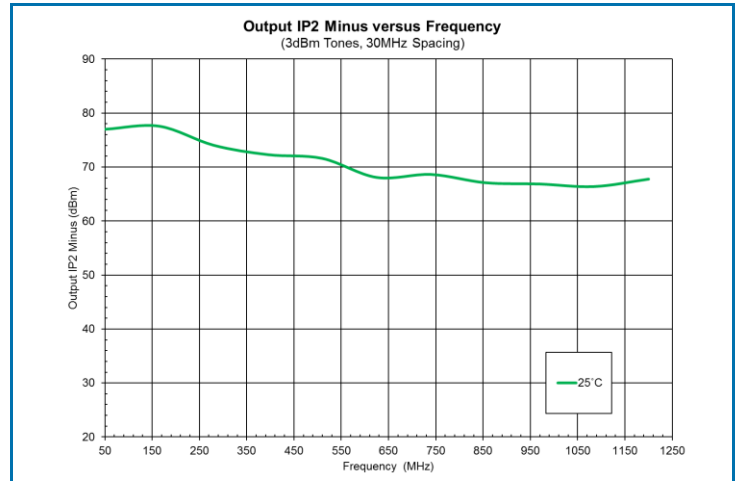
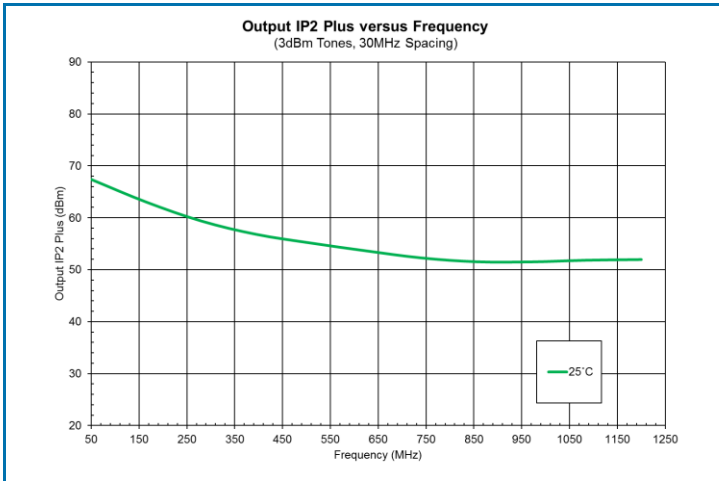
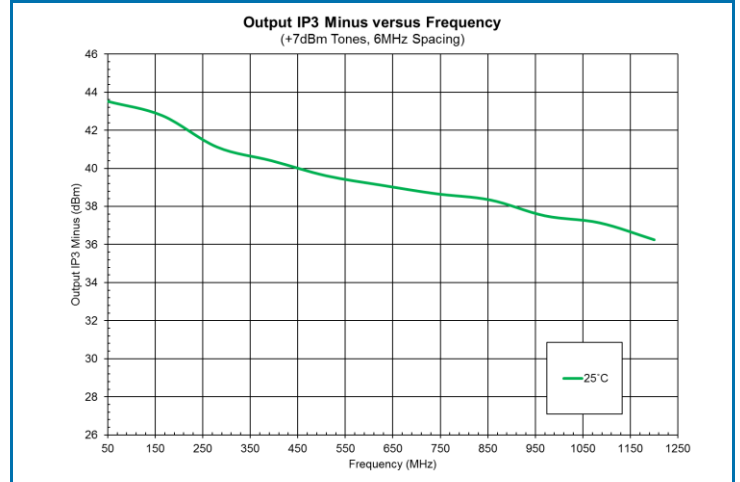
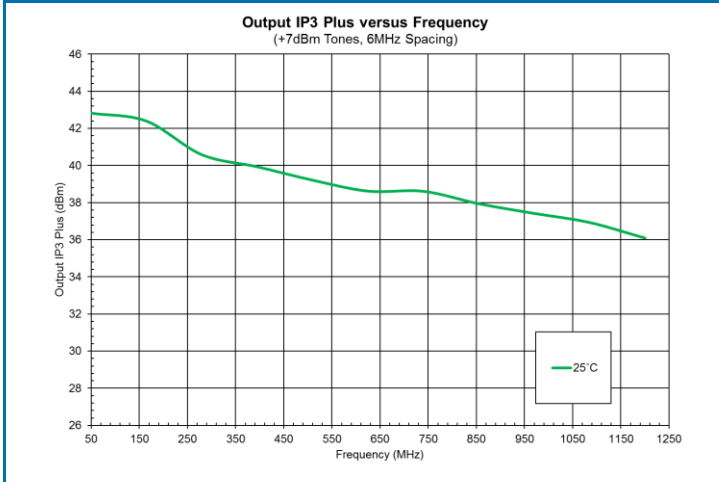

Typical Performance: $V_{DD} = 6V$, $T_L = 25^{\circ}C$, $Z_S = Z_L = 75\Omega$

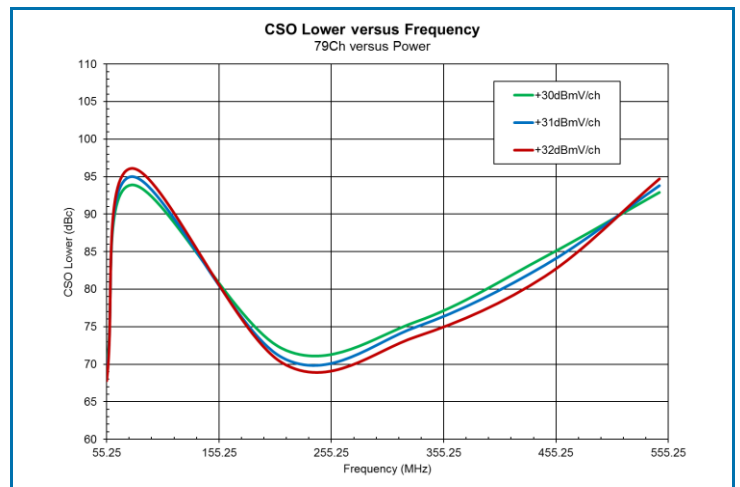
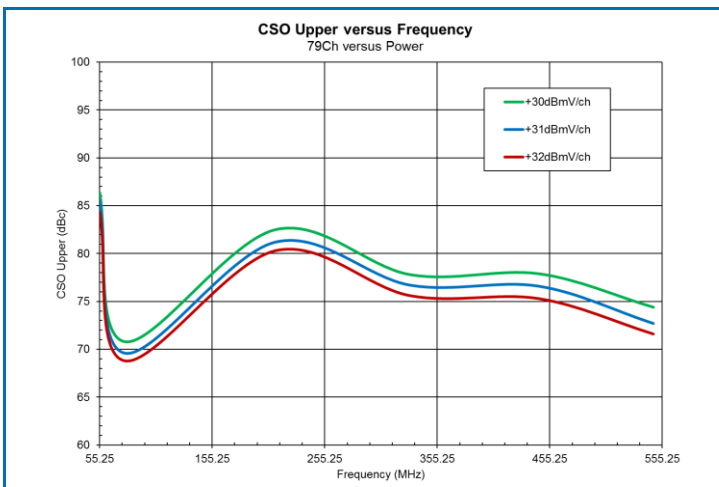
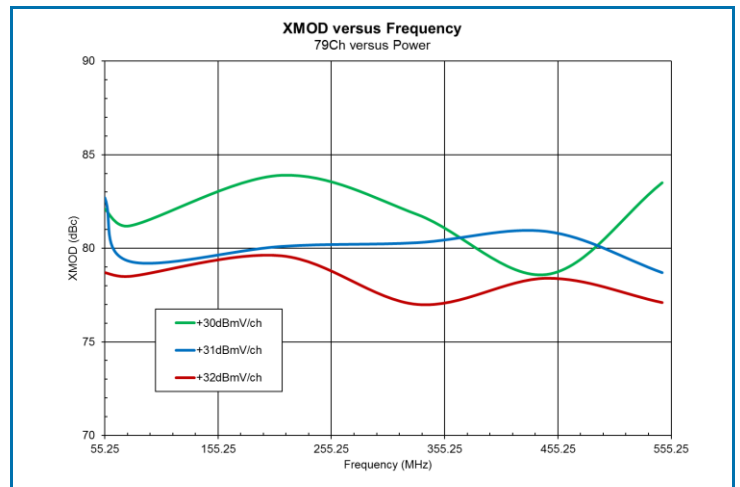
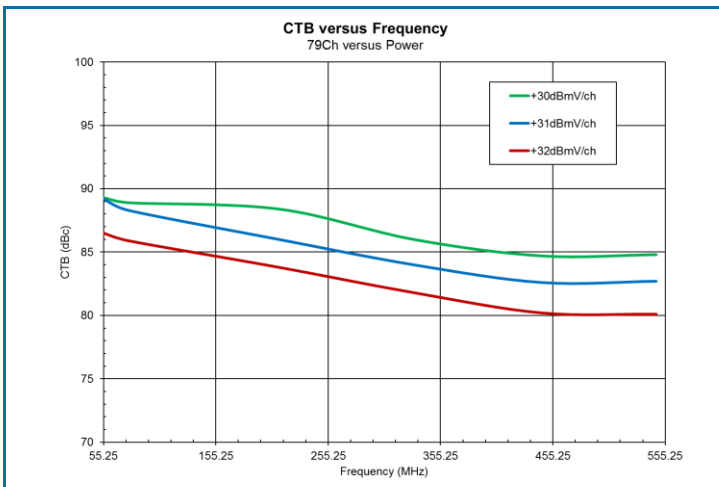
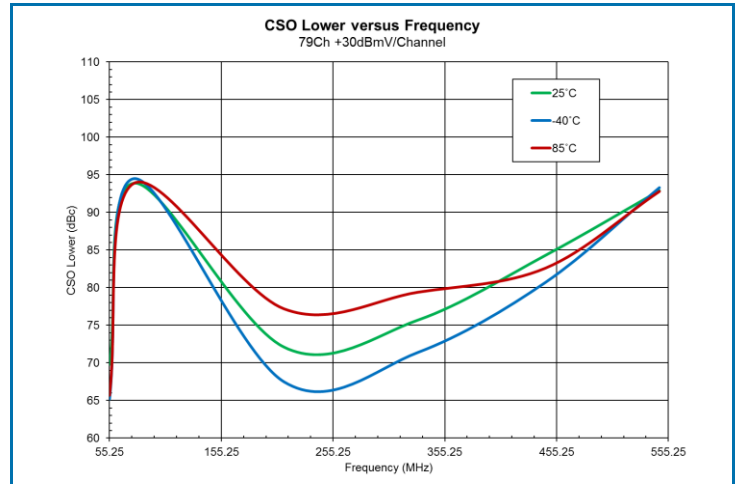
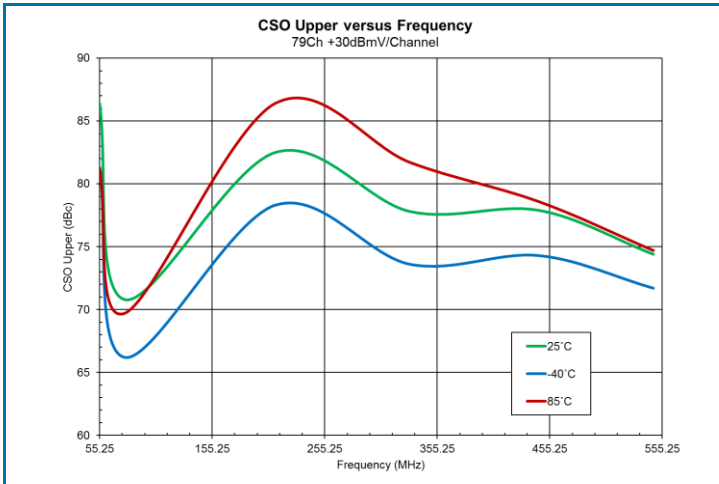

Evaluation Board Schematic 50MHz to 1200MHz Application Circuit

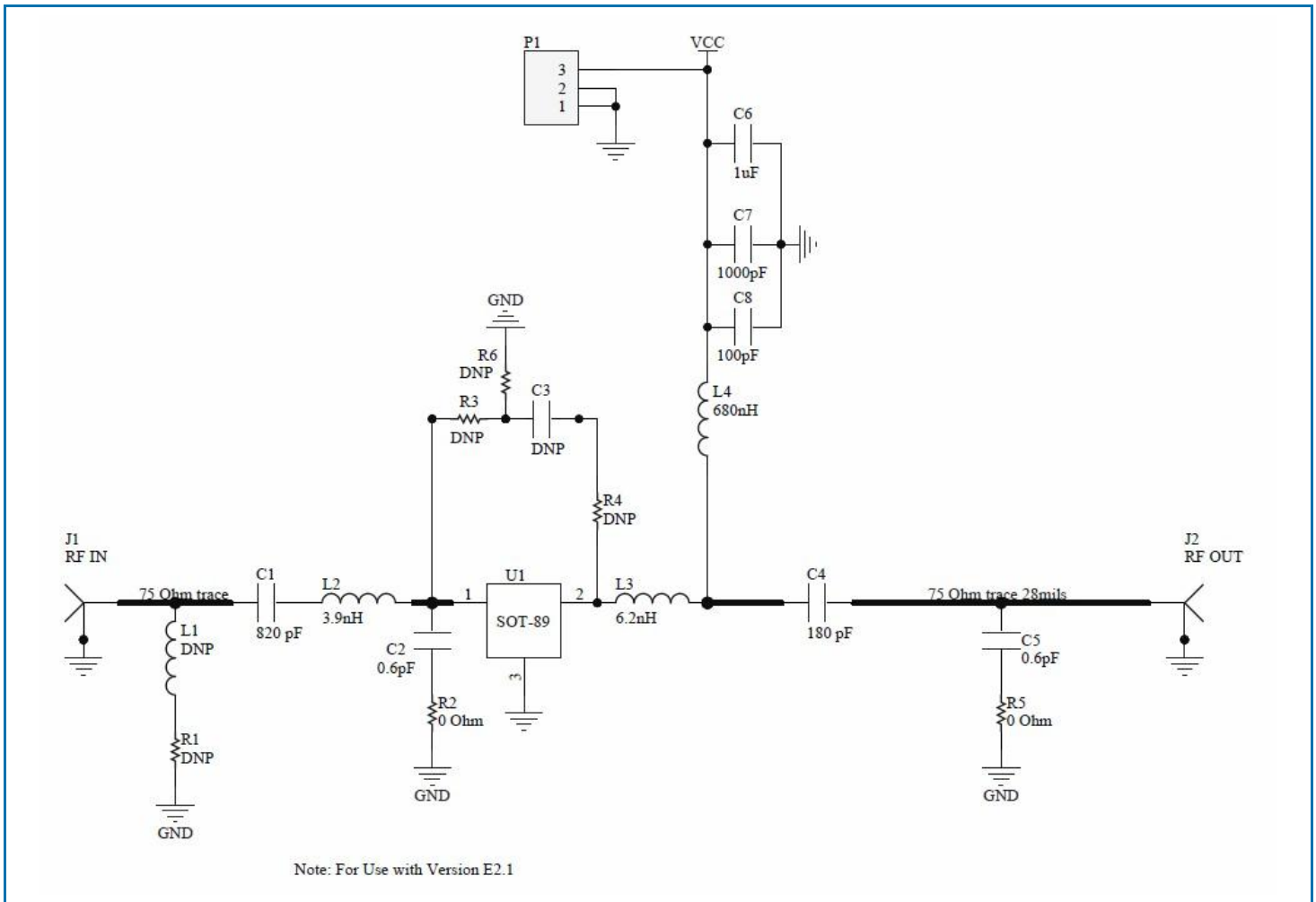

Evaluation Board Bill of Materials (BOM) 50MHz to 1200MHz Application Circuit

Description	Reference Designator	Manufacturer	Manufacturer's P/N
RFCA3828 Evaluation Board		Dynamic Details (DDI) Toronto	RFCA3828-410(A)
pHEMT CATV Amplifier	U1	RFMD	RFCA3828
CAP, 820pF, 5%, 50V, C0G, 0402	C1	Murata Electronics	GRM1555C1H821JA01
CAP, 0.6pF, +/-0.1pF, 50V, HI-Q, 0402	C2, C5	Murata Electronics	GRM1555C1HR60BB01D
CAP, 180pF, 5%, 50V C0G, 0402	C4	Murata Electronics	GRM1555C1H181JA01D
CAP, 1.0µF, 10%, 16V, X7R, 0603	C6	Murata Electronics	GRM188R61A105KA61D
CAP, 1000pF, 5%, 50V, C0G, 0603	C7	Murata Electronics	GRM1885CH1H102JA01
CAP, 100pF, 5%, 50V, C0G, 0603	C8	Murata Electronics	GRM1885C1H101JA01D
RES, 0Ω, 0402 KAMAYA	R2, R5	Kamaya, Inc.	RMC1/16SJPTH
IND, 3.9nH, +/-0.1nH, T/F, 0402	L2	Coilcraft, Inc.	LQP15MN3N9B02D
IND, 6.2nH, +/-0.1nH, T/F, 0402	L3	Coilcraft, Inc.	LQG15MN6N2B02D
IND, 680nH, 5%, W/W, 0805	L4	Coilcraft, Inc.	0805LS-861XJLC
CONN, HDR, ST, PLRZD, 3-PIN, 0.100"	P1	Samtec Inc.	TSW-102-07-G-S
CONN, F FEM EDGE MOUNT, 75Ω, 0.068"	J1-J2	Millimeter Wave, LLC	MW-846-C-DD-75
HEATSINK BLOCK		Robert S. Wells	Heat Sink
SCREW, 2-56 x 3/16", SOCKET HEAD	S1-S5	McMaster-Carr Supply Co.	92196A076
DNP	C3, R1, R3-R4, R6, L1		

Evaluation Board Assembly Drawing 50MHz to 1200MHz Application Circuit

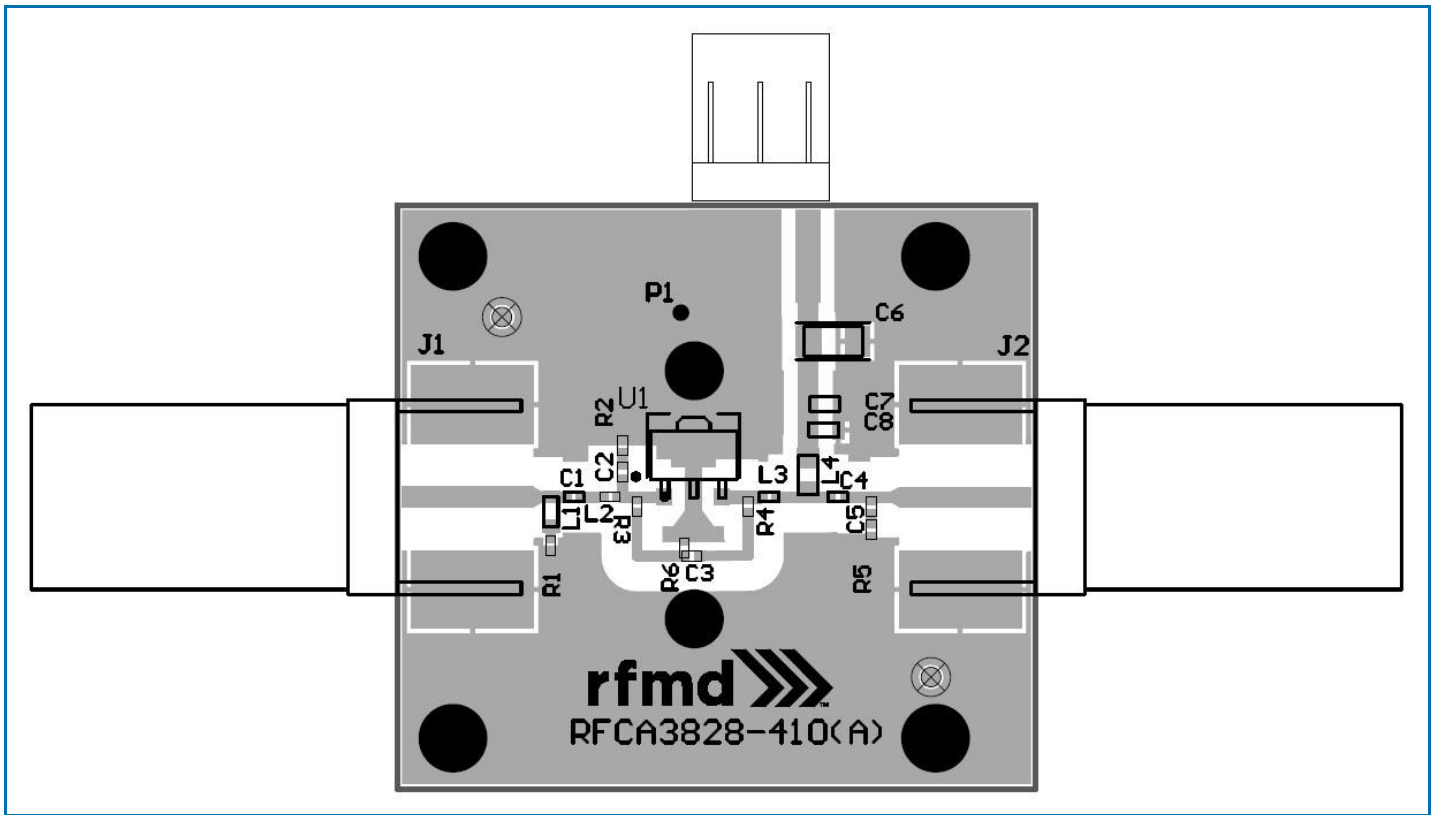

Pin Names and Descriptions

Pin	Name	Description
1	RFIN	RF Input; External DC blocking capacitor is required
2	GND	Connection to ground; Use via holes for best performance to reduce lead inductance as close to ground leads as possible
3	RFOUT/VDD	RF Output; Device Drain. DC voltage is present on this pin, therefore a DC blocking capacitor is necessary for proper operation.

Package Outline (Dimensions in millimeters)

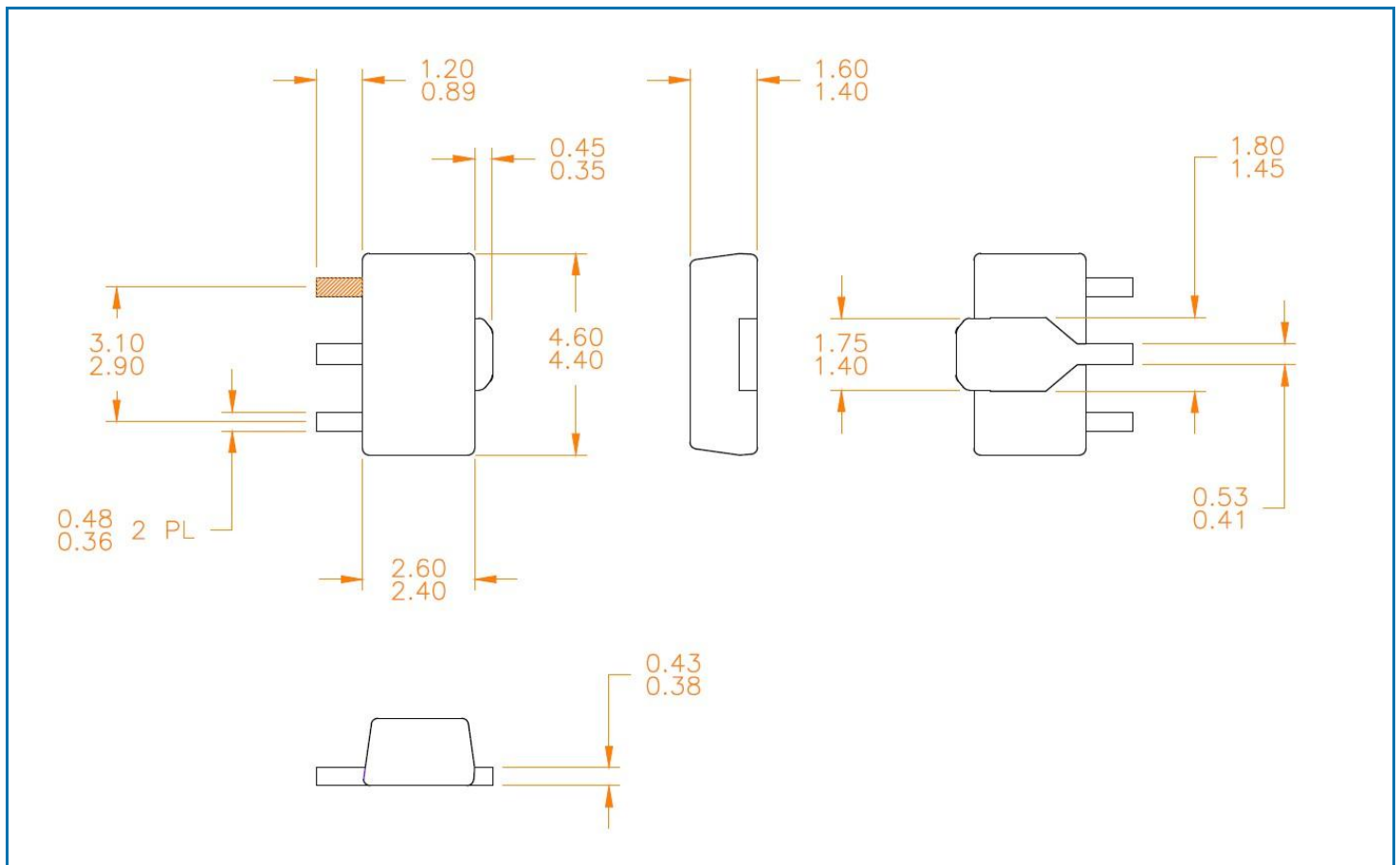

Branding Diagram

