



3mm Lamp Type 940nm Infrared Emitter

Features

- High radiant intensity
- Viewing Angle = $\pm 25^\circ$
- High reliability
- Good spectral matching to Si photo detector
- RoHS compliance

Applications

- Infrared sensor
- Remote control

Description

The IR300N-F0 is a GaAlAs infrared LED diode. The device has a peak wavelength of 940nm LED spectrally matched with phototransistor or photodiode.

Package Outline

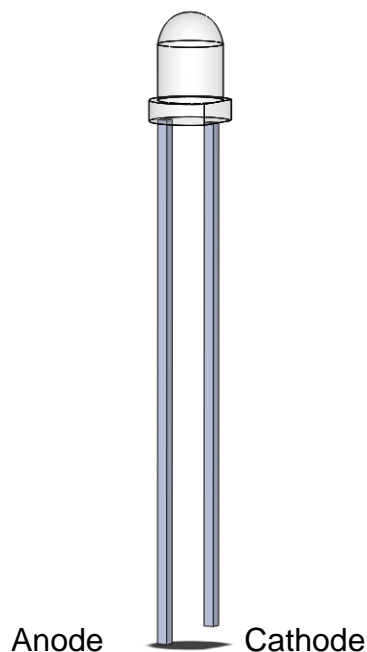

Schematic

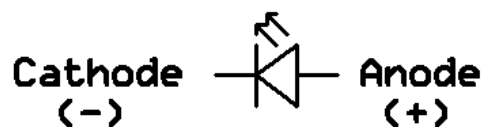

**Absolute Maximum Rating at 25°C**

Symbol	Parameters	Ratings	Units	Notes
I _F	Continuous Forward Current	100	mA	
I _{FP}	Peak Forward Current	1.0	A	1
V _R	Reverse Voltage	5	V	
T _{opr}	Operating Temperature	-40 ~ +85	°C	
T _{stg}	Storage Temperature	-40 ~ +100	°C	
T _{sol}	Soldering Temperature	260	°C	2
P _D	Power Dissipation at(or below) 25°C Free Air Temperature	180	mW	

Electro-Optical Characteristics *TA = 25°C (unless otherwise specified)***Optical Characteristics**

Symbol	Parameters	Test Conditions	Min	Typ	Max	Units	Notes
I _e	Radiant Intensity	I _F =20mA	4.0	7.0	20	mW/sr	3
		I _F =100mA, T _p =20ms	-	32	-		
λ _p	Peak Wavelength	I _F =20mA	-	940	-	nm	
Δλ	Spectral Bandwidth	I _F =20mA	-	50	-	nm	
θ _{1/2}	Angle of Half Intensity	I _F =20mA	-	±25	-	deg	

Electrical Characteristics

Symbol	Parameters	Test Conditions	Min	Typ	Max	Units	Notes
V _F	Forward Voltage	I _F =20mA	1.1	1.2	1.5	V	
		I _F =100mA, T _p =20ms	1.2	1.39	1.8		
I _R	Reverse Current	V _R =5V	-	-	10	μA	

Notes:

- 1 : I_{FP} Conditions--Pulse Width ≤ 100μs and Duty ≤ 1%.
- 2 : Soldering time ≤ 5 seconds.
- 3.: I_e Bin Rank :

Bin Code	G	H	I
Min	4.0	6.5	10
Max	8.0	13	20



Typical Characteristic Curves

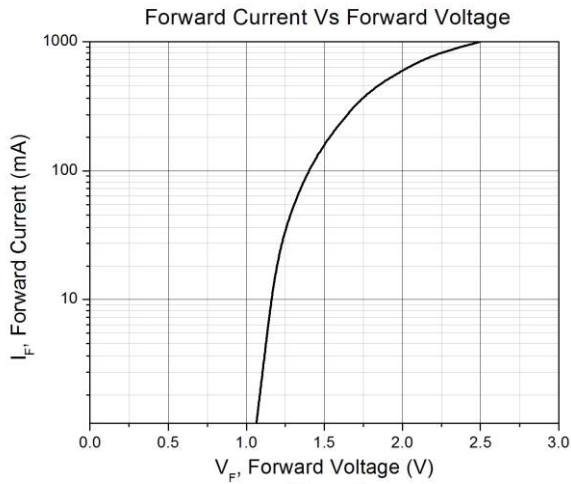

Figure 1

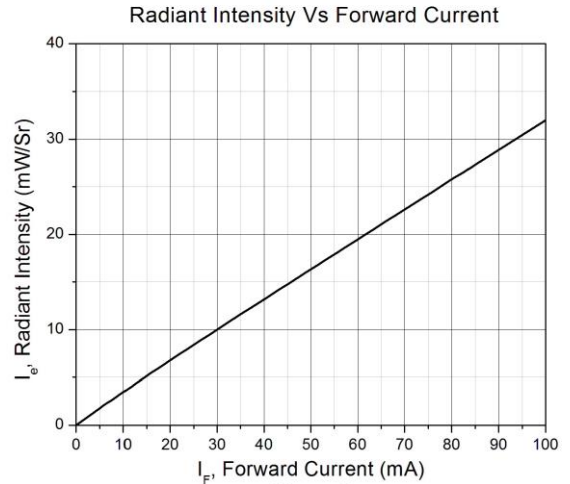

Figure 2

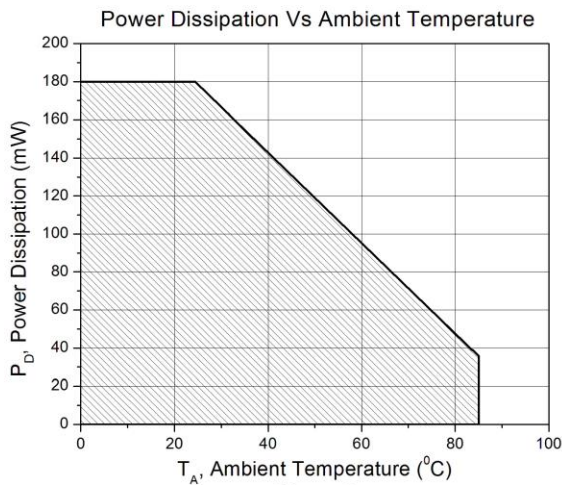

Figure 3

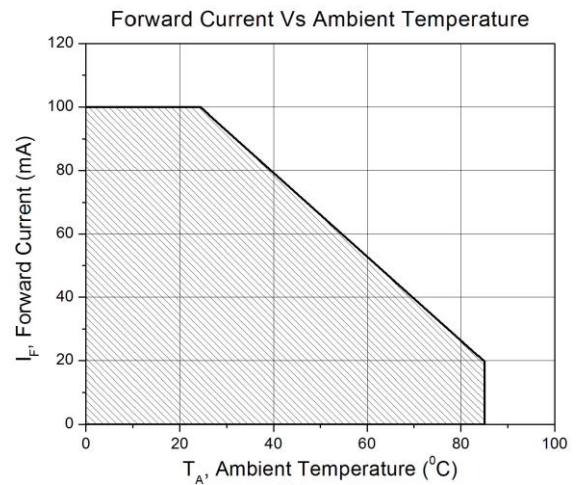

Figure 4

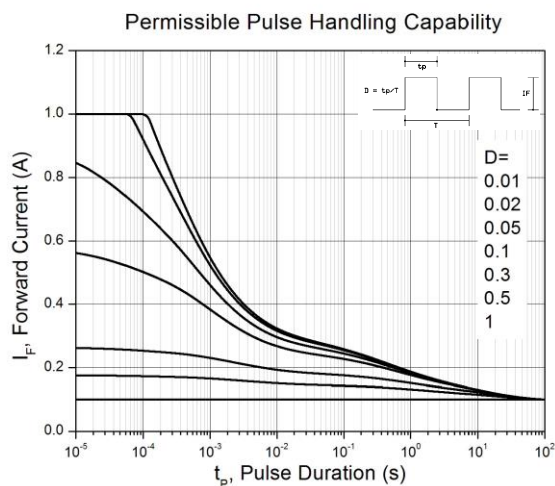

Figure 5

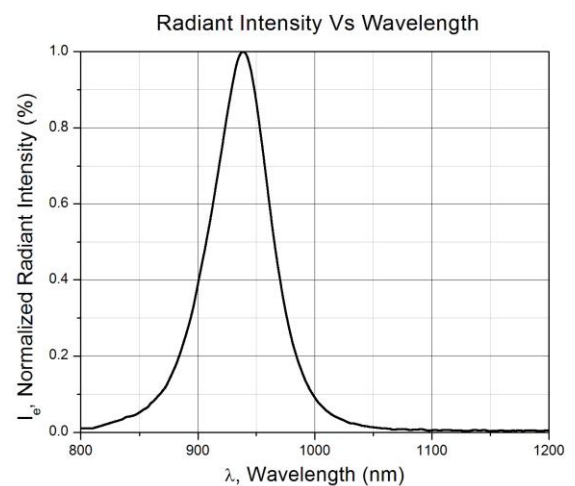
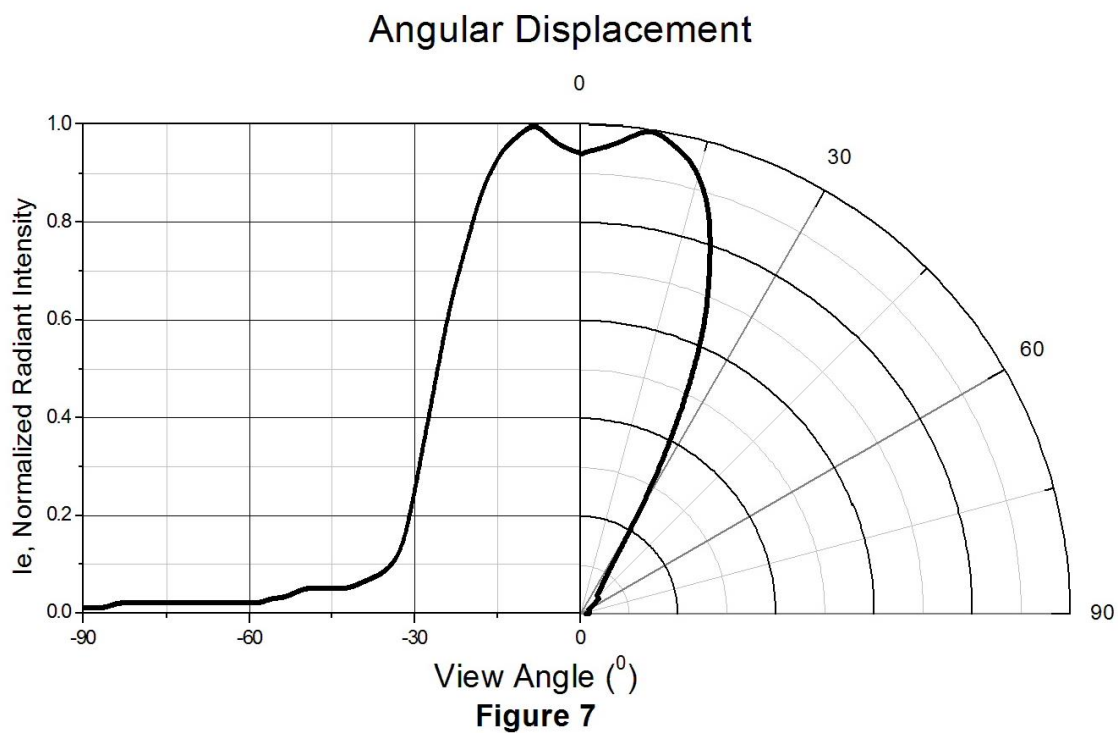

Figure 6



Typical Characteristic Curves





3mm Lamp Type 940nm Infrared Emitter

Package Dimension *All dimensions are in mm, unless otherwise stated.*

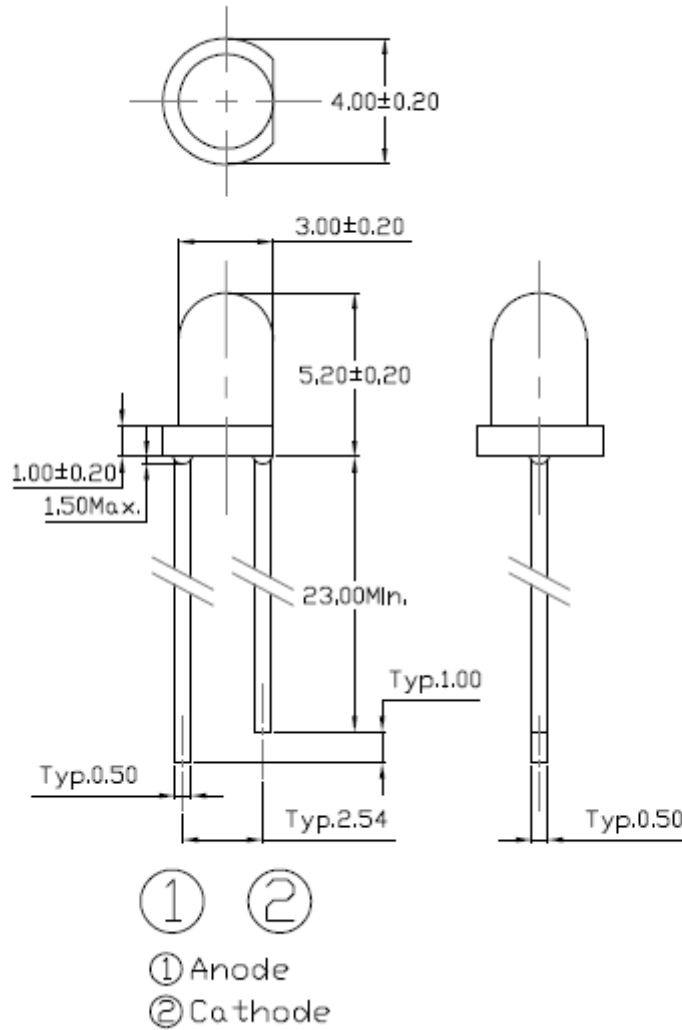



IR300N-F0

3mm Lamp Type 940nm Infrared Emitter

Ordering Information

IR300N-F0/(XX)(YYY)

XX = TR – Tape & Reel / TB – Tape & Box

YYY = H; H- Refer to Tape dimension drawing (255 = 25.5mm)

Part Number	Description	Quantity
IR300N-F0	1 Bag	500 pcs
	1 Box	10 bag
	1 Carton	8 box
IR300N-F0/TR(H) Tape & Reel	1 Reel	1000 pcs
	1 Carton	8 box
IR300N-F0/TB(H) Tape & Box	1 Box	2000pcs
	1 Carton	8 box



3mm Lamp Type 940nm Infrared Emitter

Tape Dimension *All dimensions are in mm, unless otherwise stated.*

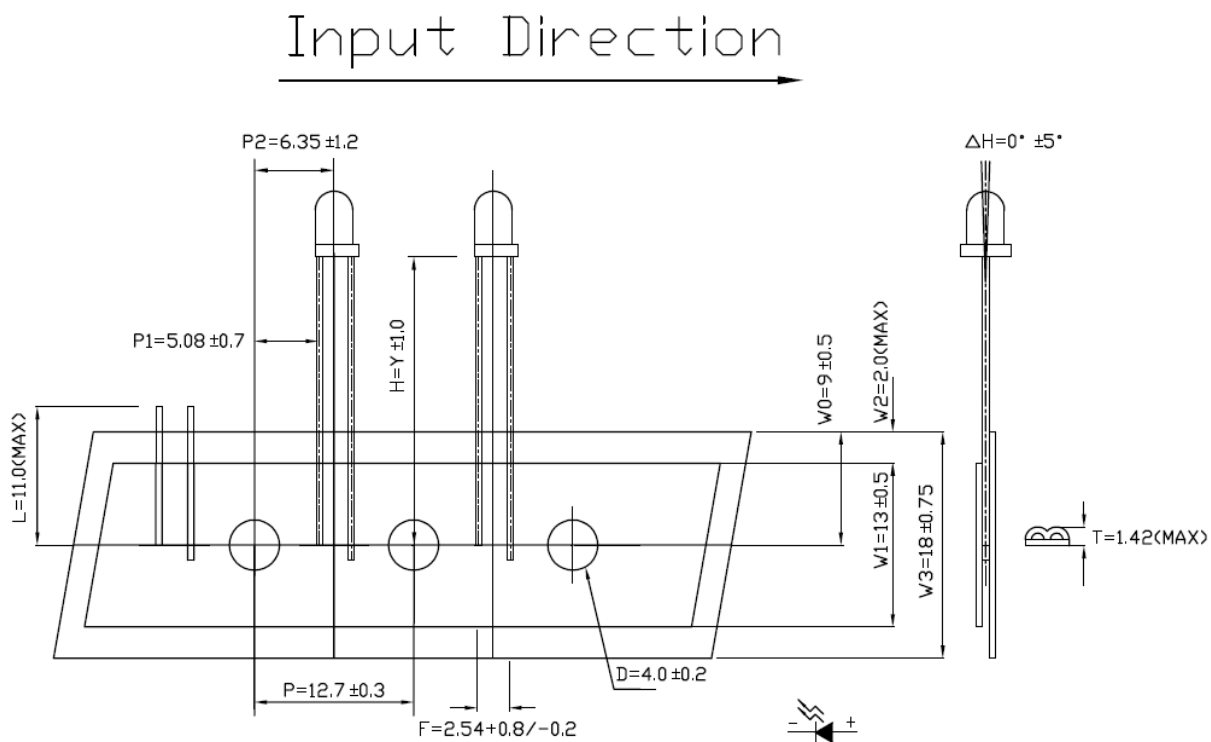



DISCLAIMER

CT MICRO RESERVES THE RIGHT TO MAKE CHANGES WITHOUT FURTHER NOTICE TO ANY PRODUCTS HEREIN TO IMPROVE RELIABILITY, FUNCTION OR DESIGN. CT MICRO DOES NOT ASSUME ANY LIABILITY ARISING OUT OF THE APPLICATION OR USE OF ANY PRODUCT OR CIRCUIT DESCRIBED HEREIN; NEITHER DOES IT CONVEY ANY LICENSE UNDER ITS PATENT RIGHTS, NOR THE RIGHTS OF OTHERS.

CT MICRO ARE NOT AUTHORIZED FOR USE AS CRITICAL COMPONENTS IN LIFE SUPPORT DEVICES OR SYSTEMS WITHOUT EXPRESS WRITTEN APPROVAL OF CT MICRO INTERNATIONAL CORPORATION.

- 1. Life support devices or systems are devices or systems which, (a) are intended for surgical implant into the body, or (b) support or sustain life, or (c) whose failure to perform when properly used in accordance with instruction for use provided in the labelling, can be reasonably expected to result in significant injury to the user.*
- 2. A critical component is any component of a life support device or system whose failure to perform can be reasonably expected to cause the failure of the life support device or system, or to affect its safety or effectiveness.*