

THIS DRAWING IS UNPUBLISHED. RELEASED FOR PUBLICATION DEC. 2004.  
 © COPYRIGHT 2004 BY TYCO ELECTRONICS CORPORATION. ALL RIGHTS RESERVED.

LOC	DIST	REVISIONS 変更			
P	LTR	DESCRIPTION	DATE	DWN	APVD
	A	REVISED	23JUN2010	Y.W	S.K
	B	ECR-13-012512	09AUG2013	IT	WKH

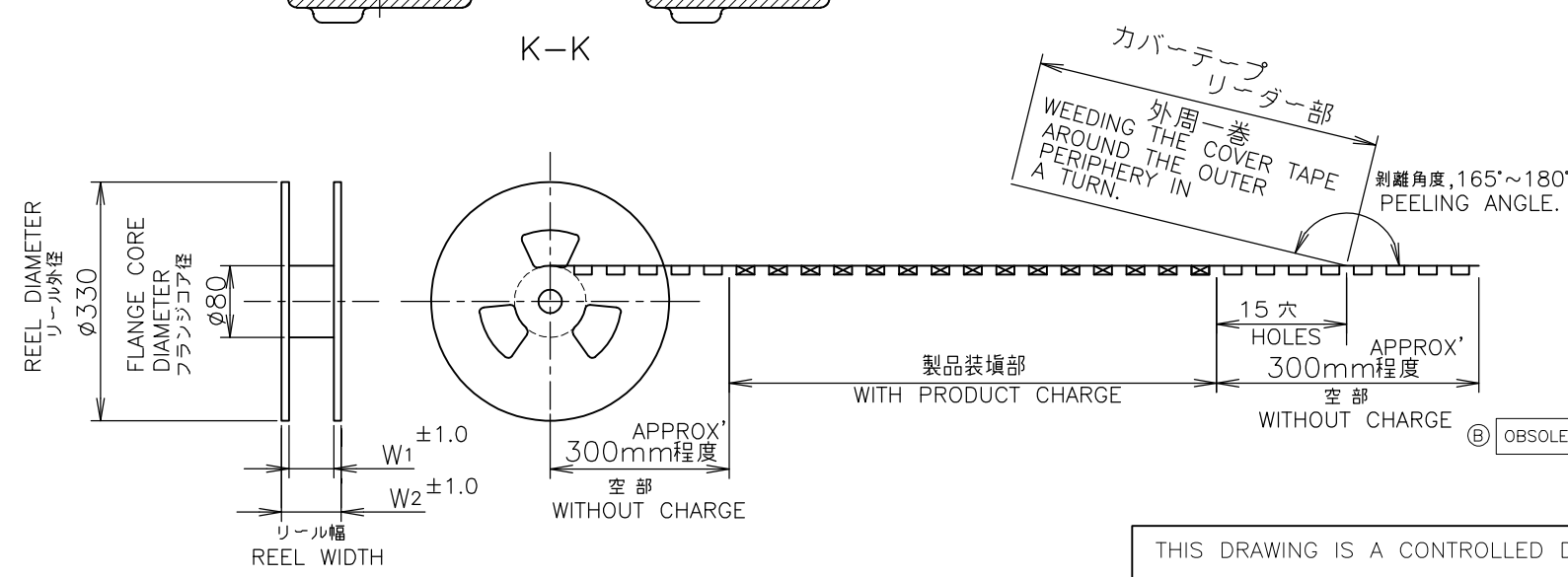
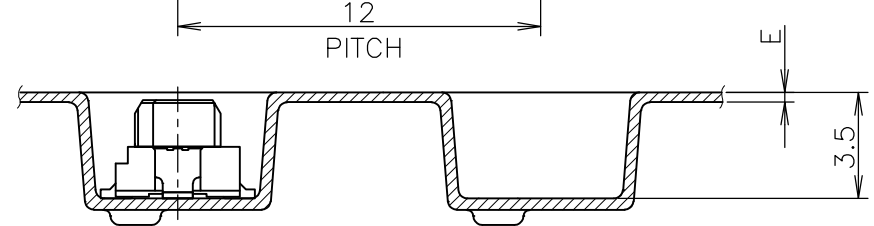
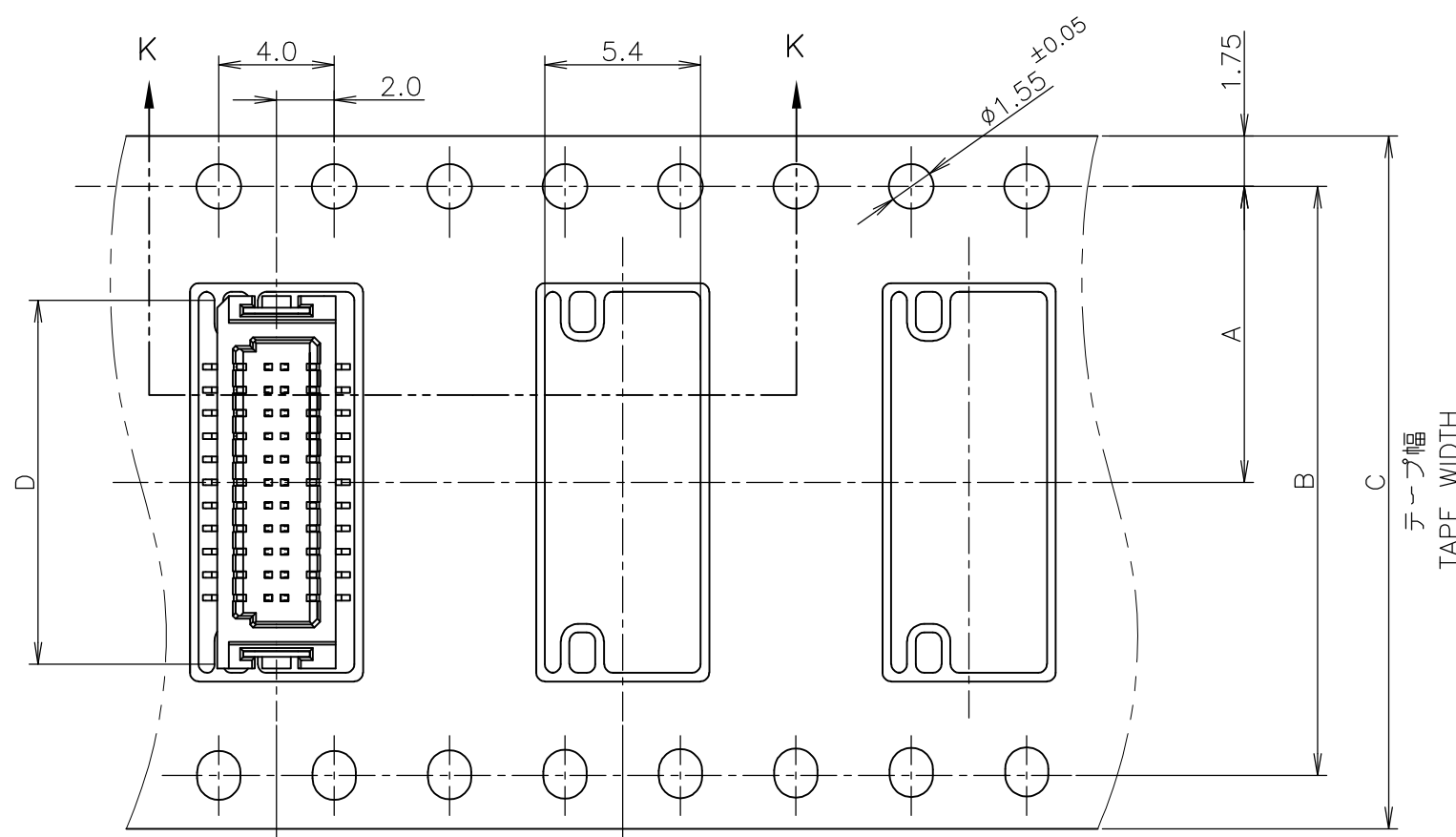

カバーテープ  
リーダー部  
外周一巻  
WEEDING AROUND THE COVER TAPE PERIPHERY IN A TURN.  
剥離角度, 165°~180°  
PEELING ANGLE.

COLOR	W2	W1	E	D	C	B	A	数量 (ヶ) QTY/REEL	極数 POS	リール巻 コネクタ型番 TAPING P/N
NATURAL	48.7	45.5	0.4	28.4	44	40.4	20.2	1000	60	6-5917408-0
NATURAL	29.5	25.5	0.38	13.2	24	11.5	11.5	1000	22	2-5917408-2
BLACK	22	18	0.5	8.4	16	7.5	7.5	1000	10	1-5917408-0

THIS DRAWING IS A CONTROLLED DOCUMENT.

DWN: M.IWASAKI 27DEC04  
 CHK: Y.NAKAZAWA 27DEC04  
 APVD: T.KUSUHARA 27DEC04

**Tyco Electronics** Tyco Electronics AMP K.K. Kawasaki, Japan

ON TAPING EMBOSS  
 0.8mm PITCH B-TO-B CONN  
 RECEPTACLE ASSEMBLY WITH KEY & BOSS

SIZE: A3 CAGE CODE: 00779 DRAWING NO: G-5917408 RESTRICTED TO: -

SCALE: 4:1 SHEET: 1 OF 2 REV: B

GENERAL TOLERANCE  
一般公差

10 ≥ : ±0.2  
 30 ≥ > 10: ±0.25  
 100 ≥ > 30: ±0.3  
 ANGLES: ±3°

DIMENSIONS: 単位: 純 mm	TOLERANCES UNLESS OTHERWISE SPECIFIED: 一般公差
	0 PLC ±
	1 PLC ±
	2 PLC ±
	3 PLC ±
	4 PLC ±
	ANGLES ±
MATERIAL 材料	FINISH 仕上

THIS DRAWING IS UNPUBLISHED. RELEASED FOR PUBLICATION DEC. 2004.  
 © COPYRIGHT 2004 BY TYCO ELECTRONICS CORPORATION. ALL RIGHTS RESERVED.

LOC	DIST	REVISIONS		
J		変更	DATE	DWN
P	LTR	DESCRIPTION		APVD
		SEE SHEET 1	-	-

本図：コネクタ図  
 AS SHOWN: CONNECTOR DWG

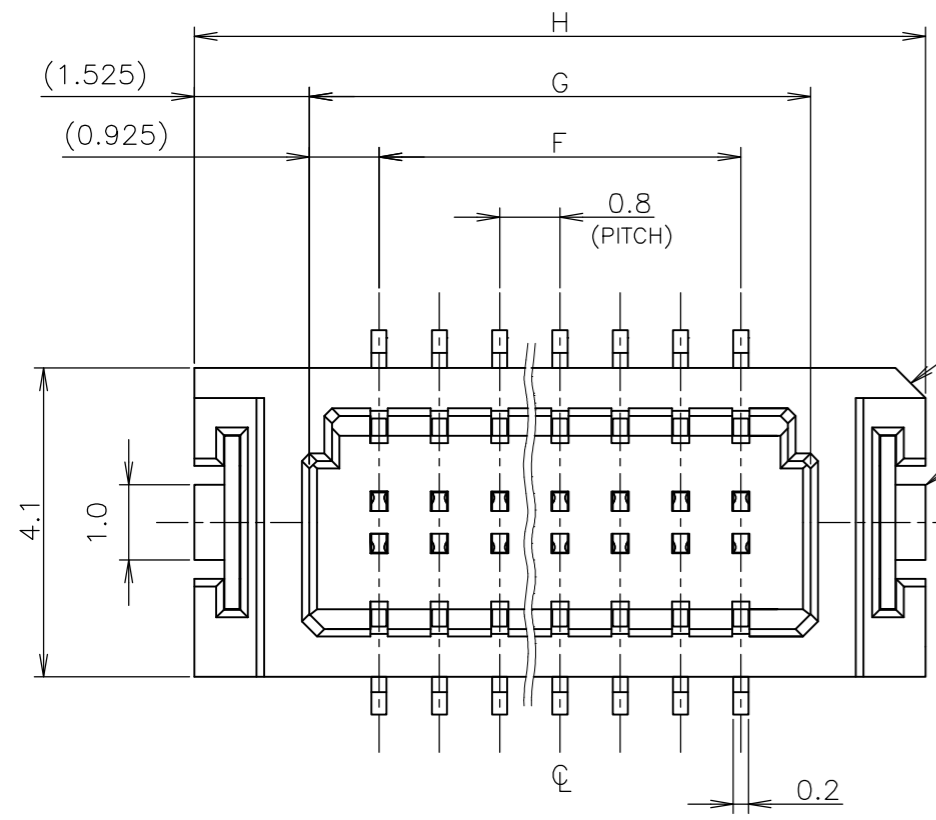

リセプタクルハウジング  
 RECEPTACLE HOUSING

回路番号1側  
 CIRCUIT NO.1 SIDE

テールプレート  
 TAIL PLATE

リセプタクルコンタクト  
 RECEPTACLE CONTACT

2.1

L-L

コネクタ位置  
 CONN. POSITION

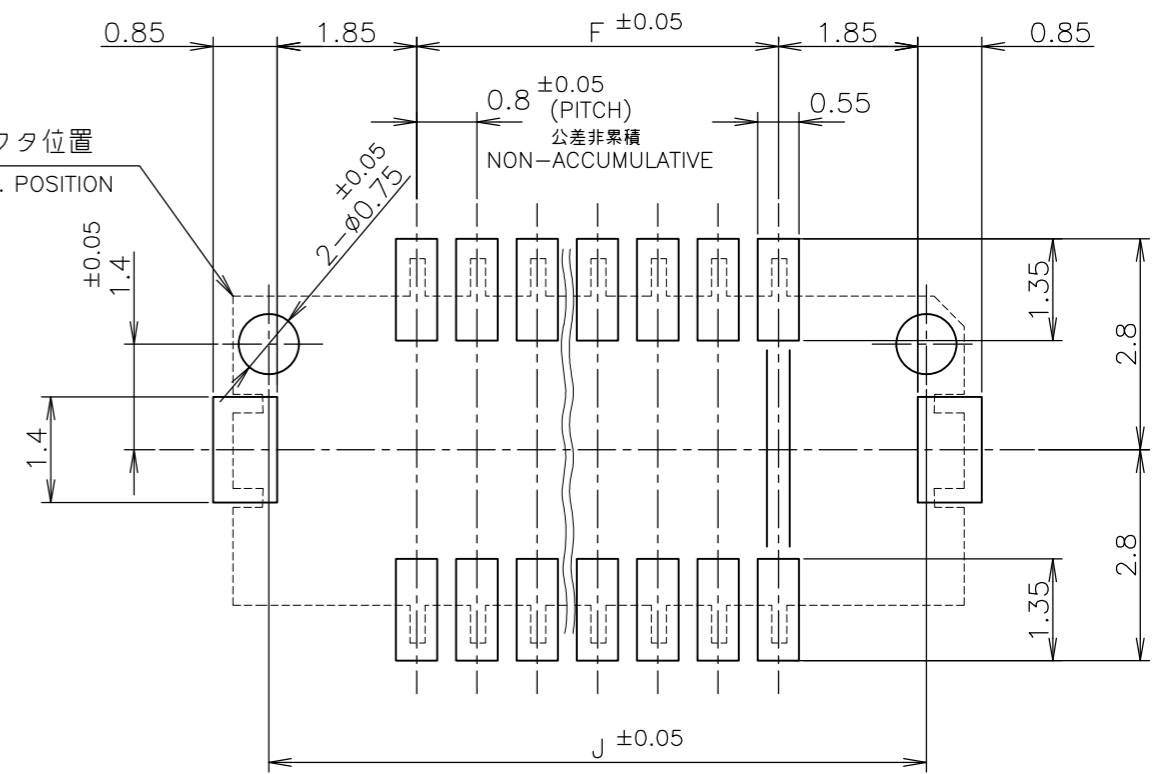

参考基板加工寸法  
 REFERENCE P.C. BOARD LAYOUT

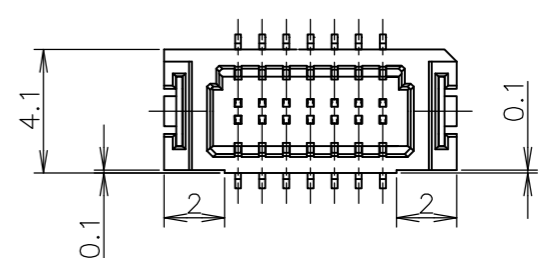

SCALE 4:1  
 AS SHOWN: 1-5917408-0 ONLY

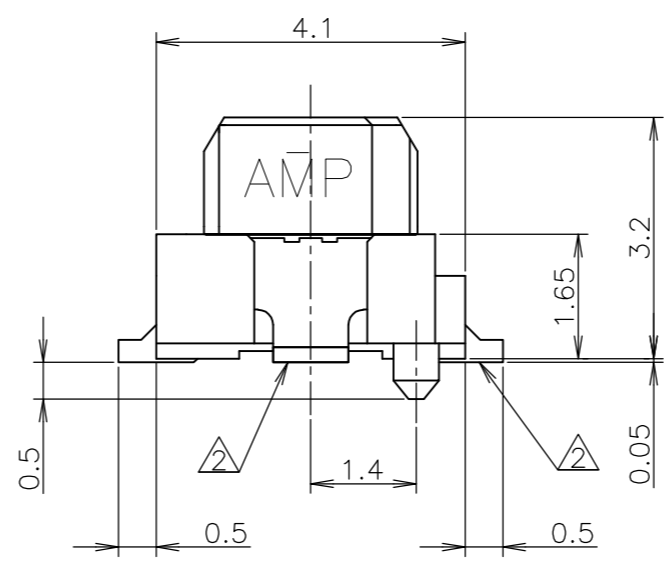
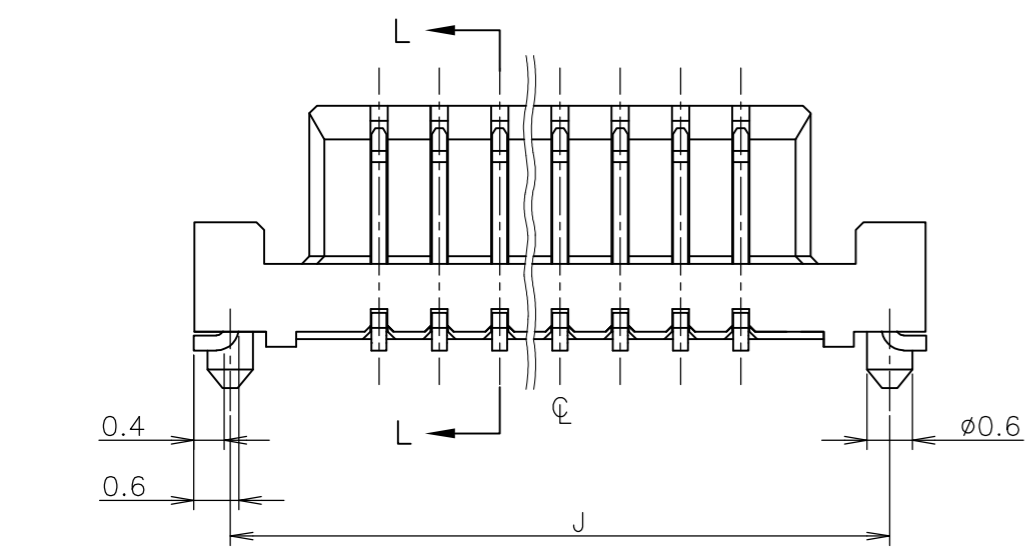

- 1 材料：リセプタクルハウジング：46ナイロン (耐熱性樹脂)
- リセプタクルコンタクト：銅合金 (t=0.2mm) 金めっき
- テールプレート：銅合金 (t=0.2mm) 錫めっき

△ 全てのタイン部及びテールプレートのバラツキは 0.1mm MAX.

- 1 MATERIAL
- REC HOUSING: 46 NYLON (HIGH HEAT-RESISTED RESIN)
- REC CONTACT: COPPER-ALLOY (t=0.2mm) Au PLATING
- TAIL PLATE: COPPER-ALLOY (t=0.2mm) TIN PLATING

△ MISALIGNMENT BETWEEN TAINS AND TAIL PLATE: 0.1mm MAX.

GENERAL TOLERANCE 一般公差

10 ≥	±0.2
30 ≥ > 10	±0.25
100 ≥ > 30	±0.3
ANGLES	±3°

THIS DRAWING IS A CONTROLLED DOCUMENT.

DIMENSIONS: 単位： 耗 mm	TOLERANCES UNLESS OTHERWISE SPECIFIED: 一般公差
	0 PLC ±
	1 PLC ±
	2 PLC ±
	3 PLC ±
MATERIAL 材料	4 PLC ±
	ANGLES ±
	FINISH 仕上

INSTRUCTION SHEET 取扱説明書	411-5808
DWN	
CHK	
APVD	
PRODUCT SPEC 製品規格	108-5512
APPLICATION SPEC 取付適用規格	
WEIGHT	
CUSTOMER DRAWING	

27.15	28.1	25.05	23.2	60	6-5917408-0
11.95	12.9	9.85	8.0	22	2-5917408-2
7.15	8.1	5.05	3.2	10	1-5917408-0
J	H	G	F	極数 POS	型番 PART NO

**Tyco Electronics** Tyco Electronics AMP K.K. Kawasaki, Japan

ON TAPING EMBOSS  
 0.8mm PITCH B-TO-B CONN  
 RECEPTACLE ASSEMBLY WITH KEY & BOSS

SIZE	CAGE CODE	DRAWING NO 番号	RESTRICTED TO
A3	00779	5917408	-

SCALE 尺度 10:1 SHEET 2 OF 2 REV B