

Pb Free Plating Product

L4204S



20 Ampere, 400 Volt Common Cathode Fast Recovery Epitaxial Diode

APPLICATION

- Freewheeling, Snubber, Clamp
- Inversion Welder
- PFC
- Plating Power Supply
- Ultrasonic Cleaner and Welder
- Converter & Chopper
- UPS

PRODUCT FEATURE

- Ultrafast Recovery Time
- Soft Recovery Characteristics
- Low Recovery Loss
- Low Forward Voltage
- High Surge Current Capability
- Low Leakage Current

TO-247AD/TO-3P

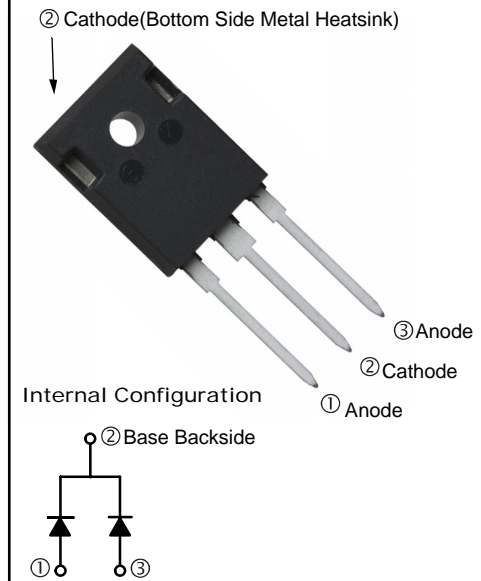

GENERAL DESCRIPTION

L4204S using the latest FRED FAB process(planar passivation chip) with ultrafast and soft recovery characteristic.

ABSOLUTE MAXIMUM RATINGS

 $T_C=25^{\circ}\text{C}$ unless otherwise specified

Symbol	Parameter	Test Conditions	Values	Unit
V_R	Maximum D.C. Reverse Voltage		400	V
V_{RRM}	Maximum Repetitive Reverse Voltage		400	V
$I_{F(AV)}$	Average Forward Current	$T_C=110^{\circ}\text{C}$, Per Diode	10	A
		$T_C=110^{\circ}\text{C}$, Per Package	20	A
$I_{F(RMS)}$	RMS Forward Current	$T_C=110^{\circ}\text{C}$, Per Diode	14	A
I_{FSM}	Non-Repetitive Surge Forward Current	$T_J=45^{\circ}\text{C}$, $t=10\text{ms}$, 50Hz, Sine	100	A
P_D	Power Dissipation		83	W
T_J	Junction Temperature		-40 to +150	$^{\circ}\text{C}$
T_{STG}	Storage Temperature Range		-40 to +150	$^{\circ}\text{C}$
Torque	Module-to-Sink	Recommended (M3)	1.1	N·m
$R_{\theta JC}$	Thermal Resistance	Junction-to-Case	1.5	$^{\circ}\text{C}/\text{W}$
Weight			6	g

ELECTRICAL CHARACTERISTICS

 $T_C=25^{\circ}\text{C}$ unless otherwise specified

Symbol	Parameter	Test Conditions	Min.	Typ.	Max.	Unit
I_{RM}	Reverse Leakage Current	$V_R=400\text{V}$	--	--	15	μA
		$V_R=400\text{V}$, $T_J=125^{\circ}\text{C}$	--	--	250	μA
V_F	Forward Voltage	$I_F=10\text{A}$	--	1.00	--	V
		$I_F=10\text{A}$, $T_J=125^{\circ}\text{C}$	--	0.87	--	V
t_{rr}	Reverse Recovery Time	$I_F=1\text{A}$, $V_R=30\text{V}$, $di_F/dt=-200\text{A}/\mu\text{s}$	--	20	--	ns
t_{rr}	Reverse Recovery Time	$V_R=200\text{V}$, $I_F=10\text{A}$	--	25	--	ns
I_{RRM}	Max. Reverse Recovery Current	$di_F/dt=-200\text{A}/\mu\text{s}$, $T_J=25^{\circ}\text{C}$	--	2.2	--	A
t_{rr}	Reverse Recovery Time	$V_R=200\text{V}$, $I_F=10\text{A}$	--	46	--	ns
I_{RRM}	Max. Reverse Recovery Current	$di_F/dt=-200\text{A}/\mu\text{s}$, $T_J=125^{\circ}\text{C}$	--	5.5	--	A

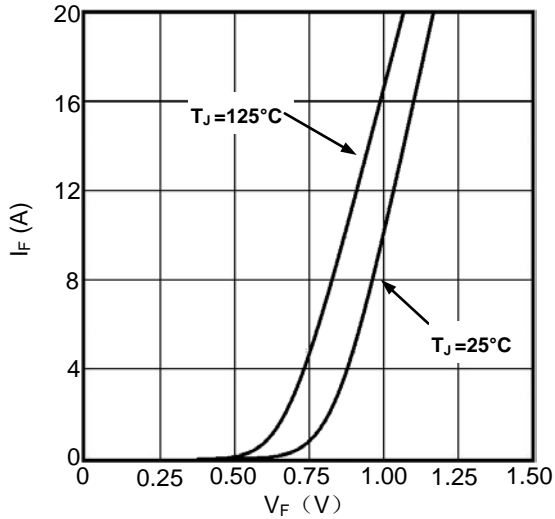

Fig1. Forward Voltage Drop vs Forward Current

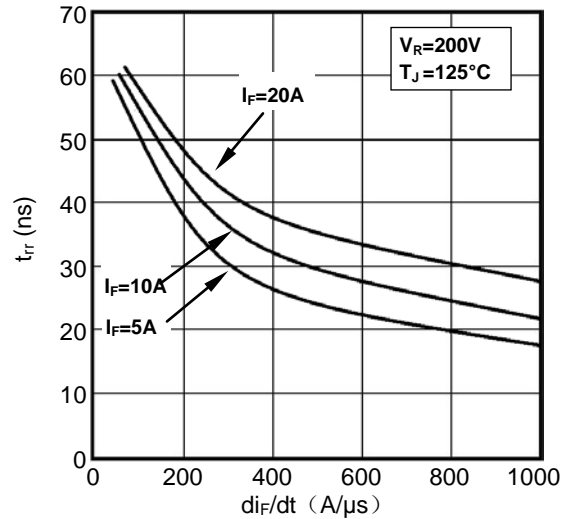

Fig2. Reverse Recovery Time vs di_F/dt

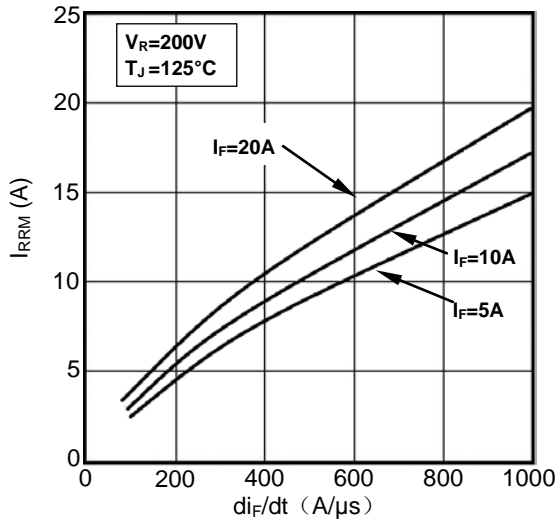

Fig3. Reverse Recovery Current vs di_F/dt

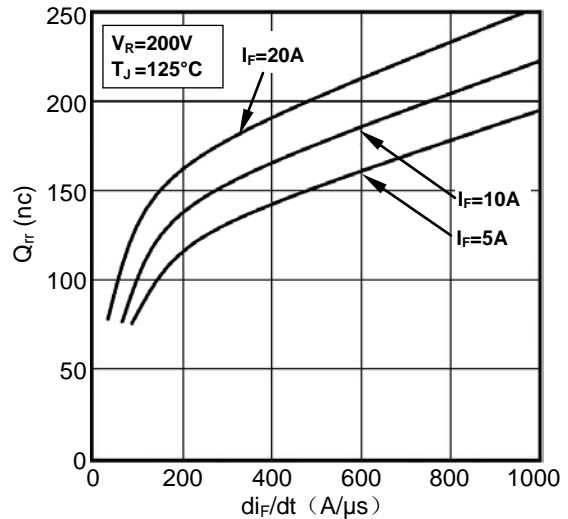

Fig4. Reverse Recovery Charge vs di_F/dt

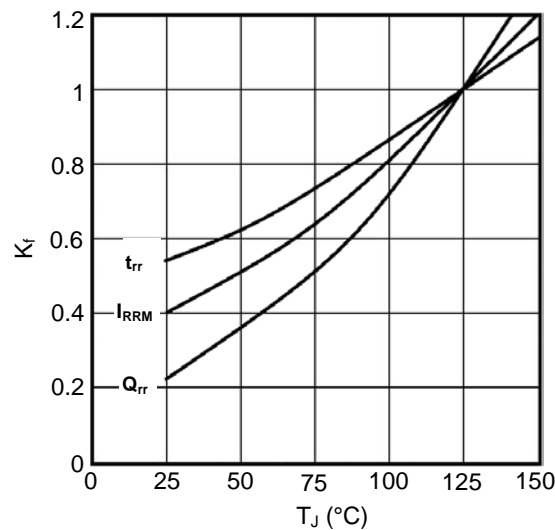

Fig5. Dynamic Parameters vs Junction Temperature

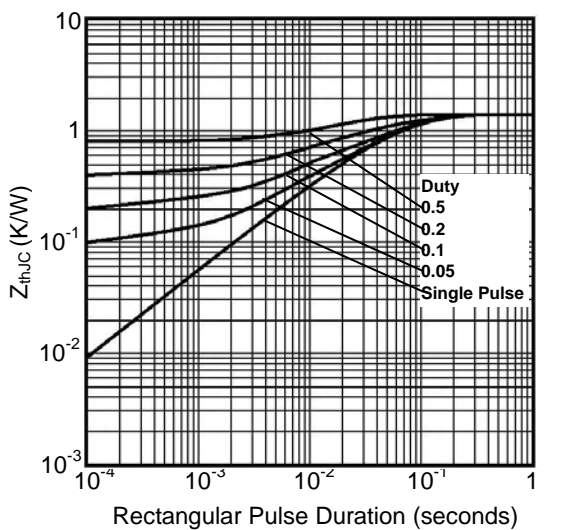

Fig6. Transient Thermal Impedance

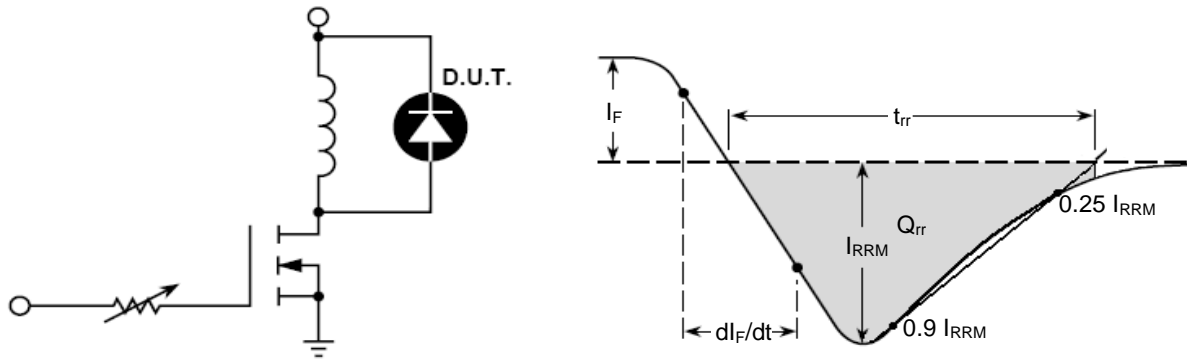
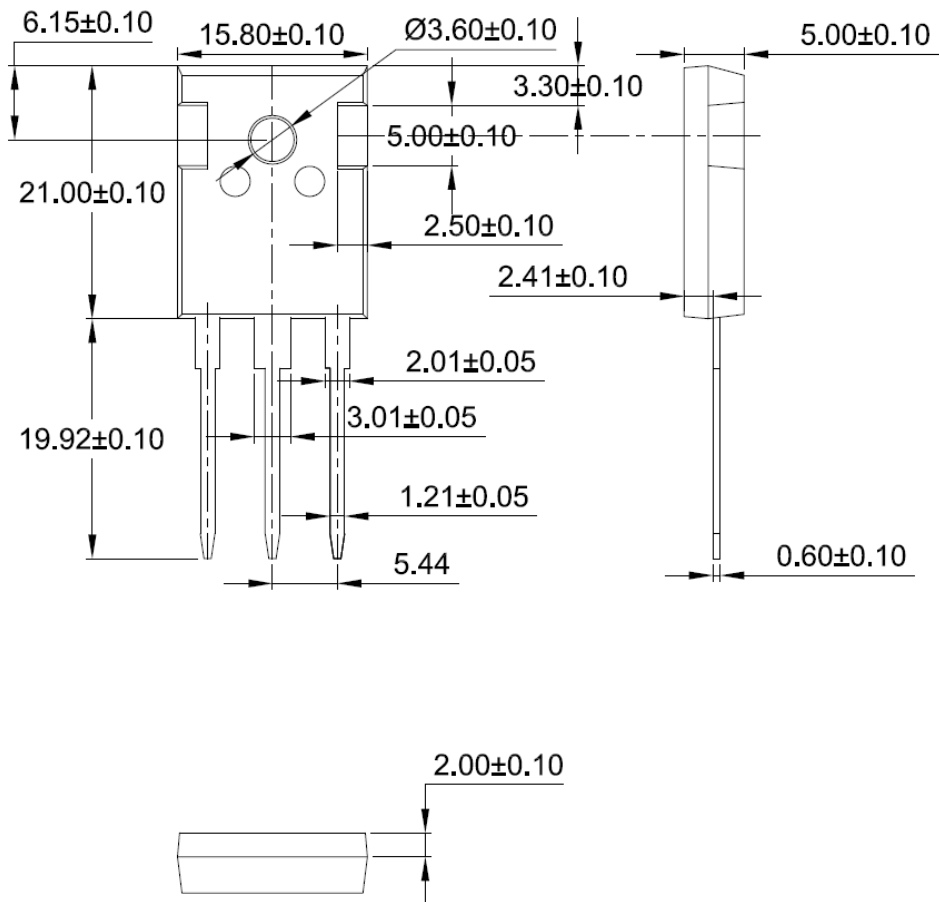

Fig7. Diode Reverse Recovery Test Circuit and Waveform



Dimensions in Millimeters
Fig8. Package Outline