

$V_Z(\text{max.}) = 30 \text{ V} / 44 \text{ V}$
Transient Voltage Suppressor
SZ-10 Series

Description

SanKen SZ-10 series devices are power zener diodes designed for the protection of automotive electronic units from especially the surge generated during load dump conditions, voltage transients induced by inductive loads. The package of the IC has high dissipation and high surge capability.

Features

- AEC-Q101 Qualified
- Meets ISO7637-2 Surge Protection Specification (Pulse 5a)
- $T_J = 175 \text{ }^\circ\text{C}$ Capability Suitable for High Reliability and Automotive Requirement
- High Surge Capability
- Flammability UL94V-0 (Equivalent)
- Compliant with RoHS Directive

Typical Application

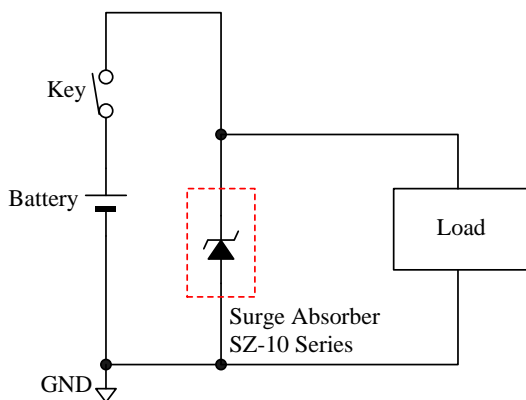

Package

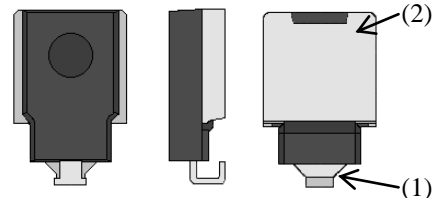

(1) Cathode
 (2) Anode

Not to Scale

SZ-10 Series

Products	V_Z		I_{RSM}	P_D
	Min.	Max.		
SZ-10N27	24 V	30 V	70 A	5 W
SZ-10NN27			90 A	6 W
SZ-10N40	36 V	44 V	45 A	5 W
SZ-10NN40			70 A	6 W

Application

Protection of sensitive electronic equipment in passenger cars, trucks, vans and buses:

- Engine Control Units
- Electric Control Units
- Braking System
- Power Steering System
- Airbags
- Audio & Infotainment Equipment

CONTENTS

Description ----- 1
CONTENTS ----- 2
1. Absolute Maximum Ratings ----- 3
2. Electrical Characteristics ----- 4
3. Performance Curves ----- 4
 3.1 Power Dissipation ----- 4
 3.2 Peak Surge Reverse Power Capability ----- 5
 3.3 SZ-10N27 Typical Characteristics ----- 6
 3.4 SZ-10NN27 Typical Characteristics ----- 7
 3.5 SZ-10N40 Typical Characteristics ----- 8
 3.6 SZ-10NN40 Typical Characteristics ----- 9
4. External Dimensions ----- 10
5. Marking Diagram ----- 10
IMPORTANT NOTES ----- 11

SZ-10 Series

1. Absolute Maximum Ratings

Unless specifically noted $T_A = 25\text{ }^\circ\text{C}$.

Parameter	Symbol	Conditions	Rating	Unit	Note
Power Dissipation ⁽¹⁾	P_D	Lead temperature ⁽²⁾	5	W	SZ-10N27 SZ-10N40
			6		SZ-10NN27 SZ-10NN40
DC Blocking Voltage	V_{DC}	-	22	V	SZ-10N27 SZ-10NN27
			32		SZ-10N40 SZ-10NN40
Peak Surge Reverse Current	I_{RSM}	⁽³⁾	45	A	SZ-10N40
			70		SZ-10N27 SZ-10NN40
			90		SZ-10NN27
Junction Temperature	T_j	-	- 55 to 175	$^\circ\text{C}$	
Storage Temperature	T_{stg}	-	- 55 to 175	$^\circ\text{C}$	

⁽¹⁾ Refer to Figure 3-1 Power Dissipation Curves

⁽²⁾ Refer to Figure 1-1

⁽³⁾ Refer to Figure 1-2

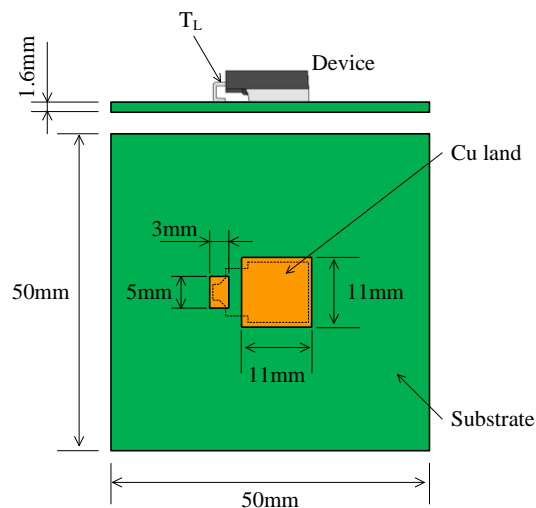

Figure 1-1 Lead temperature measurement condition

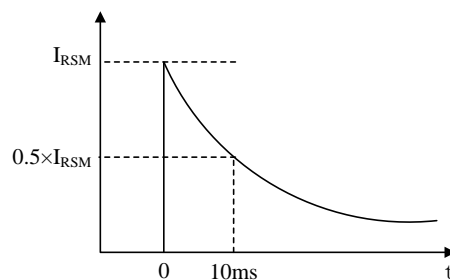

Figure 1-2 Definition of Peak Surge Reverse Current

SZ-10 Series

2. Electrical Characteristics

Unless specifically noted, $T_A = 25\text{ }^\circ\text{C}$.

Parameter	Symbol	Conditions	Min.	Typ.	Max.	Unit	Note
Forward Voltage Drop	V_F	$I_F = 6\text{ A}$	–	–	1.03	V	SZ-10N40
			–	–	1.00		SZ-10N27
			–	–	0.98		SZ-10NN40
			–	–	0.95		SZ-10NN27
Reverse Leakage Current	I_R	$V_R = V_{DC}$	–	–	10	μA	
Breakdown Voltage	V_Z	$I_Z = 10\text{ mA}$	24	–	30	V	SZ-10N27 SZ-10NN27
			36	–	44		SZ-10N40 SZ-10NN40
Breakdown Voltage Temperature Coefficient	r_Z	$I_Z = 10\text{ mA}$	–	22	–	$\text{mV}/^\circ\text{C}$	SZ-10N27 SZ-10NN27
			–	36	–		SZ-10N40 SZ-10NN40
Breakdown Region Equivalent Resistance	R_Z	$I_Z = 1\text{ A to } 10\text{ A}$	–	0.08	–	Ω	SZ-10N27 SZ-10NN27
			–	0.1	–		SZ-10N40 SZ-10NN40
Thermal Resistance	$R_{th(j-L)}$	⁽¹⁾	–	2.0	–	$^\circ\text{C}/\text{W}$	

⁽¹⁾ $R_{th(j-c)}$ is thermal resistance between junction and lead. Lead temperature is measured as shown Figure 1-1.

3. Performance Curves

3.1 Power Dissipation

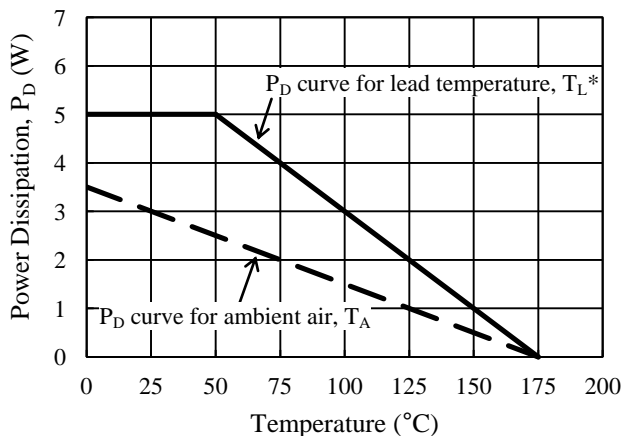

Figure 3-1 SZ10-N27 and SZ-10N40
Power Dissipation curves

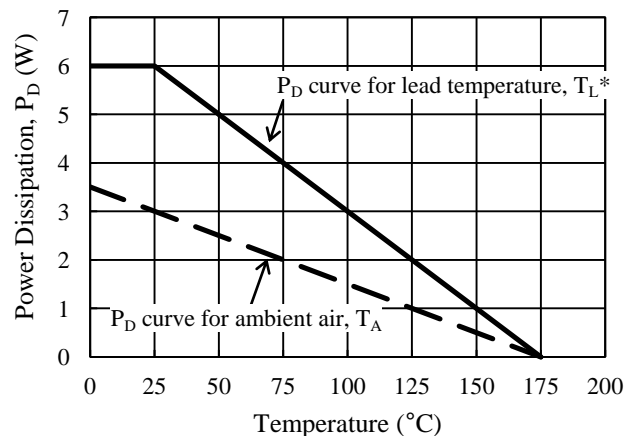

Figure 3-2 SZ10-NN27 and SZ-10NN40
Power Dissipation curves

* Refer to Figure 1-1

3.2 Peak Surge Reverse Power Capability

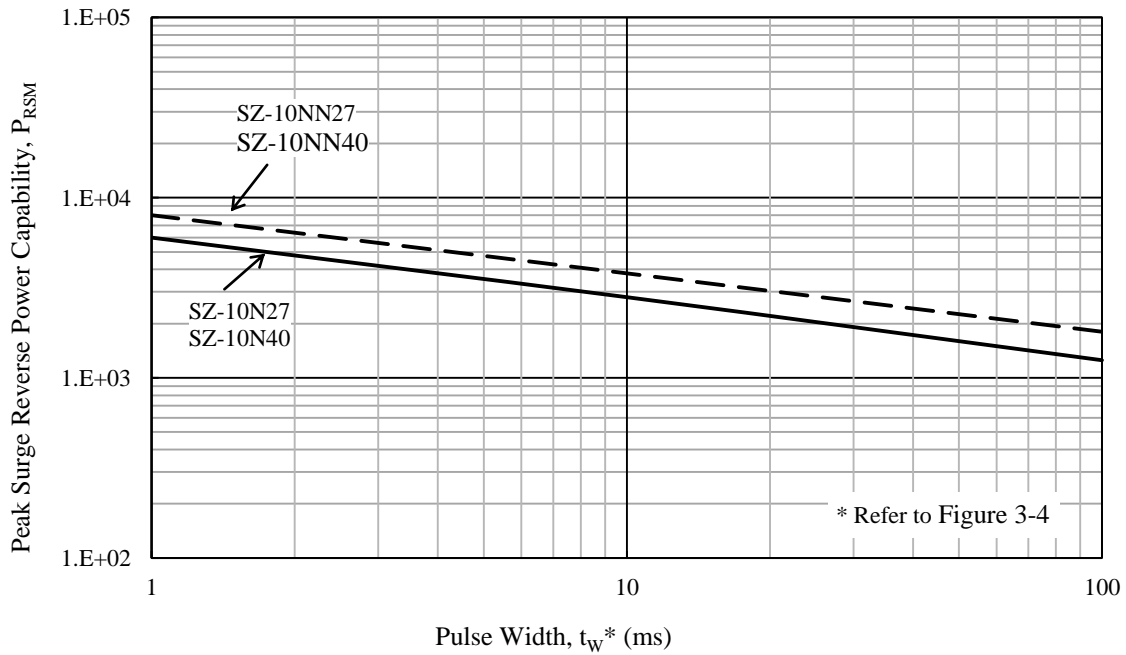

Figure 3-3 Peak surge reverse power capability

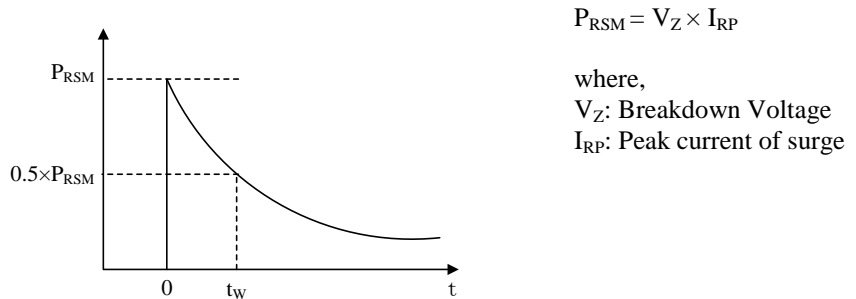

Figure 3-4 Definition of Peak Surge Reverse Power

3.3 SZ-10N27 Typical Characteristics

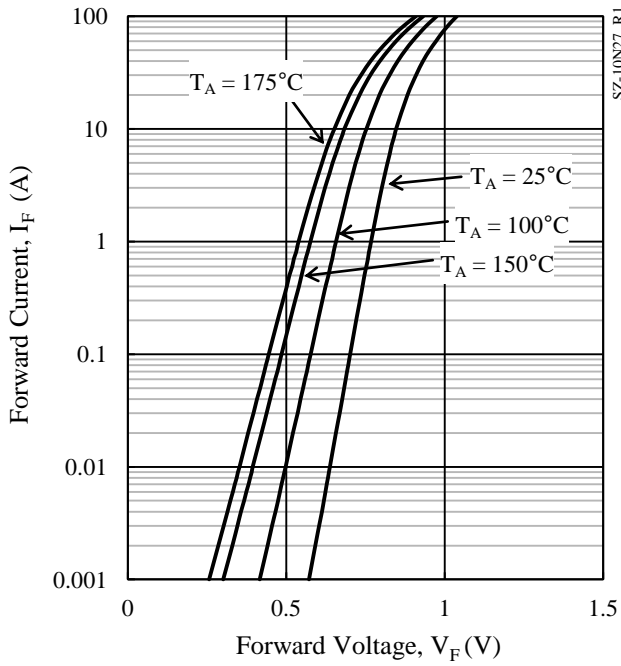

Figure 3-5 $I_F - V_F$ typical characteristics

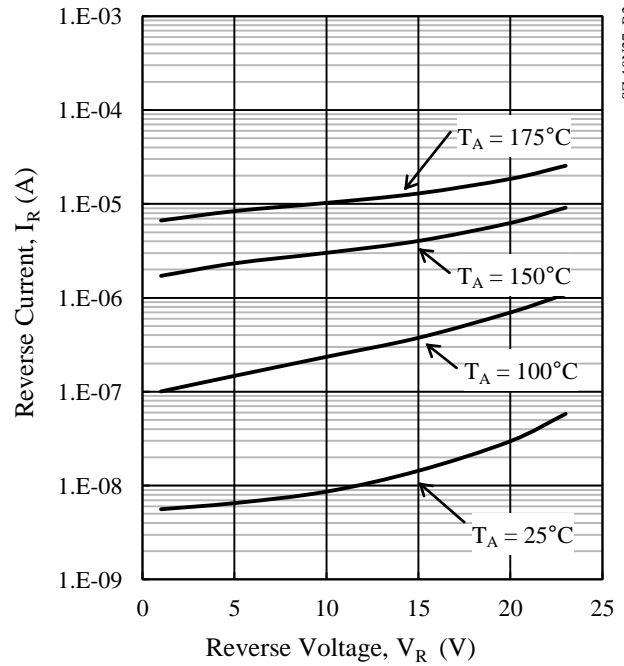

Figure 3-6 $I_R - V_R$ typical characteristics

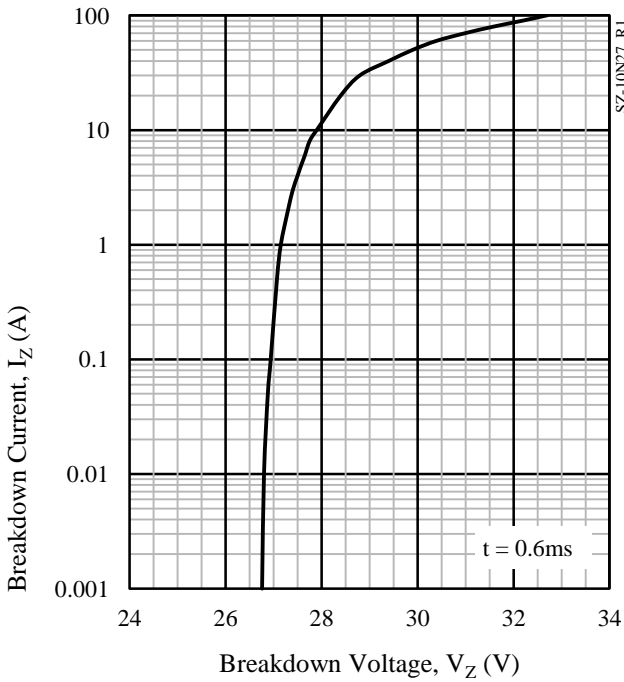

Figure 3-7 $I_Z - V_Z$ typical characteristics

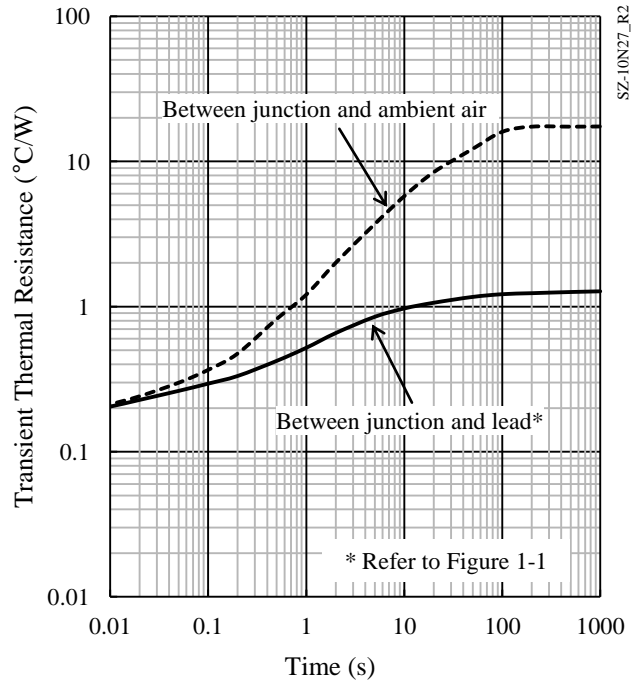

Figure 3-8 Typical transient thermal resistance

3.4 SZ-10NN27 Typical Characteristics

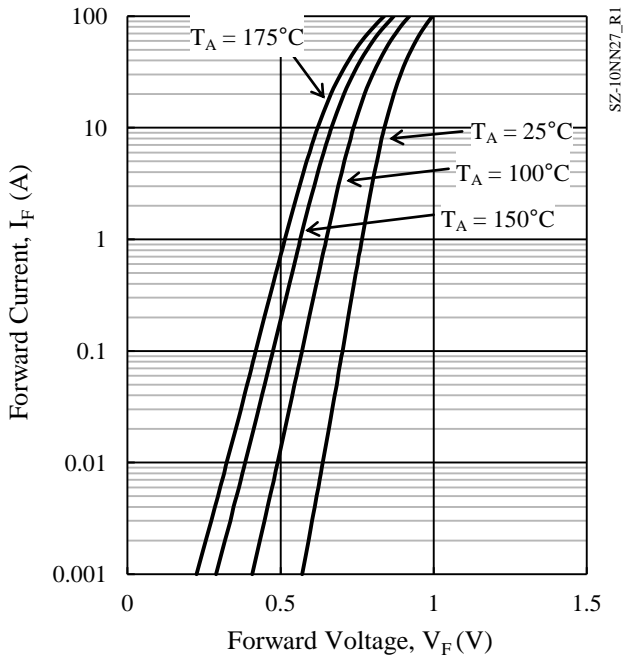

Figure 3-9 $V_F - I_F$ typical characteristics

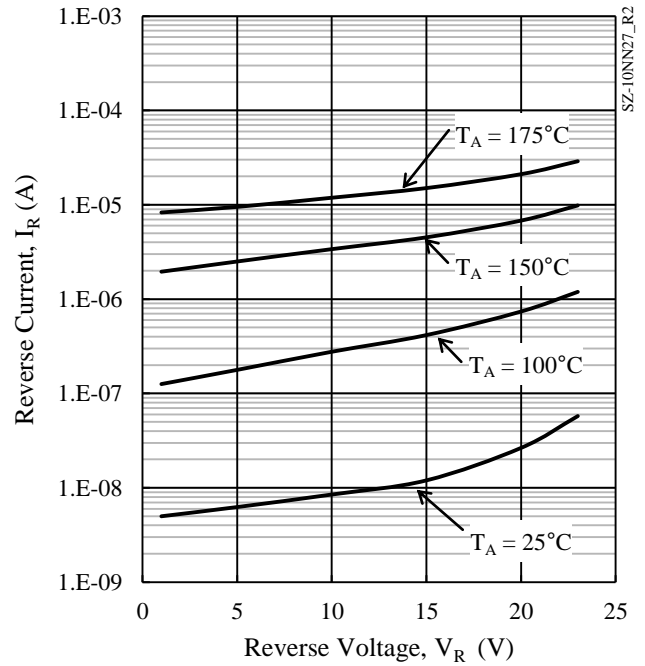

Figure 3-10 $V_R - I_R$ typical characteristics

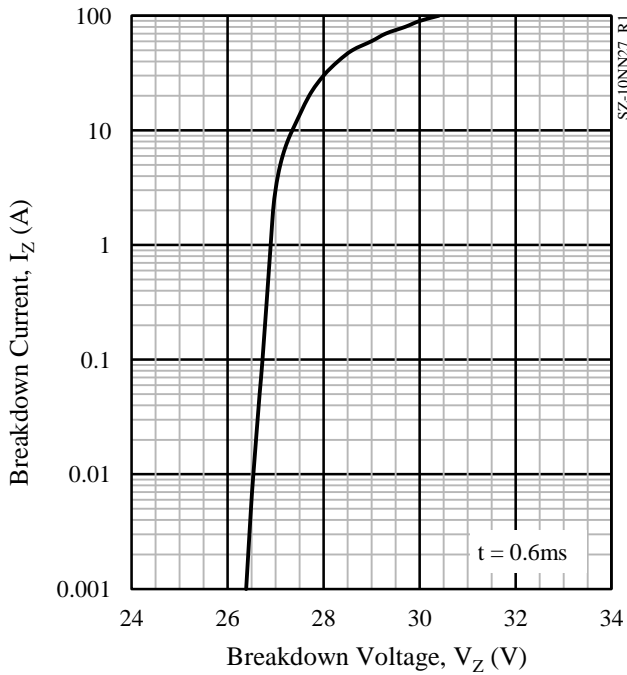

Figure 3-11 $I_Z - V_Z$ typical characteristics

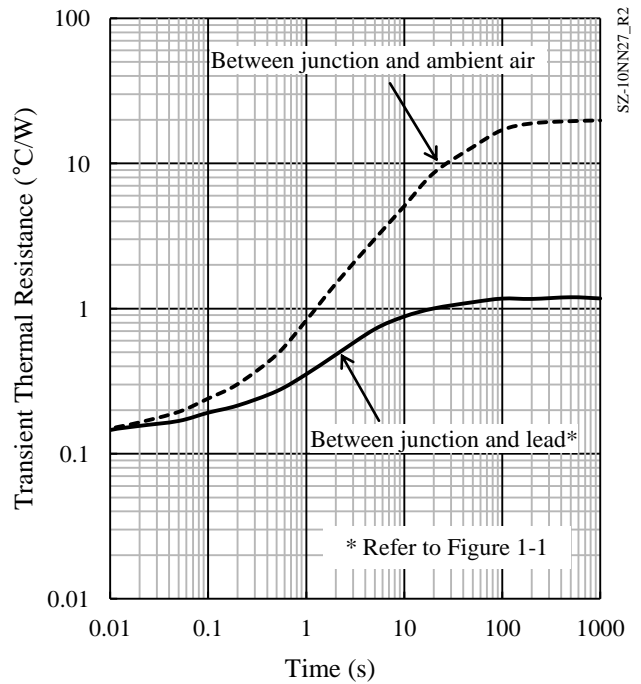

Figure 3-12 Typical transient thermal resistance

3.5 SZ-10N40 Typical Characteristics

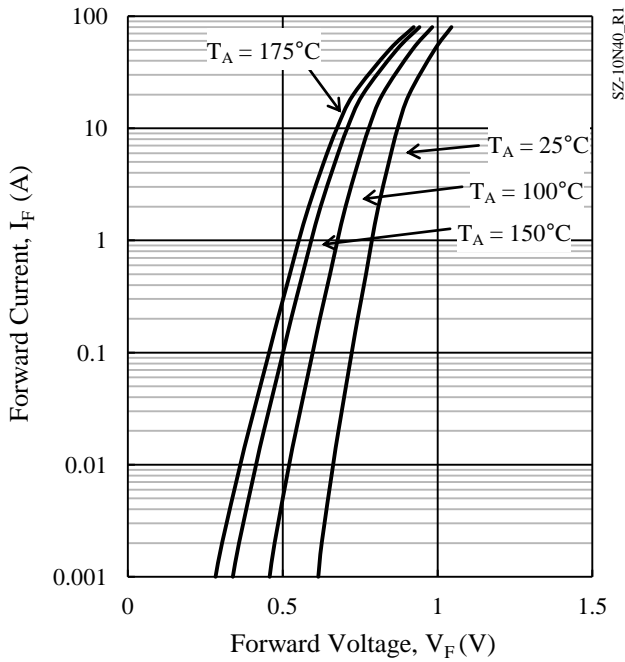

Figure 3-13 $V_F - I_F$ typical characteristics

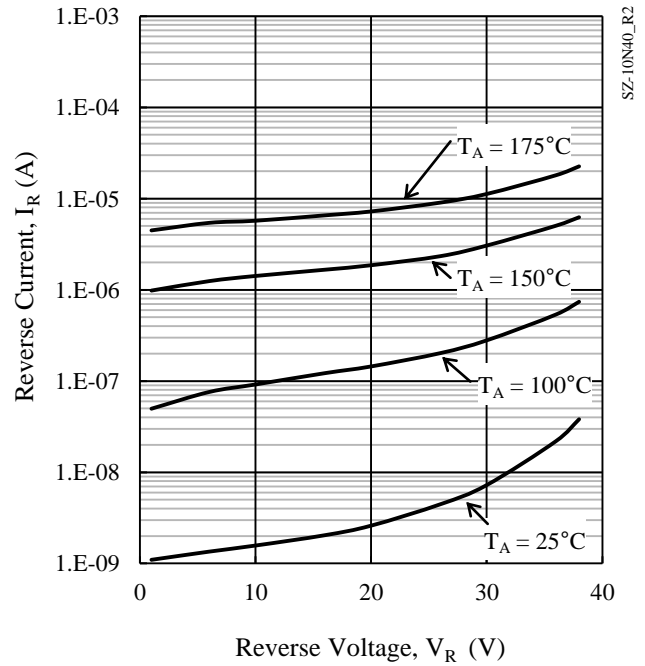

Figure 3-14 $V_R - I_R$ typical characteristics

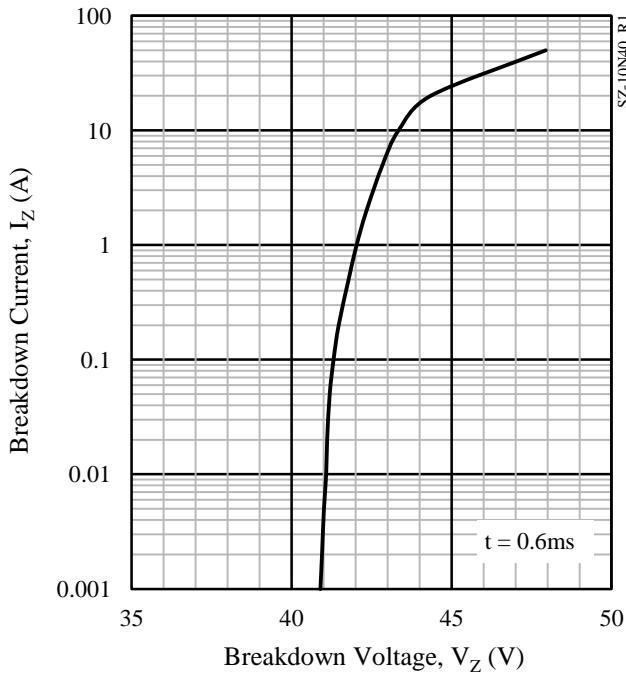

Figure 3-15 $I_Z - V_Z$ typical characteristics

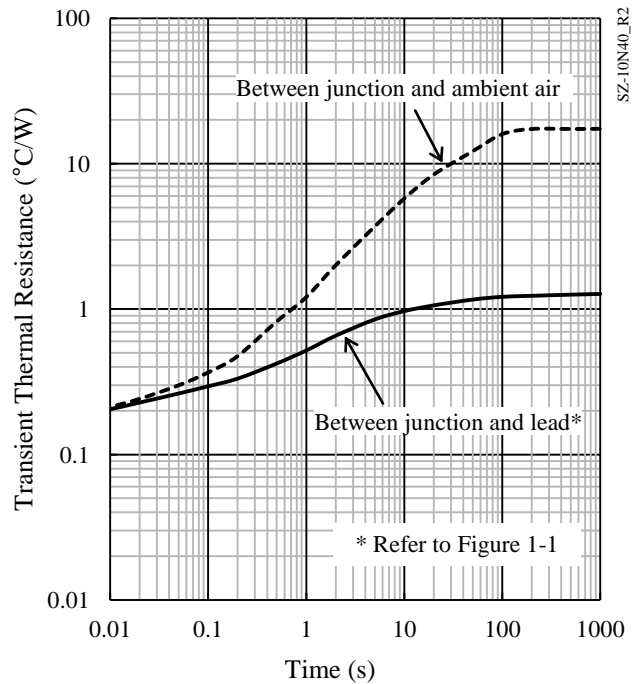

Figure 3-16 Typical transient thermal resistance

3.6 SZ-10NN40 Typical Characteristics

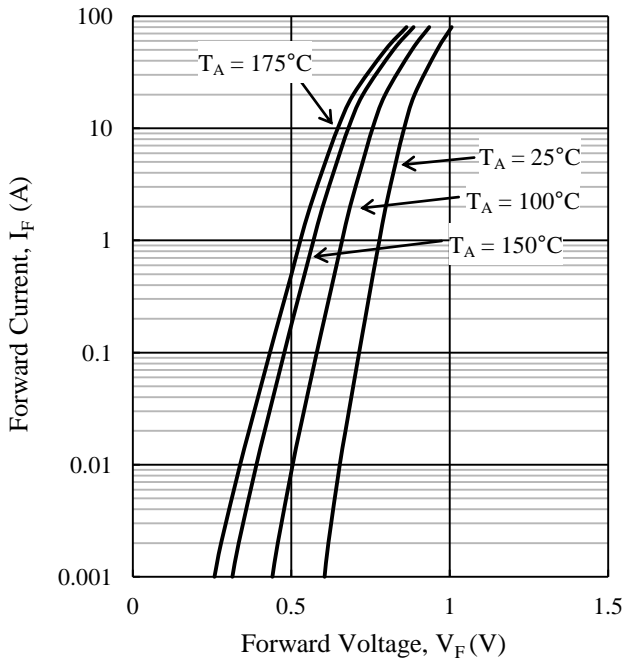

Figure 3-17 $V_F - I_F$ typical characteristics

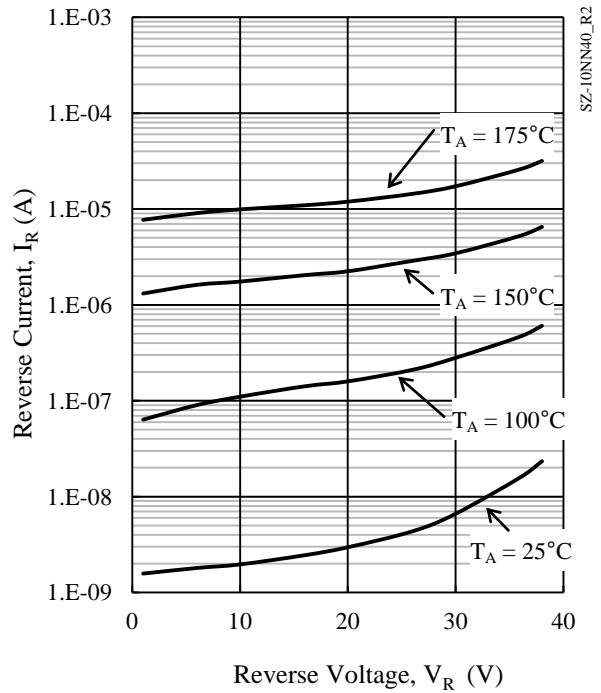

Figure 3-18 $V_R - I_R$ typical characteristics

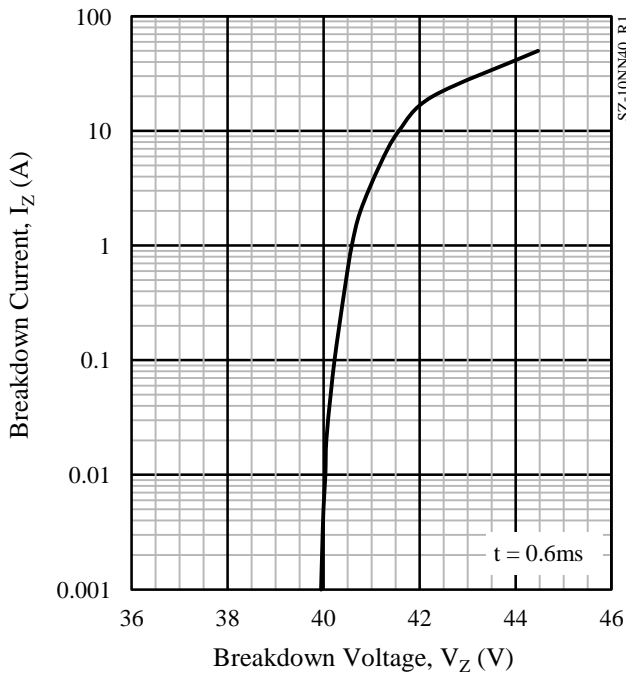

Figure 3-19 $I_Z - V_Z$ typical characteristics

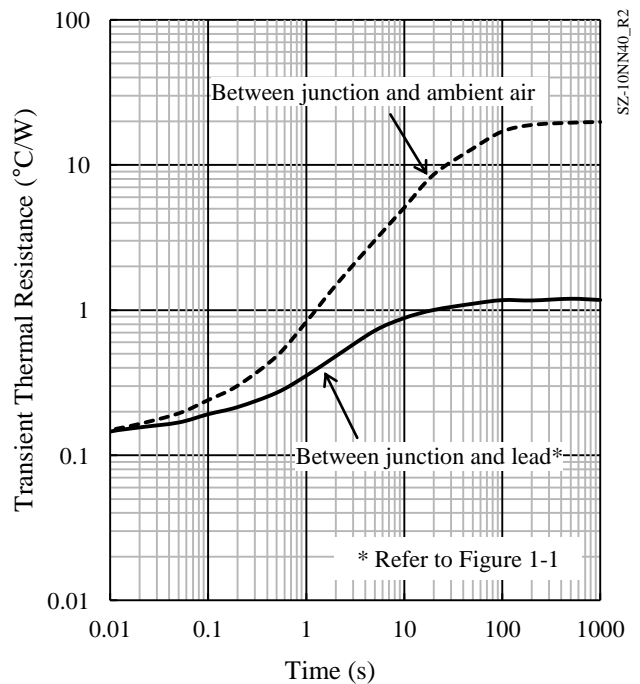
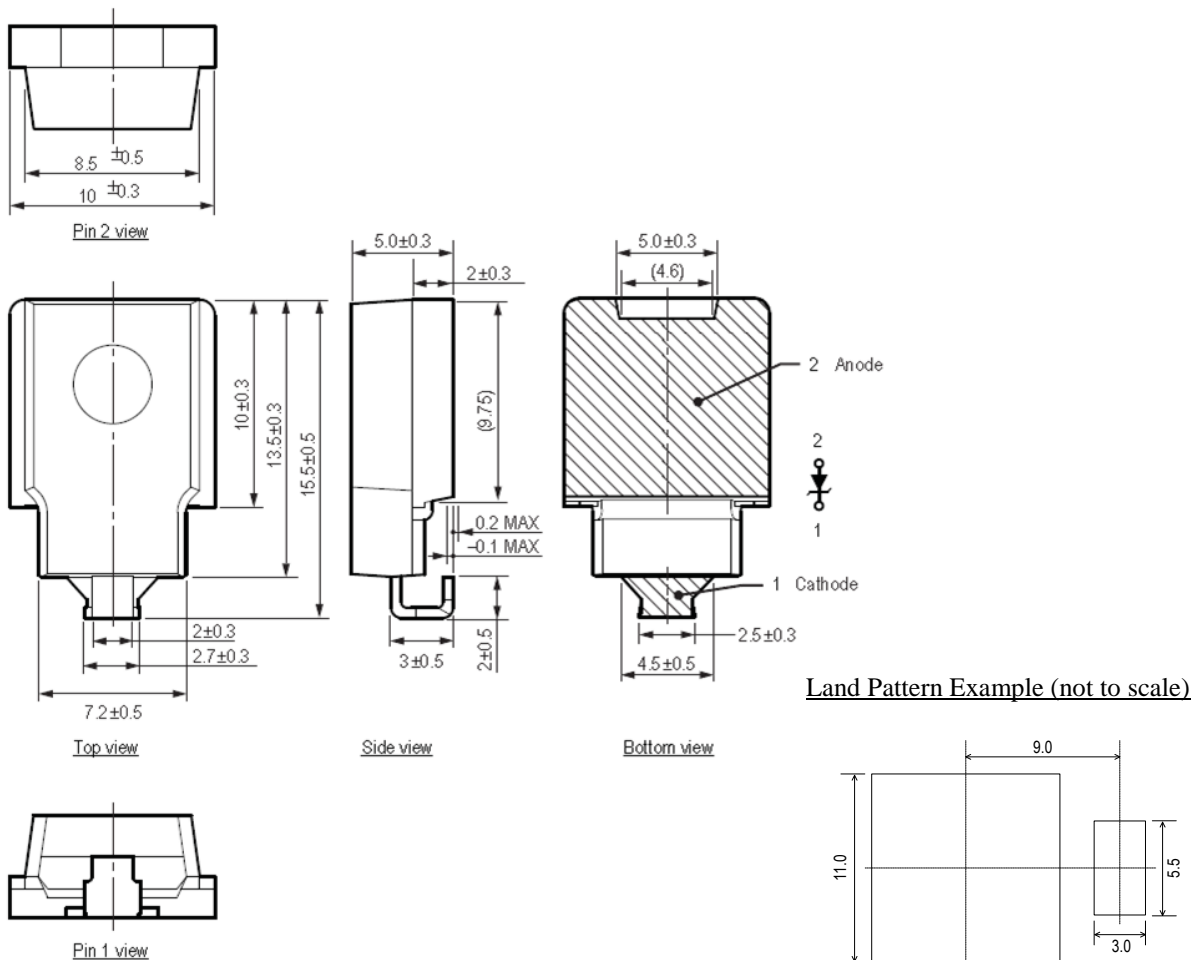

Figure 3-20 Typical transient thermal resistance

SZ-10 Series

4. External Dimensions

- SZ-10



NOTES:

- Dimension is in millimeters.
- Lead treatment Pb-free. Device composition compliant with the RoHS directive.
- MSL : JEDEC LEVEL3

5. Marking Diagram

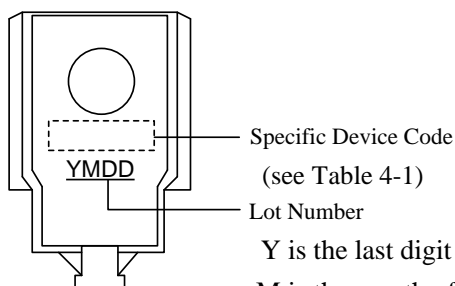

Y is the last digit of the year of manufacture (0 to 9)
M is the month of the year (1 to 9, O, N or D)
DD is the day of the month (01 to 31)

Table 4-1 Specific Device Code

Specific Device Code	Products
BN27	SZ-10N27
BN40	SZ-10N40
DN27	SZ-10NN27
DN40	SZ-10NN40

IMPORTANT NOTES

- All data, illustrations, graphs, tables and any other information included in this document as to Sanken's products listed herein (the "Sanken Products") are current as of the date this document is issued. All contents in this document are subject to any change without notice due to improvement, etc. Please make sure that the contents set forth in this document reflect the latest revisions before use.
- The Sanken Products are intended for use as components of electronic equipment or apparatus (transportation equipment and its control systems, home appliances, office equipment, telecommunication equipment, measuring equipment, etc.). Prior to use of the Sanken Products, please put your signature, or affix your name and seal, on the specification documents of the Sanken Products and return them to Sanken. If considering use of the Sanken Products for any applications that require higher reliability (traffic signal control systems or equipment, disaster/crime alarm systems, etc.), you must contact a Sanken sales representative to discuss the suitability of such use and put your signature, or affix your name and seal, on the specification documents of the Sanken Products and return them to Sanken, prior to the use of the Sanken Products. Any use of the Sanken Products without the prior written consent of Sanken in any applications where extremely high reliability is required (aerospace equipment, nuclear power control systems, life support systems, etc.) is strictly prohibited.
- In the event of using the Sanken Products by either (i) combining other products or materials therewith or (ii) physically, chemically or otherwise processing or treating the same, you must duly consider all possible risks that may result from all such uses in advance and proceed therewith at your own responsibility.
- Although Sanken is making efforts to enhance the quality and reliability of its products, it is impossible to completely avoid the occurrence of any failure or defect in semiconductor products at a certain rate. You must take, at your own responsibility, preventative measures including using a sufficient safety design and confirming safety of any equipment or systems in/for which the Sanken Products are used, upon due consideration of a failure occurrence rate or derating, etc., in order not to cause any human injury or death, fire accident or social harm which may result from any failure or malfunction of the Sanken Products. Please refer to the relevant specification documents and Sanken's official website in relation to derating.
- No anti-radioactive ray design has been adopted for the Sanken Products.
- No contents in this document can be transcribed or copied without Sanken's prior written consent.
- The circuit constant, operation examples, circuit examples, pattern layout examples, design examples, recommended examples and evaluation results based thereon, etc., described in this document are presented for the sole purpose of reference of use of the Sanken Products and Sanken assumes no responsibility whatsoever for any and all damages and losses that may be suffered by you, users or any third party, or any possible infringement of any and all property rights including intellectual property rights and any other rights of you, users or any third party, resulting from the foregoing.
- All technical information described in this document (the "Technical Information") is presented for the sole purpose of reference of use of the Sanken Products and no license, express, implied or otherwise, is granted hereby under any intellectual property rights or any other rights of Sanken.
- Unless otherwise agreed in writing between Sanken and you, Sanken makes no warranty of any kind, whether express or implied, as to the quality of the Sanken Products (including the merchantability, or fitness for a particular purpose or a special environment thereof), and any information contained in this document (including its accuracy, usefulness, or reliability).
- In the event of using the Sanken Products, you must use the same after carefully examining all applicable environmental laws and regulations that regulate the inclusion or use of any particular controlled substances, including, but not limited to, the EU RoHS Directive, so as to be in strict compliance with such applicable laws and regulations.
- You must not use the Sanken Products or the Technical Information for the purpose of any military applications or use, including but not limited to the development of weapons of mass destruction. In the event of exporting the Sanken Products or the Technical Information, or providing them for non-residents, you must comply with all applicable export control laws and regulations in each country including the U.S. Export Administration Regulations (EAR) and the Foreign Exchange and Foreign Trade Act of Japan, and follow the procedures required by such applicable laws and regulations.
- Sanken assumes no responsibility for any troubles, which may occur during the transportation of the Sanken Products including the falling thereof, out of Sanken's distribution network.
- Although Sanken has prepared this document with its due care to pursue the accuracy thereof, Sanken does not warrant that it is error free and Sanken assumes no liability whatsoever for any and all damages and losses which may be suffered by you resulting from any possible errors or omissions in connection with the contents included herein.
- Please refer to the relevant specification documents in relation to particular precautions when using the Sanken Products, and refer to our official website in relation to general instructions and directions for using the Sanken Products.